

ADVANCED SIMRACING

# ASR6 ASSEMBLY GUIDE



NOT A RENDER



Tools  
- measuring tape  
- allen key 3/16

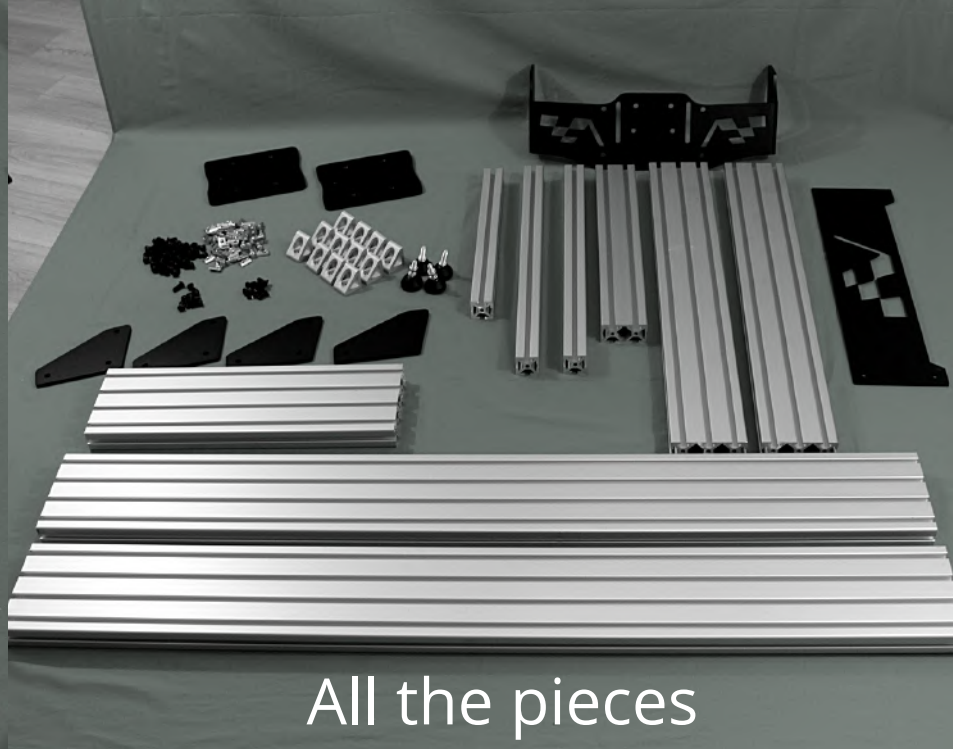

All the pieces

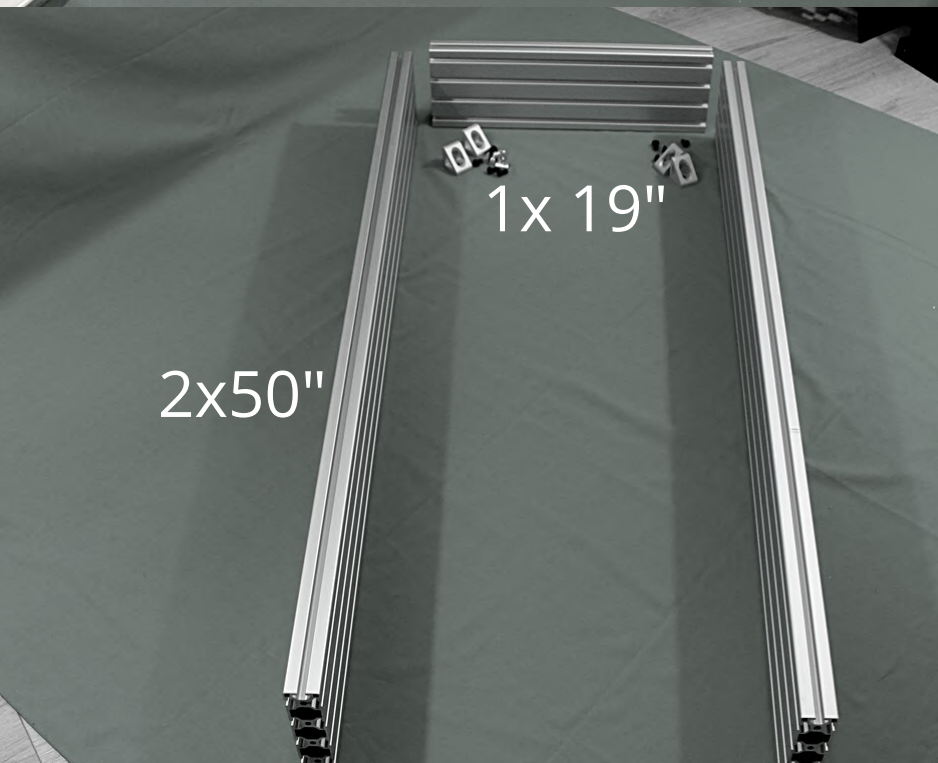

2x50"

1x19"

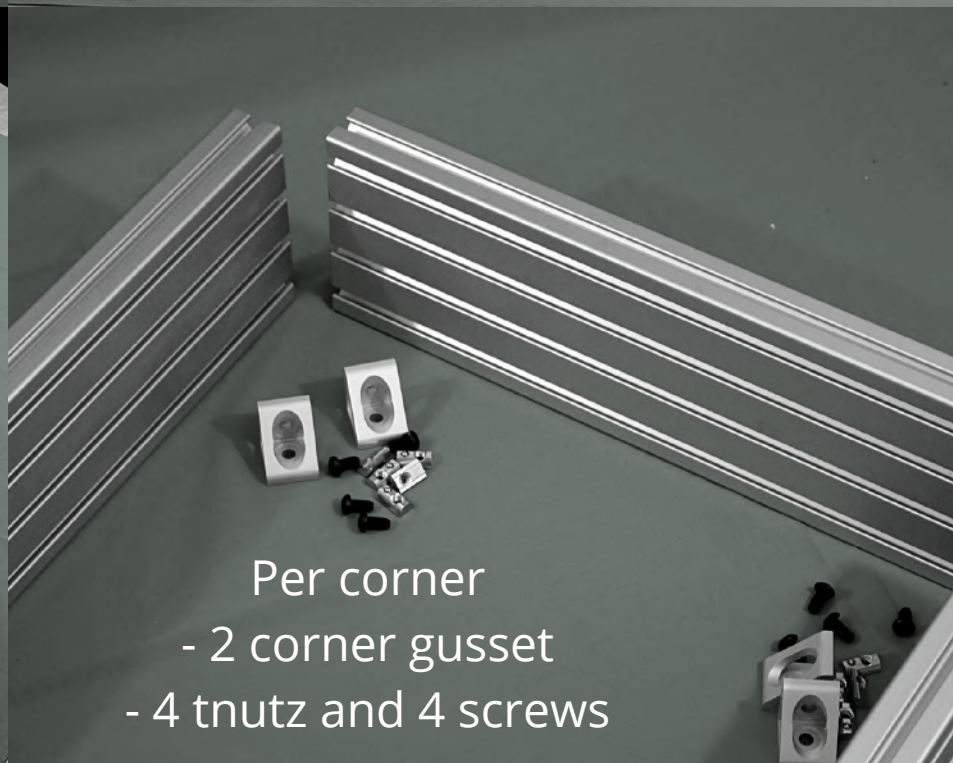

Per corner  
- 2 corner gusset  
- 4 nutz and 4 screws





Put screws and t-nutz in corner gusset. leave enough space to slide in aluminum

Do not tighten gusset. slide the 19" bar

Slide the "T" into the slot

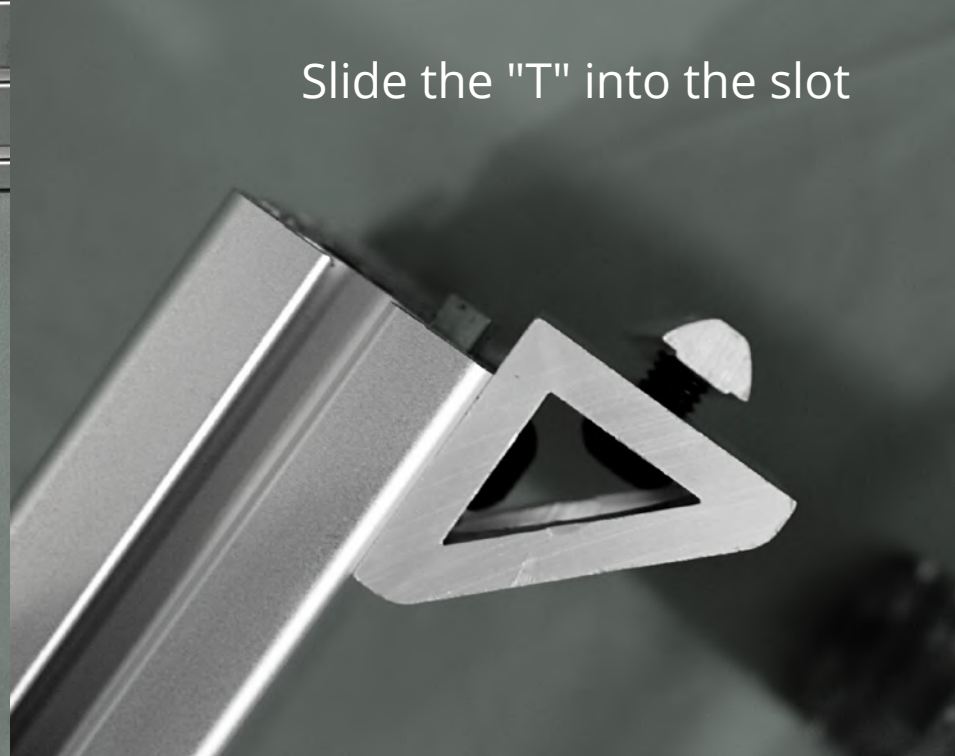

Once everything is aligned, tighten all screws.





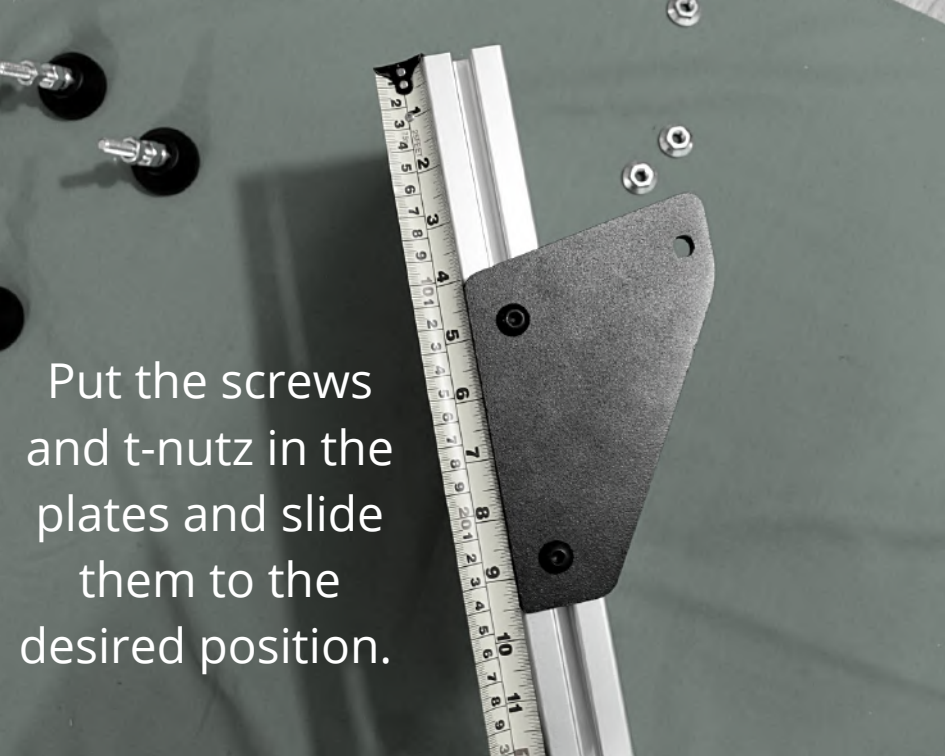

Prepare all 4 legs  
and plates.

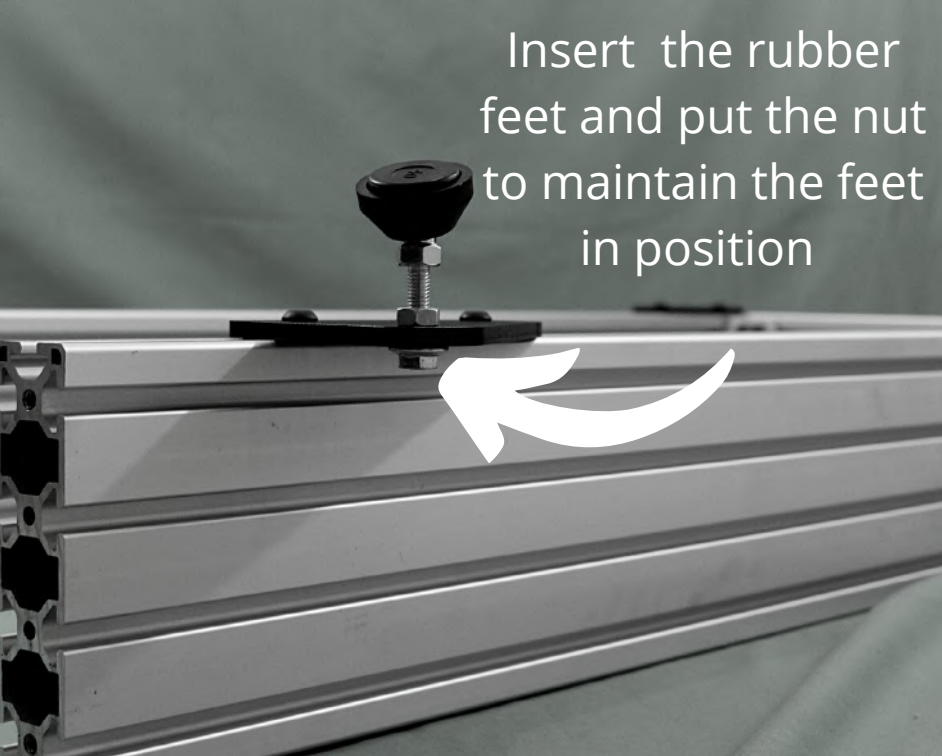

Put the screws  
and t-nutz in the  
plates and slide  
them to the  
desired position.



Insert the rubber  
feet and put the nut  
to maintain the feet  
in position



Once all for corners  
are done, flip it over.





Time for the  
side posts

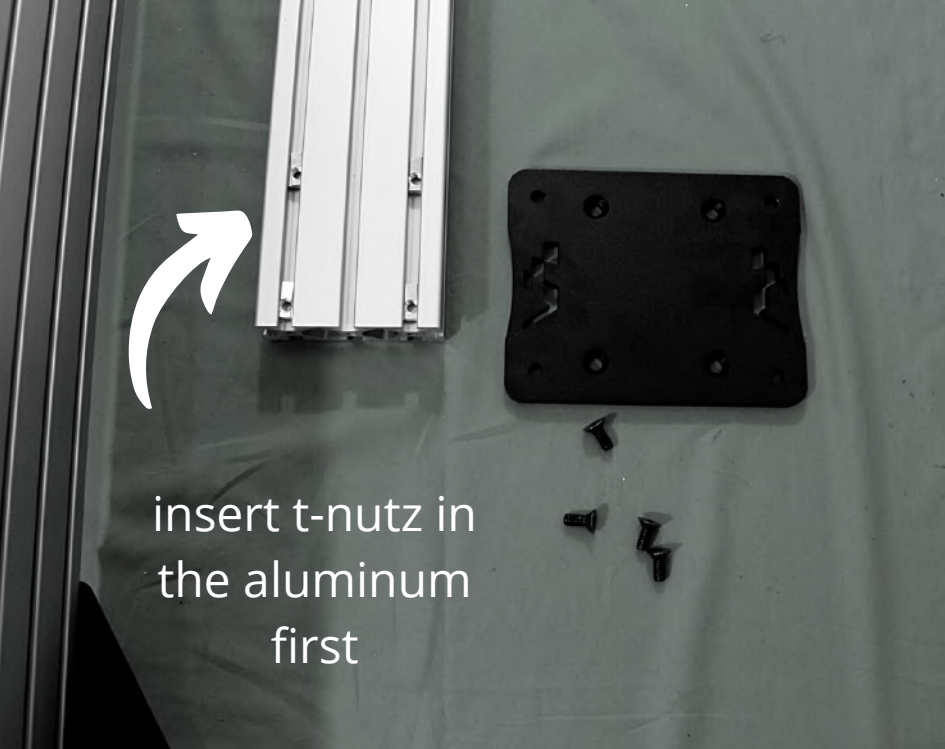

insert t-nutz in  
the aluminum  
first



Screw the  
thick plate  
onto the post







Insert the t-nutz  
in the first and  
last slot

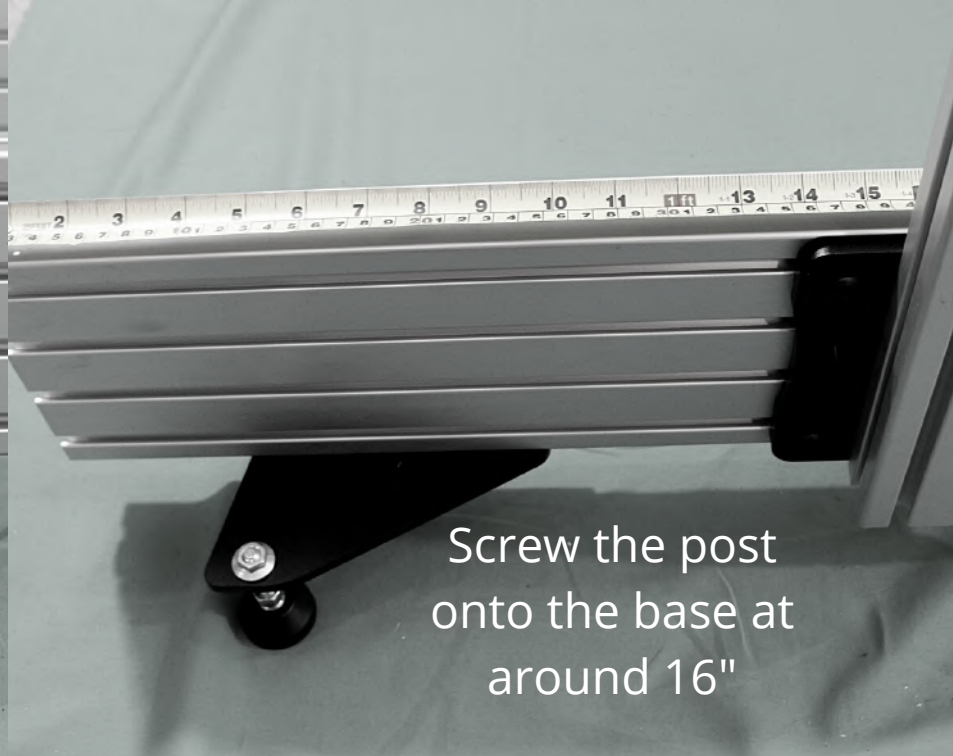

Screw the post  
onto the base at  
around 16"



Here you go!





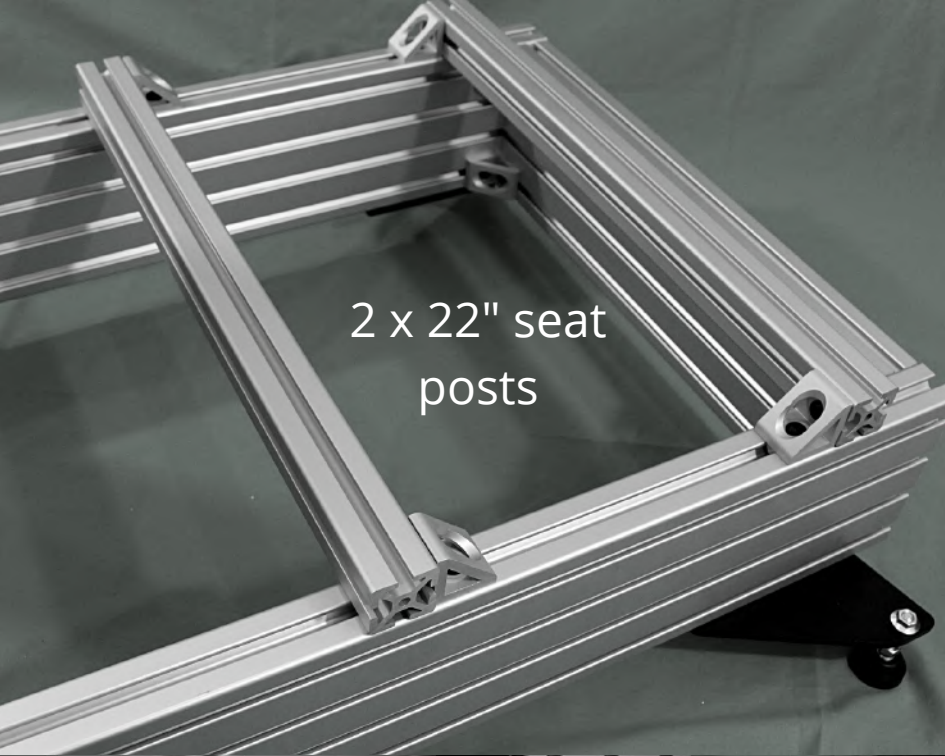

2 x 22" seat posts



Don't tighten these right away

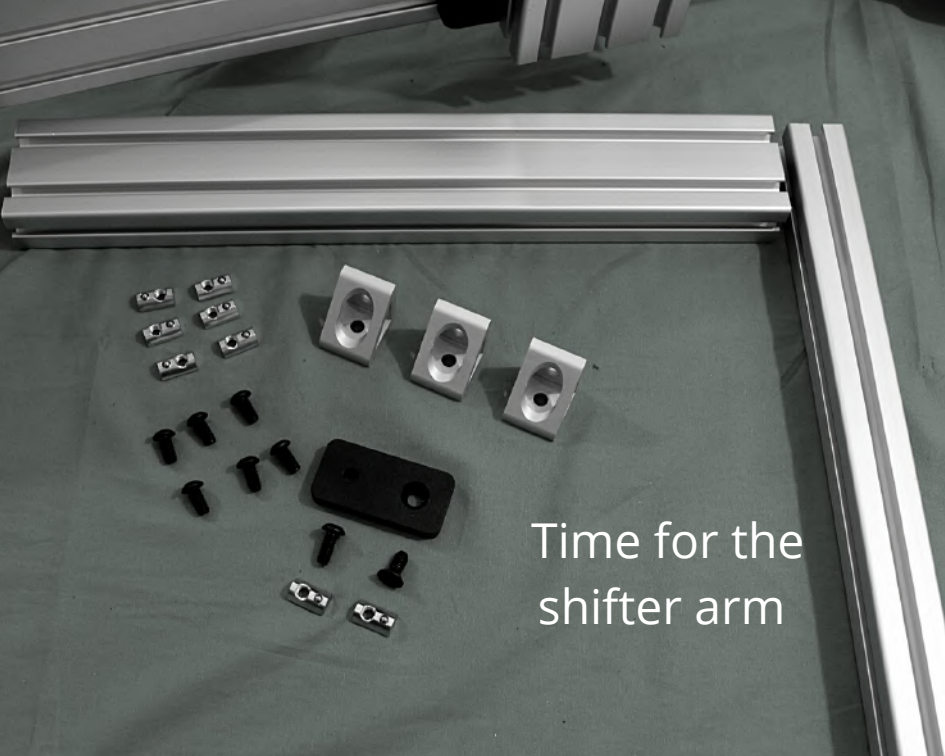

Time for the shifter arm

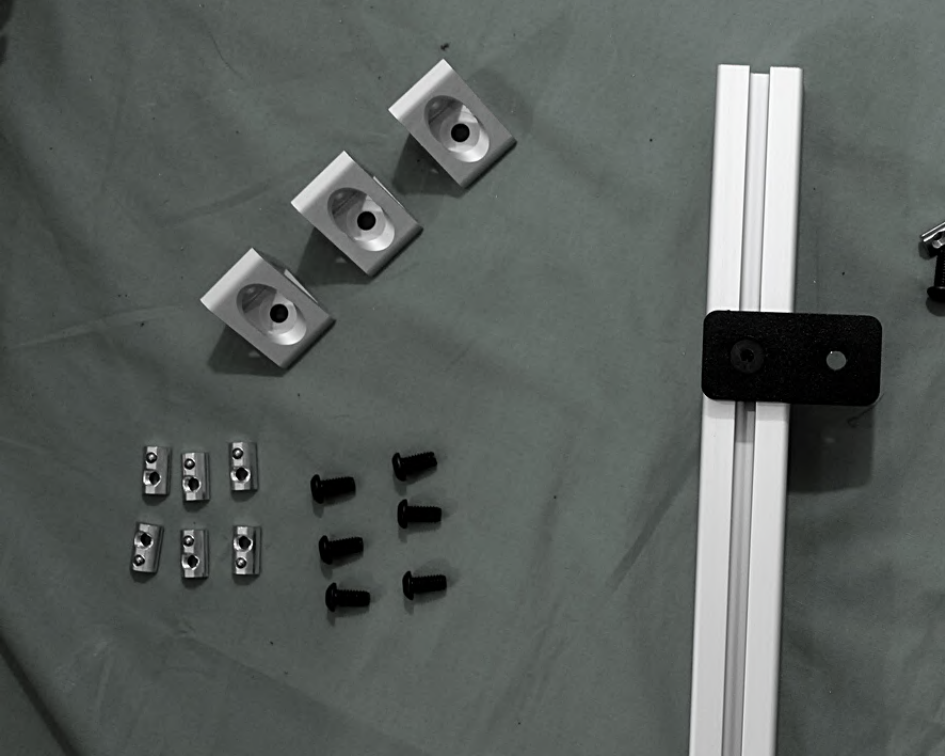



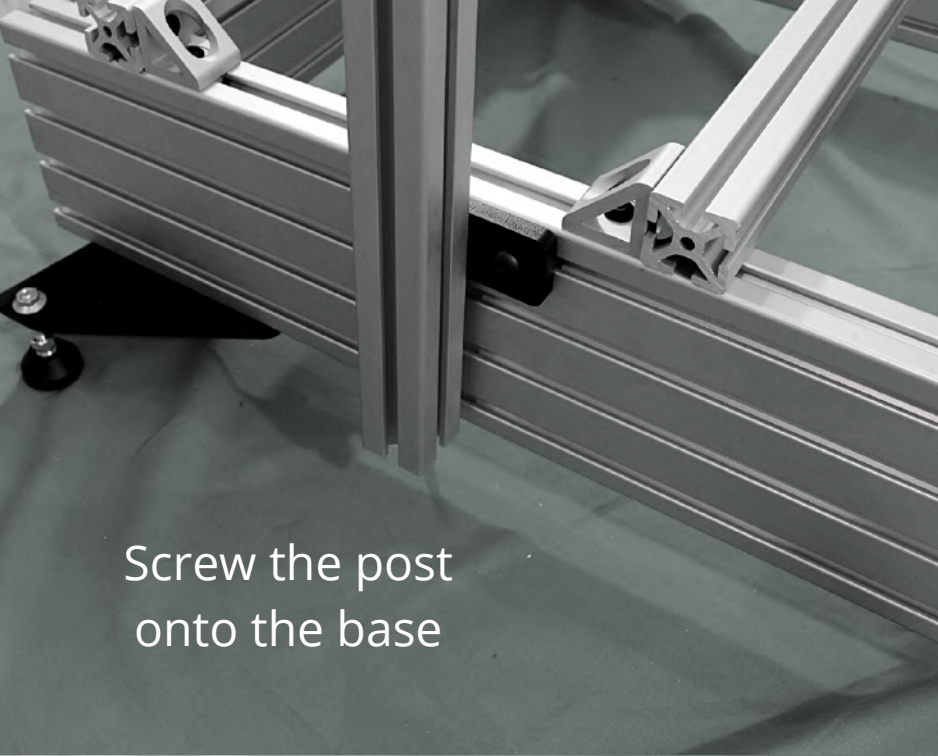

Screw the post  
onto the base



Screw the upper  
aluminum bar



Once to the  
desired position,  
tighen  
everything





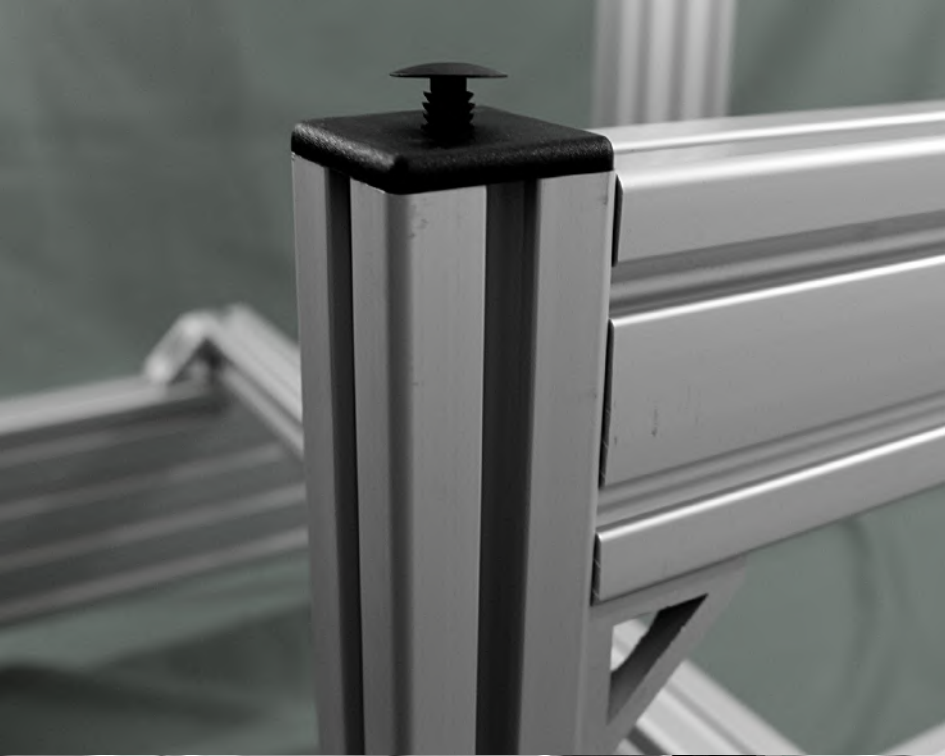

Now you can  
put the plastic  
end caps...OR...  
wait till the end  
as it's a bit  
more satisfying

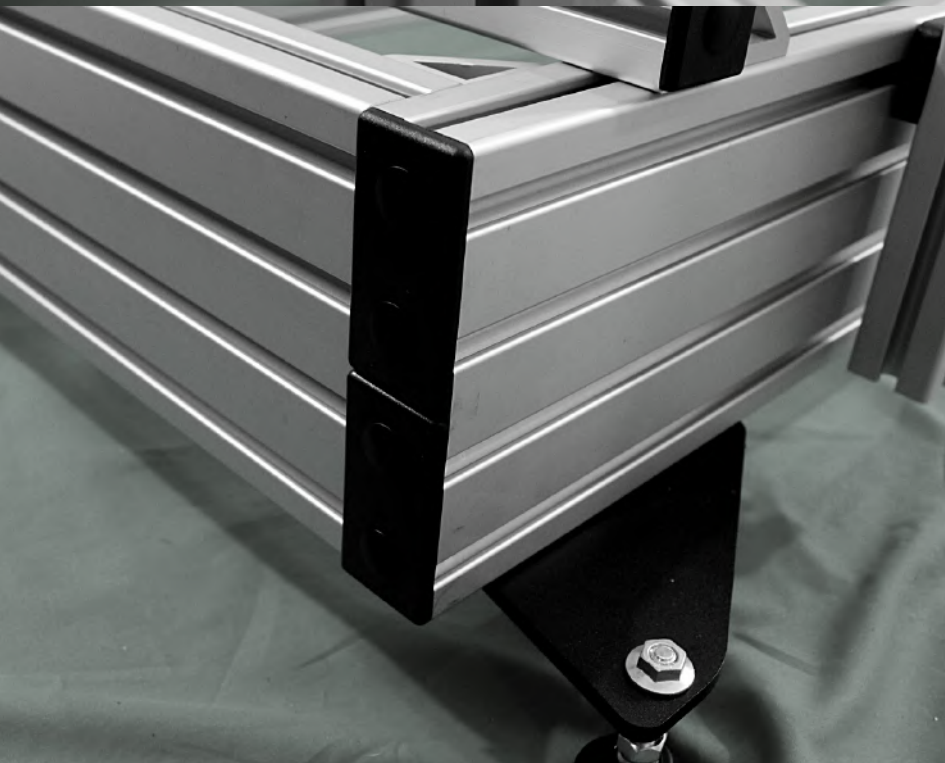

Time to install  
the wheel deck

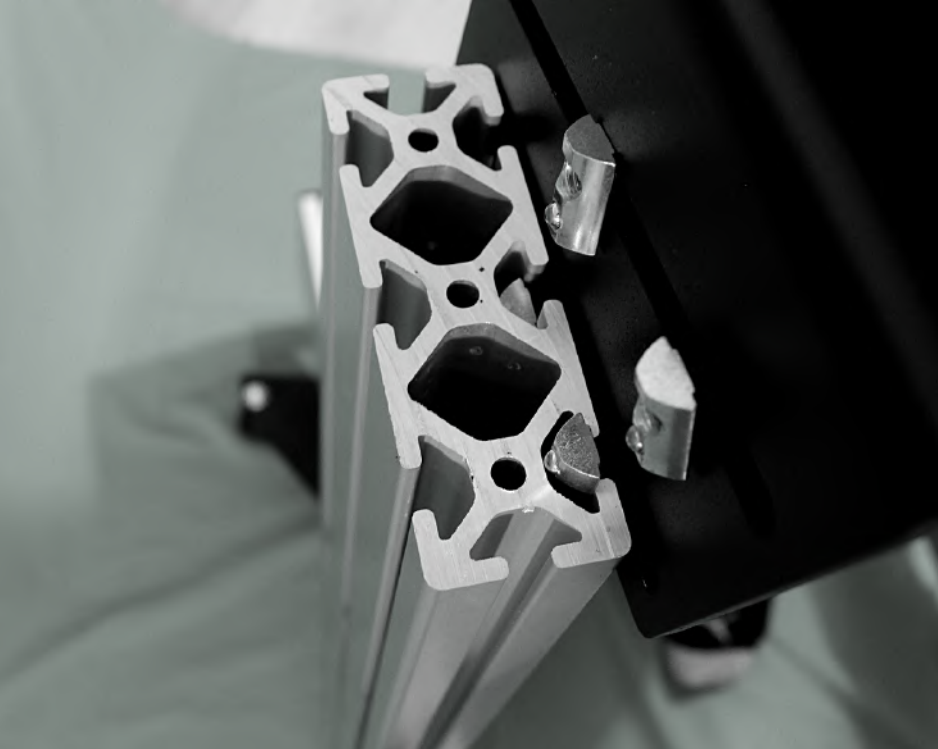

Slide in the  
wheel deck

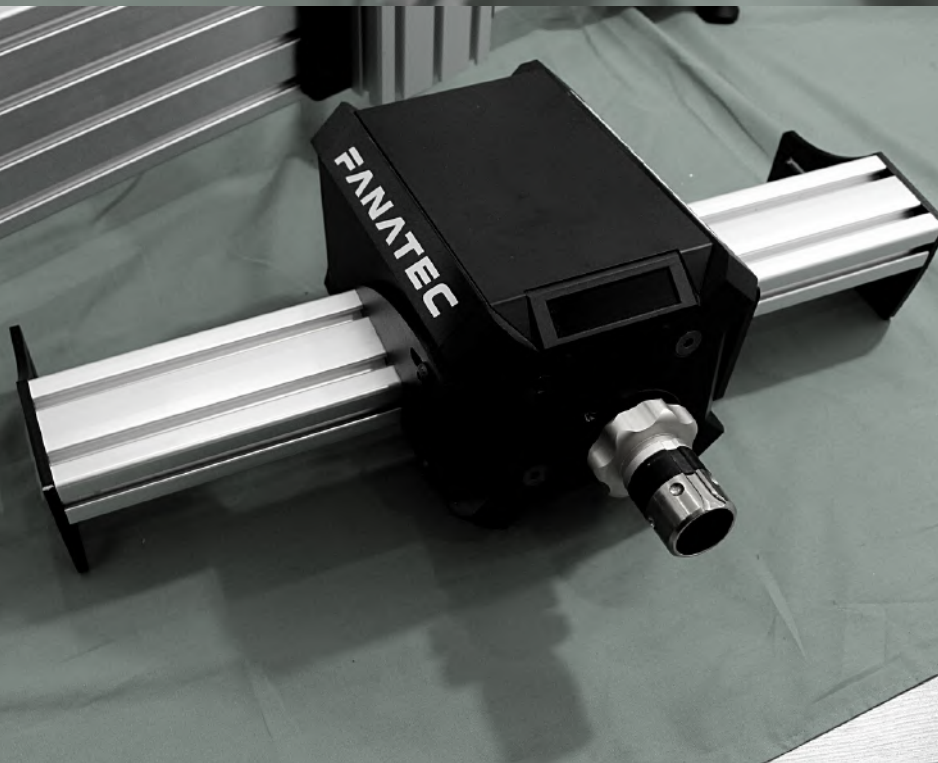

For the DD  
base, install the  
add-on to your  
fanatec first  
then slide in  
the side posts.





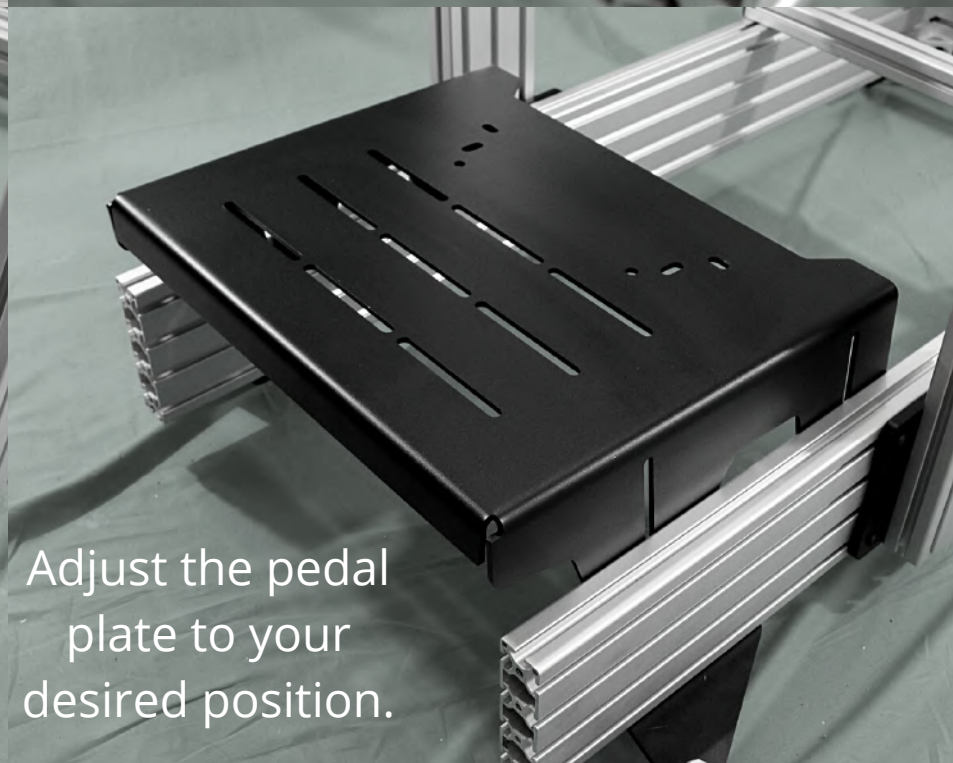
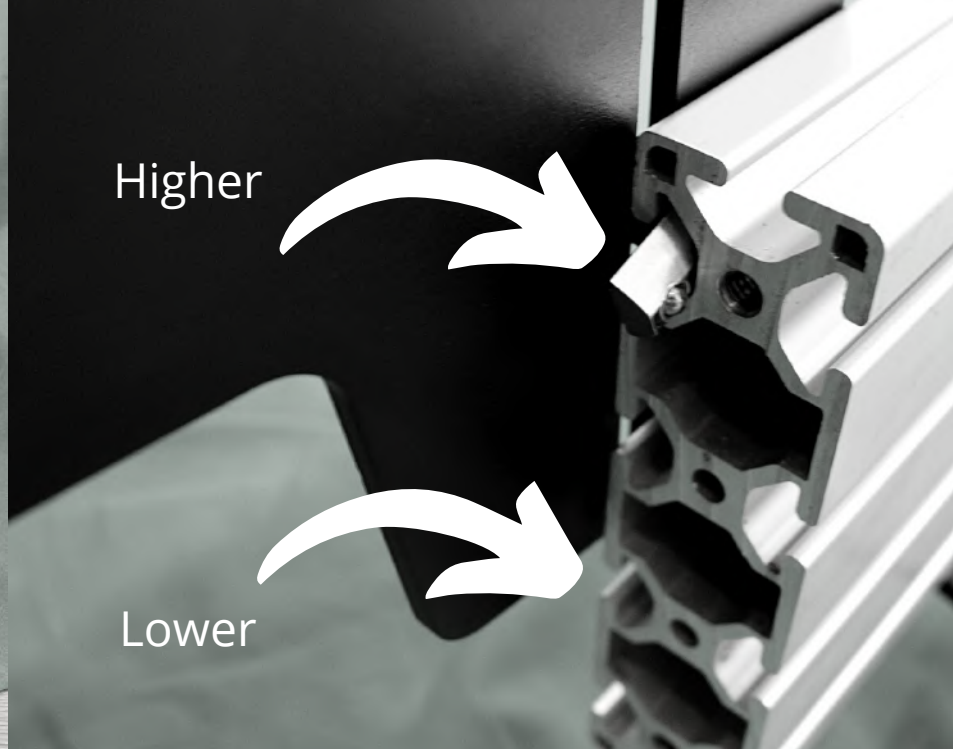



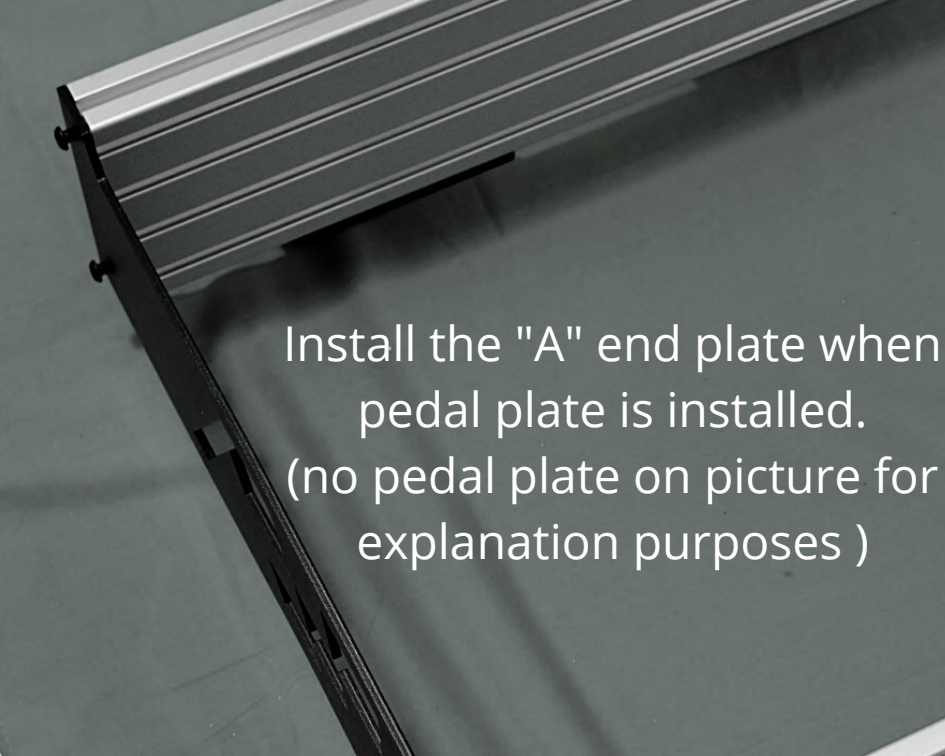
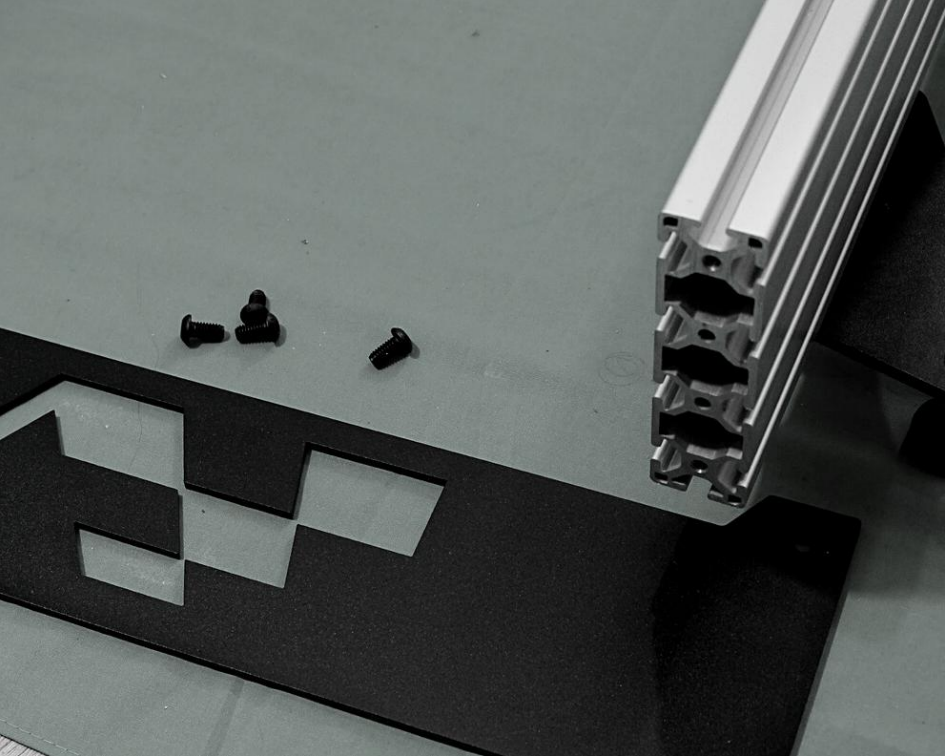

Install the "A" end plate when pedal plate is installed.  
(no pedal plate on picture for explanation purposes )