

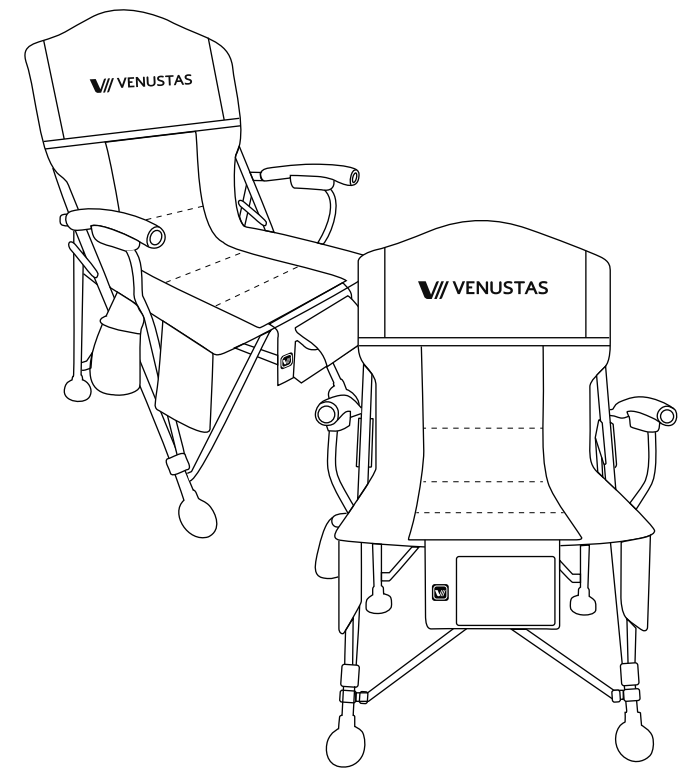

## USER MANUAL **HEATED CHAIR**



# VENUSTAS

Service@venustasofficial.com

+1 888 836 6460

www.venustasofficial.com



@VenustasOfficial



@venustas.official



@venustas.official

## Our Story

Founded in 2018 we are on a mission to develop accessible products that does not limit us to any environment. We believe that the world is your oyster. Ready to be explored in any condition to uncover the beautiful wonders of life.

Our story began when my wife and I took a trip to the Rocky Mountains of Colorado. The conditions were cold, and we knew we had a challenge on our hands. The harsh climate was made worse by the many layers of clothing we had to wear just to keep warm. Fatigue set in and I could visibly see that my wife was no longer having a good time. While the reward of adventure is made all the sweeter through the trials and tribulations along the journey, all I could think of during that hike was how could I set free my wife's beauty amidst her struggles with the environment.

I decided to work on a prototype jacket that'd allow my wife to be free from all cumbersome layers of clothing, so that she could enjoy the journey just as much as the destination. I recalled the Colorado climb and inspired by Botticelli's the Birth of Venus, named it Venustas.

We took a jacket and worked on many prototypes until we landed on what you see today. Our bestselling product, our Men's Heated Jacket with integrated 7.4V battery pack, is an insulated, windproof coat with a detachable hood. Its success had a snowball effect and has led us to go beyond heated jackets and into the Venustas innovation lab. Venustas is constantly developing new offerings that best fit your adventurous world.

We believe that everyone deserves great products that are affordable. This is why we are proud to open up our platform for your feedback. We strive for excellence and customer satisfaction. Without the adventurers, travelers and explorers there would not be a curious world waiting to be discovered.

**Live Without Limits**

## Activate Your Warranty



Register at [www.venustasofficial.com](http://www.venustasofficial.com) for:



1 year limited warranty for free



Exclusive offers, deals and more



Tips to make the most of your heated experience

How to Register at [www.venustasofficial.com](http://www.venustasofficial.com)

- Visit [www.venustasofficial.com](http://www.venustasofficial.com), then click "Warranty Policy" at the bottom.
- Or scan the upper right QR code with your mobile phone.

If you have any problems or you are not 100% satisfied with the product, please feel free to contact us. We will try our best to offer you a satisfactory solution.



## Need Help?

**We're here to help!**



**service@venustasofficial.com** (7\*24H, 365 Days)



**+1 888-836-6460** (10am to 5pm EST, Monday to Friday)

Follow us on social media channel for the latest news, promotions and prompt feedback.



@VenustasOfficial



@venustas.official



@venustas.official

# Package List

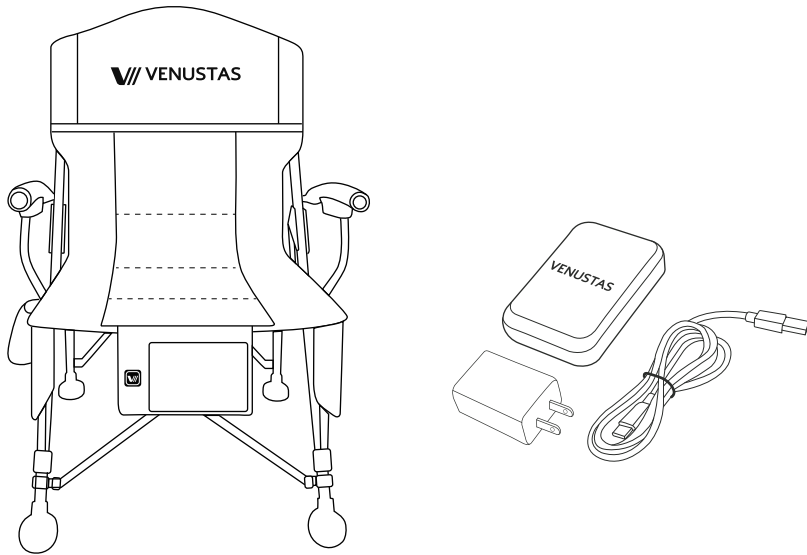

1x HEATED CHAIR

1x BATTERY AND CHARGER

Note: Please check the package list, if some items are missing, please CONTACT us with your Amazon order ID and shipping information, we will process it within 1 day.

 [service@venustasofficial.com](mailto:service@venustasofficial.com)



## WARNING

Read all safety warnings and instructions, including those given in the attached brochure. Failure to follow warnings and instructions may result in electric shock, fire, or serious injury. Keep the user manual for future reference.

# Operation Instruction

**1** Insert the power cable (located in the inside pocket) into the port on the battery. The POWER BUTTON on your chair will flash in red light and then turn off (if not, please re-plug).

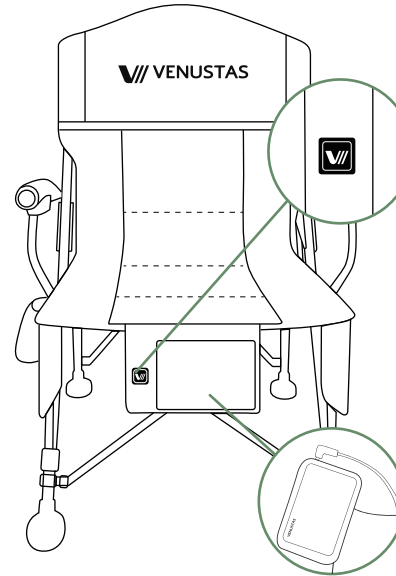

**2** To turn on, press and hold the power button for 3-5 seconds. The chair will begin to preheat for 5 minutes (blinking red LED).









Then it will automatically adjust to medium heat (white LED)

**3** To turn off, press and hold the power button for 3-5 seconds until LED turns off.

**4** Unplug the battery if not to be used for a long time.

The heating level can be adjusted by pressing the power button for 1s. Each pressing will cycle through the chair's temperature settings. At room temperature, the heat will rise to 130° F/55° C at high-heat levels, 113° F/45° C at medium, and 100° F/37° C at low.

Note: The temperature is regulated at the internal heating element. The temperature you feel may be slightly lower.

	 130°F 55°C		 130°F 55°C		 113°F 45°C		 100°F 37°C
Pre-Heat Red LED Blinking		High Red LED		Medium White LED		Low Blue LED	

## Cleaning Instruction



Before washing chair, disconnect and remove the battery, put the plug back.

**DO NOT IRON**  
**NO NOT DRY CLEAN**

**DO NOT BLEACH**  
**DO NOT WRING OR TWIST**  
**LINE DRY**

## Battery Instruction

### Specifications

Capacity	5000mAh (37Wh)
Input	Type-C 5V/2.1A
Output	DC 7.4V/2.1A; USB 5V/2.1A
Weight	6.88 oz



**Capacity**  
7.4V 5000 Mah



**USB TYPE-C to**  
charge any device



**Fully charge before first use.**



**Fully charge every 3 months.**



Recommended operating temperature of 14° F to 86° F (-10°C to 30°C).  
Store the battery pack where the temperature is 77± 2° F (25± 2°C).



**DO NOT** expose to liquids.



**DO NOT** disassemble.



Avoid dropping.



Keep the battery away from moisture.  
Store the battery pack where the relative humidity is 60+ 15% RH.

### How to charge the battery

1. Remove battery from chair before charging and connect battery with charger.
2. Plug the charger on the wall, it often takes 6-7 hours to be fully charged.

## Safety Instruction



### WARNING

Chair is used for keeping a person warm in cold environments. **DO NOT** use this product in any other way as stated for normal use.

**DO NOT** use this chair with an infant, child, a helpless person, or anyone insensitive to heat, such as a person with poor blood circulation.

**DO NOT** use pins on chair. This may damage the electrical wiring.

**NEVER** seat if inner liner is wet.

Maintain labels and nameplates. These carry important information. If unreadable or missing, contact our customer service email [service@venustaofficial.com](mailto:service@venustaofficial.com)

Heating elements are not recommended to touch bare skin.

Shut off power immediately if discomfort occurs.

**DO NOT** dispose of used battery pack in household trash or by burning it.

**DO NOT** allow the cords to be pinched.

**DO NOT** store the battery pack together with metal objects (short circuit risk).

If improper operation of this chair is observed, discontinue its use immediately and contact our customer service email [service@venustaofficial.com](mailto:service@venustaofficial.com)

Use only our charger for changing Venustas battery packs. **DO NOT** use battery pack from other systems.

Store only in a dry room. Keep dry all the time.

**NEVER** break open battery packs and chargers.

## Customer Service - FAQ

### 1 Q: How long will the battery last while in use?

A: In normal temperatures (68 F /20 C) & used for chair with 2 heating panels, the battery will last about 11 hours at low heat level, 6-7 hours at medium, or 3-4 hours at high.

NOTE: The working hour of the battery will be greatly affected by the temperatures. The lower temperature will lead to shorter heating hours.

### 2 Q: How to troubleshoot when the heat chair doesn't work?

A: Step 1: Connect your cellphone with the battery to check whether it can charge up the cellphone.

Step 2: Reconnect the battery with the chair and make sure the power button on the chair will flash in red light and then goes off. If not, replug and try again.

Step 3: Press and hold the power button on the chair for 3s to check if the power button flashes in red light slowly.

If anything goes wrong with step 2 or step 3, please contact our support team for further troubleshooting.

### 3 Q: How do I take care of my battery?

A: To keep it at peak performance, you should fully charge the battery before you use it or store it. Charge it every 3 months after you store it.

### 4 Q: How to charge my cellphone with the battery?

A: Connect the cellphone and battery with the charging cable, then press the power button to activate the battery.

### 5 Q: Is there a warranty available? How long does it cover?

A: 1-Year warranty covering any defects or malfunctions of Venustas chair heating components and Venustas battery pack.

Warranty becomes valid from the date of purchase. Contact [service@venustasofficial.com](mailto:service@venustasofficial.com) for more info.