

# PARALLELING SWITCHGEAR

for Industrial Power Systems



**KOHLER**<sup>®</sup>  
IN POWER. SINCE 1920.



## TABLE OF CONTENTS

Total System Integration	5
The Benefits of Paralleled Power	6
The KOHLER Difference™	8
Typical Paralleling Applications	10
How Paralleling Works	12
Transition Types	16
Chart-Based Sequence of Operation	18
The Operator Interface	22
System Controls Architecture	26
Kohler® PD-Series™ Paralleling Switchgear	28
Decision-Maker® Paralleling System	30
Service and Support	32





Aurora  
Sheboygan  
Memorial  
Medical  
Center

KOHLER

KOHLER

We're nearly 100 and only getting better with age. For the last century, we've forged the future, redefining what power means to people's lives, careers and lifestyles.

**POWER IS W**

**192**

# WHY SINCE WHAT WE DO.

## **SO WHY KOHLER?**

**We're a company of fearless thinkers driven to empower people all over the world — with reliable, revolutionary engines, generators and power systems.**

**We exist for one reason:  
*TO MOVE YOU FORWARD.***

# YOUR JOB IS COMPLEX. WE MAKE IT EASY.



At Kohler there's no such thing as a standard, one-size-fits-all power system—each one is unique. We know that the best system is the one that's built to your project's specific requirements.

Your KOHLER® power system is customized and built by a dedicated team of Kohler engineers. **Total system integration** means that no matter how large or complex, everything works together seamlessly—from generators and transfer switches to paralleling switchgear and controllers.

Kohler has been a single-source supplier of complex power systems for decades. You know our generators. You know our transfer switches. Now get to know our paralleling switchgear.

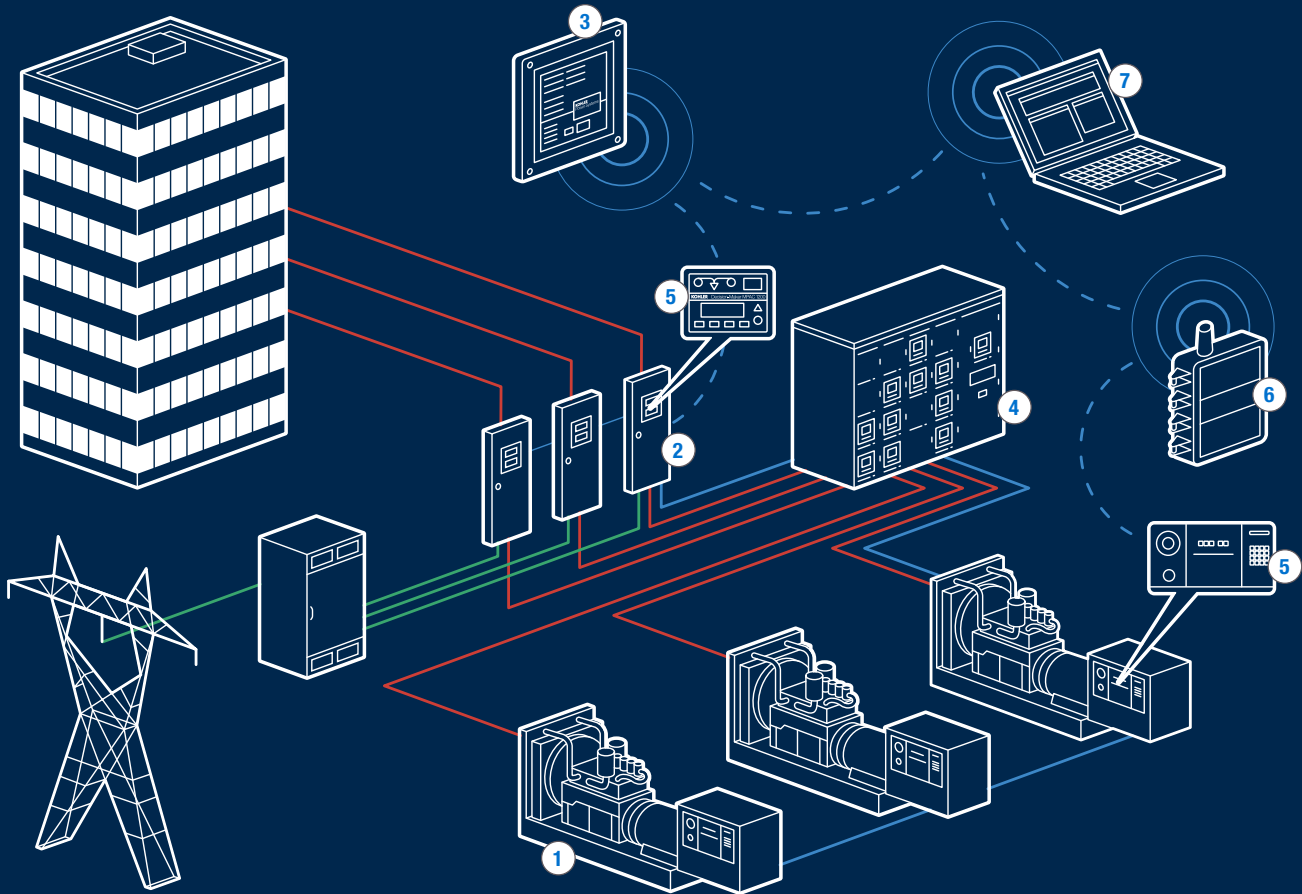

## Total System Integration

**1 KOHLER® GENERATOR**  
Gas generators 40–1300 kW  
Diesel generators 10–4000 kW

**2 KOHLER AUTOMATIC TRANSFER SWITCH**  
Open, closed and programmed transition operating modes; standard, bypass-isolation and service-entrance switch configurations

**3 KOHLER REMOTE ANNUNCIATOR**  
Remote monitoring and testing of transfer switches

**4 KOHLER PARALLELING SWITCHGEAR**  
Low and medium voltage

**5 KOHLER DECISION-MAKER® CONTROLLER**  
Controls, monitors and aids system diagnostics

**6 KOHLER WIRELESS MONITOR**  
Performance monitoring around-the-clock

**7 KOHLER MONITORING SOFTWARE**  
Monitors generators and transfer switches from a PC



# THE BENEFITS OF PARALLELED POWER

## Maximize Your System's Flexibility

While it may be common for a facility to install a single large generator to meet its power needs, paralleling two or more generators offers a number of practical benefits and advantages over a single-generator system.

### **REDUNDANCY**

The redundancy provided by the paralleling of two or more generators delivers greater reliability and flexibility than a single generator can provide. In critical applications, having more than one generator connected to the bus at all times ensures continuous generator power in the unlikely event that a generator fails.

### **EFFICIENCY**

Instead of one large generator that might operate at an inefficiently low kW, several small generators can be paralleled together and turned on and off as necessary to efficiently support the varying demands of the load.





## VALUE

In some cases, multiple small generators may cost less than one large generator.

## POWER REQUIREMENTS

If the largest available generator is too small to meet the power requirements, two or more generators can be paralleled to provide the necessary power.

## SPACE CONSTRAINTS

If space is limited and a large generator will not fit, multiple smaller generators can be utilized.

## FUTURE GROWTH

A paralleled system can be designed to add additional generators as your facility's load requirements expand.

# THE KOHLER DIFFERENCE

## Our Proven Process

Kohler carefully considers your requirements and develops a solution that meets your needs. Every design starts with our proven, time-tested process that builds your system to your exact requirements.

Our experienced engineering team helps you every step of the way, determining and specifying your requirements, designing the system and providing easy-to-read drawings and documentation. Kohler's rigorous testing and careful commissioning ensure that your paralleling switchgear is always ready to supply generator power when needed.

### **NO GUESSWORK**

Kohler's chart-based sequence of operation eliminates the guesswork by detailing each step of every sequence. It clearly describes how the system works, what happens if there is a failure and the actions an operator can take to maintain power.

### **INTUITIVE USER INTERFACE**

It's as simple as selecting the sequence you want, verifying your choice and pressing the start button. Watch the screen as the system moves step-by-step through the sequence.

### **FAULT-TOLERANT PROGRAMMING**

If a breaker fails to open or close and the system is unable to complete the sequence, the system will respond to the fault and seek a source of power to the load. This programming also allows for a transition from manual mode to automatic mode regardless of the state the system is in.

### **SEAMLESS SYSTEM INTEGRATION**

With Kohler's total system integration, every component—from generator and transfer switch to paralleling switchgear and controller—is designed, built and tested to work together seamlessly.



# Typical Paralleling Applications

## MATCH THE SYSTEM TO YOUR POWER NEEDS

Kohler provides the system and operating modes that meet the needs of your facility, whether you require simple standby power or multiple-utility paralleling and emergency power, prime power or peak shaving.

### EMERGENCY / STANDBY

The generators provide power in the event of a loss of utility service. Power transfer can take place at the transfer switch or by using the breakers in the switchgear. [Figure 1](#) shows a typical ATS-based emergency/standby power system. The generator power is combined onto the paralleling bus. Power flows through the feeder breakers in the paralleling switchgear to the emergency connection of the ATS.

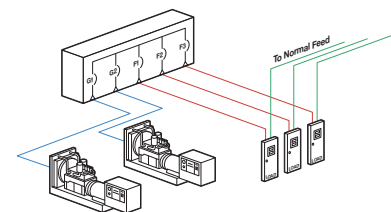

Figure 1

### SINGLE-UTILITY SYSTEM

[Figure 2](#) shows a typical single-utility system in which the entire facility is placed on generator power. During a power outage, the utility main breaker opens; after a user-selected number of generators are online, the generator main breaker closes. The return to utility power can be open, closed or soft. Because the generator main breaker separates the load bus from the generator bus, the generators can be paralleled in test mode without affecting the load.

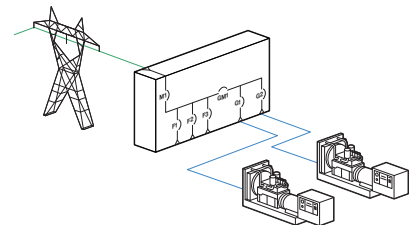

Figure 2

### DUAL-UTILITY SYSTEM—LINEAR

[Figure 3](#) shows a typical dual-utility system. This can be one lineup or a separate “A” and “B” lineup connected by tie breakers. If there is a loss of only one of the utility feeds, the system can be programmed to place that side on generator power, transfer all the loads to the remaining good utility or transfer the entire system to generator power. When the utility returns, the transfer back to utility can be open, closed or soft. If the system is on generator power because both utilities fail and only one utility returns, the system can be programmed to return that side to utility power, return all loads to the one good utility or wait until both utilities return before automatically returning to utility power.

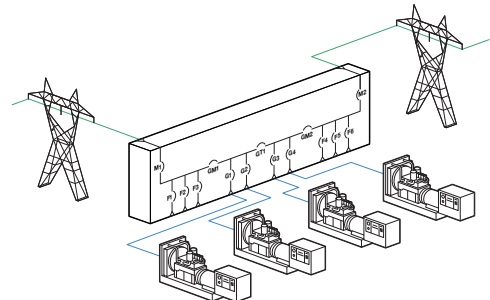

Figure 3

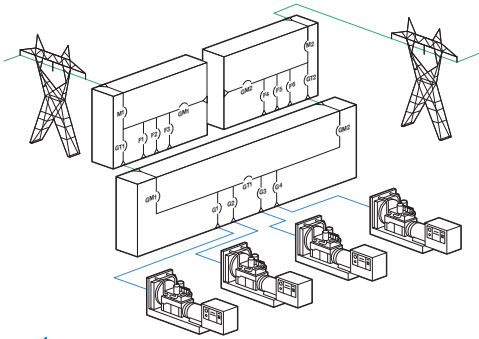

Figure 4

## DUAL-UTILITY SYSTEM—RING

Figure 4 shows a typical dual-utility system in which the utility bus and generator bus are separate lineups. The available sequence of operations is similar to the linear dual-utility system.

The advantage of the ring dual-utility configuration over the linear configuration are:

- The ability to feed the entire system with one utility feed without energizing the generator paralleling bus.
- The ability to automatically respond to the generator's main breakers failing to close and provide an alternate path to feed generator power to the load.

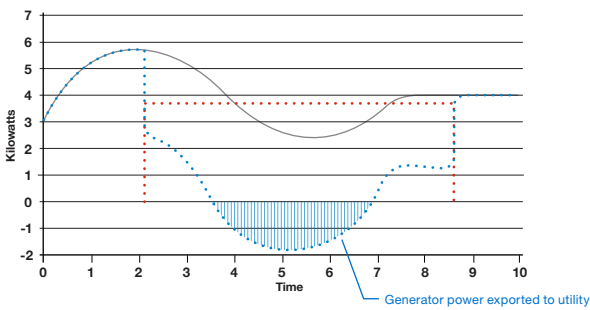

Figure 5

## PEAK SHAVE

Peak shaving reduces your facility's electrical power consumption during periods of high demand on the power utility. A peak shave system can remain paralleled to the utility or remove your facility's loads from the utility and place them on generator power.

### Base Load Mode

The generators remain paralleled to the utility, producing power at a preset base load level. If the facility's load is less than the base load setpoint, the extra power is exported to the utility. As shown in Figure 5, the shaded area is generator power exported to utility.

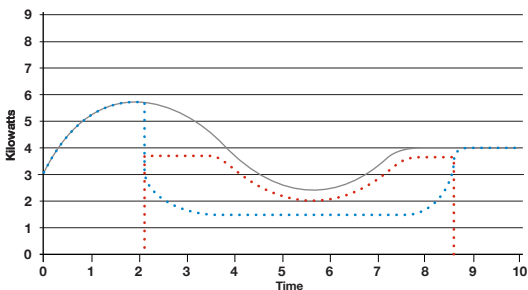

Figure 6

### Import Mode

The generators remain paralleled to the utility, producing power and maintaining a preset kW level flowing in from the utility. Generator output varies to support the load and maintain the fixed amount of power from the utility. If the load is high, the maximum generator output is limited to the base load kW setpoint. Figure 6 shows the generator output ranging with load to maintain constant power from the utility.

### Interruptible Mode

The generators are paralleled to the utility, the facility load is transferred from the utility to the generators, and the main breaker opens, separating the facility from the utility.

#### KEY

●●●● Generator    — Plant Load    ●●●● Utility

# How Paralleling Works

## IT'S ALL ABOUT THE CONTROLS

Let's look at a typical response to loss of utility power. When a loss of utility power occurs, almost every system responds with the basic sequence shown here.

### 1 / ENGINE START DELAY

A timer starts when there is a loss of utility. If utility returns before the timer expires, the system does not start. If the utility outage is long enough for the timer to expire, the system will commit to transferring to generator power.

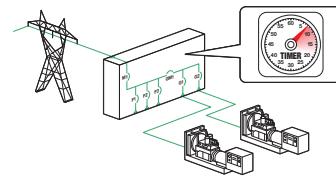

### 2 / START / START-UP LOAD SHED

All available generators start. If the system is designed to supply power to loads as soon as one generator is online (typical for systems serving critical and life-safety loads), low-priority loads are shed or are inhibited from transferring. This prevents the first-on generator from being overloaded.

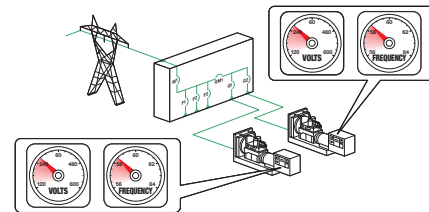

### 3 / FIRST GENERATOR BREAKER CLOSES

The first generator to reach the rated voltage and frequency closes to the bus. First-on logic prevents multiple generators from simultaneously closing to the bus. The bus is now energized, and power is available to the load. Low-priority loads remain shed with F2 and F3 still open.

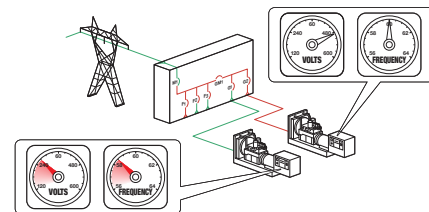

### 4 / SYNCHRONIZATION

The incoming generator's voltage, frequency and phase are matched to the running bus. When matched, the generator paralleling breaker closes.

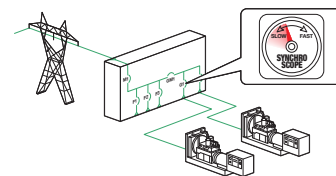

## 5 / SECOND GENERATOR BREAKER CLOSES/LOAD SHARING

Additional generator power is available to the load. The system's load-sharing controls actively control the kW and kVAr output of each generator in order to proportionally share the load (maintain the same percent load on each generator) and maintain rated frequency and voltage.

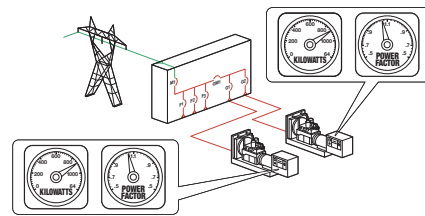

## 6 / LOAD MANAGEMENT

As additional generators close to the bus, more power is available for the load. The load management of the system actively adds loads based on bus capacity available.

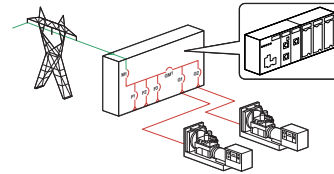

## 7 / GENERATOR MANAGEMENT

Generator management optimizes the number of online generators based on the load's kW demand, starting and stopping as required. Generators are sequenced on in order of operator-assigned priority (or based on runtime) and taken off in reverse priority. Operator-defined setpoints determine the percent load level and time delay at which the genset will be brought on or taken offline.

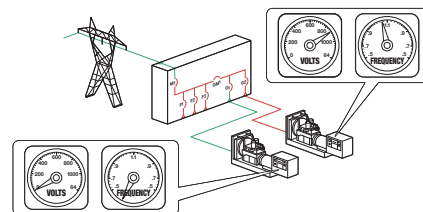

# How Paralleling Works

## IT'S ALL ABOUT THE CONTROLS: SYNCHRONIZATION AND LOAD MANAGEMENT

### SYNCHRONIZATION

Let's take a detailed look at the synchronization process. The automatic synchronizer matches the incoming generator's output (waveform) to the running bus. When the voltage, frequency and phase are all matched, the synchronizer will close the incoming generator's breaker.

#### VOLTAGE MATCH

The synchronizer adjusts the incoming generator's **voltage** to match the running bus.

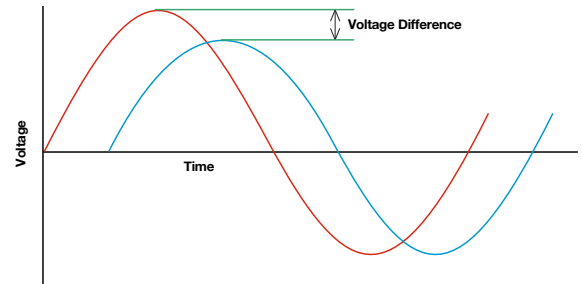
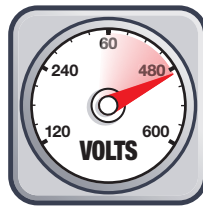

#### FREQUENCY MATCH

The synchronizer adjusts the incoming generator's **speed** to match the frequency of the running bus.

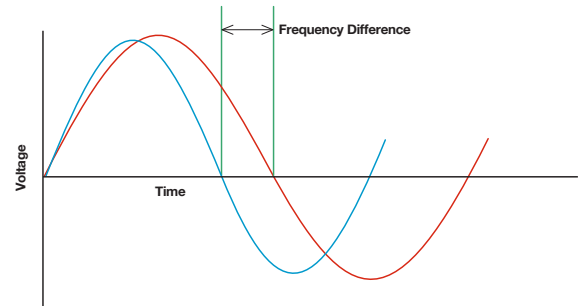
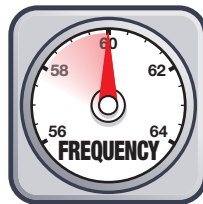

#### PHASE MATCH

The synchronizer adjusts the incoming generator's **speed** to match the phase of the running bus. When matched, the two sine waves will be the same.

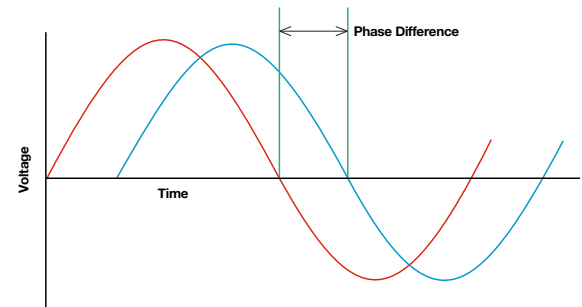



## LOAD MANAGEMENT

Each load is assigned a priority level. Load management determines when priority levels are signaled to disconnect (shed) and reconnect (add). When multiple generators are online, load management matches the load to the generator capacity. The system can control feeder breakers or transfer switches. Dry contacts or communications can be provided to interface with your building-management system.

In a paralleled generator system, it is imperative to plan for the unlikely event of a generator failure. Removing or shedding load prevents the remaining online generators from overloading and tripping offline.

### LOAD ADD

Loads can be added based on several considerations including:

- **Generator bus capacity:** loads are added based on the kW capacity of the bus and an assumed kW demand of the load.
- **Number of generators online:** loads are added based on how many generators are connected to the bus; this is most effective in systems with same-size generators.

### LOAD SHED

A load-shed event can be triggered by multiple parameters including:

- **Generator failure:** loads are shed based on the number of failed gensets.
- **Kw overload:** When the generators reach their overload setpoints, low-priority loads sequentially shed until the load falls below the overload setpoint.
- **Underfrequency:** underfrequency is often an indication that the generators are fully loaded and cannot supply additional power to the load. When the bus frequency reaches its underfrequency setpoint, preset loads are shed.

# TRANSITION TYPES

## Customized to Your Needs

KOHLER® paralleling switchgear can be configured with the transition type you need. From a basic open to a soft (ramp) transfer, Kohler will customize your system to meet your requirements.

### CLOSED TRANSFER

In a closed transfer, the source from which the load is being transferred and the source to which the load will be transferred are connected together momentarily. After both sources are closed, the source from which power is being transferred is opened. If the system is configured for fast transfer, the source from which the power is being transferred will open within 100 ms. If the system is configured for soft (ramp) transfer, the load will be transferred at a user-adjustable kW/sec rate until the source from which the power is being transferred reaches an unloaded setpoint. The load remains energized during the transfer from one source to the other.

### EXAMPLE

Closed transfer from generator power to utility power after a power outage.

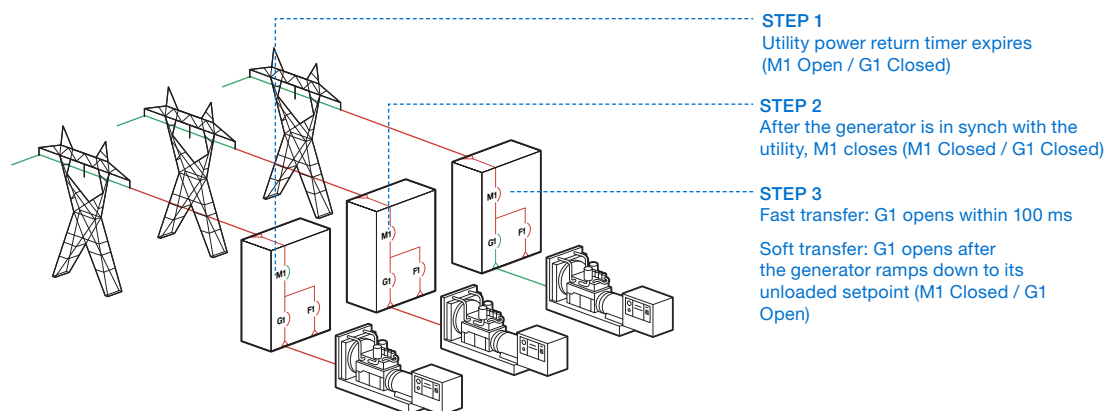



## OPEN TRANSFER

The load is disconnected from one source before being connected to the other source. The load is without power for the duration of the open-transfer time delay.

### EXAMPLE

Open transfer from generator power to utility power after a power outage.

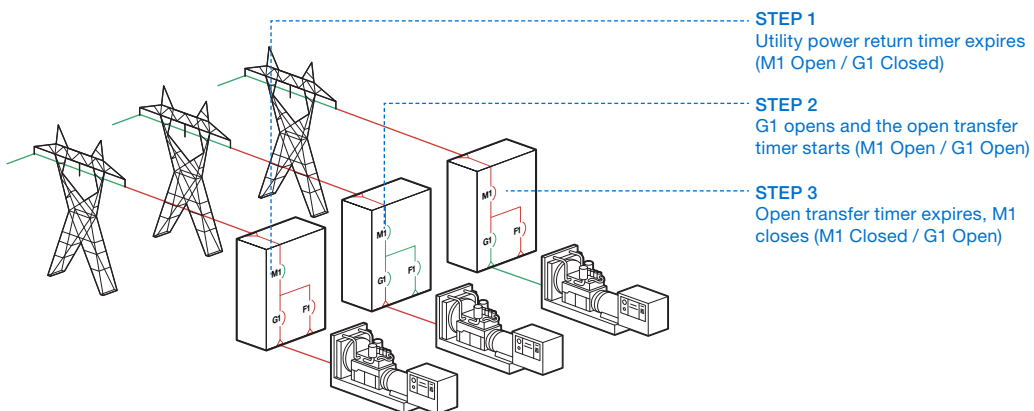

# CHART-BASED SEQUENCE OF OPERATION

## Step-By-Step System Response

Kohler's unique approach to our sequence of operation differs from the typical narrative-based sequence. Ours is a customized checklist that eliminates the guesswork and ambiguity from knowing how your system will respond to both normal operations and in the unlikely event of a system failure.

- Intuitive chart is easier to read than a typical flowchart.
- Clearly shows system response, timing of response and what the system and operator can do if the system fails to respond properly.
- Provides a checklist for testing and commissioning your paralleling switchgear.

Each sequence has two charts: the **SEQUENCE** and the **RESPONSE TO ABNORMAL CONDITIONS**.

### SEQUENCE CHART

This lists the steps the system takes from initial state to final state.

- The initial state shows the status of each breaker in the transfer sequence and the power status of each bus in the system.
- The first step is the triggering event that starts the sequence. This could be the receipt of a remote start signal, the utility out of tolerance or an operator pushing a button.
- Next is a description of the steps required to get to the final desired state, along with the corresponding system response.
- Finally, the final state for each breaker is described, along with the power status of each bus in the system.

The sequence chart also has a cross-reference to the response to abnormal conditions chart in the "If-fail" column. Generally, for each response that involves a breaker opening or closing or a timer starting, an "if fail" predetermines how the system will respond if a breaker fails to open, a breaker fails to close or something happens to prevent a timer from timing out. Other responses that require an "if fail" are a generator failing to start, a generator failing while running or a generator becoming overloaded.

## SEQUENCE CHART (EXAMPLE)

1 INITIAL STATE	UA	Bus A	GMA	Gen Bus	GMB	Bus B	UB	2	
	X	E	O	D	O	E	X	3	
4 STEP	EVENT	5	RESPONSE			6	IF FAIL		7
1	Utility A and utility B are out of tolerance.		Utility A failure timer starts.					A	
			Utility B failure timer starts.					B	
2	Both utility failure timers expire or one timer expired while the other is still timing.		Utility breaker UA opens.					C	
			Utility breaker UB opens.					D	
			All available generators start.						
			Required GOL bypass timer starts.						
3	Utility breaker UA is open.		Bus A open transfer timer starts.						
			<b>Startup Shed Option:</b> Based on the load-management settings, loads on bus A are shed.						
4	Utility breaker UB is open.		Bus B open transfer timer starts.						
			<b>Startup Shed Option:</b> Based on the Load-Management settings, loads on bus B are shed.						
5	The first generator reaches rated voltage and frequency.		The first generator breaker closes.						
6	The remaining generators independently reach rated voltage and frequency.		The remaining generators independently synchronize to the bus and close their respective circuit breakers.					E, F	
7	Required generators are online and the bus A open transfer timer expired.		Generator main breaker GMA closes.					G	
8	Generator main breaker GMA is closed.		Bus A is on generator power.						
			Required GOL bypass timer stops.						
			Generator stabilization timer starts.						
9	Generator stabilization timer expires and bus B open transfer timer expired.		Generator main breaker GMB closes.					H	
10	Generator main breaker GMB is closed.		Bus B is on generator power.						
11	Bus A and B are on generator power.		<b>Startup Shed Option:</b> Based on the load-management settings, loads are added to the bus A and B.					I	
			<b>Generator Management Option:</b> Becomes active if in auto and all loads have been added.						
8 FINAL STATE	UA	Bus A	GMA	Gen Bus	GMB	Bus B	UB	9	
	O	E	X	E	X	E	O	10	

- 1 The initial state shows current status of utility, generator main and tie breakers and availability of utility and generator power.
- 2 Breaker name and power source name.
- 3 Breaker open/close status and power source energized/de-energized status.  
X = Closed    E = Energized  
O = Open    D = De-energized
- 4 Step index.
- 5 System event is the input to system that will cause system to react, such as timer expiring or breaker opening or closing.
- 6 System response to event describes how the paralleling switchgear will automatically respond to event. If there are multiple responses to an event, each response is shown on a separate line.
- 7 If fail is a cross-reference to “response to abnormal conditions” chart that describes how system will react if system’s response to an event is not as listed in sequence chart (such as a breaker failing to close or failing to open).
- 8 Final state shows desired status of utility, generator and tie breakers and availability of utility and generator power after sequence has completed.
- 9 Breaker name and power source name.
- 10 Breaker open/close status and power source energized/de-energized status.

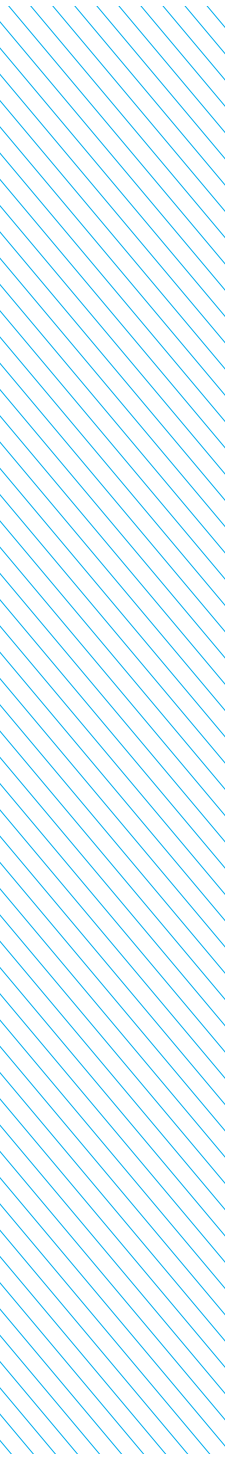

# CHART-BASED SEQUENCE OF OPERATION

## Response to Abnormal Conditions

This chart describes the system response and the action an operator can take if the system does not respond correctly to an event. It always follows the sequence chart.

- 1 Step fail is a cross-reference from sequence chart to indicate which step in the system's response to an event is not per sequence.
- 2 Event column describes what went wrong, such as a breaker failing to open or close.
- 3 System response column describes how system will automatically respond to failure. Depending on system inputs such as availability of utility power, there may be different system responses. Each is listed.
- 4 Operator action column describes physical actions operator can take in order to reset fault and/or manually intervene and complete sequence of operation. Depending on inputs to system such as availability of utility power, there may be different actions operator can take. Each is listed.

## RESPONSE TO ABNORMAL CONDITIONS CHART (EXAMPLE)

1 STEP FAIL	2 EVENT	3 SYSTEM RESPONSE	4 OPERATOR ACTION
A	Utility A power returns before Utility A failure timer expires.	Bus A remains on utility A.	No operator action required.
B	Utility B power returns before Utility B failure timer expires.	Bus B remains on utility B.	No operator action required.
C	Utility breaker UA fails to open.	Utility A remains failed, Utility B remains failed: Bus A is without power. Generator main breaker GMA does not close. After the required generators are online, generator main breaker GMB closes.	<p>Option #1: Reset the Fail to Open alarm. System attempts to open utility breaker UA. When breaker opens, transfer automatically continues.</p> <hr/> <p>Option #2: Manually open utility breaker UA. Transfer automatically continues if system is in Auto.</p> <hr/> <p>Option #3: 1. Place system in Manual. 2. Manually open utility breaker UA. 3. If required, shed load. 4. Manually close generator main breaker GMA.</p>
		Utility A remains failed, Utility B returns: Bus A is without power. The system transfers bus B from generator power to utility B power following the expiration of the Utility B stable timer.	No operator action required.
		Utility A returns, Utility B remains failed: Bus A remains on utility A. Bus B remains on generator power.	Operator may manually transfer bus B from generator power to utility A power.
		Utility A and Utility B return: Bus A remains on utility A. The system transfers bus B from generator power to utility B power following the expiration of the Utility B stable timer.	No operator action required.
		Utility B remains failed, Utility A remains failed: Bus B is without power. Generator main breaker GMB does not close.	Option #1: Reset the Fail to Open alarm. System attempts to open utility breaker UB. When breaker opens, transfer automatically continues.
D	Utility breaker UB fails to open.	Utility B remains failed, Utility A remains failed: Bus B is without power. Generator main breaker GMB does not close.	Option #1: Reset the Fail to Open alarm. System attempts to open utility breaker UB. When breaker opens, transfer automatically continues.

# THE OPERATOR INTERFACE

## System Control at Your Fingertips

The operator interface or touchscreen both monitors and controls the system and is customized to your project.

It is specifically designed to be user-friendly and eliminate guesswork, letting the operator focus on the task at hand instead of wondering how to navigate through the screens.

Whether the user is advanced or a first-time operator of the system, the KOHLER® paralleling switchgear interface provides the information in a simple but comprehensive way.

### **INTUITIVE OPERATION**

With basic knowledge of paralleling switchgear, the operator can navigate the system simply and intuitively without reading a manual. The intuitive interface eliminates fear of operational errors by clearly showing “if this, then that” before a sequence is initiated.

### **THE RIGHT INFORMATION AT THE RIGHT TIME**

By providing pertinent information on each screen, the operator always knows the reaction to an action.



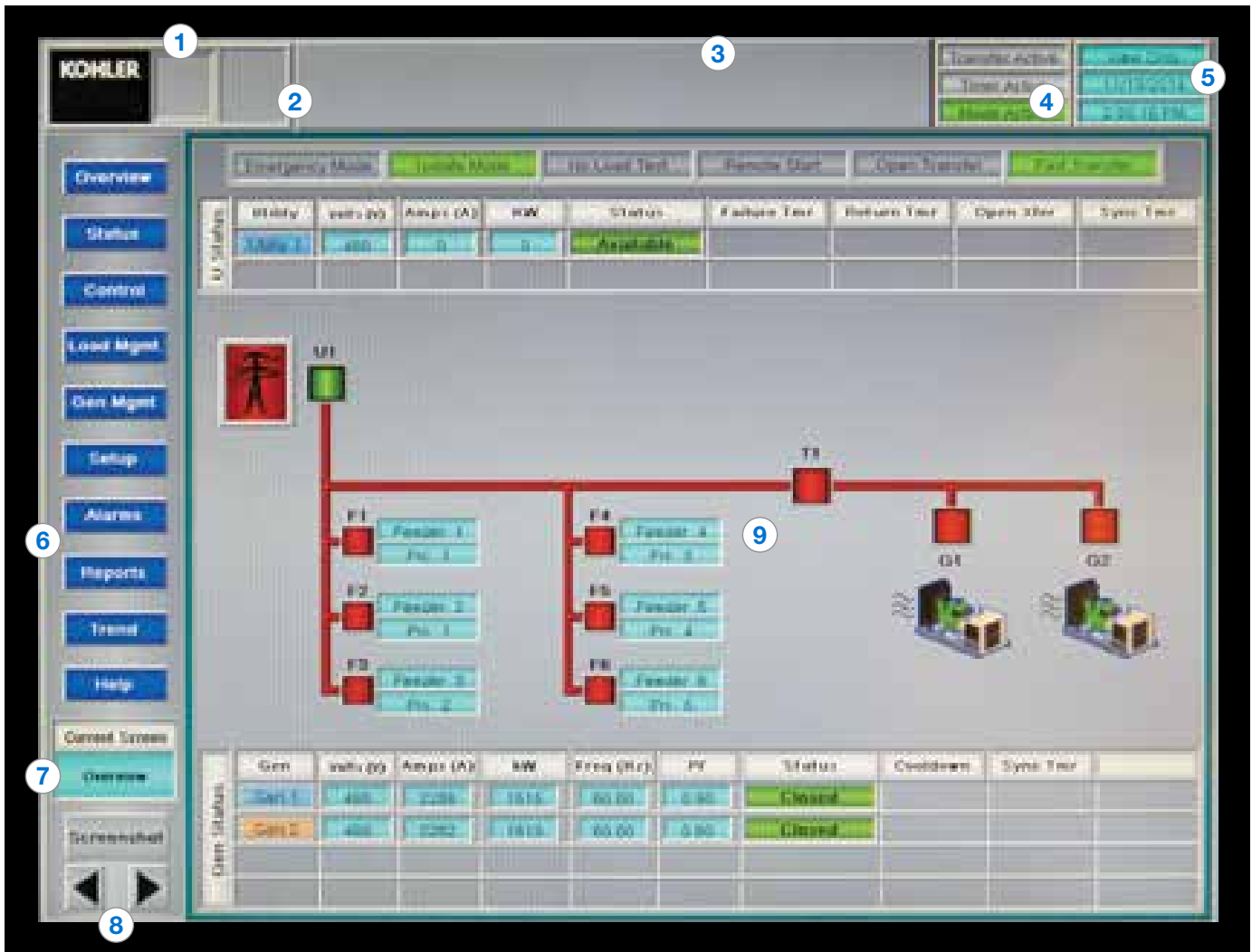

**1 Not in auto indication**

Flashes if any control switch is not in auto mode. Touch to see all switches/controls that are not in auto.

**2 Alarm or warning indication**

Flashes to indicate an unacknowledged alarm or warning. Touch to go to the alarm list.

**3 Active alarm and warning**

Displays the five most recent items on the alarm list.

**4 System status indication**

Annunciator lights up to indicate if any transfer is active, timer is active or any mode is active.

**5 Login indication**

Shows current login information, date and time.

**6 Main menu**

Touch to select submenu.

**7 Current screen**

Displays current screen name. Use push button to capture screenshot of current screen.

**8 Navigation buttons**

Touch to go forward or backward through screens.

**9 Display area**

Shows screens.

# THE OPERATOR INTERFACE

## Examples of Control and Setup

### EXAMPLE OF CONTROL

#### Generator Screen

- Used to monitor and manually control the generator.
- Contains typical controls such as the generator AUTO/OFF/RUN ONLINE/RUN OFFLINE switches and generator synchronizer control switch.
- Shows generator status and metering information.



#### Transfer to Utility Screen

- Used to monitor and manually initiate the transfer from generator power to utility power.
- Top half of screen shows power source metering and an active single-line diagram.
- Lower half of screen contains the controls and displays current status of the sequence embedded in an active flowchart of the sequence of operation.



## EXAMPLE OF SETUP



### System Status

- An example of the user configuration and setup screens available.
- Allows the user to define parameters and timers used to determine a loss of utility power and set other time delays in the system.



### Generator Management

- Used to monitor and configure generator management mode.
- User sets all parameters associated with generator management and can enable or disable this mode of operation.
- Right side of screen graphically displays settings and current state of the system.

# SYSTEM CONTROLS ARCHITECTURE

## Customize It Just the Way You Want It

Controls architecture redundancy is a delicate balance between risk, cost and complexity. With a KOHLER® system, you choose the level of redundancy you are comfortable with that works with your budget. Whether it's manual backup or a redundant automation system, Kohler has a solution that's right for you.

### MANUAL BACKUP

#### Standard

As a standard, every KOHLER system is designed to be fully functional in the unlikely event of a touchscreen failure. If the touchscreen fails, the operator, using hardwired switches, can start the generators and place them online.

#### Option 1

This option contains all the features of the standard system and provides the ability to synchronize and parallel (load share) generators if the touchscreen and/or the PLC fail.

#### Option 2

This option contains all the features of Option 1 and provides the ability to manually synchronize generators using hardwired speed and voltage adjustment switches and to synchronize and parallel (load share) generators if the touchscreen and/or the PLC fail.



## REDUNDANT AUTOMATION SYSTEMS

### Standard Automation Controller Architecture

The standard architecture consists of a master automation controller for system control (load add/shed, generator management, control of main, tie or feeder breakers) and an automation controller for each generator, along with a dedicated communication connection between the generator automation controller and its associated generator. Redundant communications between automation controllers are available as an option.

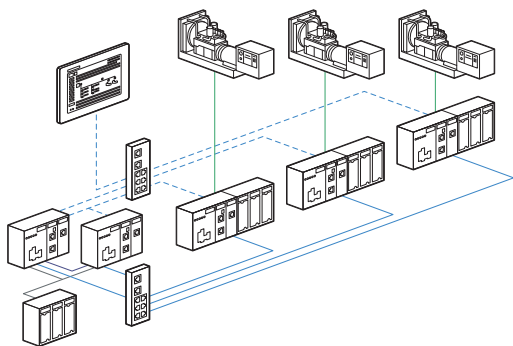
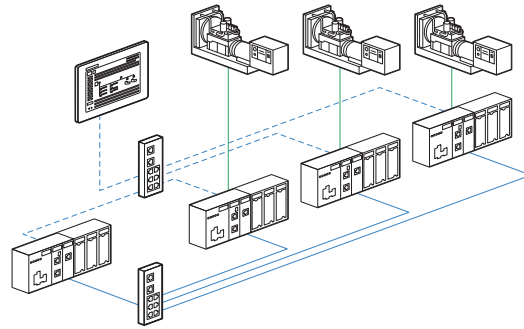

### Optional Hot Standby Master Automation Controller

The hot standby master consists of primary and secondary CPU racks. Each rack has its own power supply, communication and CPU. If the primary CPU fails or is taken offline, control transfers smoothly to the secondary automation controller.

### Optional Rotating Master Automation Controller

For systems where master control functionality is limited, an optional rotating master system is available. In this arrangement, there is no master automation controller; the master logic is contained in each generator's automation controller. A generator automation controller is designated the master logic and controls the master I/O. If that automation controller should fail or go offline, execution of the master logic and control of the master I/O is transferred to another available generator automation controller.

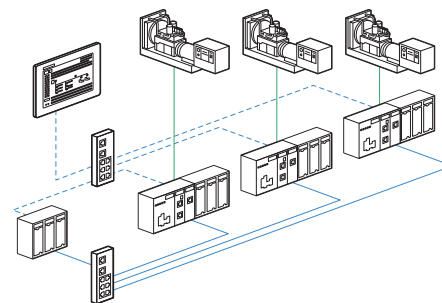

# KOHLER® PD-SERIES™ PARALLELING SWITCHGEAR

## Reliable Solutions for Every System

Any mode of operation—emergency standby, prime power, base load/peak shave, import/peak shave, interruptible rate and customized sequence of operation—can be used with any of our PD-Series switchgear.



### PD-2000 SERIES™

The PD-2000 Series is UL 891-listed and allows extreme flexibility in design while providing a strong standard for safety and performance.

- Rear access standard, front access available
- Shallow depth (36-42 in.) available
- UL 489 fixed or drawout breakers for generator sets, utility and distribution
- Molded-case breakers available for distribution
- Bus ratings through 10,000 amps/150 kA withstand
- Complete selection of breaker trip options
- Complete selection of power monitoring options
- NEMA 1, NEMA 3R available



### PD-3000 SERIES™

Offering the highest standard in bus withstand and breaker ratings, the PD-3000 Series is UL 1558-listed. The series is designed with reliability and serviceability in mind.

- Drawout breakers standard
- UL 1066 drawout breakers for generator sets, utility and distribution
- Complies with ANSI C37.20.1
- Bus ratings through 9200 amps/200 kA withstand
- Complete selection of breaker trip options
- Complete selection of power monitoring options
- NEMA 1, NEMA 3R available



## PD-4000 SERIES™

Available through 15 kV, the PD-4000 Series provides a complete solution by utilizing the strength of the digital control system combined with utility-grade protective relays.

- UL MV switchgear listing through 15 kV
- Complies with ANSI metal-clad switchgear requirements
- Bus and breaker ratings through 3000 amps
- Complete selection of protective relay options, power monitoring, neutral grounding resistors and control battery systems
- NEMA 1, NEMA 3R shelter aisle available

## PD-SERIES™ FEATURES

	PD-2000	PD-3000	PD-4000
Low-voltage switchboard (UL/cUL 891)	•		
Low-voltage switchgear (UL/cUL 1558)		•	
Medium-voltage metal-clad switchgear (UL/cUL-listed)			•
NEMA 1	•	•	•
NEMA 3R	•	•	•
Short-circuit rating up to 200 kA		•	•
Short-circuit rating up to 150 kA	•		
Bus rating up to 10,000 A	•		
Bus rating up to 9200 A		•	
Bus rating up to 3000 A			•
Maximum voltage 600 V	•	•	
Maximum voltage 15 kV			•
60 Hz	•	•	•
50 Hz	•	•	•
Parallel up to 32 generators	•	•	•
15" color touch screen (optional touch screen sizes available)	•	•	•
Customizable controls, relays and metering	•	•	•

# DECISION-MAKER® PARALLELING SYSTEM

## Total Integration From Top to Bottom

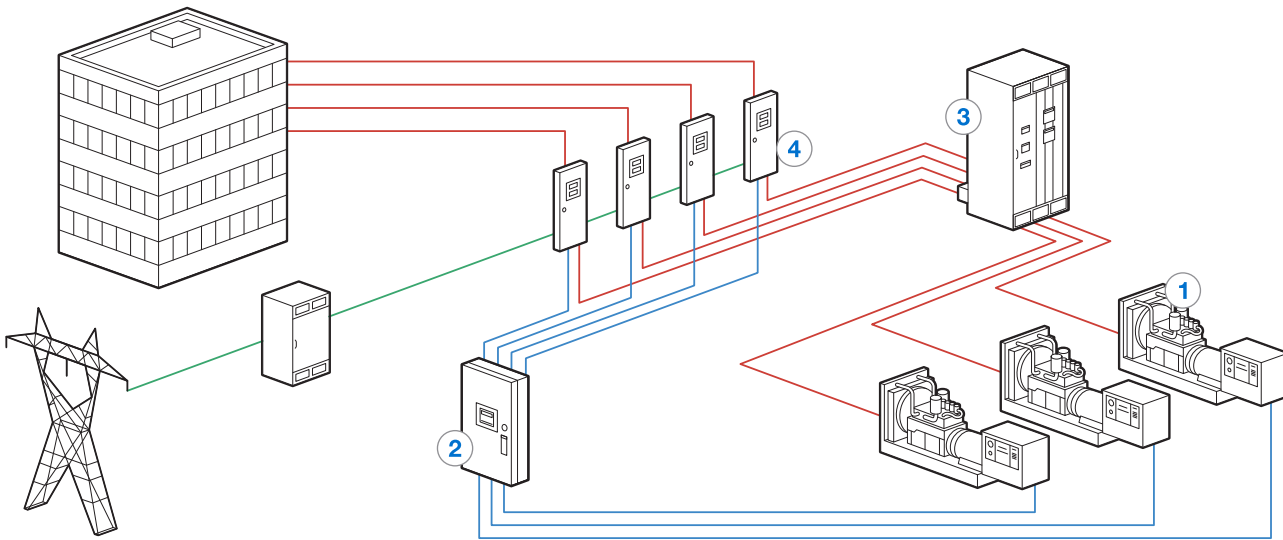

While KOHLER® PD-Series™ paralleling switchgear is custom-engineered to meet unique system demands, many paralleling applications are simple enough to utilize the KOHLER Decision-Maker Paralleling System (DPS). Applications suited to a DPS include emergency standby generators with limited load-shed requirements or systems where power transfer takes place in the ATS. The DPS is highly configurable on-site and offered with a fast lead time.

- 1 Kohler Decision-Maker 6000 Controller**  
Enables load sharing and synchronization for up to eight generator sets in the KOHLER DPS
- 2 Master Control Panel**  
Handles load add/shed, number of gensets online, monitors event logging and alarms
- 3 Power Distribution Switchboard**  
Accommodates paralleling and distribution breakers
- 4 Automatic Transfer Switch**  
Intelligently selects the power source and transfers loads



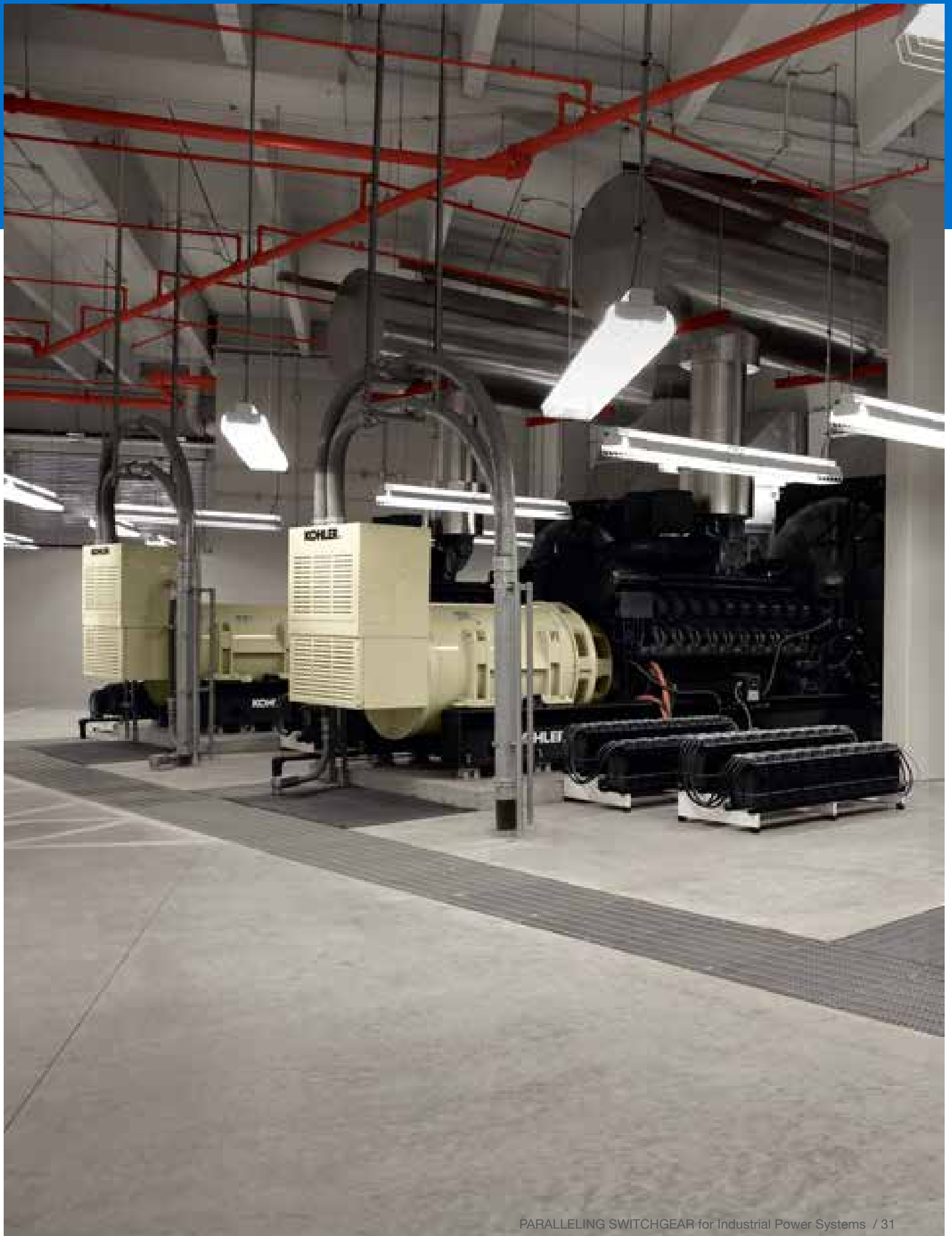



# SERVICE AND SUPPORT

**The help you need.  
Any time, anywhere.**

You're never too far from Kohler. Across the world, more than 800 locations are ready to provide sales, installation and aftermarket support services. And each one offers expertise in power specifications, equipment and integration. There's no question they can't answer. We should know, we trained them ourselves.

Plus, if you ever need assistance in the middle of the night, we'll take care of you. Kohler power professionals are available to offer troubleshooting, advice, service and support.

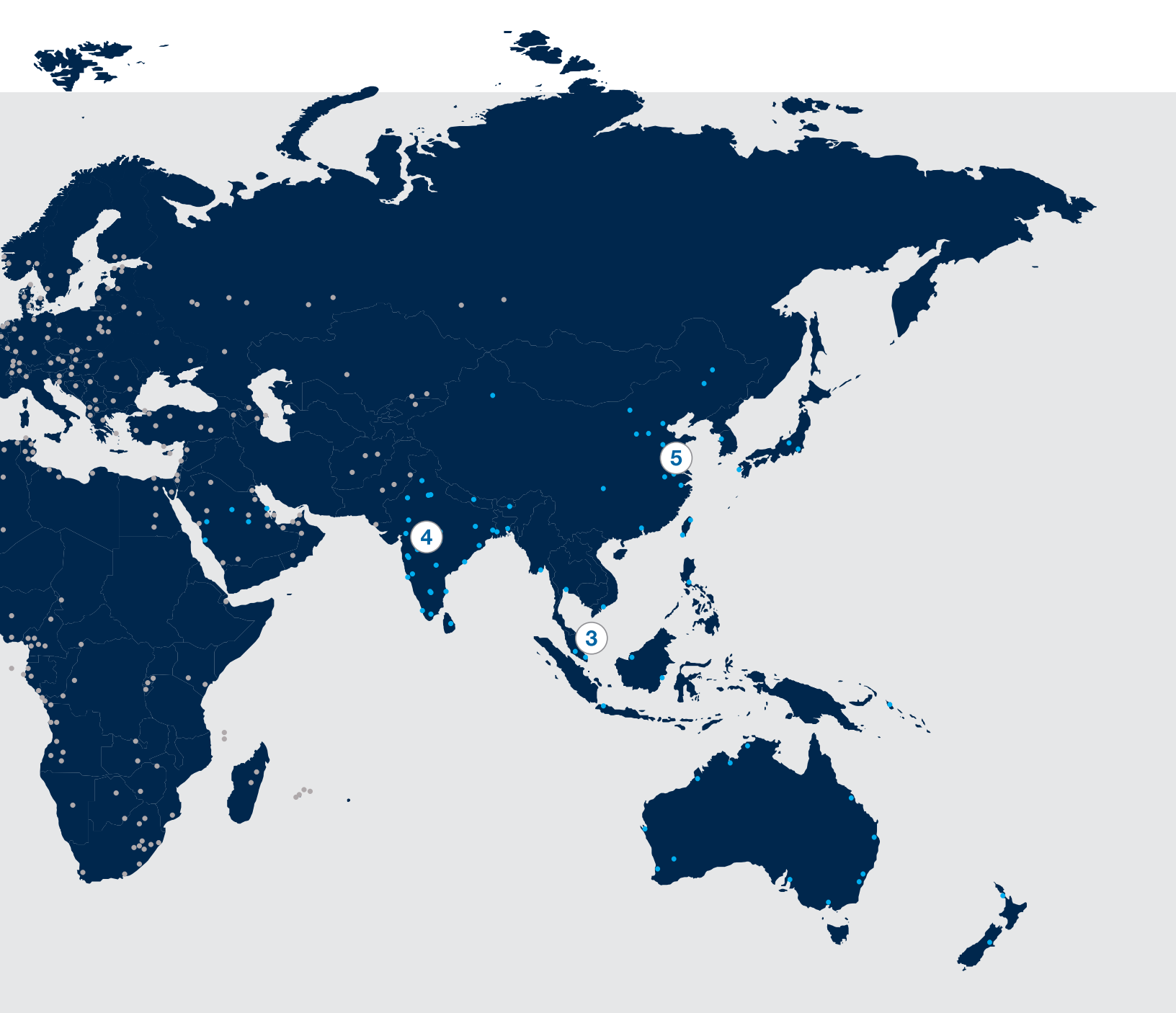

## KOHLER

- ① Headquarters and Manufacturing – Kohler, Wisconsin
- ② Headquarters EMEA
- ③ Headquarters Asia Pacific and Manufacturing – Singapore
- ④ Manufacturing Facility – India
- ⑤ Manufacturing Facility – China
- Sales Offices, Dealers and Distributors

## SDMO (KOHLER-OWNED)

- ⑥ Headquarters and Three Manufacturing Facilities – France
- ⑦ Manufacturing Facility – Brazil
- Sales Offices, Dealers and Distributors

**KOHLER**<sup>®</sup>  
IN POWER. SINCE 1920.

North America 800.544.2444

Learn more at [KOHLERPOWER.COM](http://KOHLERPOWER.COM)

PRINTED IN U.S.A. G12-455 02/17 © 2017 BY KOHLER CO.