

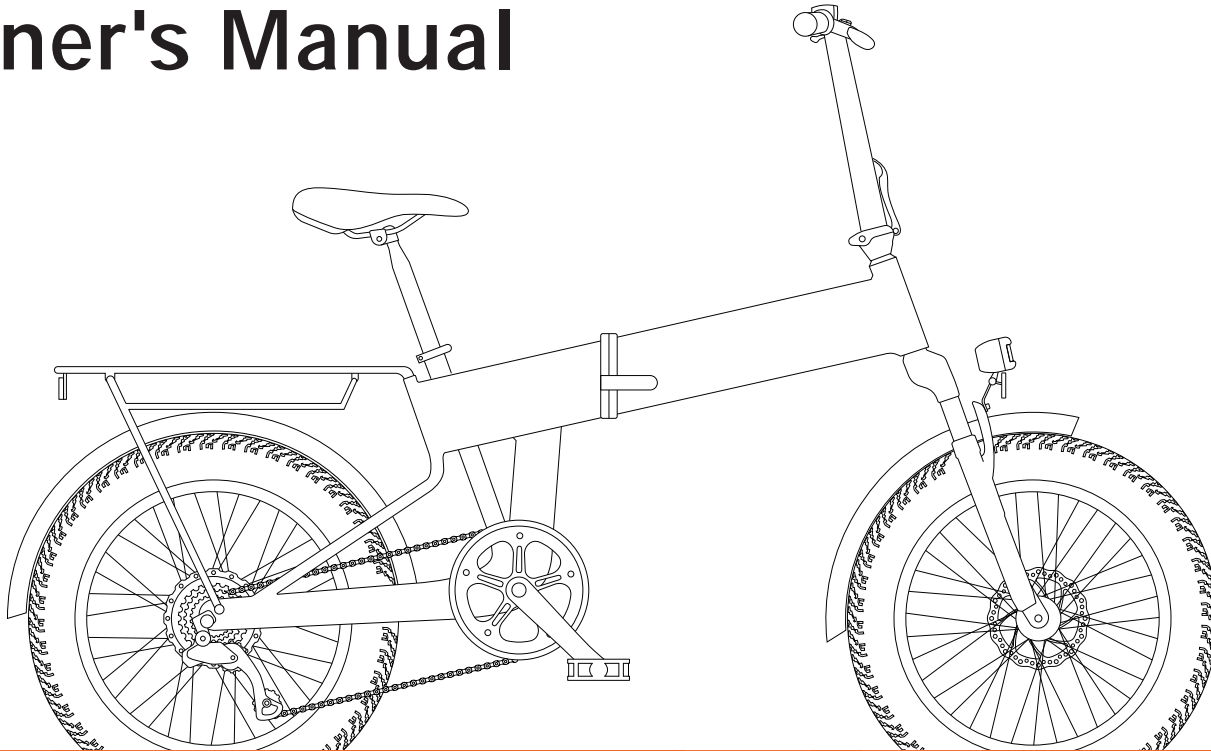

K1 — Best Choice For Your First E-bike

Owner's Manual



<https://kbobike.com>

Take down your serial numbers !

Go to page [7](#) to find your serial numbers

Bike Frame Number

Battery Serial Number

Motor Serial Number

Content

Important Safety Notice	2
Bike Specification	3
Bike Assembly Guide	5
How to Fold Your E-bike	8
Basic Display Settings	9
Safety Checklist	12
Battery Charging	13
Riding Modes	16
Storage and Transport Instructions	17
Carrying Loads & Cargo	18
Maintenance	19

About Manual

This manual contains details of the product, information on its operation and maintenance, and other helpful tips for owners. Read it carefully and familiarize yourself with the KBO Bike before using it to ensure safe use, reduce risk of damage and premature wear, and prevent accidents. Be sure to retain this manual as your convenient KBO Bike information source.

This manual contains many Warnings and Cautions concerning safe operation, and consequences if proper setup, operation and maintenance guidelines are not followed. All information in this manual should be carefully reviewed.

CAUTION The safety grade color of "CAUTION" is orange, and if not avoided, may result in moderate or serious injury.

WARNING The safety grade color of "WARNING" is red, and if not avoided will likely result in serious injury or death.

NOTICE Users should also pay special attention to information marked in this manual beginning with "NOTICE"

Please be aware that cycling carries inherent risks and this manual can't cover all possible scenarios. Responsibility for safe bicycle use lies with you, the rider. Keep this manual for reference; its contents are subject to change and the latest version can be found at kbobike.com. For safety and bike performance, have a trained mechanic assemble and adjust your KBO Bike.

*Riders should be at least 16 years old and under 70 to ensure safety on our e-bikes. If you can't sit comfortably on the e-bike, please refrain from riding it.

Important Safety Notice

WARNING - When using this product, basic precautions should always be followed, including the following:

- a) Review all instructions prior to using the e-bike.
- b) Keep a watchful eye on the e-bike when children are nearby to prevent injury.
- c) Avoid placing fingers or hands in any part of the e-bike
- d) Inspect the power cord and output cable regularly; do not operate the e-bike if you notice any damage, such as frayed wires or exposed insulation.
- e) For all equipment, the instructions shall indicate "This equipment is not intended to be used at ambient temperatures less than **45°C (113°F)** or above ambient temperatures of **-10°C (14°F)**."
- f) For all equipment, the instructions shall indicate "The battery is intended to be charged when the ambient temperature is between **0°C (32°F)** and **40 °C (104°F)**. Never charge the battery when ambient temperatures are outside this range."

Bike Specification

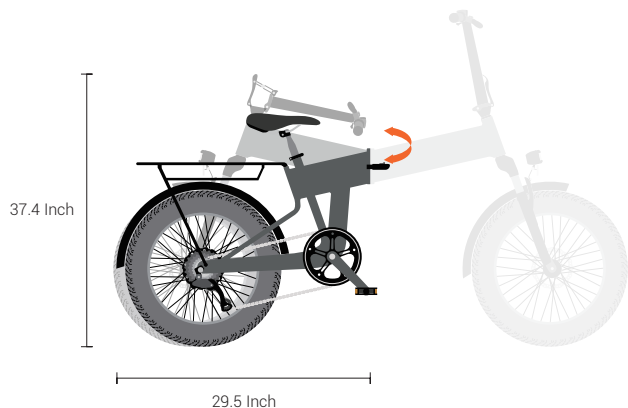
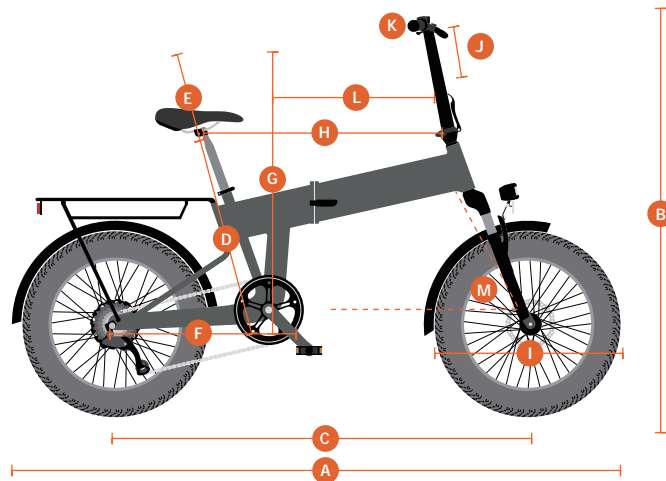
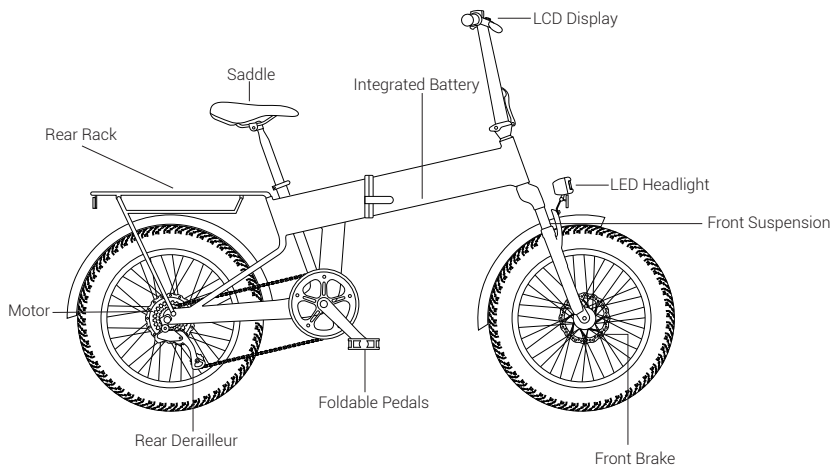



A - Total Length	63.77 Inch	H - Effective top tube	24.4 Inch
B - Handlebar Height	47.2 Inch	I - Wheel Diameter	23 Inch
C - Wheelbase	46.5 Inch	J - Head Tube Length	19.3 Inch
D - Min Seat Height	70 Inch	K - Handlebar Length	22.4 Inch
E - Seat adjustment height	91 Inch	L - Frame Reach	21.2 Inch
F - Chain Stay Length	58 Inch	M - Head angle	65°
G - Frame stack	38.6 Inch		

Bike Specification

Battery	48V 10.4 Ah LG lithium battery	Pedal Assist	0~5 level pedal assist
Frame	6061 alloy frame 197x12mm rear axle	Display	KBO lcd display
Drive Unit	500W brushless geared hub motor	Recommended Rider Heights	4' 7" - 6' 3"
Headset	Headset GH-817 28.6x44x30mm Steel	Charger	US standard 2.0 A smart charger
Fork	XC-140AD-20 front suspension fork	Range	Up to 45 miles
Rear Derailleur	Shimano 7-Speed Tourney FT	Speed	20 mph
Shifter	Shimano 7-Speed Right Shift Lever SL-V4007	Handlebar	JSHH-HB-111 / 22.225.4W:620
Crankset	Crankset 170mm	Stem	25.4*75*275mm
Chainring	52T	Seatpost	33.9*350MM
Chain	KMC Z6 Chain 1/2" x 3/32", 7 speed	Saddle	Sadd A0112 / Blk 535# / Foam
Freewheel	KDF-711, 7-Speed (14-28T)	Tires	Chaoyang 20*3 fat tires
Brakes	160mm mechanical brakes	Extras	Heavy-duty aluminum kickstand
Headlight	48V US certified front light	MAX. System weight	280 lb
Throttle	Thumb throttle	Weight	55 lb

More information of KBO E-bikes:

<https://kbobike.com>  **Support**  **Support Center**

Bike Assembly Guide

◆ Preparation Checklist

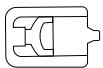

Pedals



Power cable

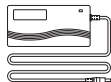

Transformer



15mm Wrench

NOTICE:

1. Please keep the original packaging for at least 30 days!
 2. Before assembling your bike, it's recommended to remove the battery for the reasons outlined below:
 - Determine if there's battery drain or damage during shipping.
 - Reduce the weight of the ebike to make it easier to maneuver the bike while assembling.
 - Avoid battery damage during the assembly process.
- Go to page [14](#) to learn about removing and charging the battery.

*Follow our Youtube channel KBO Bikes to watch bike assembly tutorials!

Assembly Instructions

◆ Handlebar Installation

Step 1: Unlock the stem clamp and gently slide the handlebar into the slot.

Step 2: Raise the handlebar to your preferred height.

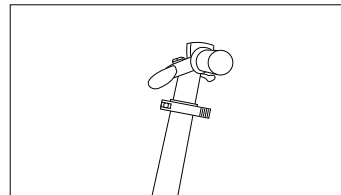
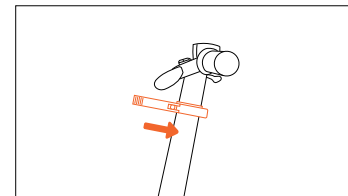
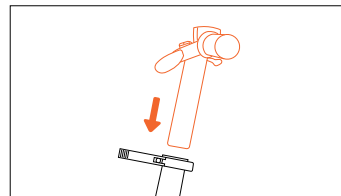

Step 3: Securely fasten the clamp to lock the handlebar in position. Engage the clamp to lock the handlebar into place, confirming that it is secure and the handlebar does not move before use.

NOTICE: Ensure handlebar length does not exceed 6.7 inches. Tighten firmly before riding to prevent any movement. For those without experience, we recommend having a professional make such adjustments for safety reasons.

Step 4: Straighten the stem into its upright position. Firmly push the clamp towards the stem. A distinct 'click' sound indicates a successful and secure attachment.

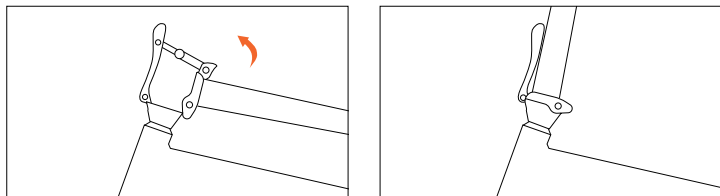

Step 5: Unfold the front section of the folding bike 180 degrees until it is parallel with the rear section. Press down firmly on the button until a clicking sound confirms successful engagement.

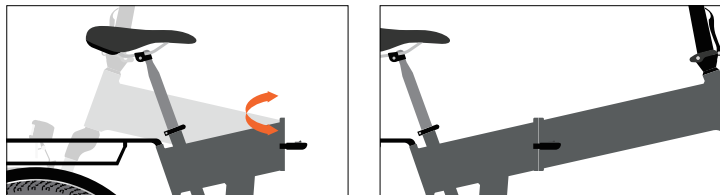

WARNING: Ensure a 'click' sound is heard for secure assembly. Before riding, always check for any looseness at the folding joints to prevent safety hazards.

◆ Pedals Installation (15mm wrench)

Make sure your pedals are installed on the correct side, as installing on the wrong side will damage the threads. Indicators for the right pedal (R) and the left pedal (L) can be found in two places: the stickers on the plastic cover, and the bottom of the pedal threads.

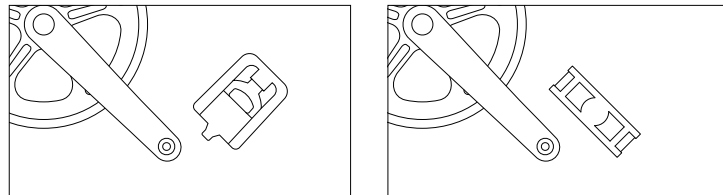

Before you install the pedals, apply a small amount of waterproof grease onto the spindle. Start threading the pedal on by hand to ensure the pedal is going in perfectly straight, rotating in the direction of the pointer shown on the crank. If it is not spinning smoothly, make doubly sure that you have the correct left or right pedal. After initial hand-tightening, finish tightening the pedals with a standard 15mm wrench.

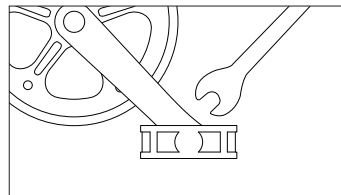

◆ Seat Adjustment

Adjust the Seat Height:

Open the seatpost quick release lever. Adjust the seatpost height by sliding the seatpost up or down to a height appropriate for your leg length and preferred riding position. Do not extend the seatpost beyond the minimum insertion marking etched onto the seatpost.

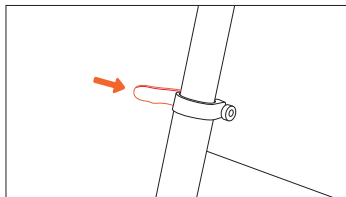
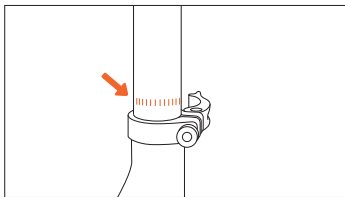

WARNING: Overextending the seatpost can cause it to break or come off your bike, putting you at very high risk of serious injury or death. Avoid this danger by inserting your seatpost into the seat tube far enough that the minimum insertion point is no longer visible.

◆ After Bike Assembly

Please write down the serial numbers found on the head tube, battery and motor on the inside front cover of this manual to facilitate failure reporting. Make sure each letter and number is correct.

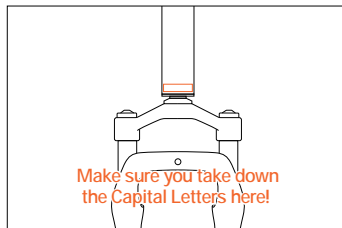

Bike frame number

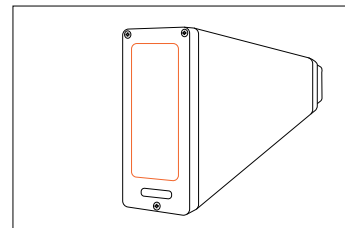

Battery serial number

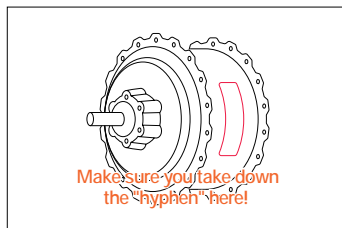

Motor serial number

NOTICE:

1. Prior to riding your e-bike, please familiarize yourself with the local laws and regulations relevant to bicycle use in your region. This includes any restrictions on where you can ride, as well as mandatory helmet use, age limitations, driver's license requirements, and lighting equipment for bicycles.
2. Ensure compatibility of any add-ons like cargo or child trailers with your e-bike. Adhere strictly to the installation guidelines provided by both the accessory manufacturer and the retailer.

How to Fold Your E-bike

Learn to fold your e-bike in 20 seconds. Please take note that to ensure optimal riding safety, the bike's clamps are engineered to lock very securely. You may need to exert more force than usual to unlock them.

Step 1: Place your hand where you see the orange marking. Squeeze towards yourself to unlock the pedal. The pedals are designed to fold 90 degrees up or down. The steps to unfold the pedals are the same as those for folding.

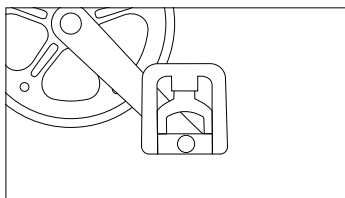
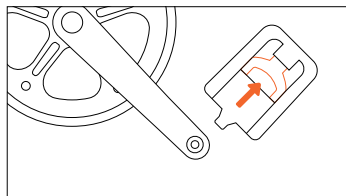
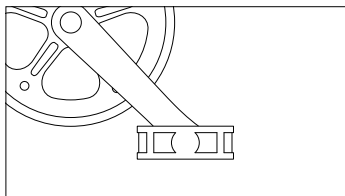

NOTICE: After folding the bike, please ensure the handlebars are positioned in a free space. Avoid unexpected compression and improper storage as this could potentially cause mechanical failure.

Step 2: Stand to the left side of your e-bike. With your left hand, slide the button toward the left to initiate the unlock sequence. Simultaneously, reach under the clamp with your right hand and apply outward pressure with both hands to release the clamp.

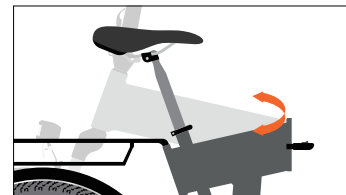
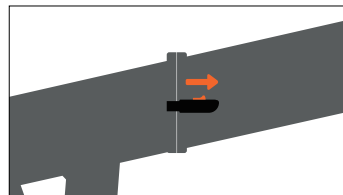

Step 3: Lift the circular button marked with orange upward and twist the stem's clamp outward to open it.

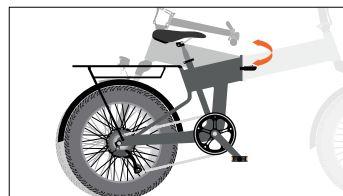
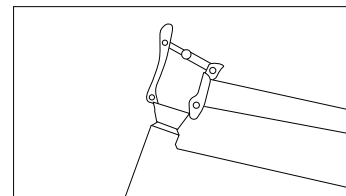
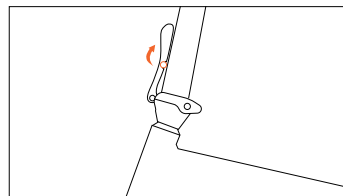

Basic Display Settings

◆ Display Screen

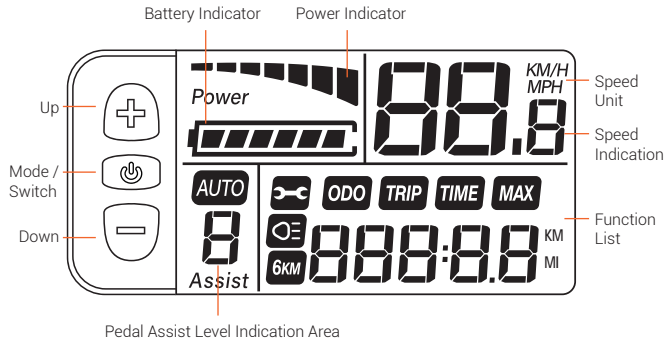

◆ General Settings

To access the settings interface, simultaneously hold the "+" and "-" buttons for 2 seconds. Use the "+" and "-" buttons to navigate and select parameters. To exit the settings, press "+" and "-" together for 2 seconds.

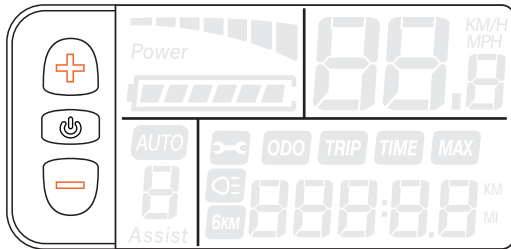

◆ Dormant Time

Set the dormant time from 0 to 60 minutes.

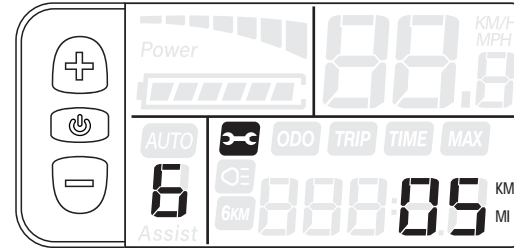

◆ Unlocking the Settings

In the settings interface, press and hold the "+" button for 2 seconds. Enter the password '0510' and press the "+" button to unlock the settings.

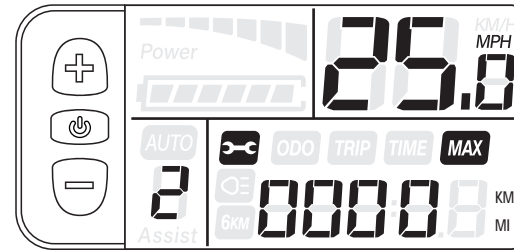

◆ Single Trip Mileage

Press "+" button to reset to zero.

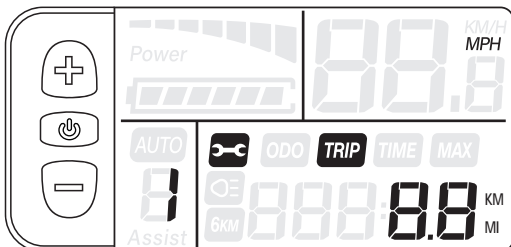

◆ Maximum speed setting

Adjustable within the range of 6 mph to 20 mph. (Do not adjust if not required.)

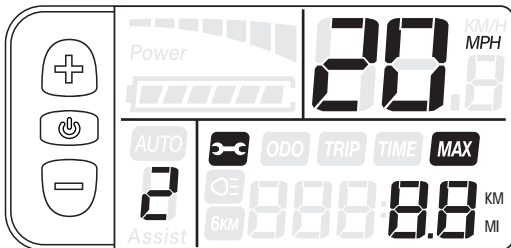

◆ Wheel Diameter Setting

This adjusts the wheel dimension and circumference. (Unlock the setting to adjust.)

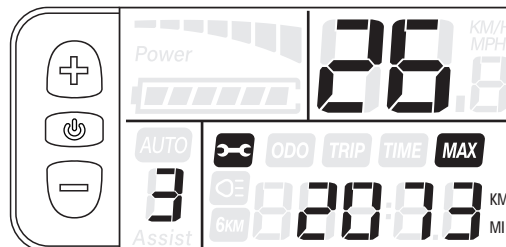

◆ Unit of Measure for Speed

Choose either km/h or mph.

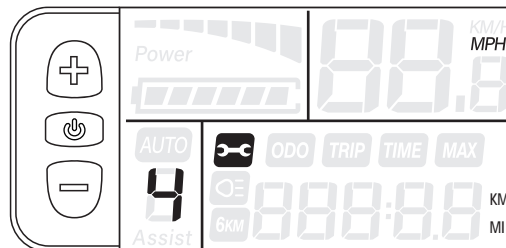

◆ Voltage Settings

Select from 24V, 36V, or 48V.

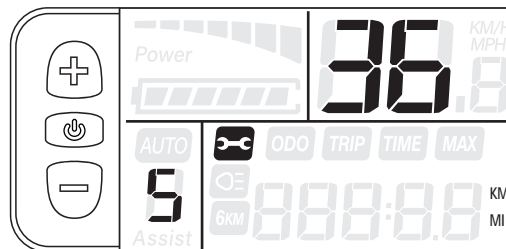

◆ Line Order Definition

Standard Line Order	Line Color	Function
1	Red	Battery positive pole
2	Blue	Electric lock
3	Black	Battery negative electrode
4	Hispid Artharxon	Instrument Communication Signal Receiving (RXD)
5	Yellow	Instrument Communication Signal Transmission (TXD)

◆ Error Code

Error Code	Definition
09	The instrument communication is received as abnormal
21	Current anomaly
22	Turn the abnormal
23	Motor phase deficiency
24	Motor Hall signal is abnormal
25	Brake abnormality (startup detection)

Safety Checklist

Safety Check	Basic Steps
Brakes	<ul style="list-style-type: none"> o Test front and rear brakes for proper function. o Ensure brake pads are not worn and are correctly positioned in relation to rims. o Make sure brake control cables are lubricated, correctly adjusted and display no obvious wear. o Check that brake control levers are lubricated and tightly secured to handlebars.
Wheels and Tires	<ul style="list-style-type: none"> o Inflate tires to within recommended limits displayed on sidewalls. o Check for bulges or signs of excessive wear. o Clean tires to ensure tread is exposed. o Ensure rims run true and have no obvious wobbles or kinks. o Check that all wheel spokes are tight and not broken. o Check the wheel balance in Pedal Only Mode. If you notice the riding is imbalanced or the rotation of the front wheel makes noise, it means the bolts were not completely tightened or not aligned horizontally.
Chain	<ul style="list-style-type: none"> o Check that chain is oiled, clean and runs smoothly. o Use extra care in wet or dusty conditions.
Cranks and Pedals	<ul style="list-style-type: none"> o Securely tighten pedals to cranks. o Ensure cranks are securely tightened and are not bent.
Derailleurs	<ul style="list-style-type: none"> o Check that derailleur(s) are adjusted and functioning properly. o Ensure shift and brake levers are attached to handlebar securely. o Check all brake and shift cables for proper lubrication.
Motor Drive	<ul style="list-style-type: none"> o Ensure the geared hub motor is spinning smoothly and the motor bearings are in good working order. o Check that all power cables running to geared hub motor are secured and undamaged. o Make sure geared hub motor axle bolts are secured and all torque arms and torque washers are in place.
Battery Pack	<ul style="list-style-type: none"> o Ensure battery is charged before use. o Check for any visible damage to the battery pack. o Lock the battery securely into frame.

Safety Precautions

The following safety notes provide additional information on the safe operation of your KBO bike and should be closely reviewed. Improper operation, or failure to confirm correct installation, compatibility, and maintenance of any component or accessory may result in serious injury or death.

◆ Before Riding

- Please thoroughly read and understand this manual, as well as any supplementary component manuals, before operating your e-bike for the first time.
- Familiarize yourself with all operating instructions and heed all safety warnings.
- Refer to the safety checklist on page [12](#) to verify proper setup and secure fastening of all parts before initial use, and then periodically thereafter.
- Confirm that the bike is appropriately adjusted to your size before you ride it for the first time.
- You are responsible for knowing and adhering to all local laws and regulations applicable to riding this e-bike in your area.
- Replace the brake pads if they are contaminated or worn down to less than 1mm in thickness, or if the total thickness is less than the manufacturer's specification.

◆ While Riding

- **Helmet Safety:** Always use a certified bicycle helmet. Proper fit and maintenance according to the manufacturer's instructions are essential. Helmets are crucial for preventing serious head injuries.
- **Pedal Assist Caution:** The e-bike's pedal assist can be powerful. Use level 0 for manual pedaling in traffic or crowded areas to control speed and prevent unexpected surges.
- **Off-Road Riding:** When riding off-road, stay alert and wear appropriate protective gear. It's safer to have a riding companion in remote areas.
- **Night Riding:** Keep your lights on and ensure reflectors are intact for visibility at night. Regular checks are important for your safety.

Battery Charging

◆ Charging Procedure for On-bike Charging

Step 1: Check the battery power indicator on your display.

Step 2: Assemble the charger as shown in Figure 1 by inserting the plug (Plug 1) into the transformer.

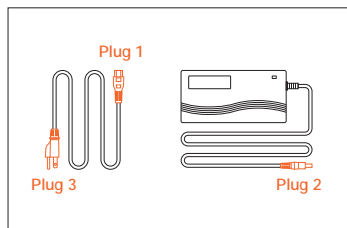

Figure 1

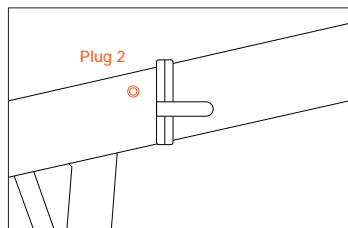

Figure 2

Step 3: Remove the rubber cover on the charging socket and insert the DC plug (Plug 2) of the charger into the battery charging socket (fig. 2).

Step 4: Connect the power plug (110V-240V plug) to the power socket.

NOTICE: Adhering to this protocol maximizes battery longevity and minimizes potential damage from incorrect charging practices.

◆ Charging Procedure for Off-bike Charging

Step 1: Fold your eBike according to the folding mechanism specified in the user manual.

Step 2: Insert the key and turn it counterclockwise 90 degrees to unlock the battery lock.

Step 3: Slide the battery sideways and pull it downward to remove it from the eBike.

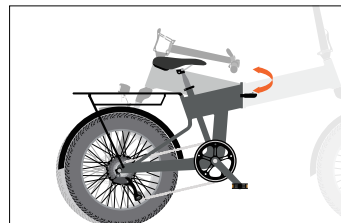

Figure 3

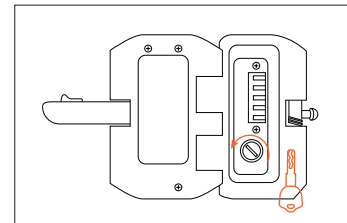

Figure 5

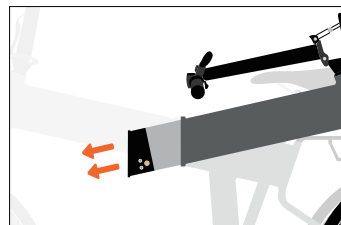

Figure 4

NOTICE: Please keep your key and its spare in a safe place. Once lost, they are difficult to copy. The key number correlates to the number on the keyhole (fig. 4). If you have lost the keys, you can give us the key number to get new keys.

Step 4: Safest way to charge your battery-

1. First, assemble the charger by inserting the plug (Plug 1) into the transformer.
2. Then insert the DC plug (Plug 2) into the battery charging socket.
3. Last, insert the power plug (Plug 3: 110V-240V plug) into the power socket.

Adhering to this 1-2-3 order is critical for promoting battery durability and mitigating the risk of damage due to improper charging techniques.

Project	Unit	Minimum	Max
Battery Input Voltage	V	28	55
Standby current	mA		0.1

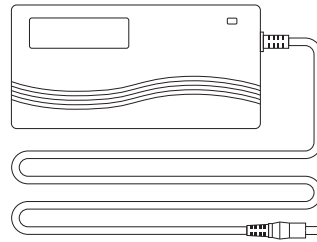
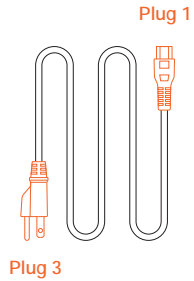

◆ Before Riding

Ensure that the battery has been properly secured to the bike before each use by grasping the battery pack and pulling upwards, testing the security of the pack.

NOTICE:

If your battery displays abnormal charging behavior, such as:

- Longer-than-expected charge time
- Strange smell, smoke, or liquid emanating from battery and/or charger
- Overheating battery and/or charger

Please stop charging and contact KBO Bike immediately.

◆ Charging Tips

- The battery can be recharged on or off the bike.
- A new battery may take longer to be fully charged when depleted.
- The charger will automatically stop charging once the battery pack is fully charged.
- You can recharge the battery after short rides as it does not have a memory effect.

◆ Precautions

- While charging, please keep your battery away from direct sunlight, liquid, dirt or debris, and metal objects. Do not allow the battery to be charged in environments under 14° Fahrenheit (-10° Celsius) and over 104° Fahrenheit (40° Celsius).
- Do not cover the charger when charging.
- Keep the battery away from children while charging.
- Make sure to only use an approved KBO Bike charger purchased directly from KBO Bike for your specific bike serial number.

◆ After Charging

1. Please unplug the main power supply first by removing the plug from the power socket, then remove the DC port from the battery. You can then check the battery status on the display screen
2. Hold the battery with one hand and turn the release switch with the other hand to install the battery. Lock the battery when finished to prevent theft.

NOTICE: It is not recommended to make any modifications to the battery or the motor. If the battery is tampered with, and there are any problems with the altered battery or motor, it will not be covered under KBO's warranty.

◆ Charger Care information

Please refer to the instruction manual in the charger box.

Riding Modes

◆ Pedal-assist

Pedal-Assist is an operating mode on e-bikes designed to engage the motor to assist, but not replace, your own pedaling effort. When you are operating your bike in the pedal assist mode, you can adjust the setting according to your preference. KBO has five pedal assist settings - ranging from 1 to 5.

- Higher pedal settings (L4/5) would be most helpful for those who want to ride faster with minimum effort. These settings are perfect for people who want to arrive fresh and timely at work, without being sweaty and exhausted.
- Lower pedal settings (L1/2) are popular for KBO riders to use after work, or when leisurely exercise is preferred. These are best to use on the way home from work, to refresh yourself and relieve stress accumulated throughout the entire workday. Moreover, lower settings can extend usable range for longer rides, maximizing enjoyment while minimizing physical stress and fatigue.

◆ Throttle-only

The throttle mode is similar to how a motorcycle or scooter operates, alleviating the need to pedal or providing an additional boost simply by twisting the throttle. KBO Ebike can reach speeds of up to 25 miles/h with throttle mode, which not only allows you to travel faster, but also reassures riders with extra power whenever needed, depending on traffic conditions and rider energy levels. If you are an adventurer who chases after speed and distance without compromising comfort or safety, the throttle-assisted KBO would be your perfect companion.

◆ Pedal-only

In this mode, the KBO will perform like a normal bike, as you'll be riding without any assistance from the motor. This mode is especially useful if you run out of battery, or are looking for more intensive resistance training.

We suggest that you select a lower assistance level when you first ride your KBO Bike. After becoming more comfortable with the riding characteristics of our e-bike, and more familiar with the varying range requirements of your most common destinations and commuting routes, you can then make any needed adjustments to pedal assist settings, as well as throttle use frequency, riding position, etc.

NOTICE: Shift gears regularly for optimal cadence and downshift before stopping the bike. Before shifting gears, reduce the force of your pedal strokes to avoid premature wear.

Riding Limitations

Following are some limitations needing riders' careful attention to ensure the geared hub motor does not overheat or become damaged from excessive loading:

- Do not attempt to ride up hills steeper than 15% grade.
- Use the pedals to assist the motor when climbing hills and accelerating from a stop.
- Avoid sudden starts and stops.
- Generally accelerate at a moderate pace, rather than aggressively.

Storage And Transport Instructions

Maximize your KBO Bike's care with these essential tips for parking, storage, and transport:

- Always switch off the power when walking with your bike to prevent unintended acceleration, or simply engage Walk Mode.
- Protect your bike from the elements; avoid extended outdoor exposure in harsh weather despite its IPX4 Water Resistance.
- Conserve energy by turning off the power and lights when parked, remove the key, and lock the battery onto the frame.
- Secure your bike with a lock in public spaces to deter theft.
- Use only compatible racks designed for your bike's dimensions and weight. For easier transport, detach the battery to lighten the load.
- For periods of non-use, charge the battery 50-60%, switch off all systems, and disconnect the battery to enhance its longevity.
- Store your e-bike in a stable, cool, and dry environment for long-term preservation.

Carrying Loads & Cargo

Total Payload Capacity of KBO K1: 280 lb. Weight: 55 lb.

◆ Cargo Safe Operation Tips:

The following list provides important tips for the safe operation of the KBO Ebike when used for carrying cargo:

1. Make sure to load the cargo as low as possible to lower the center of gravity and improve stability.
2. Ensure your loads are properly secured and periodically check that nothing has loosened.
3. Plan your route accordingly when cargo is loaded on the KBO Ebike, considering hill climbing ability, steering, and braking. Also account for moderately reduced range when carrying extra cargo weight (or an additional passenger).
4. Try to get a feel for the cargo load in a flat and open private area before riding on public roads.
5. Make sure to not use the front brake by itself, with or without cargo. Always apply the rear brake first followed by the front brake. Failure of the front fork or loss of control is possible when the front brake is operated independently, especially at higher speeds.
6. The kickstand is not designed to hold the bike upright with cargo by itself, always manually hold the bike upright when loading or carrying cargo.

WARNING: Different materials and components may respond differently to stress and wear. If a component's service life is exceeded, it can suddenly fail and there is a risk of injury. Any form of cracks, scratches or color changes on highly stressed components indicate that the component life has expired and the part should be replaced.

Safety and Care Instructions

To ensure safe riding conditions and maximize e-bike longevity, you must follow the guidelines outlined below:

- To clean the e-bike, wipe the frame with a damp cloth soaked in a mild, non-abrasive, non-corrosive detergent mixture. Wipe or spray all unpainted parts with anti-rust treatment after being used in coastal areas or areas with salty air or water.
- Never use a pressure washer when cleaning your bike.
- Never immerse the bike or any components in water, as the electrical system may be damaged. If the hub and bottom bracket bearings have been submerged in water, they should be removed and re-greased (this will prevent accelerated bearing deterioration).
- Periodically check wiring and connectors to ensure there is no damage, and the connections are secure.
- Store under shelter, avoiding extended exposure to cold or inclement weather. If exposed to rain or excess moisture, dry your bicycle afterward and apply anti-rust treatment to the chain and any other unpainted steel surfaces.
- Regularly clean and lubricate all moving parts, tighten components and adjust as required.
- Your cables, spokes, and chain will stretch after an initial break in period of 80-160 km, and additionally bolted connections can loosen with time and usage. Therefore, we suggest you contact a certified bicycle mechanic every two months to ensure your bike is safe and problem-free for years of use.
- If the paint has become scratched, or the metal chipped, use touch-up paint to prevent rust (clear nail polish can also be used as a preventative measure).
- Damage from corrosion is not covered under warranty, therefore special care should be given to protect and extend the life of your bike.

Maintenance

◆ Battery Maintenance (48V 10.4AH LG Lithium-ion battery)

1. Don't fully drain your battery. Turn off the power when the battery charge is low.
2. Fully charge the battery after each use, no matter how much power is used. This will prolong the battery life. If the battery is not used for a long time, store the battery with a full charge and charge it once a month.
3. The KBO Bike can be safely ridden in light rain. However, riding through very heavy downpours or through flooded streets is not recommended, as the crank and/or motor can get wet, which may cause problems.
4. Keep the battery away from open flame or a high-temperature heat source. Do not expose the battery to direct sunlight or recharge immediately after use in high-temperature weather.

◆ Motor Maintenance (500W geared hub motor)

1. Please check your motor frequently and tighten any loose screws or nuts, to prevent the vehicle from breaking down due to disconnected wires.
2. The geared hub motors are not waterproof, so avoid riding through water deeper than the lower edge of the geared hub motor to avoid motor failure.

◆ Chain Maintenance

1. We recommend cleaning the chain after each ride, especially in rainy and humid environments. Use a dry cloth to wipe the chain and its accessories clean. Use a brush to remove sand and dirt stuck in the chain, along with use warm soapy water if needed. Do not use strong acidic or alkaline cleaning agents (such as rust remover), because these chemicals can damage the chain.
2. Apply lubricating oil after cleaning to avoid rust. First, make sure the chain is dry, and then apply the lubricating oil into the bearings.
3. To prevent unnecessary chain wear, try to maintain a vertical chain position when shifting gears (do not use the smallest gear with the smallest flywheel, or the largest gear with the largest flywheel, etc.).

◆ Front Fork Maintenance

1. Always use a clean, oil-free lint-free cloth with plain or soapy water to clean your bike. To prevent water from flowing into the front fork, you can turn the bike upside down. Dry with a lint-free towel after washing. Pay specific attention to the inner tube and the dust seal to reduce wear and prevent thinning of the inner tube, which can lead to significant damage if the aluminum is exposed to air.
2. We recommend using a front fork dust cover to protect the inner tube of your front fork. This prevents dust from entering as well as hard objects from hitting the inner tube.

Warranty

KBO Bikes periodically updates our official Warranty Policy. Therefore, please review the latest policy on our website:

<https://kbobike.com/pages/warranty>

After-sales Mail: support@kbobike.com

Suggestion Box: info@kbobike.com

* KBO has the right, without notice to the consumer, to substitute components of at least equal quality for advertised KBO e-bike components if those advertised components are unavailable.



**Best Choice
For Your First E-bike**