

ELECTRIC BICYCLE USER MANUAL



Read Carefully Before Use
Keep for Future Reference

Safety Information

Warning!

- Assemble and adjust this bicycle **ONLY** in accordance with these instructions. Read them completely prior to assembly and use. Contact customer service if any point is unclear. Provide this manual to anyone who will use this bicycle and provide it with this bicycle (whether already assembled or not) if it is ever given or sold to a third party. Failure to follow these instructions may lead to serious personal injury and property damage, possibly including death.
- **ALWAYS** obey all applicable local and national laws and regulations while riding. Do not ride this bicycle in any area prohibited to electric bicycles. Always wear your helmet and other required protective gear. Always maintain your reflectors and other required safety equipment.
- Check whether the brakes function well using the brake levers **BEFORE** riding. Even after power is cut to the motor, the inertia of the bike will often require active braking power.
- **ALWAYS** ensure all fasteners and components are intact and securely tightened before and after every use.
- **DO NOT** ride this bicycle if any part is damaged or shows any sign of malfunction. Repair or replace worn and broken components before further use. Never replace any parts with nonidentical ones.
- **DO NOT** allow children or persons unfamiliar with this bicycle or these instructions to operate it. Do not ride it while you are tired or under the influence of drug or medication.
- **DO NOT** wear loose footwear or clothing that may become caught in the wheels or any other moving parts.
- Pay attention to your remaining power before setting out and during use. Recharge your battery as needed to ensure it never runs out of power at a moment where you are taken by surprise.
- It is recommended that you not ride your bike fast when getting started. This can be ensured by setting the bike's top speed low until you are fully familiar with your new electric bike and its controls.
- **ALWAYS** be alert for people, animals, or any obstacles that may appear in front of you while riding your bicycle. Be aware that pedestrians and drivers may not expect the speed or responsiveness of your bike. Adjust your behavior accordingly. It is advisable to install warning devices to draw their attention, but always be ready to turn safely out of their way if needed. Do not focus on the display panel for extended periods of time while riding.
- **NEVER** ride at a speed where your stopping distance exceeds your visibility. We do not recommend that you ride your bicycle at night or in an environment with poor visibility. If you have an emergency that makes it necessary to do so, keep your light on and limit your speed appropriately.
- **NEVER** use the throttle, pedal assist system (PAS), cruise control, or push assist in any situation, road condition, or terrain where doing so might impair your control of your bicycle.
- **DO NOT** load this bicycle with more than 330 pounds (150 kilograms).
- **NEVER** adjust the 03, 06, 07, 13, 14, or 15 parameters in the display menus. Adjustment of these parameters should only be made when using the display panel with other motorized wheels of differing voltage, diameter, or magnetic arrangement. In any other case, any adjustment of these parameters should be undone **IMMEDIATELY**. Restore the original settings before any further use of this bicycle.

- **ALWAYS** avoid direct pressurized spray that might allow the interior of the battery, display panel, front light, and other electronic components to become wet. If the interior of the battery accidentally becomes wet, replace it with a new identical one. For the other electronic parts, wait for them to completely dry before any further use.
- **ALWAYS** turn off the battery between uses and fully disconnect it before any cleaning, servicing, and storage.
- **NEVER** place the battery near heat sources or explosive or flammable gases. Never expose it to radiation or excessive pressure. Only charge the battery in locations with an ambient temperature between 32°F/0°C and 110°F/45°C.
- **NEVER** modify the battery or power cord. Only use the provided charger with this bicycle. Never get the charger or power cord wet or operate them with wet hands.
- If the battery is ever damaged, avoid all contact with it or any leaking fluid. Remove contaminated clothing and flush with copious amounts of water if contact accidentally occurs with the skin. If contact accidentally occurs with the eyes, **IMMEDIATELY** flush them with copious amounts of water for at least 15 minutes while seeking medical attention.

Specifications

Motor Power		500 W	
Wheel	Total Diameter	24 in. ("06"=24.0)	61 cm
	Wheel Frame Diameter	20 in.	50.8 cm
	Tire Type	20"×4.0" Fat Tire	
Magnet Arrangement	Speed Sensor	1 Alnico Magnet ("07"=0001)	
	Pedal Assist Sensor	12 Alnico Magnets ("13"=0012)	
Battery	Type	36V Lithium ("03"=0036)	
	Weatherproofing	IPX4	
	Operational Temp. Range	-4 to 104°F	-20 to 40°C
	Charging Temp. Range	32 to 110°F	0 to 45°C
	Optimal Storage Temp. Range	32 to 104°F	0 to 40°C
Display Panel	Weatherproofing	IPX7	
Front Light	Weatherproofing	IP65	
Control Hardware	Current Limit	15 A ("14"=0015)	
	Undervoltage Lockout	29 V ("15"=29.0)	
Est. Operational Range	Throttle Control	37 mi.*	60 km*
	PAS Control	50 mi.*	80 km*
Max. Speed		20 mph*	32 km/h*
Weight Capacity		330 lb.	150 kg

* Based on unloaded wheel rotation at full power without friction with software limitations. True speed will vary according to variables such as battery strength and load but should remain within ±1 mph of the displayed speed.

* Based on a 154 lb. or 70 kg load at full power and at full legal speed on actual roads.

Product Diagram



Handlebars

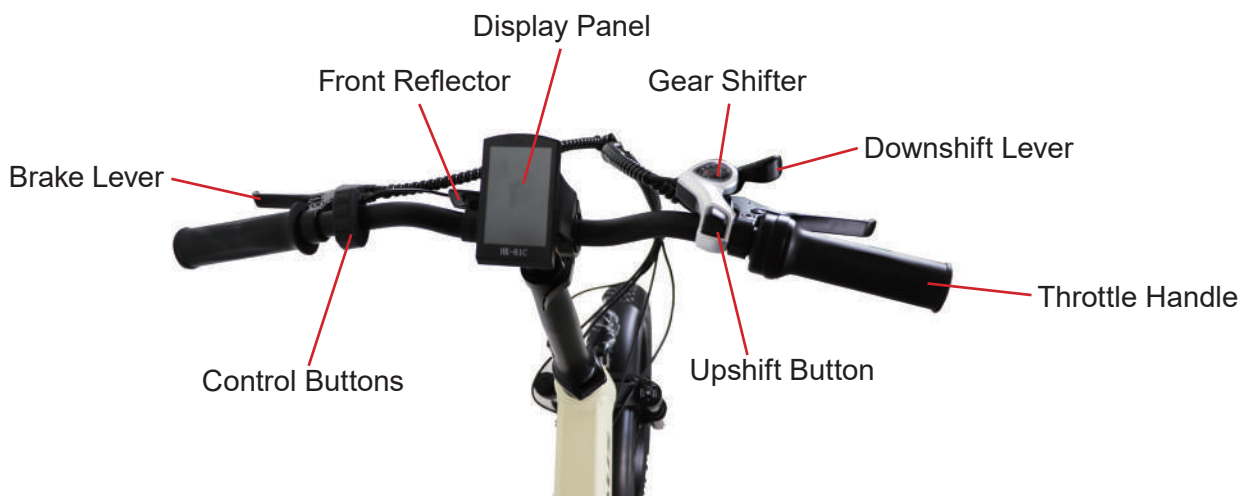

Control Buttons

- + Increases the pedal assist level or toggles values up when pressed. Turns the front light on and off when held
- i Toggles the variable display when pressed. Turns the display panel on and off when held
- Decreases the pedal assist level, turns off the motor, or toggles values down when pressed. Turns cruise or push assist control on and off when held



Display Panel

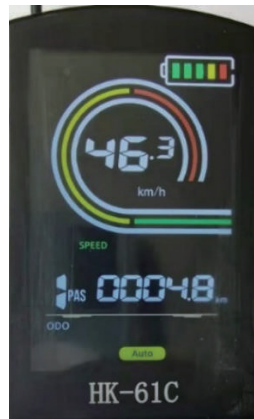

The battery display shows your remaining battery power level.

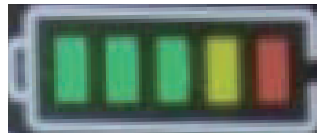

100% 80% 60% 40% 20%

The number in the upper circled area is one of the speeds in mph or km/h, i.e., the current speed (SPEED), the maximum speed (MAX), and the average speed (AVG), or an error code.

The number before “PAS” is the current pedal assist level.

The number on the lower right is a variable display that may show your current trip distance (TRIPA), your total distance traveled (ODO), your current running time (TM), and your battery’s voltage (VOL).

The bottom line displays when the display panel turns on (Auto), when cruise control activates (Walk Cruise), or when push assist control operates (Manual).

☺ is displayed when the front light is on.

Package List

When you first get your new electric bike, carefully unpack all of the following components and accessories. Check that nothing is missing or has been damaged in transit. Keep children away from the packaging or provide constant supervision. Storing your original packaging through the warranty period will speed returns if any are needed.

Item	Name	Qty.
1	Bicycle Frame with 36V Battery, Control Hardware, Chain, Rear Derailleur, Seat, Front Light, Fenders, Motorized Rear Wheel, & Standard Front Wheel	1
2	Handlebars with Throttle, Gear Shifter, Control Buttons, Display Panel, & Front Reflector	1
3	Pedals	2
4	Charger	1
5	Power Cord	1
6	Keys	2
7	13×15mm Wrench	1
8	8×10mm Wrench	1
9	M5 Hex Wrench	1
10	M6 Hex Wrench	1
11	Phillips Screwdriver	1

Assembly



Wear hand and eye protection during assembly to prevent accidents.

1. Place the bicycle frame on firm level ground. Raise the handlebars into place on the head tube and secure them using the locking lever.

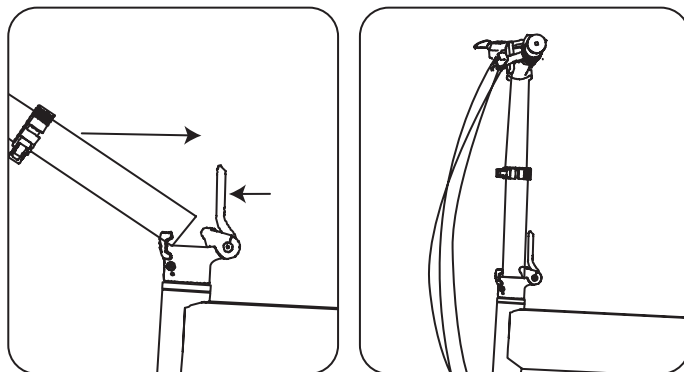

2. Screw the pedal labeled **L** onto the left crank arm and the pedal labeled **R** onto the right crank arm, tightening their locking nuts with the 13×15mm wrench.

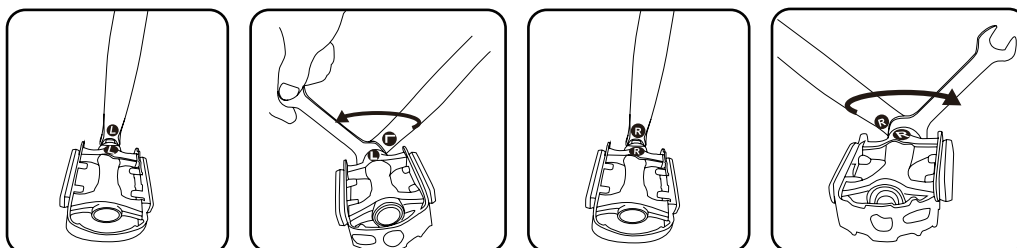

3. Unfold the bike frame completely and lock its central part using the latch.

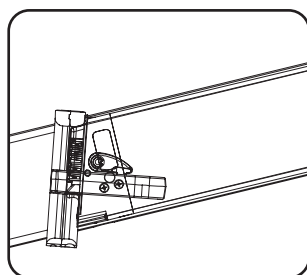

4. Insert either of the provided keys into the hole underneath the battery compartment. To activate the battery, turn the key completely clockwise. To deactivate it, turn the key back for one position. To unlock it for removal, turn the key completely counterclockwise.

Operation



Your battery was charged at the factory but may have run down during shipping. Check the battery's remaining power for the first use and refill it using the provided charger as described in the Charging section below.



Between uses, always turn off the battery and remove the key to prevent unauthorized use.

Pedal Assist Control

The pedal assist system (PAS) requires you to continue using the pedals to keep the motor active but provides additional speed and strength as you ride. By default, the PAS has five levels and a 20 mph or 32 km/h top speed. This top speed can be adjusted. If it is, the lower levels will run at 93.7%, 78%, 62.5%, and 46% of the new top speed.

Level	0	1	2	3	4	5
Speed	—	9 mph	12.4 mph	15.5 mph	18.6 mph	20 mph
	—	15 km/h	20 km/h	25 km/h	30 km/h	32 km/h
	0%	46%	62.5%	78%	93.7%	100%

The PAS can also be adjusted to use three levels instead.

Level	0	1	2	3
Speed	—	9 mph	15.5 mph	20 mph
	—	15 km/h	25 km/h	32 km/h
	0%	46%	78%	100%

By default, the PAS is activated at Level 1 as soon as the display panel turns on. The bike will accelerate to the speed of the current level (9 mph or 15 km/h) as soon as the pedals fully turn two times. Press **+** to go up one level. Press **-** to go down one level.

The PAS automatically pauses and the motor temporarily shifts to neutral in the following cases:

- You stop pedaling
- You press either brake lever
- Your bike accelerates on a slope to a speed faster than the top speed.

The PAS reactivates at its current level once both brakes are released, your speed is at or below the current target, and you resume pedaling. Going from Level 1 to 0 also disables the PAS and puts the motor in neutral until **+** is pressed, restarting PAS at Level 1.

If you turn the throttle handle while PAS is active, the bike will activate throttle control and accelerate to its top speed. If you turn off the display panel while PAS is active, the motor will stop and the bike will only operate manually.

Throttle Control

The electric bicycle can work as a single-speed scooter using the throttle handle on the right handlebar. By default, throttle control operates at the bike's preset top speed (20 mph or 32 km/h) and is available whenever the display panel is on. Turn the throttle handle, stop pedaling the bike, and your bike will continue along at the top speed. Note that the top speed can be adjusted and some jurisdictions may require throttle control to be disabled on electric bikes. (See Parameters

08 and 10 in the Adjustment section below.)

Throttle control automatically pauses and the motor temporarily shifts to neutral in the following cases:

- You release the throttle handle completely
- You press either brake lever
- You accelerate beyond the top speed
- You disable the throttle, even without releasing the throttle handle

The motor will resume working once the throttle handle is turned again, both brake levers are released, and your speed is at or below the top speed.

If you begin pedaling while throttle control is active, the bicycle will activate PAS control. If you turn off the display panel while throttle control is active, the motor will stop and the bike will only operate manually.

Cruise Control

Cruise control allows you to ride the bike at a constant speed without turning the pedals or throttle handle. When the display panel is on, use the pedal or throttle control to reach your ideal speed, hold – until “Walk Cruise” is displayed, and stop pedaling or release the throttle handle. Your bicycle should maintain its current speed without further adjustment. To deactivate cruise control, hold – again until “Walk Cruise” disappears, press either brake lever, or turn the throttle handle to shift the bike to throttle control.

Push Assist Control

The push assist system provides additional strength as you push the bicycle for a walk or climb. After the display panel is turned on, stand beside the bike, holding – until "Manual" is displayed, and then push your bike forward, which will cause the motor to activate at a speed of 3.7 mph or 6 km/h. Holding – again until "Manual" disappears or pressing either brake lever will cease the operation of push assist control.

You can also activate push assist control by adjusting the bike's top speed to 0 and turning the throttle handle. Release to stop and adjust the top speed back to 1 or above to deactivate the option. (See Parameter 08 in the Adjustment section below.)

Manual Control

To ride your bicycle normally, leave the display panel turned off or remove the battery. (See Steps 1–2 in the Charging section below for how to remove the battery.) You can also ride normally with the display panel turned on by pressing – until the motor is put to neutral (“0”).

The Shimano thumb shifter uses a lever and a button to control the 7 rear cogs, providing 7-speed gearing for manual riding. The larger numbers represent the smallest cogs and the smaller numbers refer to the largest cogs. Press the + button at the base of the shifter to upshift and push the lever beside the shifter away to downshift.



Be sure your bicycle's crank is turning while using the shifter to adjust the chain.

If you press + while the display panel is on, the bike will activate PAS control at Level 1. If you turn the throttle handle while the display panel is on, the bike will activate throttle control and accelerate to its top speed.

Adjustment

To adjust the bike's parameters, turn on the display panel and hold + and – simultaneously to enter the adjustment menus. You will automatically start with Parameter 01 (Display Brightness). For each parameter, use + and – to change the settings and press i to save your changes and move to the next parameter. Hold + and – simultaneously again or wait for the display to automatically reset to leave the adjustment menus, saving all current changes.

WARNING!

DO NOT adjust Parameters 03, 06, 07, 13, 14, or 15 while using this display panel with this bike. Parameters 03, 14, and 15 concern details of the electricity coming from the main battery. Parameter 06 allows adjustment of the compatible wheel diameter. Parameters 07 and 13 concern the arrangement of magnets within your motorized wheel and on your PAS sensor. These can be used to modify the display panel to work with other motorized bicycles but changing any of these values during use with this bicycle **WILL** cause it to perform abnormally, malfunction, and/or break. If such adjustment happens accidentally, stop the bike **IMMEDIATELY** and **IMMEDIATELY** correct the settings.

Parameter	Value
03	0036
06	24.0
07	0001
13	0012
14	0015
15	29.0

01 Display Brightness

Press + and – to adjust the brightness of the display panel. Using the minimum setting that is clearly visible affects your battery life a very little bit but more importantly allows your eyes to go between the road and the display with less readjustment in low light conditions. Setting 0001 is dim, 0002 is medium, and 0003 is bright.

02 Measurement Units

By default, speeds and distances are displayed in US/English customary units (miles and mph). Press + and – to toggle between this and metric (km and km/h). Setting 0000 is metric and 0001 is US.

03 Battery Voltage

Never adjust this value. If it is ever changed by accident, stop the bike and reset it to 0036 before continuing on your way.

04 Timed Shutoff

By default, your display panel and motor will automatically shut off once your bike has stopped moving for 10 minutes (Setting 0010). Press + and – to adjust the number of minutes before the display shuts down between 0001 and 0060. Decreasing this setting to 0000 disables the timed shutoff, putting your display panel and motor in standby mode indefinitely when you park your bike.

05 Power Levels

By default, your PAS operates with 5 power levels (46/62.5/78/93.7/100%) and can be downshifted to Level 0 (neutral mode). Press + to toggle between this and 3 levels (46/78/100%). Press – once to disable Level 0 and twice to restore it. Settings 05 and 09 activate 5 levels of operation and enable Level 0 while Settings 15 and 19 activate 5 levels but disable Level 0; Setting 03 activates 3 levels and enables Level 0 while Setting 13 activates 3 levels but disables Level 0.

06 Wheel Diameter

Never adjust this value. If it is ever changed by accident, stop the bike and reset it to 24.0 before continuing on your way.

07 Speed Sensor(s)

Never adjust this value. If it is ever changed by accident, stop the bike and reset it to 0001 before continuing on your way.

08 Top Speed

By default, your motor has a top speed of 20 mph or 32 km/h. While in 5-level mode (See “05” above), press + and – to adjust this value. While using US customary units (see “02” above), the speeds will vary as shown:

Value	1–10	11	12	13	14	15	16	17	18	19	≥20
Level 1 (mph)	4.6	5.1	5.5	6	6.4	6.9	7.4	7.8	8.3	8.7	9
Level 2 (mph)	6.3	6.9	7.5	8.1	8.7	9.4	10	10.6	11.3	11.9	12.4
Level 3 (mph)	7.8	8.8	9.4	10.1	11.1	11.7	12.5	13.3	14.2	14.8	15.5
Level 4 (mph)	9.4	10.3	11.2	12.2	13.1	14.1	15	15.9	16.9	17.8	18.6
Level 5 (mph)	10	11	12	13	14	15	16	17	18	19	20

While using metric units (see “02” above), the speeds will vary as shown:

Value	1–16	17	18	19	20	21	22	23	24	25	26	27	28	29	30	31	≥32
Level 1 (km/h)	7.4	7.8	8.3	6.4	9.2	9.7	10.1	10.6	11	11.5	12	12.4	12.9	13.3	13.8	14.3	15
Level 2 (km/h)	10	10.6	11.3	11.9	12.5	13.1	13.8	14.4	15	15.6	16.3	16.9	17.5	18.1	18.8	19.4	20
Level 3 (km/h)	12.5	13.3	14	14.8	15.6	16.4	17.2	17.9	18.7	19.5	20.3	21.1	21.8	22.6	23.4	24.1	25
Level 4 (km/h)	15	15.9	16.9	17.8	18.7	19.7	20.6	21.6	22.5	23.4	24.4	25.3	26.2	27.2	28.1	29	30
Level 5 (km/h)	16	17	18	19	20	21	22	23	24	25	26	27	28	29	30	31	32

Adjusting this value to 0 enables push assist control. Hold the throttle to activate it, release to deactivate, and set this valve to 1 or above to disable it again.

09 Throttle Start

By default, the throttle handle instantly activates the bike's single-speed run. Press + and – to toggle between this and requiring two full rotations of the pedals before throttle control activates. Setting 0000 activates instant throttle response and 0001 activates a two-rotation start.

10 PAS or Throttle Disablement

By default, your bike offers manual, the PAS, and throttle control as explained above. Press + and – to toggle among this, enabling the PAS only, and enabling throttle control only. Setting 0000 disables throttle control. Setting 0001 disables PAS control. Setting 0002 reactivates both. (To disable both PAS and throttle control, simply leave your battery off or turn off the display panel while riding.)

11 PAS Sensitivity

By default, your bike activates its pedal assist system when you turn the pedals two full rotations while the display panel is on. Press + and – to adjust how quickly you need to turn the pedals to activate the PAS. Lower values require less pedaling and higher values more.

12 PAS Acceleration

By default, your bike ramps up the pedal assist speed for its current level smoothly and evenly. Press + and – to fine tune this acceleration to suit your riding style. Lower values accelerate more gradually and higher values more quickly.

13 PAS Sensor

Never adjust this value. If it is ever changed by accident, stop the bike and reset it to 0012 before continuing on your way.

14 Maximum Current

Never adjust this value. If it is ever changed by accident, stop the bike and reset it to 0015 before continuing on your way.

15 Minimum Voltage

Never adjust this value. If it is ever changed by accident, stop the bike and reset it to 29.0 before continuing on your way.

16 Cruise Control

By default, your bike allows you to ride with cruise control as mentioned above. Press + and – to disable or re-enable this as needed. Setting 0000 disables cruise control and Setting 0001 enables it.

17 Odometer Reset

Hold + while this parameter is active to reset your bike's total distance traveled to 0.

Charging

Periodically check your bike's current power level on the display panel. 100% indicates a full battery while 20% indicates a weak one.

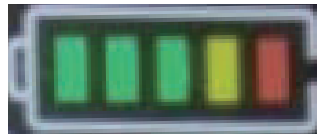

100% 80% 60% 40% 20%

When you find that recharging is necessary,

1. Connect the provided charger to the charging port inside the hole on the left side of the battery compartment.
2. Connect the charger to a stable compatible power source using the provided power cord. The charger's indicator light should turn red and charging begins.



If charging fails, secure your bike in place with its motorized rear wheel raised, run the motor using the throttle handle as described above for a short time, stop the motor, and then restart charging.

3. Periodically check the power level on the display panel. There is no need to fully recharge the battery. Either 80% or 100% should provide strong and responsive service. For best results, however, do not allow the battery to ever drain completely and avoid leaving it connected to power once it is already fully charged.
4. After charging is complete, disconnect the charger from power and the battery.

Maintenance

- Always disconnect the battery before undertaking any cleaning, maintenance, or repair. For the longest possible service life, disconnect the battery between uses.

To disconnect the battery,

1. Hold **i** until the display panel turns off.
2. Release the latch and fold the bike frame, exposing the battery.
3. Unlock battery by inserting either key and turning it completely counterclockwise.
4. Remove the key and slide the battery out of its compartment using its handle.

For reinstallation, slide the battery back in, lock it in place using the key, and close the compartment by unfolding the bike frame completely.



- Check the parts of the bicycle for any looseness, stiffness, wear, or damage after each use. Tighten, lubricate, repair, or replace any problematic parts before further use. Only replace components of this bike and its accessories with identical ones.
- The exterior of the bicycle can be cleaned with a soft damp cloth. Do not use harsh abrasives or caustic chemicals. All electronic components have waterproofing adequate for rain, but avoid direct pressurized spray that might allow the interior of the electronic components to become wet, never charge the battery while it or your hands are wet, and immediately replace the battery if it ever begins to swell or leak fluid.
- If the bicycle will not be used for an extended period of time, remove the battery and store everything in a cool dry place away from direct sunlight and inaccessible to children. Avoid storing electronics in plastic bags, which might allow humidity to build up over time. For best results, check the battery every three months. If its power sinks below 60%, recharge to at least that full before returning it to storage.

Troubleshooting

Code	Problem	Usual Solution(s)
02	Brake Lever Failure	Check the wiring and condition of the brake levers, lines, and motorized wheel. Replace any problematic parts with new identical ones.
06	Undervoltage Knockout	Refill the battery.
		Replace the battery with a new identical one.
07	Motor Failure	Retighten the appropriate wire connection(s).
		Replace the motorized wheel with a new identical one.
08	Throttle Failure	Check the wiring and condition of the throttle and motor. Repair or replace any problematic parts.
09	Control Hardware Failure	Retighten the appropriate wire connection(s).
		Check the condition of the control hardware. Repair or replace any problematic parts.
10	Communication Reception Failure	Restart the display panel.
		Retighten the appropriate wire connection(s).
		Check the condition of the display panel, throttle, pedal assist sensor disc, or motorized wheel. Repair or replace any problematic parts.

Code	Problem	Usual Solutions
11	Communication Sending Failure	Restart the display panel.
		Retighten the appropriate wire connection(s).
		Check the condition of the display panel, throttle, pedal assist sensor disc, or motorized wheel. Repair or replace any problematic parts.
12	BMS Communication Failure	Secure the bike, raise the motorized wheel, run it for a while, stop, and refill the battery.
		Replace the battery with a new identical one.
13	Front Light Failure	Retighten the appropriate wire connection.
		Check the condition of the front light. Repair any problematic parts or replace the light with a new identical one.

Disposal

Electrical products should not be disposed of with household products. In the EU and UK, according to the European Directive 2012/19/EU for the disposal of electrical and electronic equipment and its implementation in national laws, used electrical products must be collected separately and disposed of at the collection points provided for this purpose. Locations in Australia, Canada, and the United States may have similar regulations. Contact your local authorities or dealer for disposal and recycling advice.

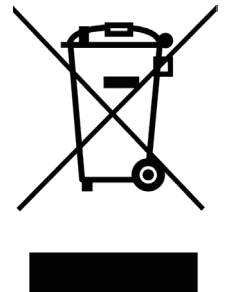

Contact Us

Thank you for choosing our products! If you have any questions or comments, contact us at help@cs-supportpro.com and we'll resolve your issue ASAP!

For a .pdf copy of the latest version of these instructions, use the appropriate app on your smartphone to scan the QR code to the right.



EBM - F 2 A B - A K
EBM - F 2 A B - A W
EBM - F 2 A B - A Y
Rev. 28 Dec. 2022