

# ML60S24DC

## Class 2 Magnetic

Outdoor Black Powder Coated Steel Enclosure

Single Circuit: **24VDC**

Total Wattage: **60W max**

Input Voltage: **120V 60Hz**



Conforms to UL STD. 1310  
Certified to CSA  
STD. C22.2 No 223  
model EM60  
[Link to certification](#)

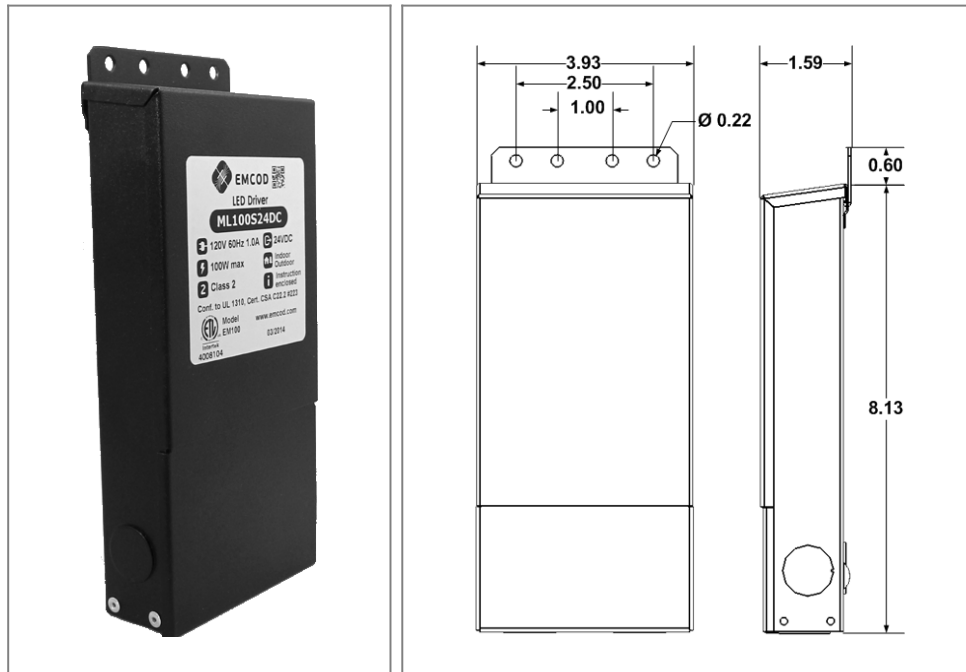

### Transformer

Temperature class B(130°C)

Input leads are 18AWG 600V

Output leads are 18AWG 300V

Leads max. operational temperature is 105°C

Thermal manually reset primary breaker 1A

Thermal manually reset secondary breaker 4A

### Housing

The actual transformer 60W is encapsulated in the enclosure

The enclosure is Black Powder Coated Steel, NEMA 3R rated

Wiring compartment has 6 knockouts sizes for 3/8 inch screw cable connectors

Enclosure Temperature does not exceed 75°C at 45°C ambient and fully loaded

Dimensions (inch): H = 8.13, W = 3.93, D = 1.59

Weight (LBs): 0.39

### Electrical Parameters

Input Voltage: **120V 60Hz**

Output voltage without load: **26.9VDC**

Output voltage fully loaded: **23.5VDC**

Max. Total Wattage: **60W**

Max. Output Current: **2.5A**

Efficiency: **85%**

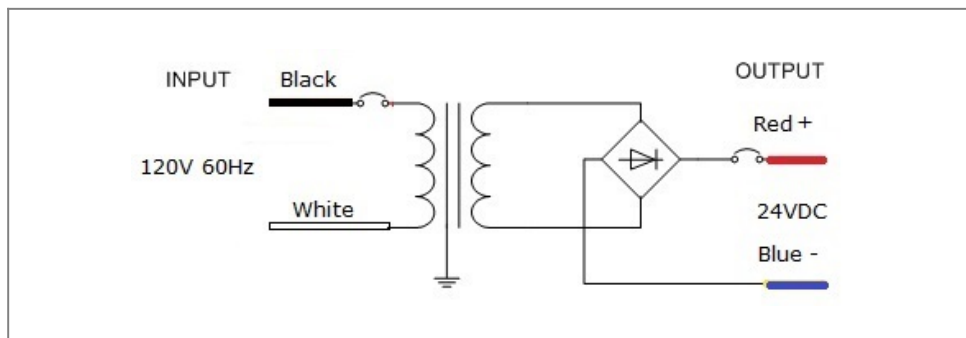

Mailing Address: 6925 Eton Ave. Canoga Park, CA 91303 Tech support: Arik Nirenberg phone: 818-904-3309 cellphone: 818-269-4091  
Fax: 818 904 3327 info@emcod.com techsupport@emcod.com