

SIEMENS



SITOP power supply

Electronic protection and fast fault localization in 24 V DC load circuits

SITOP SEL1200, SEL1400, PSE200U selectivity modules

Brochure

Edition
04/2020

[siemens.com/sitop](https://www.siemens.com/sitop)

The SITOP selectivity modules distribute the load current across several 24 V DC load circuits and monitor them reliably for overload and short-circuit conditions. The electronics permit brief current peaks caused, for example, by high inrush currents, but isolate load circuits in the event of an extended overload. This is ensured even on high-resistance lines. In such cases, miniature circuit breakers fail to trip, or trip too late, even if the power supply unit could deliver the required tripping current. The SITOP expansion modules continue to reliably supply 24 V to the load circuits not affected by an overload and can prevent a total system failure.

The new SITOP SEL selectivity modules, which have up to eight outputs, an additional tripping characteristic and detailed diagnostics, now offer even more efficient protection for your plant.

Miniature circuit breakers with high current consumption

Miniature circuit breakers are often still used for the selective protection of 24 V DC load circuits. In many cases, however, when interacting with switched-mode power supply units, they do not offer reliable protection. They require several times the rated current in order to trip within a few milliseconds. Because stabilized power supplies limit their output current electronically when there is a critical overload, the tripping current is not always guaranteed. This can cause the 24 V supply to break in and the PLC to go to Stop. Even if the power supply unit could supply the current, immediate tripping is not necessarily assured, because with this high current requirement, the line resistance can no longer be neglected. It prevents the required tripping current from flowing.

Therefore fast tripping is only possible up to certain cable lengths and starting from larger cable cross-sections. In addition to the line resistance, the overall circuit design (e.g. contact resistances at terminals) must be taken into consideration when configuring miniature circuit breakers.

SITOP selectivity modules – optimized for switched-mode power supply units

The selectivity modules are specially designed to protect 24 V DC individual load circuits supplied by switched-mode power supplies. Individual setting of the tripping current allows optimum adaptation to the respective load circuit. Engineering effort is minimal since the switch-off characteristic always guarantees reliable tripping – even with high line impedances that limit the short-circuit current.

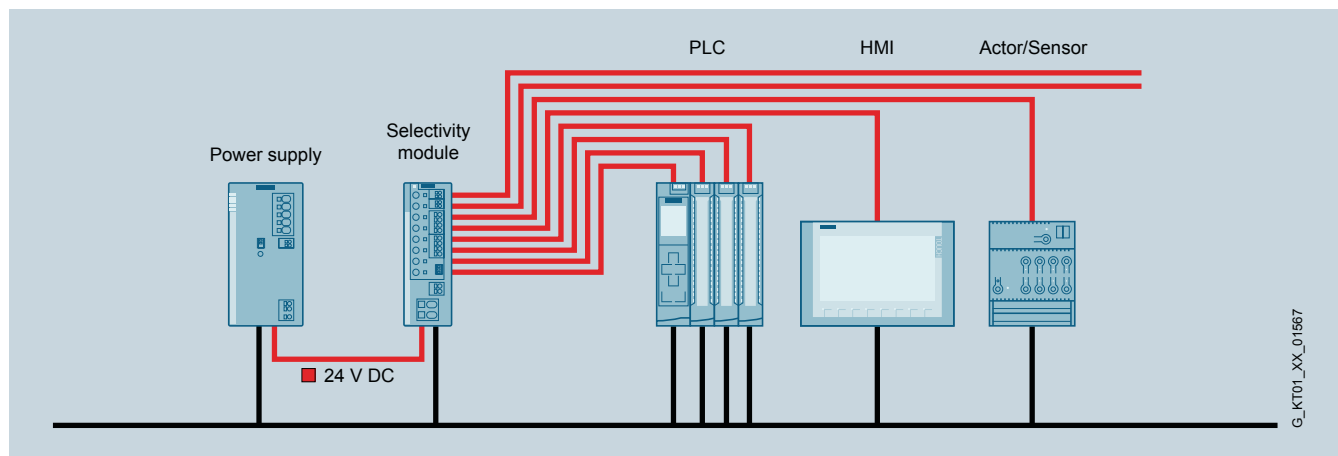

As an electronic monitor, the SITOP selectivity module switches faulty 24 V DC load circuits off immediately, and continues to supply the other loads without any interruption.

SITOP PSE200U and SEL1400 – limiting characteristic offers maximum safety

In terms of the tripping characteristic, the SEL1400 selectivity modules behave like the tried and tested PSE200U modules. They limit the output current to 150% of the set value, corresponding to the overload behavior of the SITOP power supplies of the Advanced and Standard product lines. This means that, even in the case of a short circuit, no overload can occur and consequently no voltage drop at the output of the power supply unit. Even when a power supply without overload reserves is used, the patented SITOP concept ensures reliable protection: The electronics continuously monitor the 24 V DC input voltage. As soon as the 24 V DC threatens to fail, the path with a higher current than the set current is disconnected immediately. All other load circuits continue to be supplied without interruption. Even loads that do not comply with the PLC standard and can only bridge a few milliseconds of undervoltage, continue to operate without any problem.

Tripping characteristics

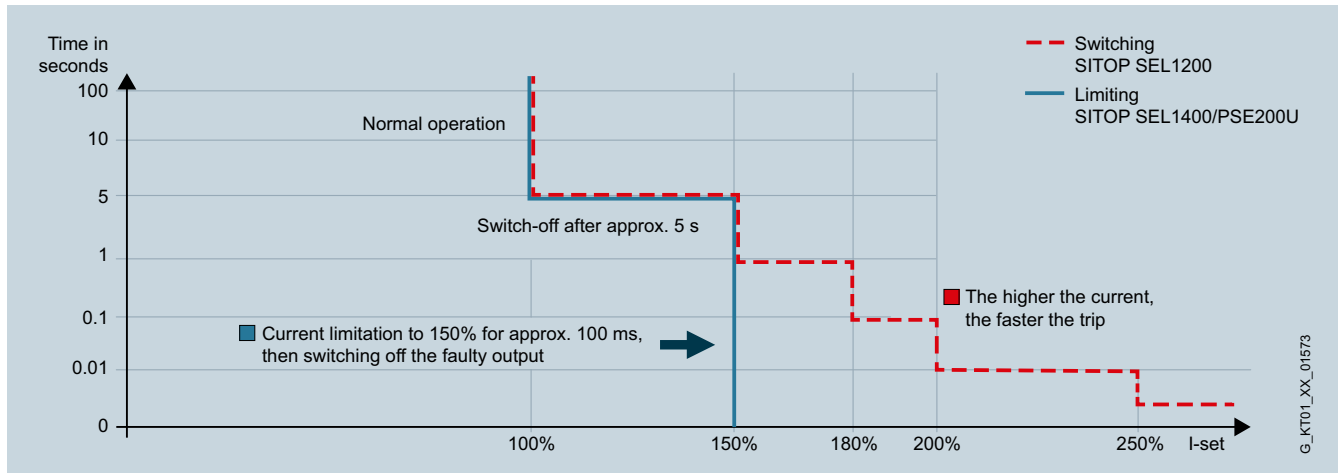

SITOP SEL1400 / PSE200U characteristic: limiting

Shutdown response for current requirement per output circuit relative to set value (I/I set value = 100%):

Power requirement:	Shutdown after:
From 0 A to 100% (set value)	No shutdown
From set value to 150% ¹⁾	Approx. 5 seconds
Above 150% ¹⁾ of set value	Current limiting to approx. 150% ¹⁾ for typ. 100 ms, then shutdown
Above set value with simultaneous collapse of supply voltage below 20 V DC	Immediate shutdown

Startup characteristics: Load ramp-up to 150% of set value with stable voltage supply of at least 20 V

¹⁾ SITOP PSE200U versions with NEC Class 2: 110%

SITOP SEL1200 – switching characteristic for standard protection

The SEL1200 selectivity modules also allow higher, brief overload currents. The higher the current, the faster the output is shut down. It is possible that the power supply is loaded for a few milliseconds with a current significantly higher than that which is set. If the power supply unit only has limited overload reserves, it may result in a momentary drop in the 24 V supply. For loads that comply with the PLC standard, however, this is not critical. For standard applications, the SEL1200 selectivity module therefore offers very efficient protection.

For 24 V loads with a high inrush current, the switching characteristic even offers advantages, since whatever applies at shutdown also applies when switching on. High currents are not limited, but can be permitted for a short time. In addition, two neighboring 10 A outputs of the SITOP SEL1200 or SEL1400 selectivity modules can be connected in parallel for a 15 A rated current.

SITOP SEL1200 characteristic: switching

Shutdown response: The higher the current, the faster the faulty output is shut down, in line with the limit load integral i^2t .

Startup characteristics: Supports loads with high inrush current, whereby the supply voltage can drop to 15 V.

Advantages of all SITOP selectivity modules

- Reliable tripping regardless of cable lengths or cross-sections
- Easy configuration thanks to individual setting of maximum output current using potentiometers
- Remote reset possible from a central location
- Three-color LEDs for fast on-site fault localization
- Two possibilities for remote diagnostics: common signaling contact or single-channel signaling
- Single-channel evaluation via just one PLC digital input and function block
- Simple commissioning thanks to manual switch on/off of load circuits using reset button
- Sequential connection delay of individual 24 V DC load circuits reduces total inrush current
- Sealable transparent cover protects against maladjustment of tripping currents and sequential delay

Special features of the SITOP SEL1200/SEL1400

- SITOP SEL1200: Switching characteristic for standard requirements compliant with PLC standard
- SITOP SEL1400: Limiting characteristic for highest demands on the 24 V protection
- Four or eight load circuits per module, with adjustable output current range of 1 ... 5 A or 2 ... 10 A
- Two neighboring outputs, switchable in parallel (for up to 50% higher current, e.g. 15 A with two 10 A outputs)
- Slim design matching that of the SITOP PSU6200
- Single-channel diagnostics via free SIMATIC S7 blocks with extensive evaluations per output: Actual current, current threshold, reason of the shutdown, etc.
- Push-in terminals

Special features of the SITOP PSE200U

- Limiting characteristic for highest demands on the 24 V protection
- Four load circuits per module, with adjustable output current range of 0.5 ... 3 A or 3 ... 10 A
- Versions with power limitation of the outputs to 100 VA according to NEC Class 2
- Stepped design corresponding to low-voltage switchgear, e.g. miniature circuit breakers
- Evaluation of individual channels via free of charge SIMATIC S7 or SIMOTION function blocks or LOGO! software
- Library for visualization in SIMATIC PCS 7
- Voltage measuring points for output currents
- Screw terminals

SITOP selectivity modules – all connections, functions and options at a glance

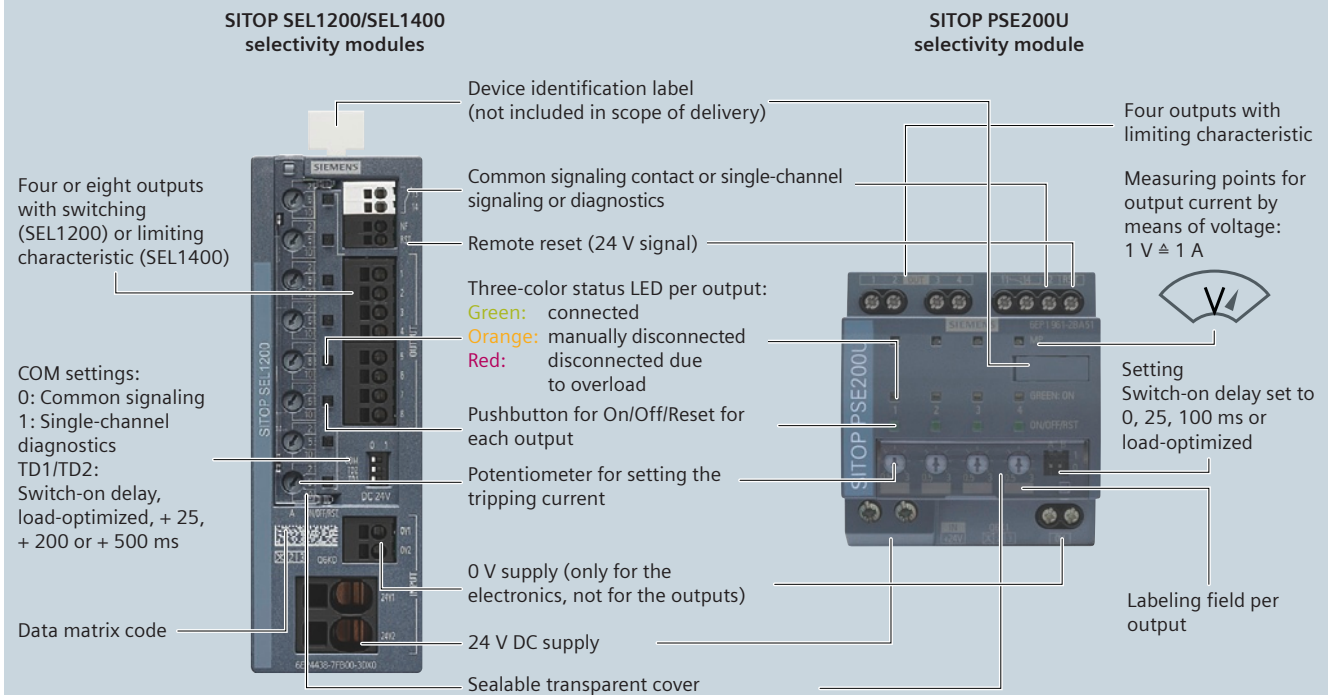

Sequential switching on reduces burden on the power supply

By switching on the outputs sequentially, the inrush current that the power supply has to provide is considerably reduced. This avoids the danger of a voltage dip which could result in disturbances within the plant. A power supply with a lower rated output current can possibly also be used. The "load-optimized" setting means that the next output is not connected until the previous output current is below the set value. This is a standard response for SITOP SEL, with cumulative delay time; for PSE200U it can be set as an option.

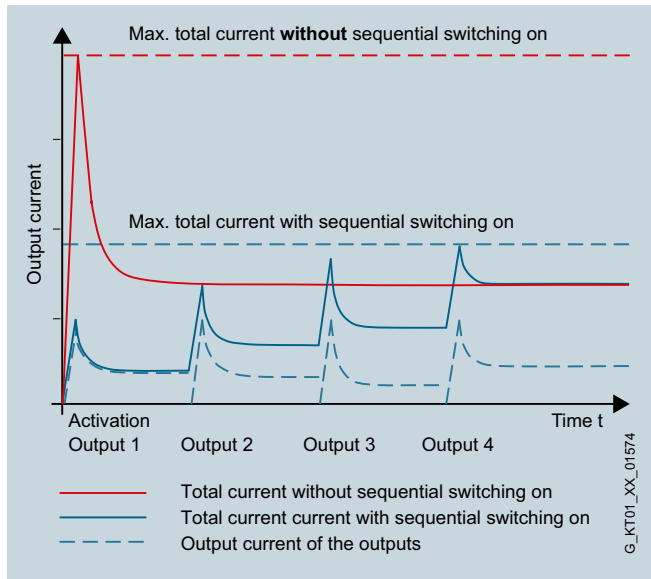

SITOP PSE200U: Current measurement with voltmeter

The SITOP PSE200U selectivity module has a measuring point (MP) for each output, via which the current value at any moment is output. Because one volt corresponds to one ampere, simple voltage measurement is possible for determining the current without having to disconnect the cable. The 24 V supply to the load circuit is not interrupted and the plant remains fully operational.



Fast, channel-exact diagnostics

The single-channel signaling of the PSE200U and the single-channel diagnostics of the SEL1200/1400 are efficient status signals to the PLC via only one digital input. A serial code is evaluated via a free-of-charge SIMATIC S7 function block. SITOP PSU200U reports the status of the outputs via 4 channel bits, each of which are separated by a pause bit:

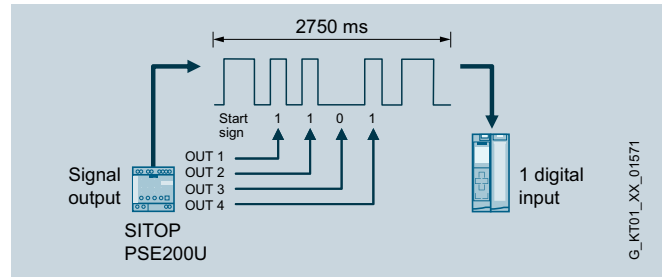

In addition, SITOP SEL1200 and SEL1400 offer extensive evaluation options:





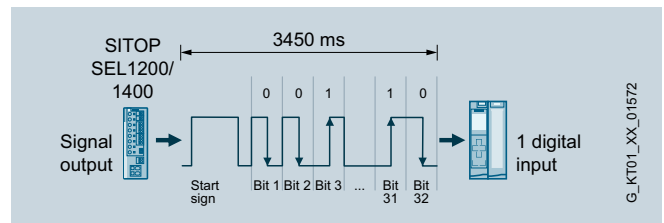

- Output current from each of the 4 or 8 outputs
- Set current threshold
- Reason for automatic disconnection:
 - Overload up to 150% for more than 5 s
 - Overload in excess of 150% total current (> 63 A, > 30 s)
 - Overcurrent ($I > I$ setting) and undervoltage (< 20 V)
 - Input voltage too low (< 15 V) / too high (> 30 V)
 - Overtemperature
- SITOP SEL type: manufacturing date, article number



The values are encrypted in a telegram with 32 bits that are transmitted as Manchester code:



By means of WinCC faceplates the states and values of each output of the SITOP SEL1200 or SEL1400 can be easily visualized:

SITOP SEL1400							
State	Outputs	Information	Trends				
No. 1	Limit	5 A	Output	3 A	Position	COM	<input checked="" type="checkbox"/>
2	Output	2 A	Current:	0 A	DIP switches:	TD1	<input checked="" type="checkbox"/>
3	Current:	2 A		0 A		TD2	<input checked="" type="checkbox"/>
4		9 A		0 A	Startup sequence:		
5		7 A		0 A	Load-dependent startup		
6		10 A		0 A	Outputs: <input type="button" value="RESET"/>		
7		10 A		0 A			
8		10 A		0 A			

Technical specifications	new	new		new	new	
						
	SITOP SEL1200			SITOP SEL1400		
Article number	6EP4437-7FB00-3CX0	6EP4437-7FB00-3DX0	6EP4438-7FB00-3DX0	6EP4437-7EB00-3CX0	6EP4437-7EB00-3DX0	6EP4438-7EB00-3DX0
Input						
Rated voltage $V_{in \text{ rated}}$	24 V DC					
Voltage range	20.4 ... 30 V DC					
Input current	Max. 63 A					
Output						
Rated voltage $V_{out \text{ rated}}$	Typ. $U_e - 0.2 \text{ V}$					
Number of outputs	4	8	8	4	8	8
Rated current $I_{out \text{ rated}}$ up to +60 °C per output	10 A	5 A	10 A	10 A	5 A	10 A
Setting range per output	2 ... 10 A	1 ... 5 A	2 ... 10 A	2 ... 10 A	1 ... 5 A	2 ... 10 A
Tripping characteristic	Switching – for standard protection devices			Current-limiting – for increased requirements regarding protection		
Set time delay	Load-optimized (as soon as the previous output is less than the set rated value again), +25 ms, +200 ms, +500 ms					
Efficiency at $V_{out \text{ rated}} / I_{out \text{ rated}}$	Typ. 98%					
Protection and monitoring						
Status displays	Three-color LED per output: green – connected, yellow – manually disconnected, red – disconnected due to overload					
Signal output	Diagnostics interface for common signaling or single-channel diagnostics. Evaluation of the single-channel diagnostics via SIMATIC S7 function block					
Diagnostics	Common signaling: Disconnection of at least one output Single-channel diagnostics: Current, set current threshold, status (on/off), where applicable, reason for disconnection per output					
Protection class	Class III					
Degree of protection (EN 60 529)	IP20					
Certifications	CE, UL, cURus, CB, cCSAus, CSA, ATEX, IECEx, in preparation: Class I Div 2, DNV GL and ABS					
Connections						
Input +24 V (load and electronics supply)	2 Push-in for 0.5 ... 16 mm ²					
Input 0 V (electronics supply)	2 Push-in for 0.5 ... 4 mm ²					
Outputs 1 to 4	4 Push-in for 0.5 ... 4 mm ²	8 Push-in for 0.5 ... 4 mm ²	8 Push-in for 0.5 ... 4 mm ²	4 Push-in for 0.5 ... 4 mm ²	8 Push-in for 0.5 ... 4 mm ²	8 Push-in for 0.5 ... 4 mm ²
Signal output	2 Push-in for 0.5 ... 1.5 mm ²					
Remote reset	1 Push-in for 0.5 ... 1.5 mm ²					
General data						
Emitted interference	EN 61000-6-3, EN 55022 Class B					
Noise immunity	EN 61000-6-2					
Ambient temperature range	–25 ... +70 °C (–25 ... +85 °C transport/storage)					
Mounting	DIN rail EN 60715 35 x 7.5/15					
Dimensions (width x height x depth) in mm	45 x 135 x 125					
Weight approx.	0.3 kg					
Accessories	Reference identification labels 15 mm x 10 mm, 160 units, article number: 6ES7193-6LF30-0AW0					

Technical specifications				
				
	SITOP PSE200U with common signaling contact		SITOP PSE200U with single-channel signaling	
Article number ... with NEC Class 2	6EP1961-2BA11 6EP1961-2BA51	6EP1961-2BA21	6EP1961-2BA31 6EP1961-2BA61	6EP1961-2BA41
Input				
Rated voltage $V_{in rated}$	24 V DC			
Voltage range	22 ... 30 V DC			
Input current	Max. 40 A			
Output				
Rated voltage $V_{out rated}$	Typ. $U_{in} - 0.2$ V			
Number of outputs	4	4	4	4
Rated current $I_{out rated}$ up to +60 °C per output	3 A	10 A	3 A	10 A
Setting range per output	0.5 ... 3 A	3 ... 10 A	0.5 ... 3 A	3 ... 10 A
Tripping characteristic	Current-limiting – for increased requirements regarding protection			
Set time delay	0 ms, 25 ms or 100 ms (identical between outputs) or load-optimized (as soon as the previous output is less than the set rated value)			
Efficiency at $V_{out rated}$ / $I_{out rated}$	97%	99%	97%	99%
Protection and monitoring				
Status displays	Three-color LED per output: green for output connected, yellow for output manually disconnected, red for output disconnected due to overload/short-circuit			
Signal output	Common signaling contact, changeover contact, contact rating 24 V/0.5 A		Single-channel signaling: cyclic signaling for channel-specific evaluation using SIMATIC S7 function block	
Diagnostics	Disconnection of at least one output. The current per output can be measured via voltage measuring points (1 V \pm 1 A)		Status (on/off) of each of the 4 outputs. The current per output can be measured via voltage measuring points (1 V \pm 1 A)	
Protection class	Class III			
Degree of protection (EN 60 529)	IP20			
Certifications	UR (UL 2367), cURus (UL 508, CSA C22.2 No. 107.1), cCSAus (Class I Div 2), ATEX, IECEx, DNV GL, ABS, 6EP1961-2BA51/6EP1961-2BA61: NEC Class 2			
Connections				
Input +24 V (load and electronics supply)	2 screw terminals for 0.5 ... 10 mm ²			
Input 0 V (electronics supply)	2 screw terminals for 0.5 ... 4 mm ²			
Outputs 1 to 4	1 screw terminal each for 0.5 ... 4 mm ²			
Signal output	3 screw terminals for 0.5 ... 4 mm ²		1 screw terminal for 0.5 ... 4 mm ²	
Remote reset	1 screw terminal for 0.5 ... 4 mm ²			
General data				
Emitted interference	EN 61000-6-3, EN 55022 Class B			
Noise immunity	EN 61000-6-2			
Ambient temperature range	–25 ... +60 °C (–25 ... +85 °C transport/storage)			
Mounting	DIN rail EN 60715 35 x 7.5/15			
Dimensions (width x height x depth) in mm	72 x 80 x 72			
Weight approx.	0.2 kg			
Accessories	Device identification label 20 mm x 7 mm, 340 units, article number: 3RT1900-1SB20			

Get more information

More on the SITOP selectivity modules:

www.siemens.com/sitop-select

Using the TIA Selection Tool to select the appropriate power supply, including add-on module:

www.siemens.com/tia-selection-tool

Operating instructions as download:

www.siemens.com/sitop/manuals

CAX data (2D, 3D, circuit diagram macro) as download:

www.siemens.com/sitop-cax

Find your personal contact partners at:

www.siemens.com/automation/partner

Published by Siemens AG

Digital Industries
Process Automation
Östliche Rheinbrückenstr. 50
76187 Karlsruhe, Germany

For the U.S. published by Siemens Industry Inc.

100 Technology Drive
Alpharetta, GA 30005
United States

Article No. 6ZB5341-0AH02-0BA7

Dispo 10001

BR 0420 0.75 TVS 8 En

Produced in Germany

© Siemens 2020

Subject to changes and errors.

The information given in this catalog only contains general descriptions and/or performance features which may not always specifically reflect those described, or which may undergo modification in the course of further development of the products.

The requested performance features are binding only when they are expressly agreed upon in the concluded contract.

All product designations may be trademarks or product names of Siemens AG or other companies whose use by third parties for their own purposes could violate the rights of the owners.

Security information

Siemens provides products and solutions with industrial security functions that support the secure operation of plants, systems, machines and networks.

In order to protect plants, systems, machines and networks against cyber threats, it is necessary to implement – and continuously maintain – a holistic, state-of-the-art industrial security concept. Siemens' products and solutions constitute one element of such a concept.

Customers are responsible for preventing unauthorized access to their plants, systems, machines and networks. Such systems, machines and components should only be connected to an enterprise network or the internet if and to the extent such a connection is necessary and only when appropriate security measures (e.g. firewalls and/or network segmentation) are in place.

For additional information on industrial security measures that may be implemented, please visit

<https://www.siemens.com/industrialsecurity>

Siemens' products and solutions undergo continuous development to make them more secure. Siemens strongly recommends that product updates are applied as soon as they are available and that the latest product versions are used. Use of product versions that are no longer supported, and failure to apply the latest updates may increase customer's exposure to cyber threats.

To stay informed about product updates, subscribe to the Siemens Industrial Security RSS Feed under

<https://www.siemens.com/industrialsecurity>