

FIBERPLEX SECURE COMMUNICATIONS

Transforming Communication Infrastructure Through Fiber

FiberPlex™ Connectivity Product Guide



Industrial Communication Products Ltd
Tel: +44 (0) 203 086 9569

Web: www.industrialcomms.co.uk
E-mail: sales@industrialcomms.com

In this Guide

Ethernet over Fiber
Fiber Optic Isolator
Fiber Converter
Fiber Modem
Fiber Line Driver

Fiber Multiplexer
WDM (Wave Division Multiplexer)
SFP (Small Form Pluggable) Transceiver
Media Converter
Fiber Transmitter Receiver



Contents

FiberPlex™ Transforming Communication Infrastructure Through Fiber	.3	Product Style FOM	.22
FiberPlex™ Why Fiber? Infographic	.4	FOM Cards	.22
FiberPlex™ Applications Infographic	.6	FOM Standalone Enclosure	.22
FiberPlex Product Functions	.8	FOM Rackable Chassis	.23
Copper-to-Fiber Isolator / Converter / Modem	.8	Product Style TD	.24
Isolator—Engineered Isolation	.8	TD (Throw-Down) Series	.24
1. Bit Cleaning	.8	TD NEMA Enclosures	.25
2. Data Diode Systems	.9	TD 6-Position Truss Mount	.26
Converter—Smart Conversion	.10	TD Kits	.27
Converter—Serial Conversion over Fiber	.11	TD DIN Rail Mounting Bracket	.27
Modem—Transparent “Modems”	.11	TD 6-Position Front-Connect Rack Chassis	.28
Fiber-to-Fiber Mode Conversion	.12	TD 6-Position Rear-Connect Rack Chassis	.29
Wavelengths & Modes	.12	Products by Interface Type	.30
Protocol & Rate Independent Transparency	.12	Products by Category	.32
Fiber Repeaters	.12	Major Market Segments	.34
Fiber Wave Division Multiplexing	.14	Defense & Intelligence	.34
Fiber Waveguide Feedthrough Filters	.16	Civilian Government Agencies	.34
Product Line Overview	.18	System Integration	.35
Product Style FOI	.18	Energy & Transportation	.35
FOI (Fiber Optic Isolator)	.18	Broadcast & Production	.36
FOI NEMA Enclosures	.19	Manufacturing & Industrial	.36
2U FOI Rackable Chassis	.20	FiberPlex Products	.37–56
3U FOI Rackable Chassis	.21		
FOI Wall Mount Adapter	.21		

Copyright and Trademark Statement

Copyright © 2018 Patton Electronics Co. All rights reserved.

Patton is a registered trademark of Patton Electronics Company in the United States and other countries. The terms *LightViper* and *FiberPlex* are trademarks licensed to Patton Electronics Company.

FiberPlex™ Transforming Communication Infrastructure Through Fiber



The FiberPlex brand was established by the earliest founders of fiber optics who had a vision to transform communications. That vision has manifested and grown to reality through Patton’s new FiberPlex portfolio. Together and with our ecosystem partners, we are transforming communications every single day and across the world through fiber optics. Over these decades we have adapted the FiberPlex core technologies to the digital communication needs of our customers and deliver the solutions in a constantly evolving landscape.

We hope this guide is a helpful tool and empowers you to explore the value of fiber and the FiberPlex products.

Why Fiber?: The 8 Pillars

Of Secure, Quality, Digital Communications Infrastructure

SECURITY	DISTANCE	BANDWIDTH	IMMUNITY	ISOLATION	COST	SUSTAINABILITY	TRANSPARENCY
<p>How secure is your physical communications infrastructure?</p> <p>CAT 5/6/7 Can be "tapped" without physically connecting to the cable</p>	<p>How far does data go without using a repeater?</p> <p>CAT 5/6/7 100 meters</p>	<p>What is the speed of transmitting data from end to end?</p> <p>CAT 6c 1 Gbps up to 100 meters</p> <p>CAT 7 10 Gbps up to 100 meters</p>	<p>How susceptible is the network to radiated emissions?</p> <p>CAT 5/6/7 Susceptible to EMI/RFI</p>	<p>How separated are the electronics from high voltages, noise, and ground loops?</p> <p>CAT 5/6/7 Subject to ground loop and damages from lightning and overvoltages</p>	<p>What is the cost of ownership counting size, weight, & lifespan of copper?</p> <p>CAT 5/6/7 Weight/1000 ft: 39 lbs. Energy/User: 10 watts Lifecycle: 5 years</p>	<p>How GREEN is your network infrastructure?</p> <p>CAT 5/6/7 Made from copper</p>	<p>How involved is the equipment with protocols, handshaking, and signaling?</p> <p>CAT 5/6/7 Typical transport schemes receive and re-transmit data in a way that can limit their scope of use.</p>
<p>Fiber Very difficult to tap and does not produce compromising emanations</p>	<p>Fiber 120,000 meters</p>	<p>Fiber 1 Pbps (petabit) up to 50 km 1 petabit = 1000 terabits</p>	<p>Fiber Immune from EMI/RFI (Radio Waves & Crosstalk)</p>	<p>Fiber Totally electrically isolated and not a conductor of electrical voltages</p>	<p>Fiber Weight/1000 ft: 4 lbs. Energy/Users: 2 watts Lifecycle: 50 years</p>	<p>Fiber Made from glass fiber</p>	<p>Fiber With our unique approach, the connection is completely transparent. Think "layer 0".</p>
<p>Did you know? Some fiber is so thin it is barely wider than a strand of hair.</p>	<p>Did you know? A team of researchers have sent 255 terabytes per second over a single fiber. That is nearly equal to peak internet traffic in 2016. A typical computer has local storage of 255 gigabytes.</p>	<p>Did you know? CAT 6 and 7 cables need to be installed at least 3 feet from magnetic fields. That's why installers keep cable runs far away from fluorescent lights, power lines, and other stuff.</p>	<p>Did you know? Fiber is the primary communications infrastructure used at power generation facilities, and it often runs alongside high voltage power lines.</p>	<p>Did you know? Over 10 years, we've had 5 new copper cable standards. Average cable width, including protective covering, is about 8 mm for CAT 5/6/7, while fiber cable is only 3 mm.</p>	<p>Did you know? Fiber is made from the plentiful resources of silica and sand, while copper mines are depleting resources and causing environmental impacts.</p>		

Alarms & Announcements 

Digital Signage 

Secure Facilities 

Video Surveillance 

Live Production & Broadcast 

Telephony Endpoints 

Telecom Backhaul 

Telemetry 

Campus/Distance Learning 

Traffic/Transport Signaling 

Petrochemical Production 

Smart Building HVAC 

Serial Datacom
Asynchronous and Synchronous Communications Interfaces

Telecom
Analog and Digital Telephone & Network Interfaces

Video
Analog, Standard Definition and High Definition Video Interfaces

Audio
Mic Level, Line Level, Digital & Multi-Channel Pro Audio Interfaces

IT, Ethernet & Networking
Ethernet Interfaces from 10 Mbps to 10 Gbps

SCADA, Alarm, Relay, Control, & Notification
Contact Closure, Actuation and Sensor Control Interfaces

TIA/RS-232; TIA/RS-422/485/530; CCITT V.35/X.21; MIL-STD-188-114A

Analog POTS (FXS/FXO); Nortel Meridian M2000 & M3000; Avaya 2400 & 9400 Series; ISDN S/T; E&M; T1, T3; E1, E3; STS-1

Analog Composite; SD-SDI; 3G-SDI; HDMI 1.4

Analog Mic Level; Analog Line Level; 2-Wire Analog; AES3; AES10 (MADI); AVB; DANTE

10/100Base-T; 10/100/1000 Base-T; 100Base-FX, SX, BX10, LX10; 1000Base-SX, BX10, LX10, ZX; 10G Ethernet

Contact Closure (Form A & C); Voltage Actuation; Shorting Contact; Analog Sensors



FiberPlex Product Functions

Copper-to-Fiber Isolator / Converter / Modem

Isolator—Engineered Isolation

We have summarized the protective features of fiber isolation in our 8 Pillars Info graphic. The use of this feature is optimized in a FiberPlex product.

Specially designed to suppress compromising emanations, we deliver separation between BLACK and RED communications environments using TEMPEST tested and approved products. Isolation is at the core of secure digital communication helping to prevent the possibility of classified or secure information from being transmitted or exposed to the outside world.

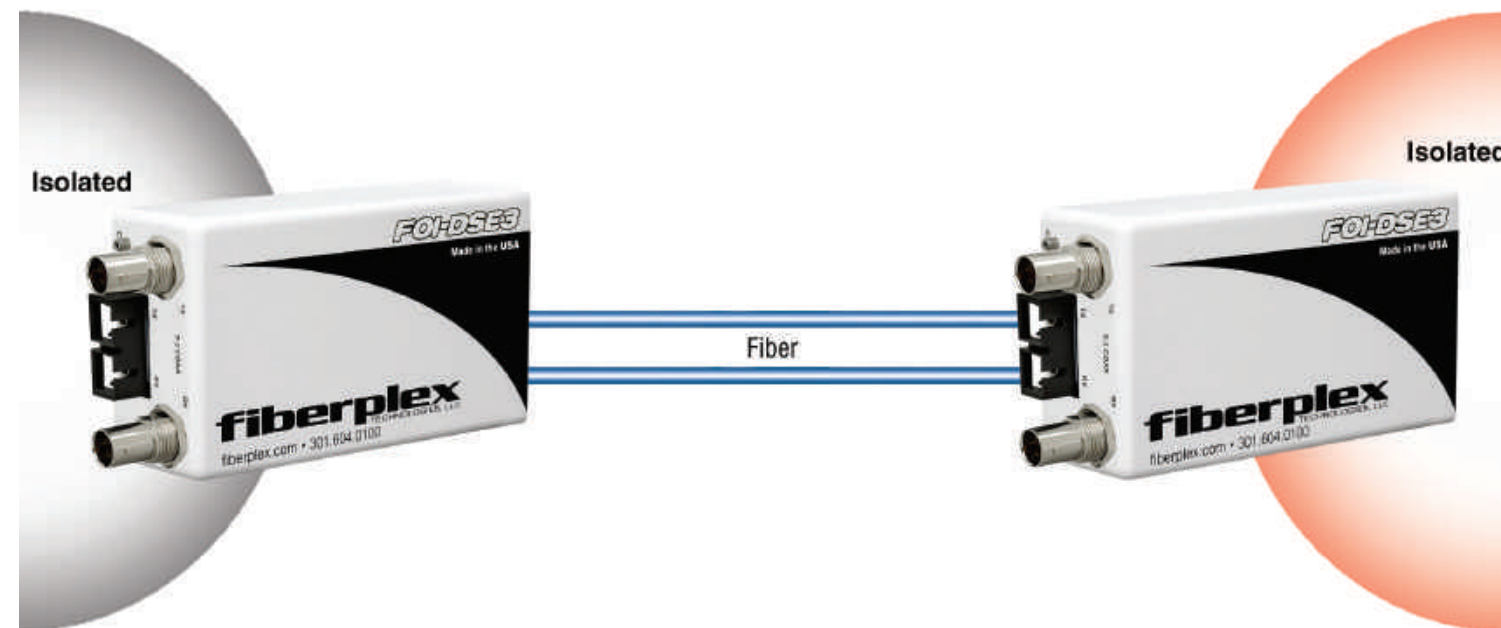

1. Bit Cleaning

Compromising emanations (CE) can contain sensitive information radiated in the air and coupled into existing wiring and electronic equipment superimposed on to digital data transmissions. On the unsecure side of a network segment, these emanations can be extracted from the data and reconstructed creating a serious security breach. TEMPEST is a certification developed by NSA and NATO to address these problems. FiberPlex products “clean” the digital data of any emanations and restore it to its pure form before it leaves the sensitive area. FiberPlex manufactures TEMPEST certified equipment which employ fiber.

2. Data Diode Systems

In defense and intelligence applications, systems are designed to create separation between networks of differing security classifications. Data diodes separate and create boundaries between trusted and untrusted networks and straddle the demarcation line between them. This separation between networks is also referred to as “network segmentation”.

In this scenario, data traffic is transmitted in only one direction. Traffic such as UDP unicast, video streaming, unclassified weather data, file transfers are common uses for data diodes. Many FiberPlex products can operate in transmit-only data-diode configuration and are frequently used in Data Diode systems.

Get the white paper [“The Frequently Overlooked Hole in Your Cyber Security Platform”](#)

Protection Against Compromising Emanations (CE) Leakage



IIoT Protection

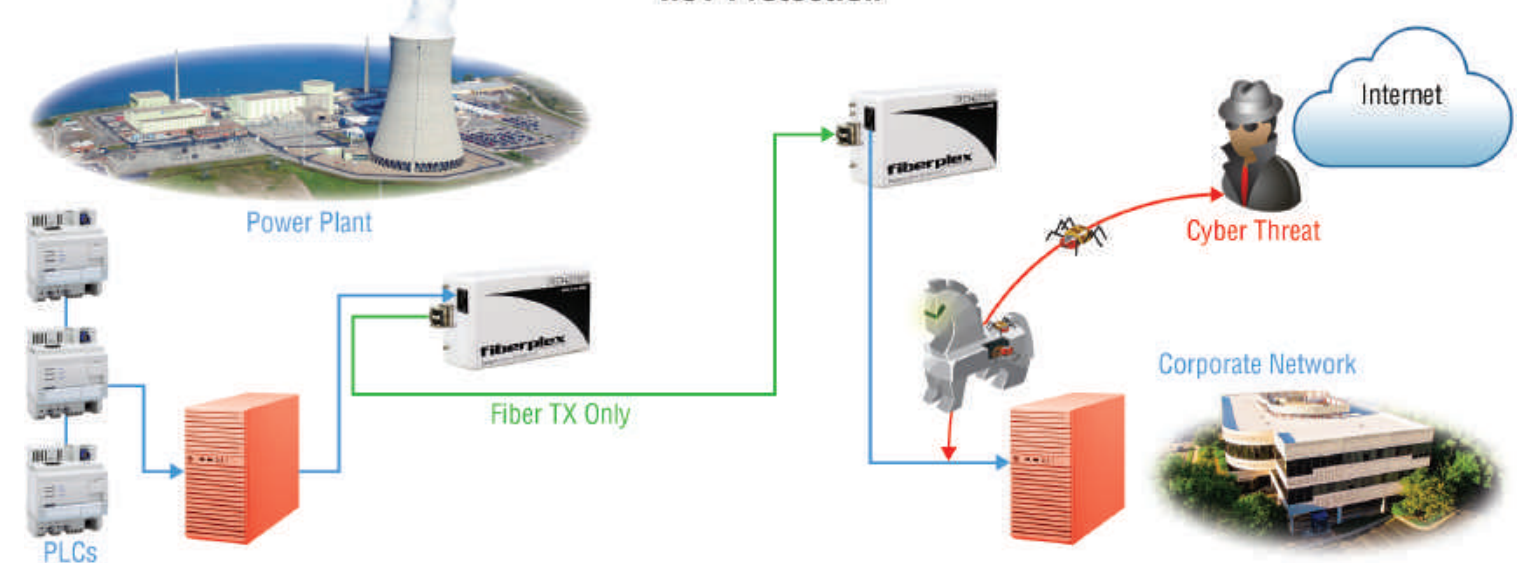

FiberPlex Product Functions

Copper-to-Fiber Isolator / Converter / Modem

Converter—Smart Conversion

The concept of a converter is pretty simple. This side is a copper wire ↔ that side is a glass fiber. But, Patton performs “use-case” conversions for common installation needs across a range of vertical markets. This involves things like an audio channel together with an RS-232 interface and a contact closure, commonly need together for annunciator systems.

Railroad Signaling Application



Audio Tie Lines + Control Application



Intercom / Loop Application



Converter—Serial Conversion over Fiber

FOI units can be used to convert asynchronous or synchronous serial interfaces across an isolated and/or extended fiber link. The table below shows the conversion possibilities and the related models.

FOI Conversion Table					
From	↔	To	128 kbps Models	1 Mbps Models	6 Mbps Models
RS-232 (DCE)		RS-232 (DTE)	FOI-2191 FOI-2911	FOI-4141 FOI-4411	
RS-232 (DCE)		RS-232 (DCE)	FOI-2191 FOI-2191	FOI-4141 FOI-4141	
RS-232 (DCE)		RS-422/RS-530 (DTE)	FOI-2191 FOI-2951	FOI-4141 FOI-4541	
RS-232 (DCE)		V.35 (DTE)		FOI-4141 FOI-4431	
RS-422/RS-530 (DCE)		RS-422/530 (DTE)	FOI-2591 FOI-2951		FOI-4451 FOI-4541
RS-422/RS-530 (DCE)		RS-422/530 (DCE)	FOI-2591 FOI-2591		FOI-4451 FOI-4451
RS-422/RS-530 (DCE)		RS-232 (DTE)	FOI-2591 FOI-2911	FOI-4451 FOI-4411	
RS-422/RS-530 (DCE)		V.35 (DTE)			FOI-4451 FOI-4431
V.35 (DCE)		V.35 (DTE)			FOI-4341 FOI-4431
V.35 (DCE)		V.35 (DCE)			FOI-4341 FOI-4341
V.35 (DCE)		RS-232 (DTE)		FOI-4341 FOI-4411	
V.35 (DCE)		RS-422/RS-530 (DTE)			FOI-4341 FOI-4541

Modem—Transparent “Modems”

Some people call these modems, because they send and receive electronic signals over fiber, and then convert them back allowing for full duplex transmission. FiberPlex products are different. Although in some cases we are performing data and clock buffering we are otherwise completely transparent to protocols, handshaking and signaling.

And... You choose the optics, for the distances you need.

FiberPlex Product Functions

Fiber-to-Fiber Mode Conversion

Wavelengths & Modes

Fiber-to-fiber converters enable the extension of multimode to singlemode or multimode to multimode fiber connections. Many early fiber installs were done with multimode fiber. The standard in modern communication has moved singlemode due to its higher bandwidth and longer distance capabilities. If you already have an inventory of fiber equipment with multimode optics or have multimode fiber in the ground, this can present a problem. FiberPlex products perform mode conversion which includes conversion from multimode to singlemode or from one wavelength to another.



Protocol & Rate Independent Transparency

These are SFP-to-SFP protocol-independent media converters enabling interoperability of multiple fiber types and wavelengths in, or between, networks. Protocol independent means these model converters can be use all network protocols and leveraged in LAN, WAN, Ethernet, ATM, Gigabit Ethernet, ISDN E1/T1, Sonet/SDH as well as various audio and video applications. Numerous fiber to fiber mode conversion applications are possible and all result in savings compared to replacing infrastructure or optical blades on network equipment. Rate-transparency enables support for SFP transceivers with data rates up to 3 Gbps.

Read our blog post [“When Your DiGiCo Mixer is Multimode and You Need Singlemode Fiber”](#)

See TKIT-MODE products on page 27.

Fiber Repeaters

A FiberPlex repeater is a fiber-to-fiber unit capable of regenerating the optical signal of any optical device to extend its transmission distance. SFP-to-SFP protocol-transparent fiber-mode repeaters interconnect two fiber connections back-to-back. It repeats, retimes, and regenerates fiber signals to support distances to hundreds of miles.

Like the mode converter function, this solution is protocol independent supporting Ethernet, fiber channel, ATM/SONET OC-X, SDH STM-X, FDDI, and various audio and video use cases.



Patton TKIT-RPTR products are standard bundles for the most common repeater applications. Singlemode and multimode options are available in a selection of speeds. If you have a specific need that is not listed, any of the optical SFPs that we offer can be used ala-carte in a TD-6010. Call us if you need help with your fiber repeater application.

Optical Repeater Kits

- ✓ **TKIT-RPTR-155-M** TD-6010 (1 each) Optical Repeater, Multimode 1310 nm, 155 Mbps, Includes AC Power Adapter
- ✓ **TKIT-RPTR-155-S** TD-6010 (1 each) Optical Repeater, Singlemode 1310 nm, 155 Mbps, Includes AC Power Adapter
- ✓ **TKIT-RPTR-1G-M** TD-6010 (1 each) Optical Repeater, Multimode 1310 nm, 1.25 Gbps, Includes AC Power Adapter
- ✓ **TKIT-RPTR-1G-S** TD-6010 (1 each) Optical Repeater, Singlemode 1310 nm, 1.25 Gbps, Includes AC Power Adapter
- ✓ **TKIT-RPTR-3G-M** TD-6010 (1 each) Optical Repeater, Multimode 1310 nm, 50 Mbps to 3 Gbps, Includes AC Power Adapter
- ✓ **TKIT-RPTR-3G-S** TD-6010 (1 each) Optical Repeater, Singlemode 1310 nm, 50 Mbps to 3 Gbps, Includes AC Power Adapter

Click to download our [“Optical Loss Budget and Performance Margin Calculator”](#)

FiberPlex Product Functions

Fiber Wave Division Multiplexing

Third-Party Connect

Patton's FiberPlex Active WDM can accept direct fiber connection with virtually any third-party digital fiber device by simply inserting a compatible SFP in one of the WDM SFP slots.

Convert & Connect

Utilizing Patton's FiberPlex fiber conversion units, virtually any signal can be multiplexed. Connection to the mux can be achieved via fiber by selecting a matching optical SFP in the WDM or via an inexpensive SFP-to-SFP Triax cable. Patton manufactures conversion devices for the following signal types:

- Serial data (TIA-232, TIS-530, TIA-422, V.35, etc.)
- PSTN (FXO, FXS, ISDN, T1, E1, etc.)
- Audio (Analog, AES3, Dante, etc.)
- Video (3G-SDI, HDMI, SD-SDI, etc.)
- Ethernet
- And more...

Direct Connect

Patton offers a broad selection of FiberPlex SFP modules to allow connection without the need for a media converter including:

- 10/100/1000 Ethernet
- HD-SDI Video
- HDMI
- SD-SDI Video
- Multichannel Audio
- Optical Ethernet (1000Base-TX, 1000Base-SX, etc.)

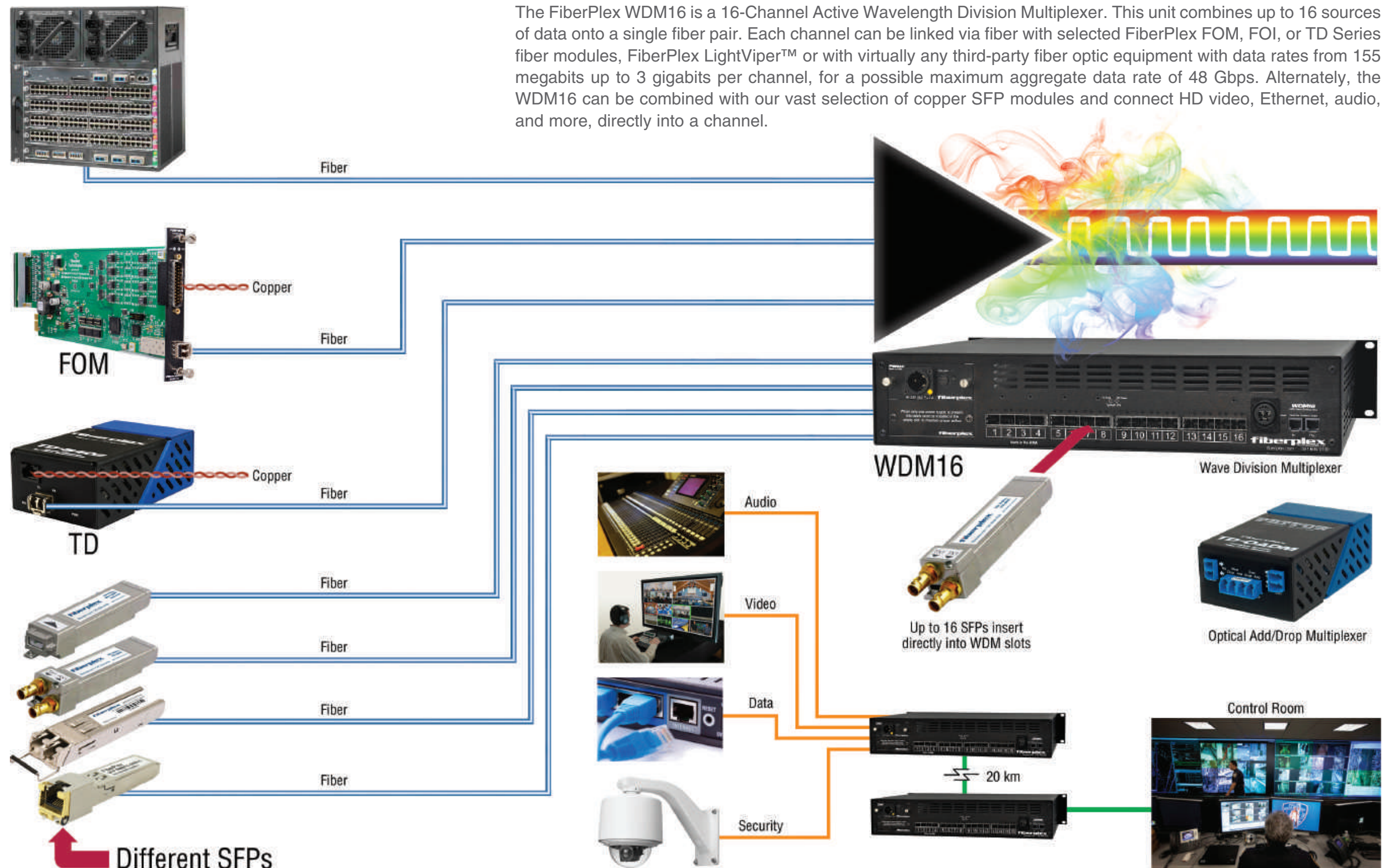

The FiberPlex WDM16 is a 16-Channel Active Wavelength Division Multiplexer. This unit combines up to 16 sources of data onto a single fiber pair. Each channel can be linked via fiber with selected FiberPlex FOM, FOI, or TD Series fiber modules, FiberPlex LightViper™ or with virtually any third-party fiber optic equipment with data rates from 155 megabits up to 3 gigabits per channel, for a possible maximum aggregate data rate of 48 Gbps. Alternately, the WDM16 can be combined with our vast selection of copper SFP modules and connect HD video, Ethernet, audio, and more, directly into a channel.

Fiber Waveguide Feedthrough Filters

Shielded enclosures are used in Defense, Government, and Industry to physically isolate specific electromagnetic interference (EMI) and radio frequency interference (RFI) from the surrounding environment. They can be used to contain EMI/RFI, for example, in an MRI (magnetic resonance imaging) suite or in a SCIF (sensitive compartmentalized information facility) where you want to contain sensitive information. Alternately, they can be used to reject unwanted EMI/RFI in an automotive test facility where they are measuring the RF emissions of an auto and do not want external signals disrupting the test results. Either way, to get information (communications, network, control, monitoring, etc) in and out of the room, the shield wall must be penetrated. This must be very carefully and mathematically done to avoid ruining the shielding characteristic of the room.

To make things more complicated, even if a properly dimensioned hole is put through the shield wall, putting a wire through the hole will act as an antenna and allow a path for unwanted EMI/RFI. Fiber optic cable is inherently a non-conductor so it can be passed through a properly dimensioned hole to pass data. The problem is that a properly dimensioned hole is too small for fiber optic connectors, so the fiber must be passed through unterminated and then field terminated after penetration.

Waveguide feedthroughs are used to create a penetration through a shielded enclosure without violating the shielding characteristics of the enclosure. The FiberPlex brand of waveguide feedthroughs have a patented removable center plug which allows pre-terminated fiber optic cables to be passed through the wall of a shielded enclosure. Once the cable are through, the plug can be reinserted to achieve the desired isolation. The bores in the FiberPlex waveguide feedthroughs are precision milled to allow a specific amount of attenuation at specific frequencies with the plug installed.

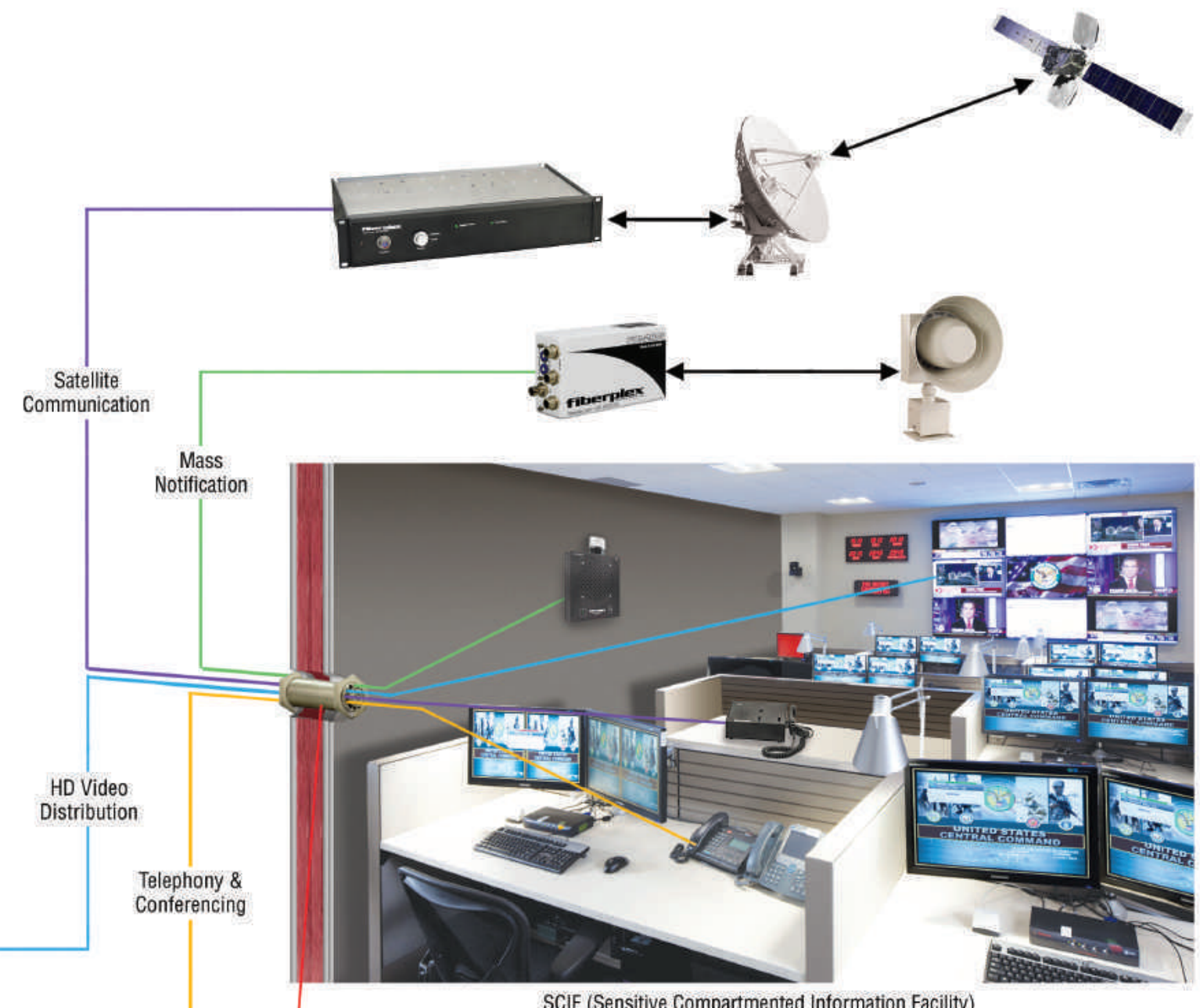
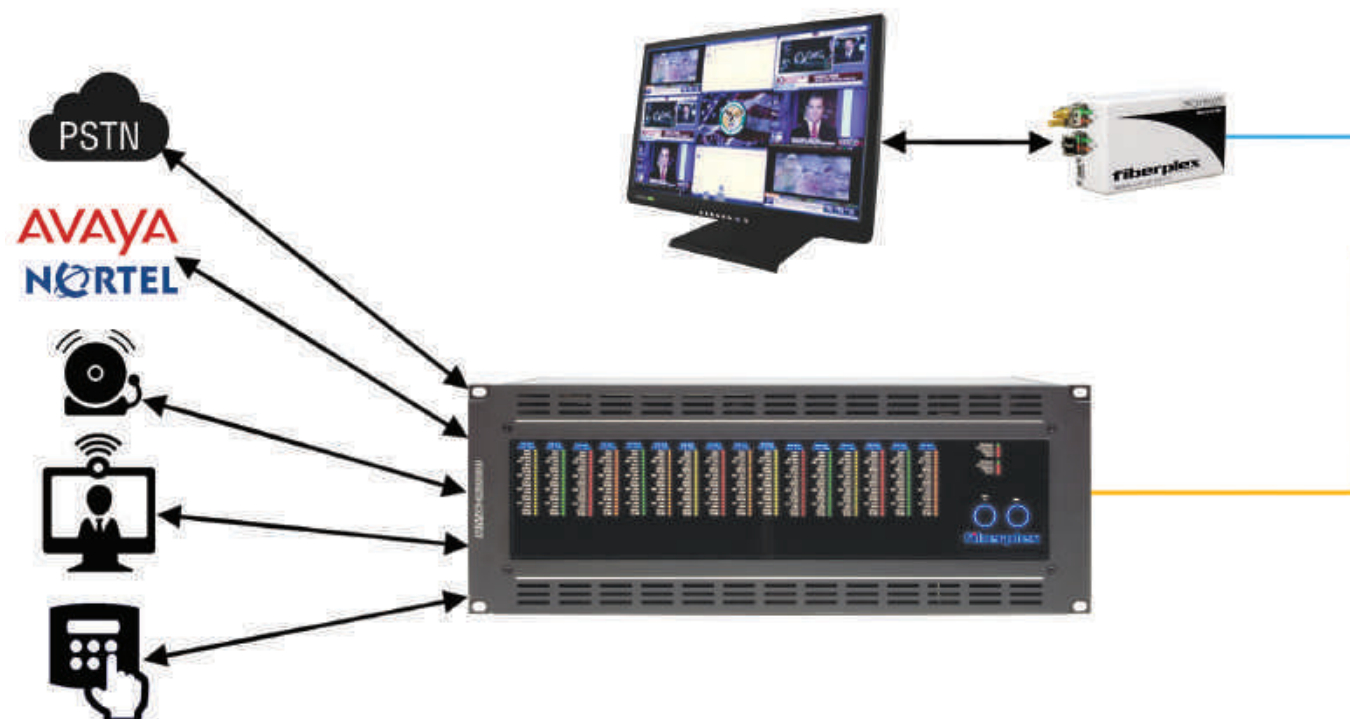

Product Line Overview—Product Style FOI

FOI (Fiber Optic Isolator)

The FOI line of products is designed for ruggedized mission critical applications with attention to RFI shielding and tough steel enclosures.

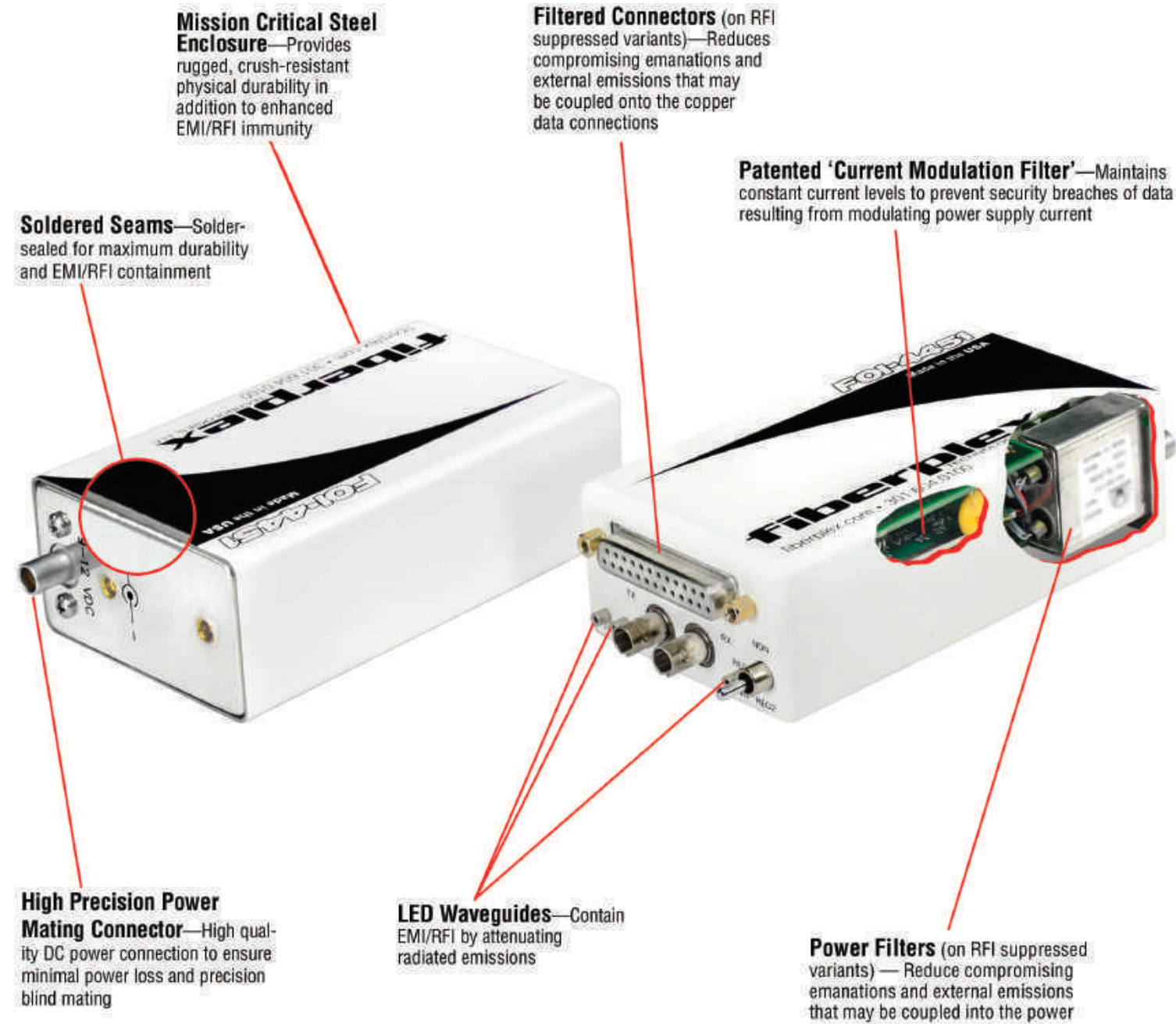

FOI NEMA Enclosures

Heavy duty enclosures designed to survive in indoor and outdoor environments. The chassis is rated to IP-54, protecting the internal components from dust and windblown rain.

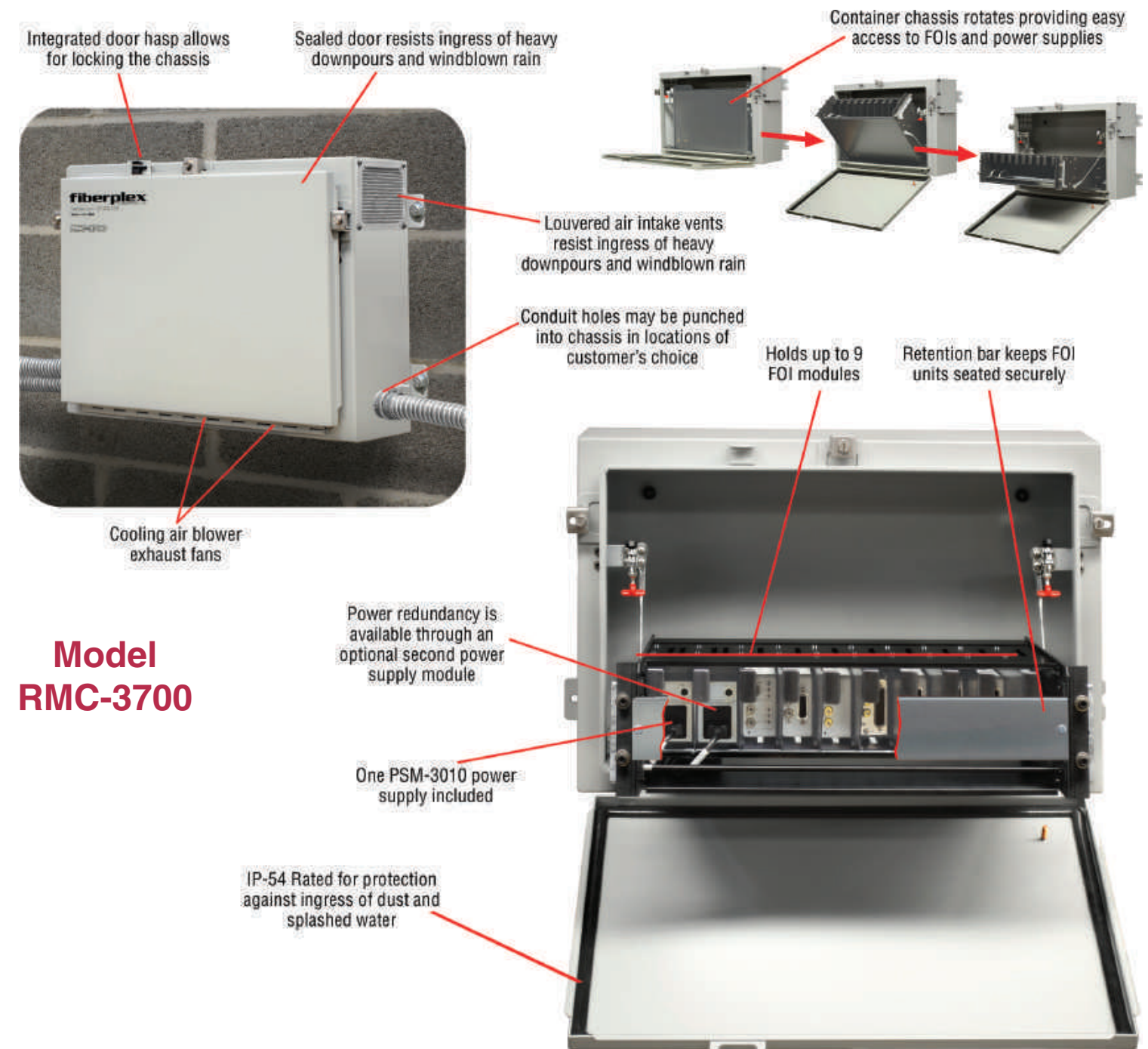

Model RMC-3700

Product Line Overview—Product Style FOI

2U FOI Rackable Chassis

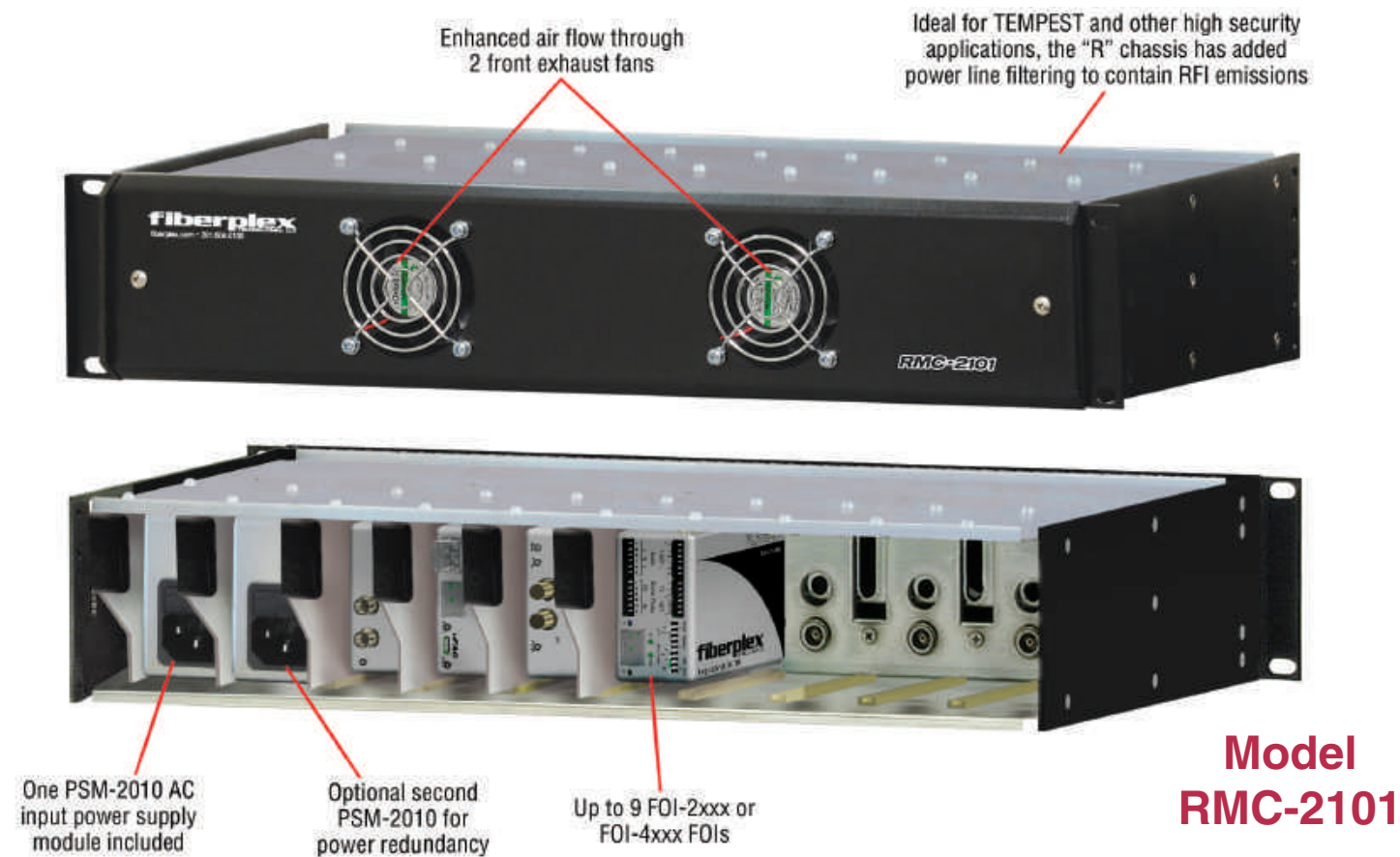

3U FOI Rackable Chassis

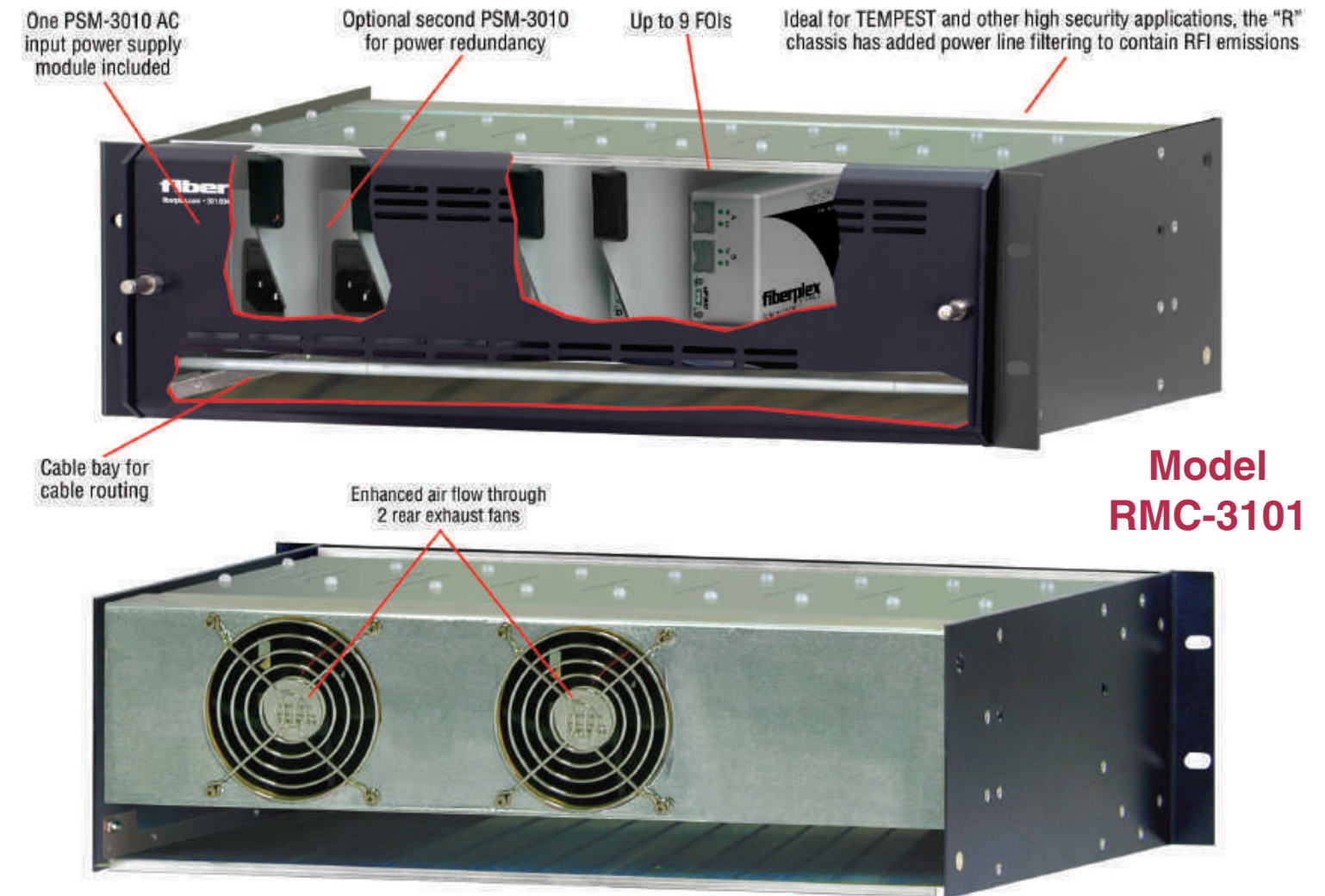

Model RP-2

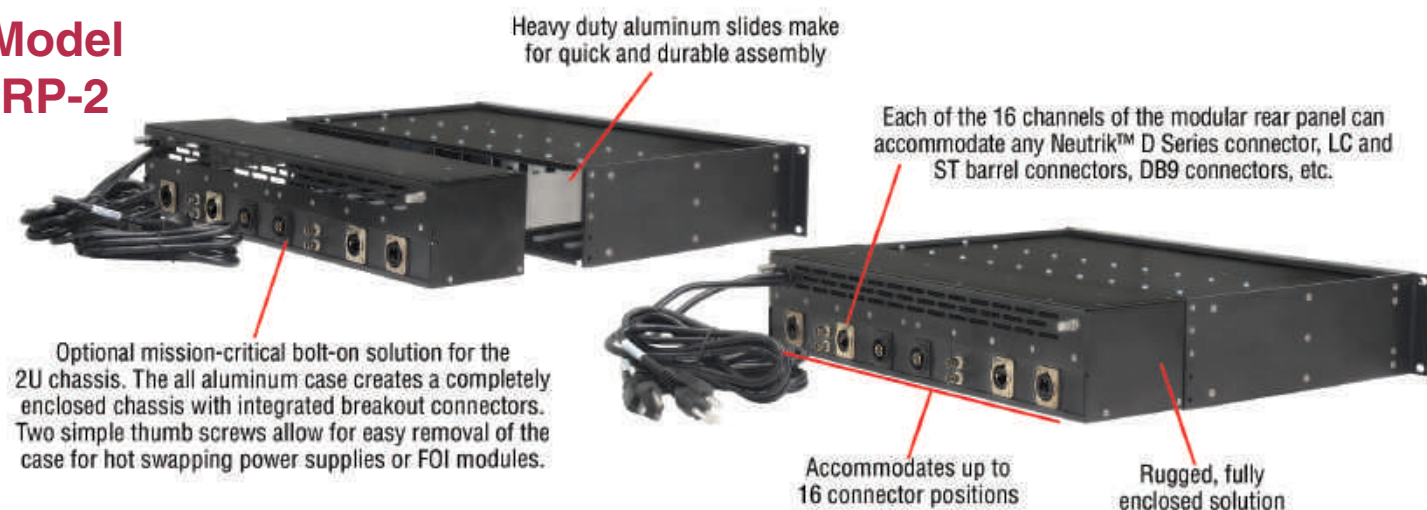

FOI Wall Mount Adapter

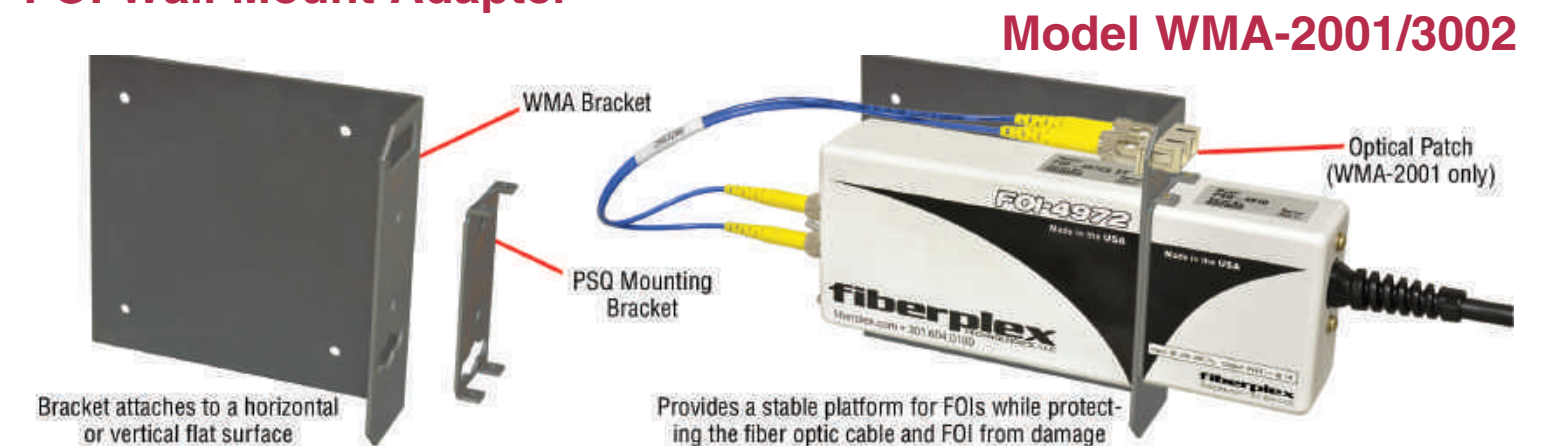

Product Line Overview—Product Style FOM

FOM Cards

The FOM Series provides maximum flexibility and greater channel density in a hot-swappable, card-style module.



FOM Standalone Enclosure

FOM cards are installed in purpose-built enclosures accommodating standalone, wall-mount, and/or side-by-side rack mount installations.

High intensity LEDs show power and fiber optic link status, signal line activity, and control or configuration information, depending on the particular FOM card



Mounts to a desktop, wall, or similar surface

Model SAC-1-AC



Rack mounting in a single installation, occupying 1U of vertical space



Rack mounting in a dual configuration, occupying 1U of vertical space

FOM Rackable Chassis

The FOM rack is available in a standard 4U 19-inch rack mountable chassis accommodating up to 16 FOM module cards

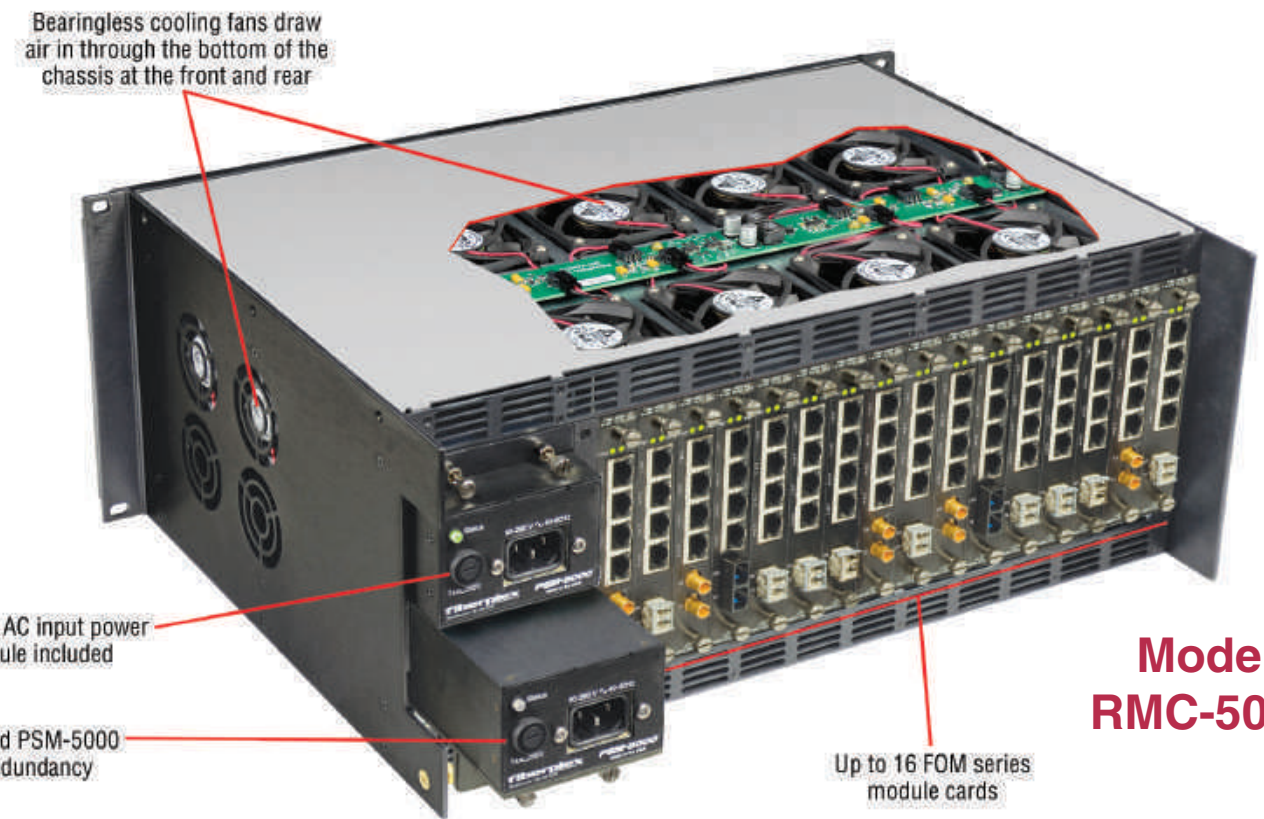

Model RMC-5000

High intensity LEDs show power and fiber optic link status, signal line activity, and control or configuration information, depending on the particular FOM card

Alarm monitor card provides power supply module presence and status, as well as chassis fans, remote communication and module card status



Product Line Overview—Product Style TD

TD (Throw-Down) Series

The TD Series of products have the commercial integrator in mind. TD stands for “throw down” and the units are for standard Commercial installations. They cost less and, unlike the FOI, TD units don’t have the special power supplies and packaging needed in mission critical government applications. The TD units are available for a wide variety of factory made configurations to support a host of applications. The TD-6010 is a “Swiss Army Knife” for fiber optic transport, which can be configured with any SFP/SFP+ optical or electrical modules. Using the flexible SFP approach, you can configure what you want, when you want it, how you want it, wherever you want it; all over one product solution. TKITs are bundled end-to-end kits of TD units.

Integrated Keyhole Mounting—Facilitates easy surface mounting. Also used to attach units to a variety of mounting accessories.

Durable Aluminum Enclosure—Rugged industrial grade, yet lightweight and aesthetically pleasing packaging.

Failsafe Redundant Diode-Combined Power—The wall adapter and Phoenix connections can be powered simultaneously from different sources for failsafe, redundant operation.

Phoenix DC Power Connection—Alternate DC power connection with convenient, easy to terminate Phoenix connector. Also provides positive earth connection.

Wall Adapter Included—Eliminates the need for add-on power supply for standalone applications.



TD NEMA Enclosures

The TD units are available in NEMA rated outdoor enclosures and a variety of different power options, including industrial lighting voltage (277 VAC for example).

Provides mounting and power for up to 3 single-wide TD Series modules, or 1 double-wide module (includes TD and TIS models)

TD Modules not included

NEMA 4x Rated Watertight and corrosion resistant

Enclosure is ready to be punched to accommodate your connectivity needs (environmentally sealed conduit connectors must be used to maintain seal)

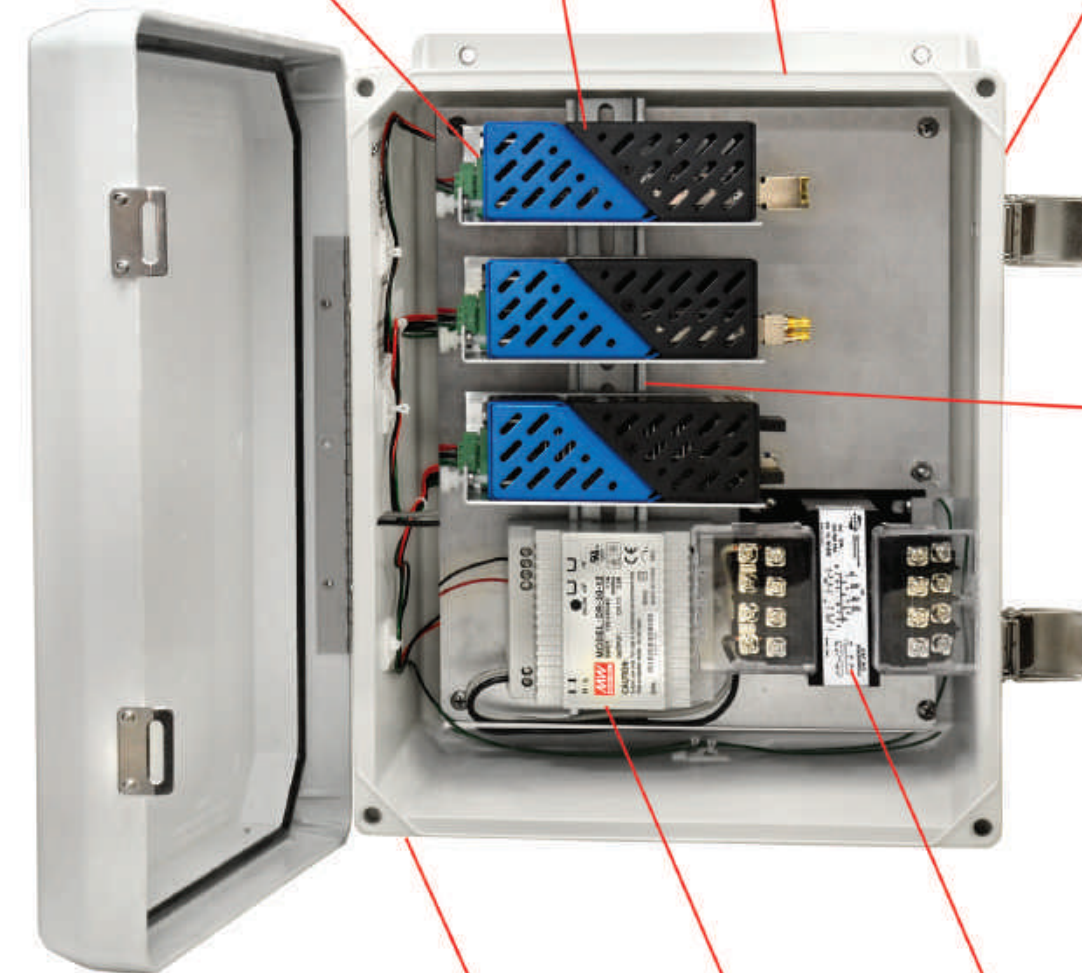

Securely seats modules with TD-DINR mounting clips for DIN rail (see page 27)

For use with all TD Series modules

DIN rail power supply included

Optional step-down transformer accepts 208/277/380 VAC industrial power

Model TNE-03

Product Line Overview—Product Style TD

TD 6-Position Truss Mount

The Truss Mount provides connection, mounting, power, and cable management for up to 6 front-facing TD modules in a rugged aluminum truss mountable package.

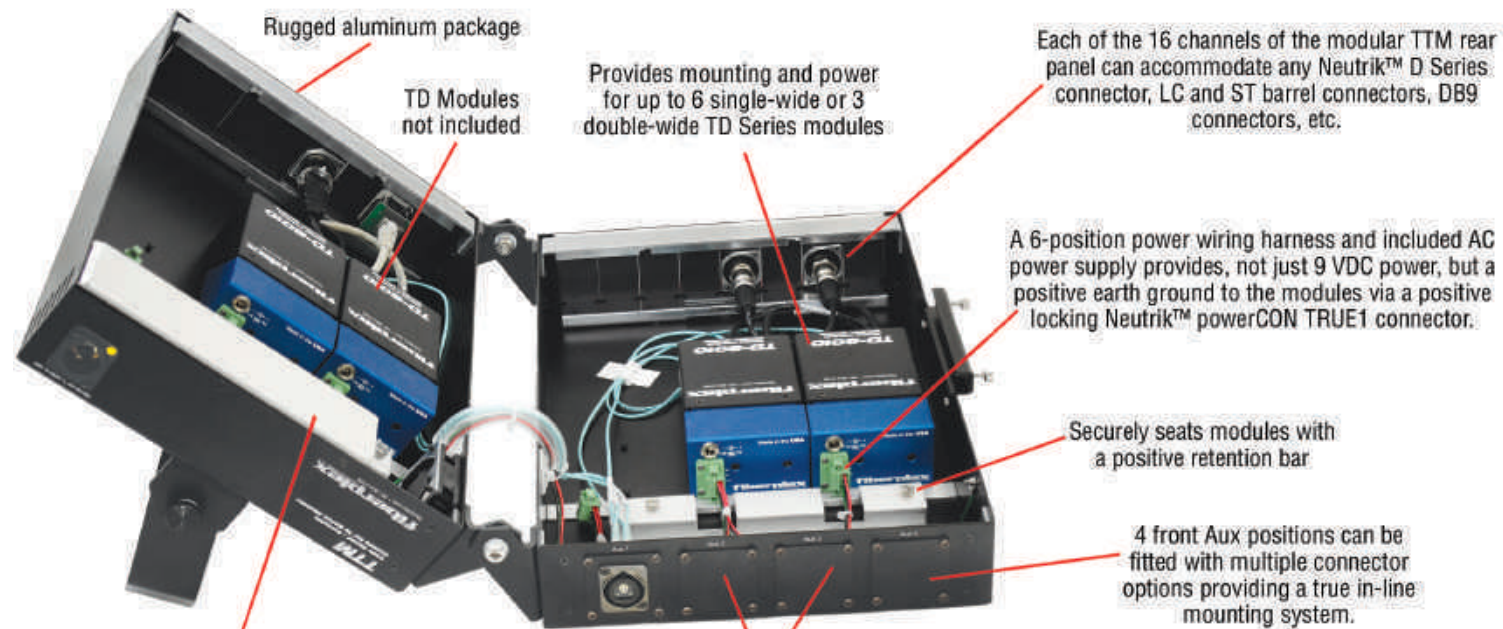

Model TTM

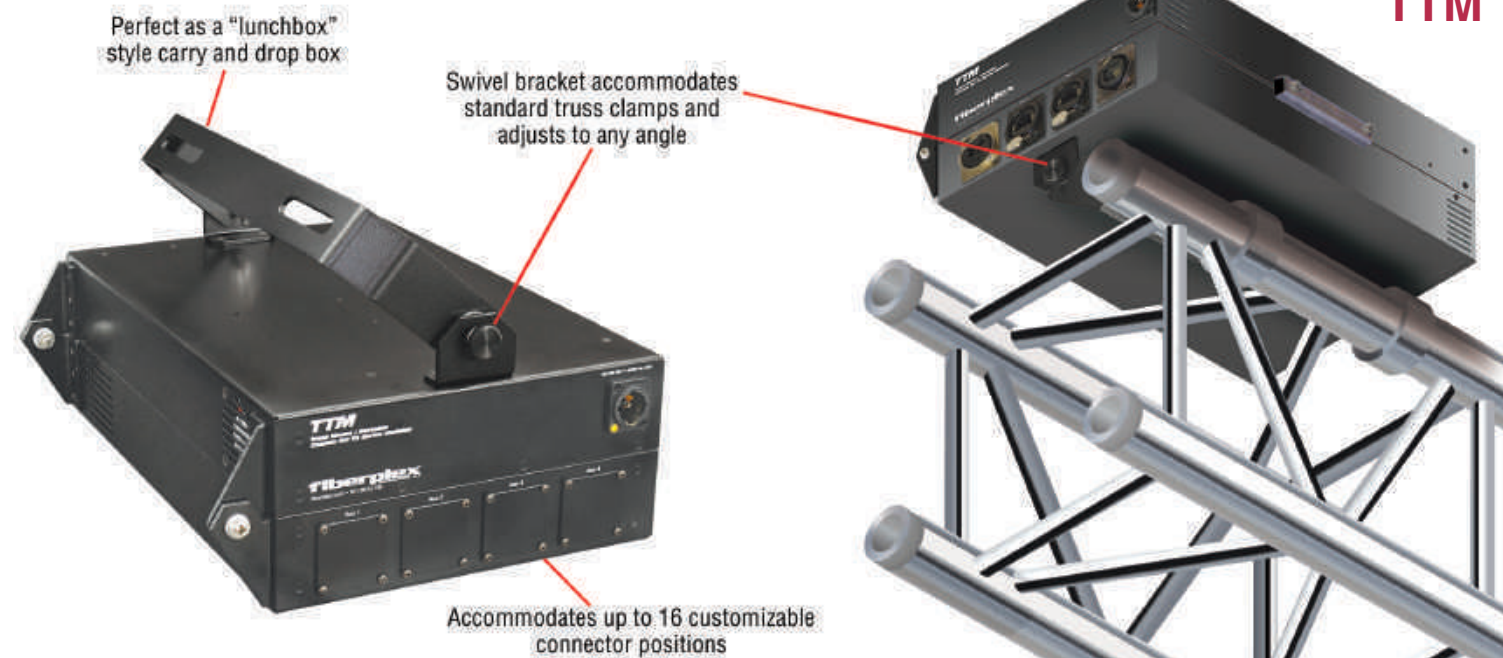

TD Kits

TD Kits are paired-up bundles of TD units for the most common point-to-point fiber links. The kits combine the flexibility of our TD-6010 12.5-Gbps workbox with application-specific SFP modules to create simple, easy-to-order-solutions for your applications.



Kits

- ✓ 3G SDI Video Fiber Link Kits (TKIT-3GXC-M & TKIT-3GXC-S)
- ✓ HDMI Video Fiber Link Kits (TKIT-HDMI-M & TKIT-HDMI-S)
- ✓ Analog Composite Video Fiber Link Kits (TKIT-SDXC-M & TKIT-SDXC-S)
- ✓ AES-10 (MADI) Fiber Link Kits (TKIT-MADI-M & TKIT-MADI-S)
- ✓ Networked Audio (DANTE/AVB) Fiber Link Kits (TKIT-DANTE-M & TKIT-DANTE-S)
- ✓ 10/100/1000 BASE-T Fiber Link Kits (TKIT-ETH-M & TKIT-ETH-S)
- ✓ Multimode to Singlemode Conversion Kits (TKIT-MODE-155, TKIT-MODE-1G, TKIT-MODE-3G)
- ✓ Optical Repeater Conversion Kits (TKIT-RPTR)

TD DIN Rail Mounting Bracket

The bracket mounts a single TD-Series unit onto any DIN rail that conforms to standard EN 50022.

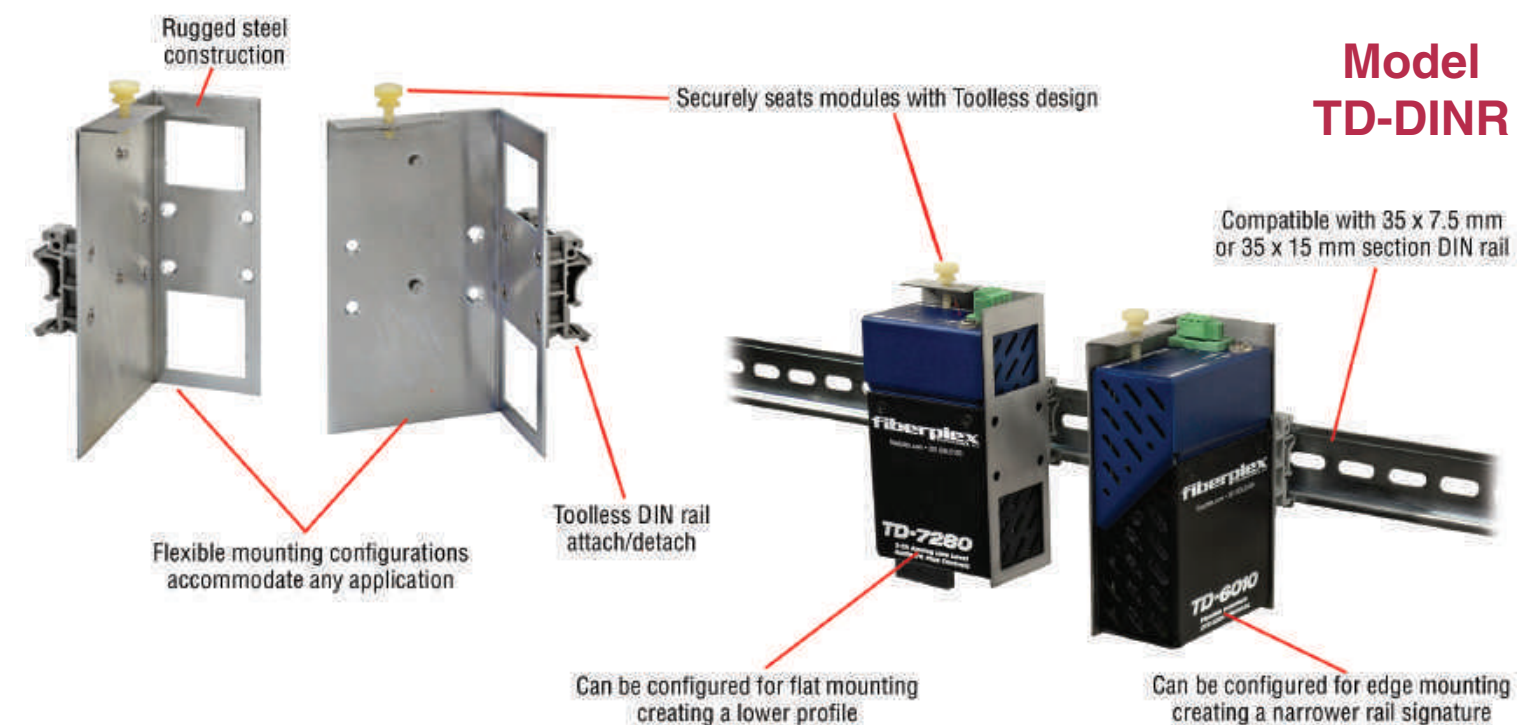

Model TD-DINR

Product Line Overview—Product Style TD

TD 6-Position Front-Connect Rack Chassis

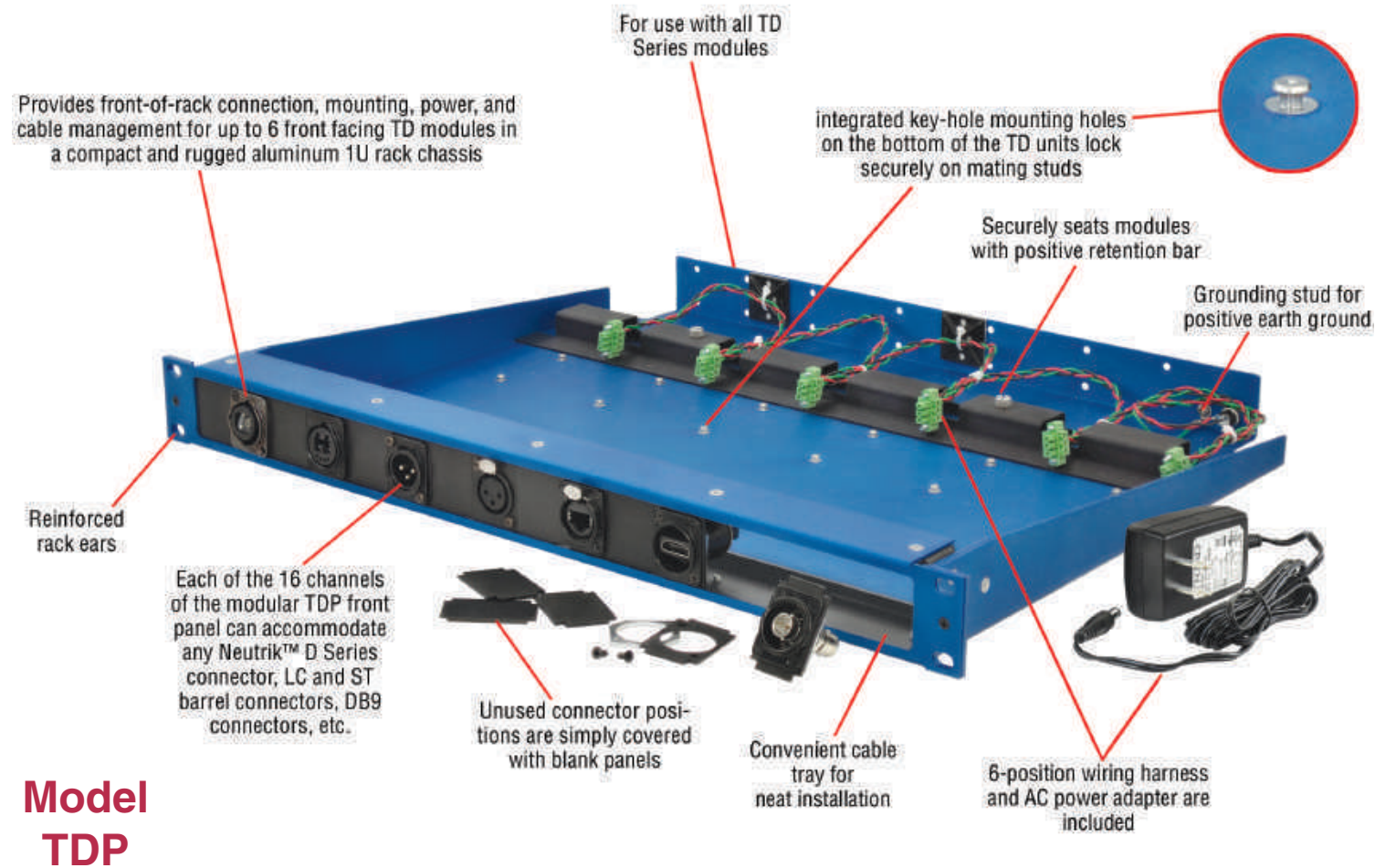

Preconfigured 4x4 3G-SDI HD Video plus Audio and Control



Preconfigured 4 HD-SDI Video plus 10/100/1000 Ethernet



TD 6-Position Rear-Connect Rack Chassis

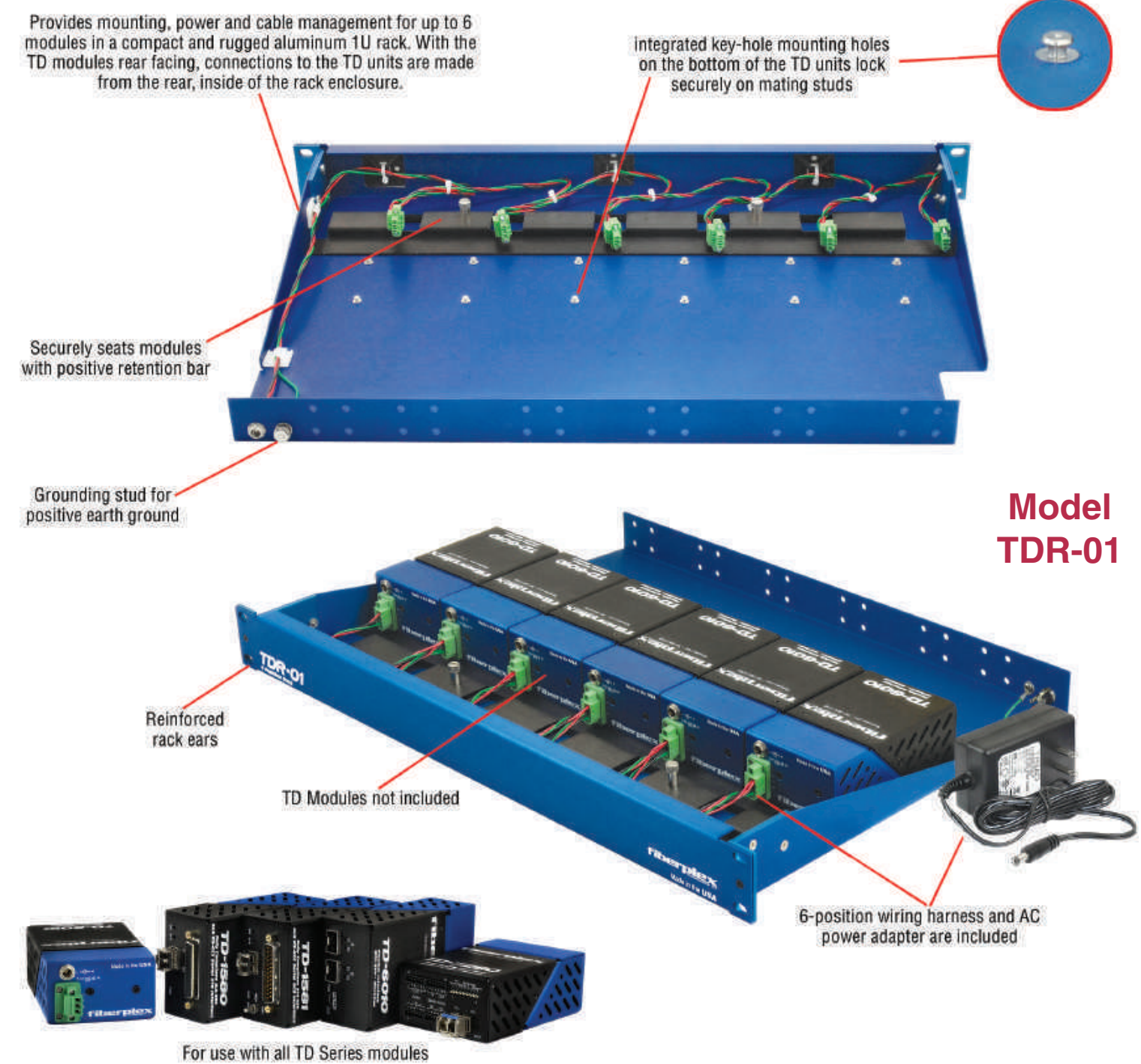

Product Line Overview—By Interface Type

Interface Type	Interfaces	Series	Models	Page	
Serial Datacom Asynchronous & Synchronous Communications Interfaces	TIA/RS-232	FOM-1090	FOM-1090 (to DCE), FOM-1091 (to DTE)	50	
		FOI-2191	FOI-2191 (to DCE), FOI-2911 (to DTE)	38	
		FOI-2591	FOI-2951 (to DCE), FOI-2951 (to DTE)	39	
		FOI-4141	FOI-4141 (to DCE), FOI-4411 (to DTE)	39	
		FOI-4451	FOI-4451 (to DCE), FOI-4541 (to DTE)	39	
		TD-1280	TD-1280 (to DTE), TD-1281 (to DCE)	44	
		TIA/RS-422/485/530	FOM-1090	FOM-1090 (to DCE) FOM-1091 (to DTE)	50
	TD-1580		TD-1580 (to DTE), TD-1581 (to DCE)	43	
	CCITT V.35/X.21	FOI-4341	FOI-4341 (to DCE), FOI-4431 (to DTE)	39	
		FOM-1090	FOM-1090 (to DCE) FOM-1091 (to DTE)	50	
	MIL-STD-188-114A	TD-1580	TD-1580 (to DTE), TD-1581 (to DCE)	43	
	Telecom Analog & Digital Telephone & Network Interfaces	Analog POTS (FXS/FXO)	FOI-2971	FOI-2971 (to Line), FOI-4972 (to Device)	40
			FOM-3840	FOM-3841 (to Line), FOM-3842 (to Device)	50
TDU-4000			TDU-4000	37	
ISDN S/T		FOI-5601	FOI-5601	42	
		FOM-5600	FOM-5600	39	
		TD-5601	TD-5601	44	
E&M		FOI-7280	FOI-7280	42	
		TD-7280	TD-7280	44	
T1/E1/PR		FOI-5601	FOI-5401	41	
		FOI-5400	FOI-5401 (T1), FOI-5402 (E1)	41	
		FOM-5400	FOM-5400	49	
		TD-5400	TD-5401 (T1), TD-5402 (E1)	44	
		SFP-OC	SFP-OC	48	
		FOI-6010	FOI-6010 (Single Transceiver), FOI-6012 (Dual TX or Dual RX)	42	
		T3/STS/OC-1-OC-192	FOI-DSE3	FOI-DSE3 (E3), FOI-DSE3 (T3)	41
SFP-OC			SFP-OC	48	
FOI-6010			FOI-6010 (Single Transceiver), FOI-6012 (Dual TX or Dual RX)	42	
FOI-STS1			FOI-STS1	41	
Video Analog, Standard Definition & High Definition Video Interfaces		Analog Composite	FOI-2170	FOI-2170 (with AGC), FOI-2171 (without AGC)	38
		SD-SDI	TKIT-SD	TKIT-SD	47
			SFP-BSDV	SFP-BSDV	48
	FOI-6010		FOI-6010 (Single Transceiver), FOI-6012 (Dual TX or Dual RX)	42	
	3G-SDI	TKIT-3G	TKIT-3G	45	
		SFP-BHDV	SFP-BHDV	47	
		FOI-6010	FOI-6010 (Single Transceiver), FOI-6012 (Dual TX or Dual RX)	42	
	HDMI 1.4	TKIT-HDMI	TKIT-HDMI	46	
		SFP-HHDV	SFP-HHDV	48	
		FOI-6010	FOI-6010 (Single Transceiver), FOI-6012 (Dual TX or Dual RX)	42	

Interface Type	Interfaces	Series	Models	Page	
Audio Mic Level, Line Level, Digital & Multi-Channel Pro Audio Interfaces	Analog Mic Level	VIM-1832	VIM-1832 (Clock Master), VIM-1032 (Clock Slave)	54	
		VRK-1832	VRK-1832	55	
	Analog Line Level	VIM-1808	VIM-1808 (Clock Master), VIM-0808 (Clock Slave)	54	
		VIM-1832	VIM-1832 (Clock Master), VIM-1032 (Clock Slave)	54	
		VRK-1832	VRK-1832	55	
		FOI-7280	FOI-7280	42	
		FOI-2980	FOI-2981 (Transmitter line level), FOI-2983 (Transmitter 70V dist), FOI-4982 (Receiver)	40	
	2-Wire Analog	TD-7282	TD-7282	45	
	AES3	VIM-1808	VIM-1808 (Clock Master), VIM-0808 (Clock Slave)	54	
		VIM-1832	VIM-1832 (Clock Master), VIM-1032 (Clock Slave)	54	
		VIS-4832	VIS-4832	55	
	AES10 (MADI)	SFP-BA10	SFP-BA10	47	
		TKIT-MADI	TKIT-MADI	46	
	AVB	TKIT-DANTE	TKIT-DANTE	46	
		TKIT-ETH	TKIT-ETH	46	
	DANTE	TKIT-DANTE	TKIT-DANTE	46	
		TKIT-ETH	TKIT-ETH	46	
	IT, Ethernet & Networking Ethernet Interfaces from 10 Mbps to 10 Gbps	10/100Base-T	FOI-4110	FOI-4110	38
			SFP-OC	SFP-OC	48
			SFP-RT	SFP-RT	49
			FOI-6010	FOI-6010 (Single Transceiver), FOI-6012 (Dual TX or Dual RX)	42
10/100/1000Base-T		TKIT-ETH	TKIT-ETH	46	
		TIS-8632	TIS-8632	45	
		SFP-OC	SFP-OC	48	
		SFP-RT	SFP-RT	49	
		FOI-6010	FOI-6010 (Single Transceiver), FOI-6012 (Dual TX or Dual RX)	42	
100Base-FX, SX, BX10, LX10		TKIT-ETH	TKIT-ETH	46	
		TIS-8632	TIS-8632	45	
		SFP-OC	SFP-OC	48	
		SFP-RT	SFP-RT	49	
1000Base-SX, BX10, LX10, ZX		FOI-6010	FOI-6010 (Single Transceiver), FOI-6012 (Dual TX or Dual RX)	42	
		FOI-1GBT	FOI-1GBT	38	
	TKIT-ETH	TKIT-ETH	46		
	SFP-OC	SFP-OC	48		
	TIS-8632	TIS-8632	45		
10G Ethernet	SFP-RT	SFP-RT	49		
	FOI-6010	FOI-6010 (Single Transceiver), FOI-6012 (Dual TX or Dual RX)	42		
	SFP-OC	SFP-OC	48		
SCADA, Alarming, Relay & Control Contact Closure, Actuation and Sensor Control Interfaces	Contact Closure (Form A & C)	FOI-2990	FOI-2991 (Transmitter 0-5VDC), FOI-2992 (Transmitter +12 -24 VAC/VDC), FOI-2993 (Receiver 12 SPST, Form A), FOI-2994 (Receiver 8 SPDT, Form C)	40	
		FOM-9010	FOM-9010 (12 ch; CC or voltage), FOM-9011 (8 ch; Form C solid), FOM-9012 (12 ch; SPST Form A or B CC)	49	
		FOI-2890	FOI-2890	40	
	Voltage Actuation	FOI-2990	FOI-2991 (Transmitter 0-5VDC), FOI-2992 (Transmitter +12 -24 VAC/VDC), FOI-2993 (Receiver 12 SPST, Form A), FOI-2994 (Receiver 8 SPDT, Form C)	40	
		FOM-9010	FOM-9010 (12 ch; CC or voltage), FOM-9011 (8 ch; Form C solid), FOM-9012 (12 ch; SPST Form A or B CC)	49	
		FOI-2890	FOI-2890	40	
	Shorting Contact	FOI-2990	FOI-2991 (Transmitter 0-5VDC), FOI-2992 (Transmitter +12 -24 VAC/VDC), FOI-2993 (Receiver 12 SPST, Form A), FOI-2994 (Receiver 8 SPDT, Form C)	40	
		FOM-9010	FOM-9010 (12 ch; CC or voltage), FOM-9011 (8 ch; Form C solid), FOM-9012 (12 ch; SPST Form A or B CC)	49	
		FOI-2890	FOI-2890	40	
	Analog Sensors	FOI-7280	FOI-7280	42	

Product Line Overview—Products by Category

Product Category	Product Line	Series	Models	Page	
Defense/Security Fiber Communications	Tactical Radio Fiber Systems	PKG-CCRP	PKG-CCRP	56	
	TEMPEST Emanations Filter	SID-3232	SID-3232	56	
Ethernet Over Fiber	Ethernet Isolators/Converters/Modems	FOI-1GBT	FOI-1GBT	38	
		FOI-4110	FOI-4110	38	
	Ethernet Over Fiber Extender Kits (2-Pack)	TKIT-ETH	TKIT-ETH	46	
	Industrial Copper/Fiber/SFP Ethernet Switch	TIS-8632	TIS-8632	45	
Fiber Alarming, Notification, Relay & Control	Contact Closure Systems	FOI-2990	FOI-2991 (Transmitter 0–5VDC), FOI-2992 (Transmitter +12 - 24 VAC/VDC), FOI-2993 (Receiver 12 SPST, Form A), FOI-2994 (Receiver 8 SPDT, Form C)	40	
		FOM-9010	FOM-9010 (12 ch; CC or voltage), FOM-9011 (8 ch; Form C solid), FOM-9012 (12 ch; SPST Form A or B CC)	49	
	Intercom, Alarm & Emergency Notification Systems	ADP-2980	ADP-2981 (with strobe), ADP-2982 (without strobe)	40	
		TD-7282	TD-7282	45	
	Line Level Stereo Audio (Analog) or E&M + Data (RS-232/RS-422/RS-485) Systems	FOI-7280	FOI-7280	42	
	Fiber Rack & Enclosure Systems	NEMA Package on Mounting Kits (for TD units)	TNE-03	TNE-03	48
Rack Mount Chassis (for FOM and FOI)		RMC-2100	RMC-2100	42	
		RMC-3100	RMC-3100	43	
		RMC-3700	RMC-3700	43	
		RMC-5000	RMC-5000	51	
Standalone (Desktop) Enclosures (for FOM cards)		SAC-1	SAC-1	50	
Fiber Repeaters & Wavelength Division Multiplexers (WDM)		Optical Repeaters	TKIT-RPTR	TKIT-RPTR	47
	Optical Add/Drop Multiplexers	TD-OADM	TD-OADM	52	
		WDM Multiplexers	WDM16	WDM16	51
	WDM Multiplexers	WDM8	WDM8	51	
		WDP16	WDP16	52	
		WDP8	WDP8	52	
Fiber Serial Datacom (RS-232/RS-422/RS-530/MIL-STD-188C)		High Speed Async./Sync TIA-RS-232/RS-530/RS-530A/RS-574/RS-449/V.35/X.21	FOM-1090	FOM-1090 (to DCE), FOM-1091 (to DTE)	50
	High Speed RS-232 (MIL-STD-188C) Products	FOI-4451	FOI-4451 (to DCE), FOI-4541 (to DTE)	39	
	High Speed RS-422/RS-530 (MIL-STD-188C-114A) Products	TD-1580	TD-1580 (to DTE), TD-1581 (to DTE)	43	
	Low Speed RS-232 (MIL-STD-188C) Products	FOI-2191	FOI-2191 (to DCE), FOI-2911 (to DTE)	38	
		FOI-4141	FOI-4141 (to DCE), FOI-4411 (to DTE)	39	
		TD-1280	TD-1280 (to DTE), TD-1281 (to DCE)	44	
	Fiber Telecom (T1/E1/PRI, Analog & ISDN)	Analog (POTS) FXS/FXO Fiber Products	FOI-2971	FOI-2971 (to Line), FOI-4972 (to Device)	40
			FOM-3840	FOM-3841 (to Line), FOM-3842 (to Device)	50
		E3/DSE3 Fiber Products	TDU-4000	TDU-4000	37
FOI-DSE3			FOI-DSE3 (E3), FOI-DST3 (T3)	41	

Product Category	Product Line	Series	Models	Page
Fiber Telecom (T1/E1/PRI, Analog & ISDN)	Fiber Isolators for Nortel Meridian Systems	FOI-5601	FOI-5601	50
		FOI-5601	FOI-5601	41
	ISDN BRI S/T Fiber Products	FOM-5600	FOM-5600	49
		TD-5601	TD-5601	44
	Sync. Serial V.35 Fiber Products	FOI-4341	FOI-4341 (to DCE), FOI-4431 (to DTE)	39
	T1/E1/PRI Fiber Products	FOI-5400	FOI-5401 (T1), FOI-5402 (E1)	41
		FOM-5400	FOM-5400	49
		TD-5400	TD-5401 (T1), TD-5402 (E1)	43
	T3/STS/OC-1 Fiber Products	FOI-DSE3	FOI-DSE3 (E3), FOI-DST3 (T3)	41
		FOI-STS1	FOI-STS1	41
Pro AV Live & Media Broadcast Fiber Systems	Composite Video Fiber Products	FOI-2170	FOI-2170 (with AGC), FOI-2171 (without AGC)	38
	Optical Audio Transport Products	VIM-1808	VIM-1808 (Clock Master), VIM-0808 (Clock Slave)	54
		VIM-1832	VIM-1832 (Clock Master), VIM-1032 (Clock Slave)	54
		VRK-1832	VRK-1832	55
		VIS-4832	VIS-4832	55
	Pro-AV Fiber Extender/Converter Kits	TKIT-3G	TKIT-3G	45
		TKIT-DANTE	TKIT-DANTE	46
		TKIT-HDMI	TKIT-HDMI	46
		TKIT-MODE	TKIT-MODE	47
		TKIT-SD	TKIT-SD	TKIT-SD
TKIT-SD			TKIT-SD	47
SFP (Small Form Pluggable) Modules & Kits	Copper SFP Analog HD Video Modules	SFP-BSDV	SFP-BSDV	48
	Copper SFP HD Video Modules	SFP-BHDV	SFP-BHDV	47
		SFP-HHDV	SFP-HHDV	48
	Copper SFP Modules	SFP-RT	SFP-RT	49
	Copper SFP Multi-Channel Audio Modules	SFP-BA10	SFP-BA10	47
	Fiber SFP Data Modules	SFP-OC	SFP-OC	48
	Fiber SFP Video Modules	SFP Video	SFP Video	48
	Universal SFP to SFP Workbox	FOI-6010	FOI-6010 (Single Transceiver), FOI-6012 (Dual TX or Dual RX)	42
TD-6010		TD-6010 (Single Transceiver), TD-6012 (Dual TX or Dual RX)	45	
Waveguide RF Filters	Waveguide Extensions/Accessories	WEB/WET	WEB (Brass), WET (PVC)	53
		WGN/WCN	WGN (Nut), WCN (Coupling Nut)	53
		WEN	WEN	52
	Waveguides	WGF	WGF-12 (12 slots), WGF-6 (6 slots), WGG-461 (4 slots, MIL-461)	52

Major Market Segments



Defense & Intelligence

- ▶ Support for a wide variety of C4ISR programs worldwide
- ▶ Products to support SIGINT and Information Assurance (IA)
- ▶ A trusted source for high reliability secure fiber transport
- ▶ The most advanced and superior isolation and containment options

FiberPlex products support offensive and defensive tactical surveillance, command control communication and battlefield communications.

FiberPlex products have long delivered mission-critical equipment for the U.S. Department of Defense and the U.S. Intelligence Community. These agencies have trusted FiberPlex products to protect their data for more than a quarter century, safeguarding the transmissions of the nation's most critical and sensitive information—no matter where it goes.



Civilian Government Agencies

- ▶ Broad communications installations in embassies worldwide
- ▶ Secure radio isolation for DoS, DHS, and DISA applications
- ▶ Communications, security, AV, and IT infrastructure support FiberPlex solutions provide secure transportation of the Civilian Government's most critical content.

Protecting communications, data, and maintaining control is vital in today's global environment. Whether there is a need to safeguard citizen safety or boost national competitiveness, FiberPlex products support civilian government helping achieve their public service missions.

FiberPlex products provide secure and field-proven transport, isolation, and containment of Civilian Government mission's most critical content.



System Integration

- ▶ Maximize the use of existing fiber infrastructure
- ▶ Extend the useful life of legacy equipment by porting to fiber
- ▶ Save margin on labor expense by using plug-and-play equipment
- ▶ Create a forward-thinking, cutting-edge, and competitive integration

From the conference room to the campus, sound to security, FiberPlex product help integrators build and support future proof infrastructure.

In conference rooms, theaters, campuses, hospitals, and other facilities all over the world the convergence of Audio/Video/IT/Telecom/Security has become the norm. It's not enough to just specialize on one of these disciplines. They all work together now. The perfect backbone for all of them is fiber.



Energy & Transportation

- ▶ Transport for SCADA sensor collection and extension
- ▶ Perimeter security
- ▶ IP and serial monitoring and control
- ▶ Ruggedized industrial mounting options

From SCADA collection, to real-time signaling and monitoring, FiberPlex products support the demands of the energy and transportation industries.

Energy and transportation infrastructure are vital to a thriving economy and to national security. Today's infrastructure is smarter and more efficient than ever. While it offers new opportunities, it also presents new vulnerabilities. Data reliability and security are critical to a well-functioning system. Sensors, monitoring, control, and safety are key components to making things run smoothly.

From green energy to oil, gas, mining or traffic control, rail, and maritime, FiberPlex technology ensures your data travels quickly and safely without compromise.

Major Market Segments



Broadcast & Production

- ▶ Mission-critical quality in rugged tactical packaging
- ▶ Flexible modular video solutions
- ▶ Variety of audio solutions to meet your specific application
- ▶ Uncompressed HD transport
- ▶ High-density multiplexing to minimize fiber counts

The bigger event, the bigger stage, the more important is the need for lightweight and durable fiber optic solutions that will perform flawlessly under pressure.

The world of broadcast, recording, and live entertainment places high demands on digital communications. Studio, remote, and location scenarios can all benefit from the noise rejection, longer distance, lighter weight, and high bandwidth advantages of a fiber infrastructure.

The FiberPlex products offer a flexible range of transport options for audio, video, and data, as well as innovative high-density multiplexing solutions.



Manufacturing & Industrial

- ▶ Enhanced data integrity with EMI/RFI noise rejection
- ▶ Monitoring and controlling machinery and processes
- ▶ Protecting intellectual property from theft
- ▶ Using waveguides for EMI/RFI isolation in shield room penetrations
- ▶ Extended distances of communications equipment

FiberPlex products offer connectivity solutions for the harshest and noisiest environments.

Manufacturing facilities present a unique set of challenges for communications infrastructure. They often contain high levels of EMC/EMI/RFI noise that can interrupt and corrupt data transmission. They are frequently not the cleanest environments, which creates harsh conditions for electronic equipment. And many times, there are multiple buildings connected with limited infrastructure.

FiberPlex Products

ADP-2980 Series

Models: ADP-2981 (with strobe) | ADP-2982 (without strobe)

Annunciator Speaker

The ADP-2981/ADP-2982 are stand-alone wall or shelf mountable loudspeaker units. Each unit houses and powers an 8-inch speaker. The ADP-2981 also contains a strobe annunciator, useful for areas with high background noise or those with hearing difficulties. A knob on top of the unit controls the volume threshold that the audio must exceed for the strobe to flash. Each ADP unit is equipped with an AC line-powered supply to drive the amplifier and supply DC power to an attached FOI module.

These are recommended for use with the FiberPlex FOI series FOI-2981 for line level or the FOI-2983 for 70V audio. These FOI units then transmit the signal via a fiber optic link to a FOI-4982, conveniently housed and powered by an ADP unit. From there the FOI-4982 drives up to 10 ADP units in a daisy chain.

- ✓ Provides power to a single FOI Module
- ✓ Accepts unbalanced line level audio from any FOI audio source including FOI-4982, FOI-7280 or other FiberPlex FOI line level audio devices.
- ✓ Backwards compatible with legacy FOI-2982 with optional spacer installed.
- ✓ ADP units may be linked on a copper audio daisy-chain scheme, up to 10 units long, with no unit configuration required.



ADP-2981



ADP-2982

FAK-2980 Series

Models: FAK-2981 (with strobe) | FAK-2982 (without strobe)

Fire Alarm Kit

The kits are complete bundled packages for fire alarm annunciation applications. The FAK-2981 comes with a warning strobe; the FAK-2982 does not have a strobe.

The kits include everything you need to set up a fire alarm: ADP-2980 speaker, wall mount adapter, power supply for the FOI-2981, 26-foot (8-meter) multimode fiber ST-ST cable, FOI-2981, and FOI-4982.

- ✓ FAK-2981 Fire Alarm Kit including loudspeaker with strobe
- ✓ FAK-2982 Fire Alarm Kit including loudspeaker without strobe



FAK-2981



FAK-2982

TDU-4000

Telephone Disconnect Unit

The TDU-4000 provides protection for phones from being used as clandestine listening devices by electrically disconnecting the telephone line from the phone when the phone is in the "on hook" position. During disconnect the telephone line is left open, while the voice path on the phone is grounded. This disables room audio from being transmitted onto the telephone line to prevent any eavesdropping. The phone will only connect to the telephone line when it is in the "off hook" position. The "off hook" detect and "ring" detect signals are also opto-isolated from the phone.

- ✓ Supports rates from DC to 1 Mbps
- ✓ Compatible with standard POTS phones, STU-III phones, fax machines and modems
- ✓ Units will not allow propagation of signals to the central office or PBX when phone is on-hook



FOI-1GBT Series

Gigabit Ethernet (1000Base-TX)

The FOI-1GBT is a rock-solid plug-and-play device that does media conversion *and* extension of Ethernet over fiber. Auto MDI/MDIX enables users to use a straight-through or crossover cable for any LAN configurations, and will adjust polarity +/- and TX/RX automatically.

- ✓ Extends 1000Base-T Ethernet up to 1,804 ft (550 m) over multimode cable, 3.1 miles (5.0 km) over singlemode
- ✓ Compliant with IEEE 802.3ab
- ✓ Optically compatible with Ethernet optical standards



FOI-4110 Series

Fast Ethernet (10/100Base-TX)

The FOI-4110 is a flexible solution for the converting 10Base-T to 10Base-FL, and 100Base-TX to 100Base-SX or just plain extending your copper Ethernet signal. Auto MDI/MDIX enables users to use either a straight-through or crossover cable for any LAN configurations and will adjust polarity +/- and TX/RX automatically.

- ✓ Extends 10/100Base-TX Ethernet up to 1,804 ft (550 m) over multimode cable, 3.1 miles (5.0 km) over singlemode
- ✓ Optical interface options include ST, SC, and FC
- ✓ Compliant with IEEE 802.3, TIA/EIA-785
- ✓ Optically compatible with Ethernet optical standards



FOI-2170 Series

Unidirectional Composite Video

Models: FOI-2170 (with AGC) | FOI-2171 (without AGC)

The FOI-2170 and FOI-2171 provide complete electrical isolation for composite video communications. The units are compatible with several video broadcast standards. The units are transparent to all monochrome, color, and closed circuit video. The FOI-2171 has an AGC (automatic gain control) to stabilize the video output for different fiber optic cable lengths. Adjusting the AGC potentiometer will also increase or decrease the overall scene brightness.

- ✓ Compatible with NTSC, PAL, and SECAM
- ✓ Compatible with EIA/RS-170/170A, EIA/RS-330
- ✓ Supports video bandwidths from 4 Hz to 7 MHz
- ✓ Multimode extension up to 1.2 miles (2 km)



FOI-2191 Series

Serial Converter RS-232, 128 kbps

Models: FOI-2191 (to DCE) | FOI-2911 (to DTE)

Used in pairs, the FOI-2191 and FOI-2911 provide end-to-end conversion, extension, and electrical isolation of RS-232 circuits up to a maximum data rate of 128 kbps. These units are transparent to all handshaking protocols, and can accept data and clock signals. A regeneration switch on the FOI-2191 enables users to toggle between synchronous applications that require send timing (ST), and asynchronous or synchronous applications that require terminal timing (TT).

- ✓ Tail circuit and null-modem functions for DCE to DCE or DTE to DTE
- ✓ Pair with another FOI with V.35 or RS-422 interfaces for interface conversion
- ✓ TD and RD inversion switch for MIL-STD-188C compatibility
- ✓ Multimode extension of up to 1.2 miles (2 km), singlemode extension up to 12.4 miles (20 km)



FOI-4141 Series

Serial Converter RS-232, 1 Mbps

Models: FOI-4141 (to DCE) | FOI-4411 (to DTE)

Used in pairs, the FOI-4141 and FOI-4411 provide end-to-end conversion, extension and electrical isolation of RS-232 circuits up to a maximum data rate of 1 Mbps. These units are transparent to all handshaking protocols, and accept data and clock signals. A regeneration switch on the FOI-4141 allows users to toggle between synchronous applications that require send timing (ST) and asynchronous or synchronous applications that require terminal timing (TT). Compatible with TIA/EIA-423 (RS-423), FED-STD-1020A, TIA/EIA-694 (RS-694), TIA/EIA-723 (RS-723)

- ✓ Tail circuit and null modem functions for DCE to DCE or DTE to DTE.
- ✓ Pair with other FOI with V.35 or RS-422 interfaces for interface conversion.
- ✓ Multimode extension of up to 1.2 miles (2 km), singlemode extension up to 12.4 miles (20 km)



FOI-2591 Series

Serial Converter EIA-530/RS-422, 256 kbps

Models: FOI-2591 (to DCE) | FOI-2951 (to DTE)

Used in pairs, the FOI-2591 and FOI-2951 provide end-to-end conversion, extension, and electrical isolation of EIA-530/RS-422 circuits. The units are transparent to all handshaking protocols, and can accept data and clock signals up to a maximum rate of 256 kbps. A regeneration switch on the FOI-2591 enables users to toggle between synchronous applications that require send timing (ST) and asynchronous or synchronous applications that require terminal timing (TT).

- ✓ Tail circuit and null modem functions for DCE to DCE or DTE to DTE
- ✓ Pair with other FOI with V.35 or RS-232 interfaces for interface conversion
- ✓ Multimode extension of up to 1.2 miles (2 km), singlemode extension up to 12.4 miles (20 km)



FOI-4341 Series

Serial Converter V.35, 6 Mbps

Models: FOI-4341 (to DCE) | FOI-4431 (to DTE)

Used in pairs, the FOI-4341 and FOI-4431 provide end-to-end conversion, extension, and electrical isolation of V.35 circuits. The units are transparent to all handshaking protocols, and can accept data and clock signals up to a maximum rate of 6.144 Mbps. A regeneration switch on the FOI-4341 enables users to toggle between synchronous applications that require send timing (ST), and asynchronous or synchronous applications that require terminal timing (TT).

- ✓ Tail circuit and null modem functions for DCE to DCE or DTE to DTE
- ✓ Pair with another FOI with EIA-530/RS-422 or RS-232 interfaces for interface conversion
- ✓ Multimode extension of up to 1.2 miles (2 km), singlemode extension up to 12.4 miles (20 km)



FOI-4451 Series

Serial Converter EIA-530/RS-422, 6 Mbps

Models: FOI-4451 (to DCE) | FOI-4541 (to DTE)

Used in pairs, the FOI-4451 and FOI-4541 provide end-to-end conversion, extension, and electrical isolation of EIA-530/RS-422 circuits. The units are transparent to all handshaking protocols, and can accept data and clock signals up to 6.144 Mbps. A regeneration switch on the FOI-4451 enables users to toggle between synchronous applications that require send timing (ST), and asynchronous or synchronous applications that require terminal timing (TT).

- ✓ Tail circuit and null modem functions for DCE to DCE or DTE to DTE
- ✓ Pair with other FOI with V.35 or RS-232 interfaces for interface conversion
- ✓ Multimode extension of up to 1.2 miles (2 km), singlemode extension up to 12.4 miles (20 km)



FOI-2890 Series

Duplex Alarm with Controls

The FOI-2890 provides complete electrical isolation for 4 channels of control signals and relay closures, and 2 channels of asynchronous or synchronous RS-232 communications. During power failures or interruptions, the relays will hold the last commanded state until power is restored and the relays are commanded differently. This model is ideal for applications that include alarm indicators, lock actuators, and HVAC instrumentation and control.

- ✓ Four 0 to +5VDC inputs
- ✓ Four SPST form A relay closures
- ✓ Two TIA/EIA-232 (RS-232) TX and RX; compatible with MIL-STD-188C
- ✓ Multimode extension of up to 1.2 miles (2 km), singlemode extension up to 12.4 miles (20 km)



FOI-2971 Series

POTS Fiber Converter

Models: FOI-2971 (to Line) | FOI-4972 (to Device)

The FOI-2971 and FOI-4972 provide complete electrical isolation for 2-wire telephone lines. The FOI-2971 connects to the POTS (plain old telephone service) line, and the FOI-4972 connects directly to the analog phone or modems. In addition to standard analog phones, the FOI-2971 is compatible with STU-III (secure telephone unit) phones and STE (secure telephone equipment) phones.

- ✓ Caller ID supported
- ✓ FOI-4972 has solid state relays that can be used to activate external signaling devices when ringing is detected.
- ✓ FOI-4972s can be used back-to-back for a private-line automatic-ringdown circuit



FOI-2980 Series

Audio Line Level 2Ch + Doorbell In

Models: FOI-2981 (Transmitter line level) | FOI-2983 (Transmitter 70V dist) | FOI-4982 (Receiver)

The FOI-2980 Series and FOI-4982 provide electrical isolation and audio line extension. A typical link consists of an FOI-2981 at one end of the network transmitting optical signals to an FOI-4982 at the other end of the network. This multi-use box is excellent for providing voice announcements, background music and dry-contact doorbell connectivity over fiber.

- ✓ FOI-2981 Optical Transmitter: 2 audio inputs; 1 doorbell input
- ✓ FOI-2983 Optical Transmitter: 2 audio inputs; 1 doorbell input (1 audio input used for 70V distribution systems)
- ✓ FOI-4982 Optical Receiver: 2 audio outputs (8 ohm and 600 ohm)



FOI-2990 Series

Control Signal and Relay Contacts

Models: FOI-2991 (Transmitter 0-5VDC) | FOI-2992 (Transmitter +12 to -24 VAC/VDC) | FOI-2993 (Receiver 12 SPST, form A) | FOI-2994 (Receiver 8 SPDT, form C)

The FOI-2990 series provide electrical isolation and extension of control signals and relay closures. The units are uni-directional. The FOI-2991 and FOI-2992 can accept up to 12 individual control signals. During power interruptions or failures, the relays on the optical receiver units will hold the last commanded state until power is restored and the relays are commanded differently.

- ✓ FOI-2991 Optical Transmitter: 0 to +5 VDC inputs
- ✓ FOI-2992 Optical Transmitter: +12 to -24 VAC/VDC inputs
- ✓ FOI-2993 Optical Receiver: 12 SPST form A latching relay closures
- ✓ FOI-2994 Optical Receiver: 8 SPDT form C latching relay closures



FOI-5400 Series

T1/E1 Fiber Extender

Models: FOI-5401 (T1) | FOI-5402 (E1)

The FOI-5401 and FOI-5402 provides electrical isolation and extension of T1 and E1 signals. These units are ideally suited for T1/E1 trunk or backhaul, or for the extension of ISDN primary BRI, PBX, and SATCOM links. Traditional E1 cabling is limited to a maximum distance of 4,800 ft (1.46 km), but multimode optics on the unit can extend the distance to 1.2 miles (2 km), while singlemode optics can further extend the distance to 12.4 miles (20 km) or more.

- ✓ FOI-5401 1.544 Mbps (T1); FOI-5402 2.048 Mbps (E1)
- ✓ Supports ISDN PRI (primary rate interface)
- ✓ FOI-5401 passes 23B+D transparently. FOI-5402 passes 30B+D transparently
- ✓ Multimode extension of up to 1.2 miles (2 km), singlemode extension up to 12.4 miles (20 km)



FOI-5601 Series

ISDN 4-Wire S/T Fiber Extender

The FOI-5601 provides electrical isolation and the extension of 4-wire S/T interface ISDN communications. It is ideally suited for the extension of ISDN primary BRI, ISDN T interface, ISDN S bus interface, and PBX or SATCOM links. Traditional S/T cabling is limited to a maximum distance of 2,953 ft (900 m), but multimode optics on the unit can extend the distance to 1.2 miles (2 km), while singlemode optics can further extend the distance to 12.4 miles (20 km).

- ✓ Data Rate: 192 kbps
- ✓ Supports ISDN BRI (basic rate interface), also known as BRA (basic rate access)
- ✓ 2B+D data passes transparently



FOI-DSE3 Series

T3/E3 Fiber Extender

Models: FOI-DSE3 (E3) | FOI-DST3 (T3)

The FOI-DSE3 and FOI-DST3 provides electrical isolation and extension of T3 and E3 signals to SONET add/drop multiplexers, PDH equipment or WAN routers. Traditional T3/E3 coax cabling is limited to a maximum distance of 1,100 ft (335 m), but multimode optics on the unit can extend the distance to 1.2 miles (2 km), while singlemode optics can further extend the distance to 12.4 miles (20 km).

- ✓ Satisfies K41 protection requirements for T3/E3 systems
- ✓ FOI-DSE3 complies to ITU-T G.703, ITU-T G.823, ITU-T G.775 loss of signal
- ✓ FOI-DST3 complies to ANSI T1.102-1993, Telcordia GR-499-CORE, ITU-T G.775 loss of signal
- ✓ Multimode extension of up to 1.2 miles (2 km), singlemode extension up to 12.4 miles (20 km)



FOI-ST51 Series

STS-1 / OC-1 Fiber Extender

The FOI-ST51 provides electrical isolation and extension of STS-1/OC-1 signals to SONET add/drop multiplexers, PDH equipment or WAN routers. Traditional STS-1 coax cabling is limited to a maximum distance of 1,100ft (335 m), but multimode optics on the unit can extend the distance to 1.2 miles (2 km), while singlemode optics can further extend the distance to 12.4 miles (20 km).

- ✓ Satisfies K41 protection requirements for STS-1 systems
- ✓ Complies to Telcordia GR-253-CORE, ITU-T G.775 loss of signal
- ✓ Multimode extension of up to 1.2 miles (2 km), singlemode extension up to 12.4 miles (20 km)



FOI-6010 Series 12.5 Gbps Multi SFP Transceiver Workbox

Models: FOI-6010 (Single Transceiver) | FOI-6012 (Dual TX or Dual RX)

The FOI-6010 is the true “Swiss army knife” of fiber optic transport. The FOI-6010 when used with any combination of FiberPlex or third-party SFP/SFP+ optical and electrical modules, enables you to transport what you want, when you want it, how you want it, wherever you want it.

- ✓ Dual high speed 12.5 Gbps SFP/SFP+ ports
- ✓ Limitless applications
- ✓ Wide variety of FiberPlex SFPs are available (see page 47 for details)
- ✓ FOI-6010: Supports Transceiver SFP
- ✓ FOI-6010: Supports TX or Dual RX SFP



FOI-7280 Series Line Level Audio Transceiver + Serial Data & Controls

Elegantly simple yet packed with an advanced feature set, the FOI-7280 is a powerful problem solver when it comes to routing audio or transporting E&M signals. The unit converts line level, stereo analog audio to fiber for long or short haul transport. In addition to the audio, a multi-format serial data connection (RS-232/422/485) and a bidirectional pair of ‘form C’ contact closures, are included. The combination of audio and signaling provides a seamless solution for 4-wire E&M applications, push-to-talk, intercom, audio distribution, railway signaling, and more.

- ✓ Supports balanced and unbalanced audio I/O
- ✓ Supports E&M (ear and mouth) types II–V
- ✓ High quality 24-bit audio
- ✓ Ultra-wide 20 Hz to 45 kHz frequency response
- ✓ Serial data rates from 0 to 1 Mbps



RMC-2101 9-Slot 2U Chassis for Size 2 and 4 FOI Models

The RMC-2101 provides up to nine available slots for size 2 and 4 FOI devices. Slot 10 must be occupied by a PSM-2010 power supply module which is included with the chassis. An optional second PSM-2010 can be added for power redundancy, leaving eight available slots for any size 2 and size 4 FOI devices. A cable bay is provided for cable routing and enhanced air flow through two front exhaust fans.

Each FOI device must also be accompanied by a CMA-2001 chassis mount adapter, which slides the fiber optic isolator into the slot and assures correct alignment of the isolator power connector to the power bus inside the RMC-2101.

For TEMPEST or other high security applications, Patton recommends the RMC-2101R.

- ✓ Each FOI device is easily accessible through a removable front panel
- ✓ Enhanced cooling via two exhaust fans mounted in the front of the chassis



Compatible Models to RMC-2101			
FOI-2170	FOI-2980	FOI-4451	FOI-7280
FOI-2191	FOI-2990	FOI-5401	FOI-DSE3
FOI-2591	FOI-4110	FOI-5402	FOI-DST3
FOI-2890	FOI-4141	FOI-5601	FOI-ST51
FOI-2971	FOI-4341	FOI-6010	

RMC-3101 9-Slot 3U Chassis for All FOI Models

The RMC-3101 provides up to nine available slots for any FOI device or TDU-4000. Slot 10 must be occupied by a PSM-3010 power supply module which is included. An optional second PSM-3010 can be added for power redundancy, leaving eight available slots for FOI devices or TDU-4000s. A cable bay is provided for cable routing and enhanced air flow through two rear exhaust fans and a vented front panel.

An RMC-3102 is identical to the RMC-3101 with the addition of an optical patch bay mounted on the rear.

Each FOI is installed using a CMA-3002 chassis mount adapter, which slides the FOI into the slot, ensuring correct alignment inside the RMC-3101.

For TEMPEST or other high security applications Patton recommends the RMC-3101R.

- ✓ Each FOI device is easily accessible through a removable front panel
- ✓ Enhanced cooling via two exhaust fans mounted in the rear of the chassis



RMC-3700 9-Slot Wall Mount Environmental Enclosure for All FOI Models

The RMC-3700 is a heavy duty enclosure designed to survive in indoor and outdoor environments. The chassis is rated to IP-54, protecting the internal components from dust and wind-blown rain. Each chassis provides up to nine available slots for FOIs or TDU-4000s. Each RMC-3700 includes a power supply. An optional second power supply may be added for power redundancy, leaving eight available slots for FOI devices or TDU-4000s. Each FOI is installed using a 3000-series chassis mount adapter (CMA), which slides the FOI into the slot, ensuring correct alignment inside the RMC-3700.

- ✓ IP-54 rated enclosure
- ✓ Active cooling for FOI and TDU devices
- ✓ Specialty louvered vents and sealed door resist ingress of heavy and windblown rain
- ✓ Conduit holes may be punched into chassis in accordance with the customer’s needs



TD-1580 Series Multi-Standard Serial Extender, 6 Mbps

Models: TD-1580 (To DTE) | TD-1581 (To DCE)

The TD-1580 and TD-1581 pair together to form a powerful balanced serial data transport solution. The DB-25 connectors are pinned out to directly support an EIA-530 serial link. However due to the transparency and flexibility of the design, the TD-1580/81 can be used as 6x4 independent 6 Mbps RS-422 channels and 2x1 independent 256 kbps RS-232 channels (see below for details). This incredible versatility unit can be used in a myriad of serial data applications including: SCADA (supervisory control and data acquisition), telecommunications, facility automation and control, even DMX lighting control.

- ✓ Supported RS-530, 6x4 RS-422 and 1x2 RS-232
- ✓ Multimode extension of up to 1.2 miles (2 km), singlemode extension up to 12.4 miles (20 km)
- ✓ Regeneration switch on the TD-1581 allows users to toggle between sync applications requiring send timing (ST) and async/sync applications requiring terminal timing (TT)



TD-1280 Series

7 Channel RS-232 Extender, 1 Mbps

Models: TD-1280 (To DTE) | TD-1281 (To DCE)

The TD-1280 and TD-1281 offer a flexible and cost effective method for RS-232 serial data transport. The DB-25 connectors are pinned out to directly support a TIA-232 serial link. Due to the transparency and flexibility of the design, the TD-1280/81 can be used as 3x2 independent 1 Mbps TIA-232 channels and 5x5 independent 120 kbps TIA-232 channels.

- ✓ Supports rates from DC to 1 Mbps
- ✓ Multimode extension of up to 1.2 miles (2 km), singlemode extension up to 12.4 miles (20 km)
- ✓ Regeneration switch on the TD-1281 allows users to toggle between sync applications requiring send timing (ST) and async/sync applications requiring terminal timing (TT)



TD-5400 Series

T1/E1 Fiber Extender

Models: TD-5401 1.544 Mbps (T1) | TD-5402 2.048 Mbps (E1)

The TD-5401 and TD-5402 provides electrical isolation and extension of T1 and E1 signals. These units are ideally suited for T1/E1 trunk or backhaul or for the extension of ISDN Primary BRI, PBX and SATCOM links. Traditional E1 cabling is limited to a maximum distance of 4800 ft (1.46 km), but multimode optics on the unit can extend the distance to 1.2 miles (2 km), while singlemode optics can further extend the distance to 20km. .

- ✓ TD-5401 passes 23B+D transparently; TD-5402 passes 30B+D transparently
- ✓ Multimode extension of up to 1.2 miles (2 km), singlemode extension up to 12.4 miles (20 km)



TD-5601 Series

ISDN 4-Wire S/T Fiber Extender

The TD-5601 provides electrical isolation and the extension of 4-wire S/T-Interface ISDN communications. These units are ideally suited for the extension of ISDN Primary BRI, ISDN T Interface ISDN S Bus Interface and PBX or SATCOM links. Traditional S/T cabling is limited to a maximum distance of 2953 ft (900 m), but multimode optics on the unit can extend the distance to 1.2 miles (2 km), while singlemode optics can further extend the distance to 12.4 miles (20 km).

- ✓ Data Rate: 192 kbps
- ✓ Supports ISDN BRI (Basic Rate Interface), also known as BRA (Basic Rate Access)
- ✓ 2B+D data passes transparently
- ✓ Multimode extension of up to 1.2 miles (2 km), singlemode extension up to 12.4 miles (20 km)



TD-7280 Series

Line Level Audio Transceiver + Serial Data & Controls (4-wire E&M)

Elegantly simple yet packed with an advanced feature set, the TD-7280 is a powerful problem solver when it comes to routing audio or transporting E&M signals. The unit converts line level, stereo analog audio to fiber for long or short haul transport. In addition to the audio, a multi-format serial data connection (RS-232/422/485) and a bi-directional pair of 'Form C' contact closures, are included. The combination of audio and signaling provides a seamless solution for 4-wire E&M applications, push to talk, intercom, audio distribution, railway signaling and more.

- ✓ Supports Balanced and Unbalanced Audio I/O
- ✓ Supports E&M (Ear and Mouth) Types II-V
- ✓ High Quality 24-bit audio
- ✓ Ultra-wide 20 Hz to 45 kHz Frequency Response
- ✓ Serial Data Rates from 0 to 1 Mbps



TD-7282 Series

2-Wire Audio Transceiver + Serial Data & Controls (2-wire E&M)

The TD-7282 is an innovative fiber conversion unit which allows for the creation of point-to-point or daisy chained connections utilizing your current inventory of 2-wire party-line intercom systems such as RTS and ClearCom. The unit converts 2-wire duplex analog audio to fiber for long or short haul transport. In addition to the audio, a multi-format serial data connection (RS-232/422/485) and a bidirectional pair of 'Form C' contact closures are included. The combination of audio and signaling also provides a seamless solution for 2-wire E&M applications.

- ✓ Supports 2-Wire Full and Half Duplex Audio I/O
- ✓ Supports Ultrasonic, RTS™ and ClearCom™ signaling
- ✓ High Quality 24-bit audio
- ✓ Point-to-Point, Broadcast, Intercom/Loop and Multichannel Add/Drop topologies supported
- ✓ Serial Data Rates from 0 to 1 Mbps



TD-6010 Series

12.5 Gbps Multi SFP Workbox

Models: TD-6010 (Single Transceiver) | TD-6012 (Dual TX or Dual RX)

The TD-6010 series is the true "Swiss army knife" of fiber optic transport. The FOI-6010 series, along with any combination of FiberPlex of third-party SFP/SFP+ optical & electrical modules, enables you to transport what you want, when you want it, how you want it, wherever you want it. The TD-6012 allows for dual transmit or dual receive SFP/SFP+ modules.

- ✓ Dual high speed 12.5 Gbps SFP/SFP+ ports
- ✓ Wide variety of FiberPlex SFPs are available (see page 47 for details)
- ✓ TD-6010: Supports Transceiver SFP
- ✓ TD-6010: Supports TX or Dual RX SFP



TIS-8632

6-Port 10/100/1000 Unmanaged Ethernet Switch

Elegantly simple yet packed with an advanced feature set, the TIS-8632 is a powerful 6-port 10/100/1000 Ethernet switch. The unit features (4) RJ-45 UTP ports as well as (2) flexible SFP ports. Two or more TIS-8632 can be chained together via fiber to provide a distributed solution where isolation, distance, security and/or noise immunity is needed between nodes.

- ✓ Flow control for full duplex and half duplex
- ✓ Supports up to 10k byte JUMBO frame
- ✓ Supports ports based VLANs and TAG based VLANs



TNE-03

NEMA 4x Rated Enclosure for TD Series

Harsh industrial problems require rugged solutions. The TNE-03 provides power and environmental protection for up to 3 TD Series devices. Convenient DIN rail mounting provides a simple and easy installation for TD Series modules when used with the TD-DINR DIN rail adapters. An 18W 12V power supply comes standard. For light pole installations and other applications where industrial lighting voltage (eg 277 VAC) is available, the TNE-03-T includes a 208/277/380 VAC step-down transformer pre-installed. The enclosure carries a full NEMA 4x rating and is ready to be punched to accommodate your connectivity needs. Environmentally sealed conduit connectors must be used to maintain seal.

- ✓ NEMA 4x rated (IP66)
- ✓ Fits 3 TD models or 1 TIS model (double-wide TD) plus 1 standard TD
- ✓ DIN rail power supply included
- ✓ Optional step-down transformer accepts 208/277/380 VAC industrial power



TKIT-3G

3G SDI Video Fiber Extender Kit

The TKIT-3G is a pair 3G SDI Video Fiber Extenders. The TKIT-3G extenders are equipped with a long-reach electrical SFP transceiver modules designed with reclockers to transmit and receive SDI signals up to 2.97 Gbps over 75Ω coaxial cables via HD-BNC™ connectors. The cable driver slew rate is automatically configured in order to achieve compliance to SMPTE 424M, SMPTE 292M and SMPTE 259M. The equalizer features DC restoration to compensate for the DC content of SMPTE pathological test patterns. By suppressing accumulated jitter, each reclocker procures optimal input & output jitter performance.

- ✓ SMPTE 424M, 344M, 292M and 259M compliant
- ✓ Supports DVB-ASI at 270 Mbps
- ✓ Supports video pathological patterns SD-SDI, HD-SDI and 3G-SDI



TKIT-DANTE

DANTE & AVB Fiber Extender Kit

The TKIT-DANTE is a pair of fiber extenders support multichannel audio using the DANTE protocol. One unit at each end of a pair of fiber accepts either a 100 Mbps or 1 Gbps DANTE connection. The resulting link will extend the usable distance from just 300 meters to up to 12.4 miles (20 km) maintaining near-zero latency and synchronization.

- ✓ Up to 1.25 Gbps bi-directional data links



TKIT-ETH

10/100/1000Base-T Fiber Extender Kit

The TKIT-ETH is a pair of fiber extenders supporting the transparent extension of Ethernet. The resulting link will extend the usable distance from just 100 meters (328 feet) to 1.2 miles (2 km) and up to 12.4 miles (20 km) over singlemode fiber maintaining near-zero latency.

- ✓ Up to 1.25 Gbps bi-directional data links



TKIT-HDMI

HDMI Video Fiber Extender Kit

The TKIT-HDMI is a pair of fiber extenders will extend HDMI/DVI (High definition multimedia interface®) to over fiber without the introduction of scaling artifacts. The TKIT-HDMI enforces HDCP, therefore the units will not pass protected content. Up to 8 channels of audio are supported and de-embedded from the HDMI signal.

- ✓ SMPTE 424M, 292M and 259M compliant
- ✓ Supported formats 25/625, 720p/1080i (50/59.94/60Hz), 1080p (23.98/24/15/29.97/30/50/59.95/60 Hz)



TKIT-MADI

AES-10 (MADI) Fiber Extender Kit

The TKIT-MADI fiber extender kit transports 125 Mbps MADI signals over fiber. The cable driver amplitude and edge rate are automatically configured in order to achieve compliance to AES10-2003.

- ✓ MADI presented over HD-BNC™ 75Ω coax
- ✓ Available as Transceiver, Dual RX or Dual TX
- ✓ Integrated equalizer



TKIT-SD

SDI-Analog Composite Video Fiber Extender Kit

The TKIT-SD fiber extender kit extends SDI-Analog composite video over fiber. The kit encodes and decodes composite signals over 75Ω coaxial cables via HD-BNC™ connectors. On the receive channel, the module decodes NTSC/PAL composite inputs and convert to SD-SDI signal. On the transmit channel, the module encodes the SD-SDI signal to NTSC/PAL composite.

- ✓ SDI-Analog presented over HD-BNC™ 75Ω coax
- ✓ SMPTE 259M-C compliant
- ✓ Supports composite standards: NTSC M, NTSC J, NTSC 4.43; PAL B/G/H/I/D, PAL M, PAL N, PAL 60



TKIT-MODE

Multimode to Singlemode Converter

The TKIT-MODE unmanaged multimode to singlemode converters allow you to protect the investment of both your legacy fiber plant and/or equipment. These converters are available in 155 Mbps, 1.25 Gbps, and 50 Mbps to 3 Gbps.

- ✓ Preserve the life of your fiber equipment and/or fiber plant
- ✓ No configuration required



TKIT-RPTR

3G-SDI HD Video SFP

The TKIT-RPTR allows you to extend the distance of your cable plant by re-driving the optical signal. Both singlemode and multimode options are available in a selection of speeds. The standard offering is 155 Mbps, 1.25 Gbps, and 50 Mbps to 3 Gbps. If you have a specific need that is not listed, any of the optical SFPs that we offer can be used à la carte in a TD-6010.

- ✓ Extend the distance of your cable plant by re-driving optical power
- ✓ Available in singlemode or multimode



SFP-BA10 Series

MADI (AES10-2003 Compliant) SFP

The SFP-BA10XC-0000-M is a medium reach electrical transceiver module designed to transmit and receive MADI signals up to 125 Mbps over 75Ω coaxial cables via HD-BNC™ connectors. The cable driver amplitude and edge rate are automatically configured in order to achieve compliance to AES10-2003.

- ✓ Available as Transceiver, Dual RX or Dual TX
- ✓ Integrated equalizer
- ✓ Integrated cable driver (control input signal detection, voltage & temp, and module info)



SFP-BHDV Series

3G-SDI HD Video SFP

The SFP-BHDVXC-0000-L is a long-reach electrical Small Form Pluggable (SFP) transceiver module designed with reclockers to transmit and receive SDI signals up to 2.97 Gbps over 75Ω coaxial cables via HD-BNC™ connectors. The cable driver slew rate is automatically configured in order to achieve compliance to SMPTE 424M, SMPTE 292M and SMPTE 259M. The equalizer features DC restoration to compensate for the DC content of SMPTE pathological test patterns. By suppressing accumulated jitter, each reclocker procures optimal input and output jitter performance.

- ✓ SMPTE 424M, 344M, 292M and 259M compliant
- ✓ Supports DVB-ASI at 270 Mbps
- ✓ Supports video pathological patterns SD-SDI, HD-SDI and 3G-SDI
- ✓ Integrated cable driver (control input signal detection, reclocker rate & lock, voltage and temp, bypass reclocker stage and module info)



SFP-BSDV Series

SD-SDI Analog Composite Video SFP

The SFP-BSDV is series of electrical transceiver SFP designed to encode and decode composite signals over 75Ω coaxial cables via HD-BNC™ connectors. On the receive channel, the module decodes NTSC/PAL composite inputs and convert to SD-SDI signal. On the transmit channel, the module encodes the SD-SDI signal to NTSC/PAL composite.

- ✓ SMPTE 259M-C compliant
- ✓ Supports composite standards: NTSC M, NTSC J, NTSC 4.43; PAL B/G/H/I/D, PAL M, PAL N, PAL 60
- ✓ Integrated cable driver (analog status and control registers, voltage and temp, and module info)



SFP-HHDV Series

HDMI 1.4 HD Video Transmitter/Receiver SFP

The SFP-HHDV is a series of electrical transmitter and receiver SFPs designed to convert HDMI/DVI (High definition multimedia interface) to an SDI signal output without scaling artifacts. The SFP-HHDV enforces HDCP, therefore the unit will not pass protected content. Up to 8 channel of audio is supported and de-embedded from the HDMI signal.

- ✓ SMPTE 424M, 292M and 259M compliant
- ✓ Supported formats 25/625, 720p/1080i (50/59.94/60Hz), 1080p (23.98/24/15/29.97/30/50/59.95/60 Hz)
- ✓ Integrated cable driver (HDMI/DVI interface config, EDID reading, audio mapping, voltage and temp, and module info)



SFP-OC Series

Optical Data SFP

These SFPs support data centric applications at a variety of data rates and distances. They are designed for digital data applications and are not recommended for digital video applications due to SMPTE encoding that may cause pathological signal errors. For video applications see our line of Video Optimized SFP Modules (SFP video).

- ✓ Duplex LC connector
- ✓ Hot-pluggable SFP footprint
- ✓ RoHS compliant and Lead Free



SFP Video Series

Optical Video SFP

These video-optimized optical SFP modules transmit optical serial digital signals as defined in SMPTE 297-2006. They are designed for error-free performance in the presence of SDI pathological patterns across the entire range of supported data rates. Very high sensitivity and expanded optical power output make these SFPs highly reliable, even in the most complex of cable plant applications. While they are optimized for maximum video performance, they can also be used for standard data and telecom applications. For data and telecom-only applications, see our line of Data SFP Modules (SFP-OC).

- ✓ Available in SFP MSA SFF-8074i compliant and SMPTE Non-MSA compliant versions
- ✓ SMPTE 424M, 344M, 292M and 259M compliant
- ✓ Supports DVB-ASI at 270 Mbps
- ✓ Integrated cable driver (control input signal detection, reclocker rate & lock, voltage and temp, bypass reclocker stage and module info)



SFP-RT Series

Copper Ethernet SFP

The SFP-RT series are high performance Copper SFP transceivers are Gigabit Ethernet and 10/100/1000Base-T compliant, supporting 1000 Mbps data-rate up to 328 feet (100 meters) reach over unshielded twisted-pair CAT 5 cable.

- ✓ Up to 1.25 Gbps bi-directional data links
- ✓ 1000Base-T operation in host systems with SERDES interface
- ✓ 10/100/1000 Mbps compliant in host systems with SGMII interface



FOM-9010 Series

Control Signal & Relay Contacts Fiber Mux

Models: FOM-9010 (12 channel; contact closure or voltage) | FOM-9011 (8 channel; Form C solid) | FOM-9012 (12 channel; SPST Form A or B contact closure)

FOM-9010, FOM-9011, and FOM-9012 provide uni-directional transport of low-level control or contact status signals. The status of all signals is shown on front panel indicators in addition to power supply and optical link status for each card.

The FOM-9010 can be used with contact closure sense or voltage inputs. The voltage input mode will accept polarity sensitive TIA-232, TTL, or TIA-422 state indications as well as sensing AC or DC voltages for simple presence. Note that while the unit accepts some electrical data standards, but any data activity is simply viewed as an AC voltage and will be identified as being 'on'.

- ✓ 12 individually configurable channels
- ✓ Voltage sense, open collector or contact inputs
- ✓ The FOM-9011 NC contact remains shorted to the C contact even with the FOM powered off.
- ✓ 8 channels fixed as Form C solid state contacts
- ✓ SPDT Form C (change over) latching contact closures
- ✓ The FOM-9012 supports Form A or B solid state contacts on the output channels. Form B contacts remain shorted even when the FOM is powered off.
- ✓ 12 individually configurable channels
- ✓ SPST Form A (normally open) or Form B (normally closed) latching contact closures



FOM-5600 Series

ISDN Fiber MUX, 4 Channel

Provides electrical-to-optical conversions and extension of 4-wire ISDN S/T interface signals. The unit has four channels that are independent of each other with two switches each that allow users to select between different ISDN modes and interfaces. Supports rates up to 192 kbps

- ✓ Supports ISDN BRI (Basic Rate Interface)
- ✓ Each channel can be retimed to allow for longer S/T runs
- ✓ Multimode extension of up to 1.2 miles (2 km); singlemode extension up to 50 miles (80 km)



FOM-5400 Series

T1/E1 Fiber MUX, 4 Channel

The FOM-5400 is a 4 channel multiplexer that provides electrical-to-optical conversions and extension of T1 or E1 signals. It has four RJ-48C ports and one fiber optic transceiver. The card passes all alternate mark inversion (AMI) signaling regardless of the specific line encoding, making it transparent to handshaking protocols or standards. Each channel is independent and can be operated at different data rates.

- ✓ Auto-Detects TX/RX on RJ-48C ports; use straight through or cross-over cables
- ✓ Supports ISDN PRI (Primary Rate Interface)
- ✓ Multimode extension of up to 1.2 miles (2 km), singlemode extension up to 50 miles (80 km)



FOM-3840 Series POTS Fiber Converter, 4 Channel

Models: FOM-3841 (to Line) | FOM-3842 (to Device)

The FOM-3841 and FOM-3842 provide complete electrical isolation for four independent channels of 2-wire telephone communications. FOM-3841 connects to the POTS (plain old telephone service) line while the FOM-3842 connects directly into standard analog phones or modems. The FOM-3842 is also compatible with STU-III (secure telephone unit) phones, STE (secure telephone equipment) phones, fax machines, and modems.

- ✓ Caller ID supported
- ✓ FOM-3842s can be used back-to-back for a private-line automatic-ringdown circuit.

FOM-1090 Series Multi-Standard Serial Interface, 25 Mbps

Models: FOM-1090 (to DCE) | FOM-1091 (to DTE)

The FOM-1090 and FOM-1091 fiber optic isolator/modem cards provide for full synchronous, asynchronous, or isochronous interfacing to serial data communications equipment. The units are transparent to all data formats and protocol, and support timing from the DCE and DTE as well as uncommon clocking styles such as gapped clock or gated clocks that stop in different states to indicate status. The status and direction of all supported signals is shown on front panel indicators in addition to power supply and optical link status for each card.

- ✓ Synchronous, asynchronous, Isochronous signal rates: DC to 20 MHz
- ✓ Tail circuit and null modem functions for DCE to DCE or DTE to DTE
- ✓ Supported interface standards: TIA-232, TIA-530/530A, TIA-574, TIA-449, V.35 and X.21
- ✓ Supported electrical standards: TIA-411/V.11/FED-STD-1030A, TIA-423/V.10/FED-STD-1020A, TIA-232/V.28, V.35, MIL-STD-100, MIL-STD-188-114A Balanced types 1&2 (V.11 mode) and MIL-STD-188-114A unbalanced (V.10 mode)

SAC-1 Single Card 1U Chassis for FOM Series

The SAC-1 is a standalone FOM card chassis, providing power, enclosure and secure mounting for a single Fiber Optic Module. Each SAC-1 may be rack, wall or desktop mounted using the included mounting system.

- ✓ Desktop, wall mount, rack mount and dual side-by-side rack mount configurations available
- ✓ Each FOM is accessible and removable through rear of the chassis
- ✓ Available with integrated AC or DC power supply

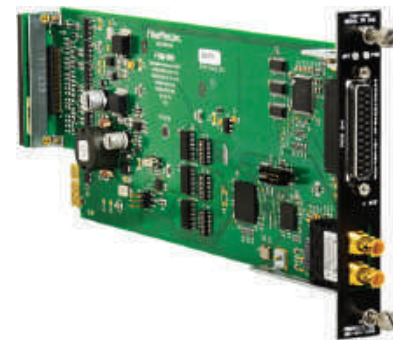

RMC-5000 16 Card 4U Chassis for FOM Series

The RMC-5000 rack mount chassis provides up to sixteen available slots for any FOM series fiber optic module card. The FOM cards are typically installed from the rear of the chassis, providing electrical and fiber optic connections at the rear of the chassis. A front panel window allows viewing of status leds on each installed card indicating power supply status, fiber optic link status, signal line status, and control or configuration information, depending on the particular card. The chassis backplane allows various support modules to be installed, allowing for future expansion and control options. No active components are an integral part of the chassis backplane, providing high reliability and minimal maintenance issues.

- ✓ Redundant power (optional)
- ✓ Chassis cooled with front and rear exhausted fan
- ✓ Visual and audible monitoring of power supply status



WDM16 16-Channel Active Wavelength Division Multiplexer

The WDM16 enables a user to combine up to 16 sources of data on a single fiber pair. Each channel can be linked via fiber with selected FiberPlex FOM, FOI or TD Series fiber modules, FiberPlex LightViper™ or with virtually any third-party fiber optic equipment with data rates from 155 megabits up to 3 gigabits per channel, for a possible maximum aggregate data rate of 48 Gbps. Alternately, the WDM16 can be combined with our vast selection of copper SFP modules for HD video, Ethernet, audio, and more over a single fiber pair.

- ✓ Each channel independently supports data rates from 155 Mbps to 3 Gbps
- ✓ SMPTE compatible internal fiber optics, video optimized to support pathological signals
- ✓ Each optic channel can independently accept singlemode or multimode optics, coax, or CAT5 SFP modules



WDM8 8-Channel Active Wavelength Division Multiplexer

The WDM8 enables a user to combine up to 8 sources of data on a single fiber pair. Each channel can be linked via fiber with FiberPlex FOM, FOI or TD modules, FiberPlex LightViper™ or with virtually any third-party fiber optic equipment with data rates from 155 megabits up to 3 gigabits per channel, for a maximum aggregate data rate of 24 Gbps. Alternately, the WDM8 can be combined with our copper SFP modules for HD video, Ethernet, audio and more over a single fiber pair. The WDM8A supports 1470 to 1610 nm; the WDM8B supports 1310 to 1450 nm.

- ✓ Each channel independently supports data rates from 155 Mbps to 3 Gbps
- ✓ SMPTE compatible internal fiber optics, video optimized to support Pathological Signals
- ✓ Each optic channel can independently accept singlemode or multimode optics, coax, or CAT5 SFP modules



WDP16 16-Channel Passive Wavelength Division Multiplexer

The WDP16 is a rack-mountable passive 16-channel coarse wavelength division multiplexer. Unlike the similar products in the WDM series, this unit is passive, and all connected fiber optic modules must be externally selected to specific wavelengths. Being a passive unit, the WDP16 requires no external power and occupies a smaller 1U rack space. Fiber optic inputs and outputs are connected via singlemode duplex LC/PC mating sleeves in the rear of the unit.



- ✓ Each channel has virtually unlimited bandwidth
- ✓ Supports both digital and analog optical signals
- ✓ Passive nature means higher reliability
- ✓ Mux & De-Mux in one package

WDP8 8-Channel Passive Wavelength Division Multiplexer

The WDP8 is a rack-mountable passive 8-channel coarse wavelength division multiplexer. Unlike similar products in the WDM series, this unit is passive, and all connected fiber optic modules must be externally selected to specific wavelengths. Being a passive unit, the WDP8 requires no external power and occupies a smaller 1U rack space. Fiber optic inputs and outputs are connected via singlemode duplex LC/PC mating sleeves in the rear of the unit. The WDP8A supports wavelengths of 1471 to 1611 nm, and the WDP8B supports wavelengths of 1311 to 1451 nm.



- ✓ Each channel has virtually unlimited bandwidth
- ✓ Supports both digital and analog optical signals
- ✓ Passive nature means higher reliability
- ✓ Mux & De-Mux in one package

TD-OADM Series Optical Add/Drop Multiplexer

TD-OADMs are a cost effective method for removing and rerouting individual wavelengths from your main fiber trunk to specific destinations.

The TD-OADM is an optical add/drop mux used in WDM (wavelength-division multiplexing) systems for multiplexing and routing different channels of light into or out of a single mode fiber (SMF). A dedicated wavelength is assigned to any kind of voice, video or network traffic.

These channels are completely transparent to traffic type, protocols and compression schemes. TD-OADMs are commonly used in point-to-point, linear, ring, star, and mesh topologies for a large variety of applications.



WGF Series Waveguide Feedthrough

Models: WGF-12 (12 bores) | WGF-6 (6 bores) | WGF-461 (6 bores MIL-461) | WGF-4 (4 bores)

The WGF series has 4, 6, or 12 bores that can accept numerous fiber optic cables with attached connectors. Waveguides enable bringing fiber optic cables into a shielded enclosure or SCIF (Sensitive Compartmented Information Facility) while maintaining the enclosure's or SCIF's radio frequency isolation integrity. The filter has a patented removable center plug, around which are 6 or 12 waveguide

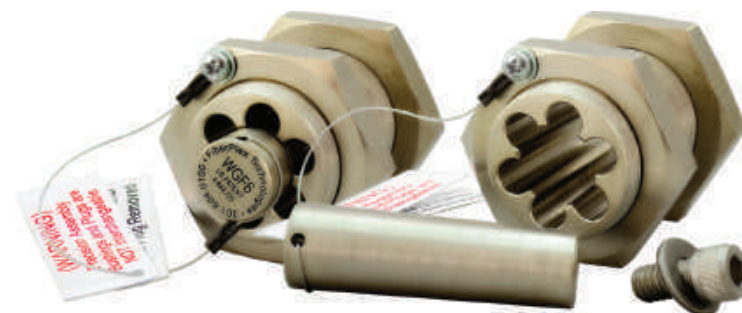

bores. When the center plug is removed, pre-terminated fiber optic cables can be inserted into the peripheral cable sized slots. Waveguide extension tubs and nuts (WET, WEB, and WEN) are available for installations that are too thick for the WGF to go through.

- WGF-12, WGF-6 and WGF-461 exceed NSA 65-6 shielding specifications
- WGF-12, WGF-6 and WGF-461 have patented removable plugs to allow easy pass-through of pre-terminated cable
- WGF-461 meets MIL-461 EMC specification

WEN Series

FiberPlex WGF series of waveguide filters provide a way of bringing pre-terminated fiber optic cables into a shielded enclosure while maintaining the enclosure's radio frequency isolation integrity. The diameter and length of the bore are precisely calculated to provide a measured attenuation at a specific cutoff frequency. This works extremely well, however occasionally the wall of the shielded enclosure, SCIF or chamber that needs to be penetrated is thicker than the calculated length of the waveguide filter.

Previously this length limitation has been overcome with the combination of a brass waveguide extension tube and a coupling nut. This solution works perfectly and can accommodate even very thick walls, however it does create a protrusion on either side of the wall that could be at best unsightly and at worst a safety hazard. The WEN-6 solves this problem by providing an extension solution that maintains the mathematically calculated dimensions of the waveguide while creating a flush mounting solution.

- ✓ Extends the length of a FiberPlex waveguide
- ✓ Creates a clean flush-mount solution
- ✓ Simple installation

Waveguides Extension Nut



WET | WEB Series

Models: WEB (brass) | WET (PVC)

The WEB and WET extension tubes allow for easier pass-through of fiber through thick walls and penetrations.

WEB tubes are made of brass and have external threads that match the WGF-6, WGF-461 and WGF-4. They require a WCN-6 Waveguide Coupling Nut to attach them to the waveguide filter.

The WET tubes are made of PVC and are internally threaded. These attach directly to the Waveguide filters without the need for a separate coupling nut. The WET-18-A fits the WGF-6, WGF-461 and WGF-4. The WET-18-B fits the WGF-12.

- ✓ Extensions tubes for WGF (waveguide filters)
- ✓ Allows for easier fiber feed through thick walls

Waveguides Extension Tubes

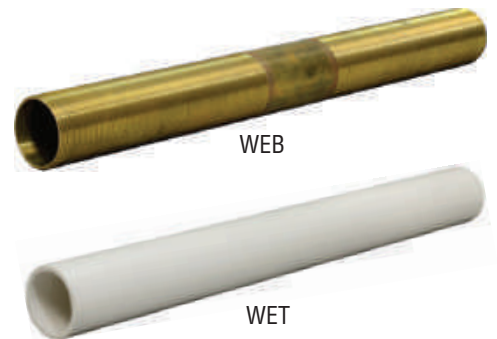

WGN | WCN Series

Models: WGN (Nut) | WCN (Coupling Nut)

The WGN-6 is a spare nut for the WGF-6, WGF-461 and WGF-4. The WGN-12 is a spare nut for the WGF-12. The WCN-6 is a brass coupling nut for use with a WEB brass Waveguide Extension Tube (WEB-6, WEB12).

Waveguide Standard & Coupling Nuts



VIM-1808 Series **8x8 Audio Tie Line**

Models: VIM-1808 (clock master) | VIM-0808 (clock slave)

The LightViper® VIM-1808 and VIM-0808 combine to create a powerful 8x8 audio tie line system. Each unit features 8 audio inputs and outputs which are selectable between analog line level and AES3 digital.

The VIM-1808 is the clock master in the system with the ability to generate its own superior quality Word Clock, or alternately accept an external Word Clock. There can be only one VIM-1808 in any given system. The VIM-0808 is a clock slave and requires a VIM-1808 to operate. It has clock output for synchronizing external equipment and for distribution of clock.

The system features a “control” connection which is a TTL data port which appears on an EtherCon® connector. It allows LightViper accessory devices such as the DMX4o (DMX lighting control) or MD3 (RS-422/232/MIDI) to be connected to the unit.

- ✓ Pass-through TX optical connector for lossless signal and daisy chaining for audio distribution applications.
- ✓ 8 simultaneous analog and digital outputs
- ✓ 24-bit 48k or 96k operation
- ✓ Optical distribution of Word Clock



VIM-1832 Series **8x32 Audio Distribution Tail**

Models: VIM-1832 (clock master) | VIM-1032 (clock slave)

The LightViper® VIM-1832 is used in connection with the VRK-1832 (analog) or VIS-4832 (digital) to achieve a 32x8 fiber-optic transport system. This VIM-1832 is normally the “tail” end for Stage to FOH or drive snake applications and the VIM-1032 serves as a split of the 32 incoming channels for the monitor location or other audio distribution points. The VIM-1832 and optional VIM-1032 combine with either a VRK-1832 (analog) or VIS-4832 (digital) to create a powerful 32x8 audio distribution system. The VIM-1832 features 8 audio inputs and 32 audio outputs which are selectable between analog line level and AES3 digital.

The VIM-1832 is the clock master in the system. It has the ability to generate its own superior quality Word Clock, or alternately accept an external Word Clock. There can be only one VIM-1832 in a given system. The VIM-1032 is a clock slave and requires a VIM-1832 to operate. It has clock output for synchronizing external equipment and for distribution of clock.

The system features a “control” connection which is a TTL data port which appears on an EtherCon® connector. It allows LightViper accessory devices such as the DMX4o (DMX lighting control) or MD3 (RS-422/232/MIDI) to be connected to the unit.

- ✓ Pass through TX optical connector for lossless signal and daisy chaining for audio distribution applications.
- ✓ 32 simultaneous analog and digital outputs
- ✓ 24-bit 48k or 96k operation
- ✓ Optical distribution of Word Clock



VRK-1832 **5U, 32x8 Analog Head**

The LightViper® VRK-1832 is used in connection with the VIM-1832 cards to achieve a 32x8 fiber-optic transport system. The VRK-1832 is the “head” end for stage to front of house (FOH) or drive snake applications.

The VRK-1832 contains 32 mic/line inputs (sends) and 8 analog line level outputs (returns). A 3-position gain switch for each input sets the gain of the mic-pre. Settings for these switches are: 0 = line level, 26 = mic level, 12 = high transient/very “hot” mic level. There are 4 +48v Phantom power on/off switches with LED indicators. Phantom power is applied in groups of 8 inputs.

The VRK-1832 is supplied with a pair of transmit/receive LC fiber connectors (other connector types possible). Two optical splits come standard. These splits (transmit only) are presented on a single fiber each. The VIS-1832 will operate at 48k or 96k sampling rate.

The system features a “control” connection which is a TTL data port which appears on an EtherCon® connector. It allows LightViper accessory devices such as the DMX4o (DMX lighting control) or MD3 (RS-422/232/MIDI) to be connected to the unit.

- ✓ 32 mic/line inputs with a 3-position gain switch
- ✓ 24-bit 48k or 96k operation
- ✓ Ultra-low-latency cable runs over 1.2 miles (2 km) on multimode or 12.4 miles (20 km) on singlemode with no loss



VIS-4832 **1vU, 32x8 Analog Head**

The VIS-4832 is used with the VIM-1832 to achieve a 32x8 fiber-optic transport system. The VIS-4832 / VRK-1832 is used as a transport for STAGE to FOH with or without splits, using other manufacturers’ digital mic-pre’s input to the VIS-4832. This VIS-4832 / VIM-1832 system can also be used as a 32 channel drive snake.

This device contains 32 AES digital inputs and 8 analog OR 8 digital outputs (returns). There are word clock & super clock outputs presented on BNC connectors. The VIS-4832 is supplied with a pair of transmit/ receive LC fiber connectors (other connector types possible). 2 fiber optic splits are available as an option. These splits (transmit only) are presented on single LC connectors. The VIS-4832 will operate at 48k or 96k There are “sync” status LEDs on the front and rear panels of the unit.

The “control” connection is a TTL data port which appears on an EtherCon® connector. It allows LightViper accessory devices such as the DMX4o (DMX lighting control) or MD3 (RS-422/232/MIDI) to be connected to the unit. The EtherCon® output of the DMX4i or RJ-45 on the MD-3 is input to the VIM-1832 via the “control” EtherCon® connector, combined with the audio input data, and transported via fiber to the VIS-4832. This data is then output from the “control” EtherCon® connector on the VIS-4832 and input into a DMXo or MD-3, where the TTL data is translated back into the original format. The VIS-4832 is convection cooled. AC power is via standard IEC connector. The unit can operate at any voltage 50–60Hz, 90–250 VAC.

- ✓ 32 AES3 digital inputs
- ✓ 24-bit 48k or 96k operation
- ✓ Optical distribution of Word Clock





Industrial Communication Products Ltd
Tel: +44 (0) 203 086 9569

Web: www.industrialcomms.co.uk
E-mail: sales@industrialcomms.com

www.patton.com

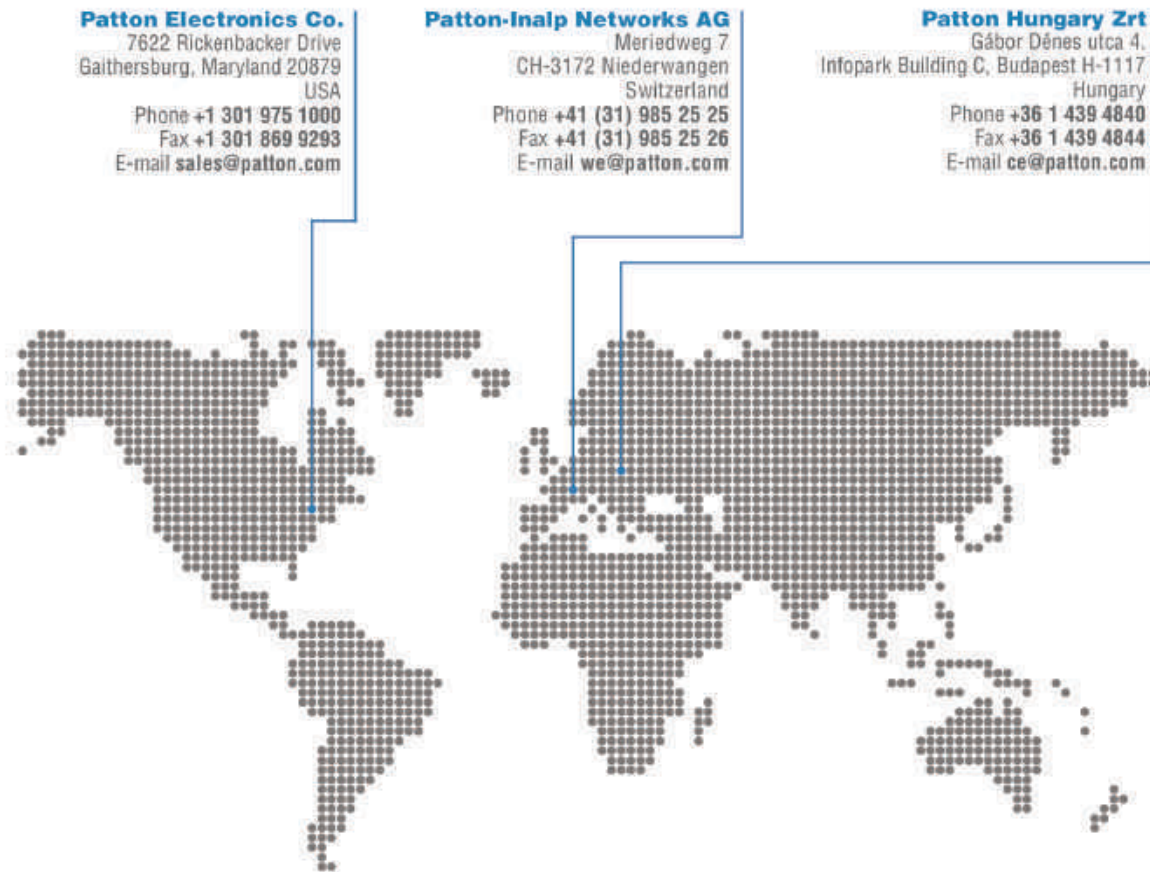

Patton Electronics Co.
7622 Rickenbacker Drive
Gaithersburg, Maryland 20879
USA
Phone +1 301 975 1000
Fax +1 301 869 9293
E-mail sales@patton.com

Patton-Inalp Networks AG
Meriedweg 7
CH-3172 Niederwangen
Switzerland
Phone +41 (31) 985 25 25
Fax +41 (31) 985 25 26
E-mail we@patton.com

Patton Hungary Zrt
Gábor Dénes utca 4.
Infopark Building C, Budapest H-1117
Hungary
Phone +36 1 439 4840
Fax +36 1 439 4844
E-mail ce@patton.com

PATTON
Let's Connect!