

FiberPlex 1004E

6 Port 10/100/1000 Light Industrial Ethernet Switch

User Manual



This is a Class A device and is not intended for use in a residential environment.

Sales Office: +1 (301) 975-1000
Technical Support: +1 (301) 975-1007
E-mail: support@patton.com
WWW: www.patton.com

Part Number: 50000025, Rev. A
Revised: September 30, 2019

Patton Electronics Company, Inc.

7622 Rickenbacker Drive
Gaithersburg, MD 20879 USA
tel: +1 (301) 975-1000
fax: +1 (301) 869-9293
support: +1 (301) 975-1007
web: www.patton.com
e-mail: support@patton.com

Trademark Statement

Patton is a registered trademark of Patton Electronics Company in the United States and other countries. The term *FiberPlex* is a trademark licensed to Patton Electronics Company.

Copyright © 2019, Patton Electronics Company. All rights reserved.

The information in this document is subject to change without notice. Patton Electronics assumes no liability for errors that may appear in this document.

Disclaimer

The information in this document has been carefully checked and is believed to be accurate at the time of publication. However, no liability is assumed by Patton for inaccuracies, errors, or omissions, nor for loss or damage resulting either directly or indirectly from use of the information contained herein.

Warranty Information

Patton Electronics warrants all FiberPlex Ethernet Switch components to be free from defects, and will—at our option—repair or replace the product should it fail within one year from the first date of the shipment.

This warranty is limited to defects in workmanship or materials, and does not cover customer damage, abuse or unauthorized modification. If the product fails to perform as warranted, your sole recourse shall be repair or replacement as described above. Under no condition shall Patton Electronics be liable for any damages incurred by the use of this product. These damages include, but are not limited to, the following: lost profits, lost savings and incidental or consequential damages arising from the use of or inability to use this product. Patton Electronics specifically disclaims all other warranties, expressed or implied, and the installation or use of this product shall be deemed an acceptance of these terms by the user.

Summary Table of Contents

- 1 General information 12
- 2 Installation 19
- 3 Contacting Patton for Assistance 29
- A Compliance Information 33
- B Specifications 36

Table of Contents

About this guide.....	8
Audience.....	8
Structure.....	8
Precautions	9
For your protection	9
Safety when working with electricity.....	10
General observations	10
1 General information	12
FiberPlex 1004E Overview	13
Features.....	14
Standard Ordering Options.....	14
Applications	14
Remote Network application	15
Distributed Wi-Fi application	15
Distributed IP video application	15
Secure Conference Room application	16
FiberPlex 1004E Front	16
FiberPlex 1004E Rear.....	18
2 Installation	19
Introduction.....	20
Initial Inspection	20
Unpacking.....	20
Disposal of Packing Materials	20
Choosing the Installation Site.....	20
Ambient Temperature	20
Grounding and Power Supply	21
Power Requirements and Mounting.....	21
Redundant Power	21
Standalone	21
Surface Mount	21
DIN Rail	22
Tray Mounting	23
Inserting and Removing SFP Modules.....	24
Identifying the Latch Type of the SFP Module	25
Inserting a Module	25
Removing a Module	26
Additional Information	27
Bonding Units	27
SFP MSA Compliance	27

3	Contacting Patton for Assistance	29
	Introduction	30
	Contact information	30
	Online Support	30
	Contacting Patton Technical Services for Free Support	30
	Warranty Service and Returned Merchandise Authorizations (RMAs)	30
	Warranty coverage	31
	RMA numbers	31
	Disposal of Used Equipment	32
A	Compliance Information	33
	Regulatory Information	34
	EMC Directive:	34
	Low-Voltage Directive (Safety):	34
	PSTN:	34
	Radio and TV Interference (FCC Part 15)	34
	CE Declaration of Conformity	34
	Authorized European Representative	35
	Service	35
B	Specifications	36
	Supported Standards	37
	Electrical Specifications	37
	Optical Specifications	38
	Physical Specifications	38

List of Figures

1	FP1004E Front	13
2	FP1004E Rear	13
3	1U TDR-01 rack shelf with FP1004E units installed	14
4	Remote Network application	15
5	Distributed Wi-Fi application	15
6	Distributed IP video application	15
7	Secure Conference Room application	16
8	FP1004E front panel LEDs, ports, and switches	16
9	FP1004E rear panel ports	18
10	FP1004E Surface Mount	22
11	FP1004E installation on a TD-DINR	23
12	FP1004E installation on a TDR-01-AC tray	24
13	Inserting a Module	25
14	Releasing the latching mechanism	26
15	Releasing the slide tab	26
16	Removing a module	27
17	Representative Drawing of an SFP Passive Cable Assembly	27
18	FP1004E Dimensions	38

List of Tables

1	Front panel ports, LEDs, and switches	17
2	Rear panel ports	18
3	Pinout Comparison Chart	28
4	Copper UTP RJ-45 Interface	37
5	Optical SFP Interface	37

About this guide

This guide describes the FiberPlex 1004E 6-Port 10/100/1000 Light Industrial Ethernet Switch hardware installation.

Audience

This guide is intended for the following users:

- Installers
- Maintenance technicians

Structure

This guide contains the following chapters and appendices:

- [Chapter 1](#), starting on page 12, provides information about switch features and capabilities
- [Chapter 2](#), starting on page 19, provides installation procedures
- [Chapter 3](#), starting on page 29, contains information on contacting Patton technical support for assistance
- [Appendix A](#), starting on page 33, contains compliance and regulatory information for the FP1004E
- [Appendix B](#), starting on page 36, contains specifications for the FP1004E

For best results, read the contents of this guide *before* you install the FP1004E.

Precautions

Notes, cautions, and warnings, which have the following meanings, are used throughout this guide to help you become aware of potential extender problems. *Warnings* are intended to prevent safety hazards that could result in personal injury. *Cautions* refer to potential property damage or impaired functioning.

Note Calls attention to important information.



The shock hazard symbol and WARNING heading indicate a potential electric shock hazard. Strictly follow the warning instructions to avoid injury caused by electric shock.



The alert symbol and WARNING heading indicate a potential safety hazard. Strictly follow the warning instructions to avoid personal injury.



The shock hazard symbol and CAUTION heading indicate a potential electric shock hazard. Strictly follow the instructions to avoid property damage caused by electric shock.



The alert symbol and CAUTION heading indicate a potential hazard. Strictly follow the instructions to avoid property damage.



The alert symbol and IMPORTANT heading calls attention to important information.

For your protection



- Heed all warnings
- Follow all instructions
- Keep these instructions
- Clean the case with a soft slightly moist anti-static cloth
- Only use attachments/accessories specified by the manufacturer
- Refer all servicing to qualified service personnel. Servicing is required when the apparatus has been damaged in any way, such as power-supply cord or plug is damaged, liquid has been spilled or objects have fallen into the apparatus, the apparatus has been exposed to rain or moisture, does not operate normally, or has been dropped.

Safety when working with electricity



The FP1004E contains no user serviceable parts, and is not to be opened by the user. The equipment shall be returned to Patton Electronics for repairs or repaired by qualified service personnel.



Mains Voltage: Line voltages are present in the power supply when the power cord is connected. The mains outlet used to power the FP1004E shall be within 10 feet (3 meters) of the device, be easily accessible, and protected by a circuit breaker.



For units with an external power adapter, the adapter shall be a listed Limited Power Source. Protect the power cord from being walked on or pinched, particularly at plugs, convenience receptacles, and the point where they exit from the apparatus.



Hazardous network voltages are present in WAN ports regardless of whether power to the FP1004E is ON or OFF. To avoid electric shock, use caution when near WAN ports. When detaching the cables, detach the end away from the FP1004E first.



Do not work on the system or connect or disconnect cables during periods of lightning activity. Unplug this apparatus during lightning storms or when unused for long periods of time.



To reduce the risk of fire or electric shock, Protect the unit from moisture, vapors, and aggressive liquids. Do not expose this apparatus to rain or moisture. Do not use this apparatus near water. The apparatus shall not be exposed to dripping or splashing. No objects filled with liquids, such as vases, shall be placed on the apparatus.

General observations



Avoid exposing the unit to direct sunlight and other heat sources. Do not install near any heat sources such as radiators, heat registers, stoves, or other apparatus (including amplifiers) that produce heat.



Place the unit on a flat surface and ensure free air circulation. Do not stack multiple FP1004E devices directly on top of one another, and do not place items on top of the device. If you will be installing equipment above the FP1004E device, leave at least 2 inches (5 cm) of clearance between the devices.

Furthermore, leave at least 2 inches (5 cm) to the left, right, front, and rear of the FP1004E for proper ventilation.



In accordance with the requirements of council directive 2002/96/EC on Waste of Electrical and Electronic Equipment (WEEE), ensure that at end-of-life you separate this product from other waste and scrap and deliver to the WEEE collection system in your country for recycling.

Chapter 1 **General information**

Chapter contents

- FiberPlex 1004E Overview 13
- Features 14
- Standard Ordering Options..... 14
- Applications 14
 - Remote Network application 15
 - Distributed Wi-Fi application 15
 - Distributed IP video application 15
 - Secure Conference Room application 16
- FiberPlex 1004E Front 16
- FiberPlex 1004E Rear 18

FiberPlex 1004E Overview

Elegantly simple yet packed with an advanced feature set, the FiberPlex Technologies FP1004E is a powerful 6 Port 10/100/1000 Light Industrial Ethernet Switch (see [figure 1](#)). The unit interfaces UTP RJ-45 jacks (x4) to variously populated SFP positions.



Figure 1. FP1004E Front

The FP1004E is housed in commercial ‘throw down’ packaging. This version is a workhorse unit in various commercial and industrial environments. It is powered by a 9-VDC ‘wall wart’ style supply (included) or via bussed power supplied through an integrated three-pin Phoenix™ connector located on the FP1004E rear panel (see [figure 2](#)). Up to three FP1004E units can be installed in the optional 1U TDR-01 rack shelf (see [figure 3](#) on page 14). Both power options can be used simultaneously for a redundant power configuration.



Figure 2. FP1004E Rear



Figure 3. 1U TDR-01 rack shelf with FP1004E units installed

Features

The FiberPlex 1004E offers the following features:

- Supports optional light path failure monitoring function, report switch network management
- Supports hot swapping of SFP modules
- Supports IEEE802.1Q
- Supports Spanning Tree structure fault-tolerant network
- Automatic full-duplex and half-duplex conversion
- Active adopted four layers circuit structure, stable work, smooth data transmission, the anti-interference ability
- MTBF of more than 50,000 hours in accord with telecommunication standards

Standard Ordering Options

- **FP1004E/EUI**—Unit with no SFP modules included
- **FP1004E/L22/EUI**—Unit with (2) 1310 nm Multimode SFP modules (SFP-MC24XC-3131-2) included. Conforms to IEEE 1000BASE-LX standard.
- **FP1004E/L5B/EUI**—Unit with (2) 1310 nm Singlemode SFP Modules (SFP-SC24XC-3131-B) included. Conforms to IEEE 1000BASE-LX10 standard.

Applications

The flexible FP1004E is ideal for many applications including remote network, distributed Wi-Fi, distributed IP video, and secure conference room.

Remote Network application

- IP network
- VoIP
- SCADA sensors
- Networked audio
- IP video

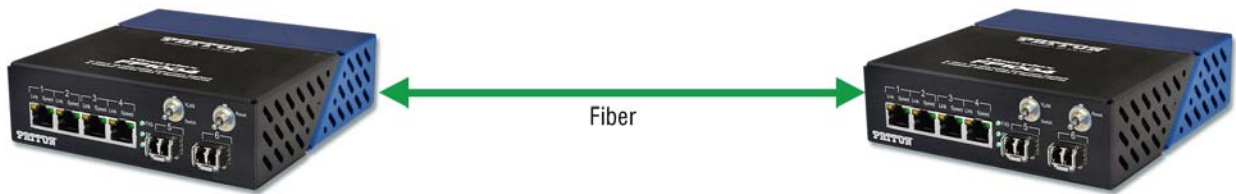

Figure 4. Remote Network application

Distributed Wi-Fi application

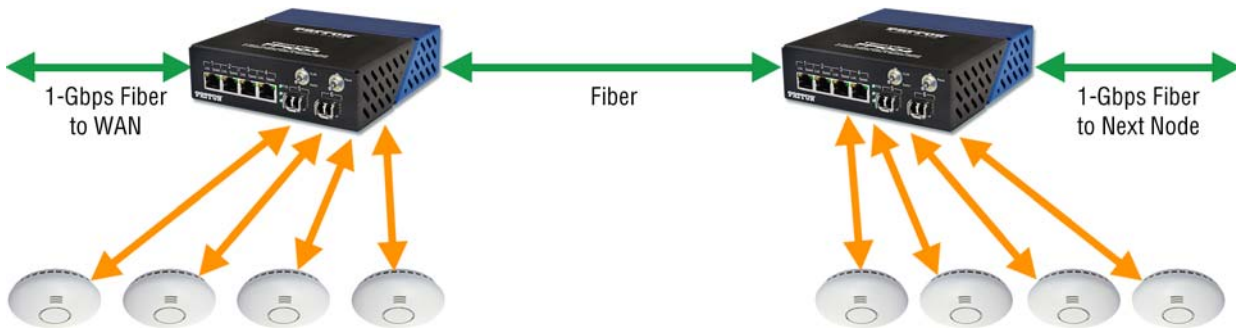

Figure 5. Distributed Wi-Fi application

Distributed IP video application

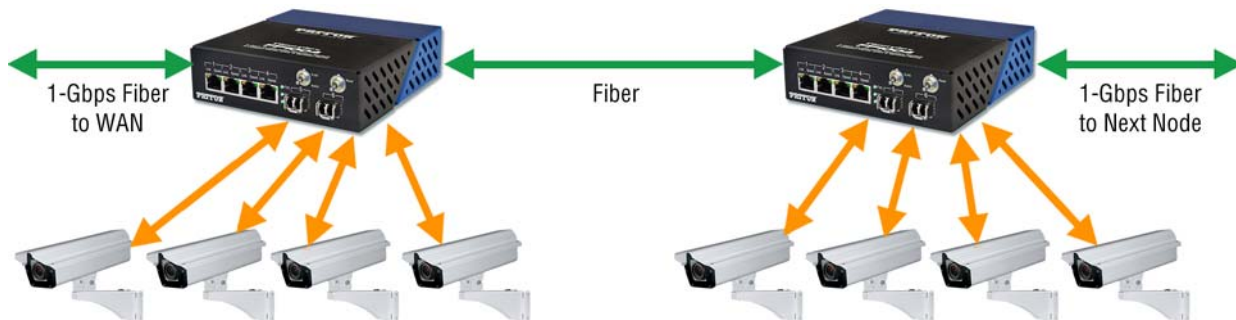

Figure 6. Distributed IP video application

Secure Conference Room application

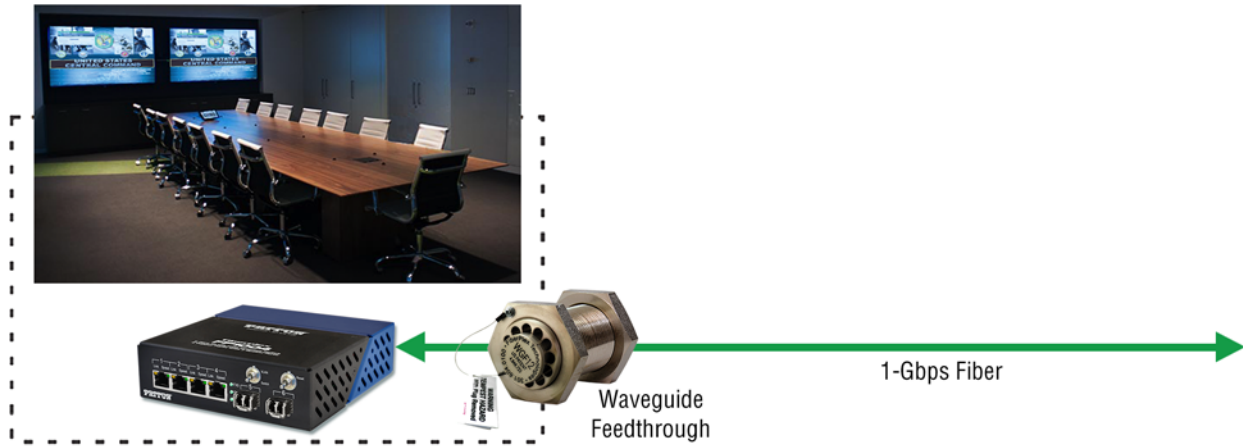

Figure 7. Secure Conference Room application

FiberPlex 1004E Front

FiberPlex 1004E front panel ports, LEDs, and switches (see figure 8) are described in table 1 on page 17.

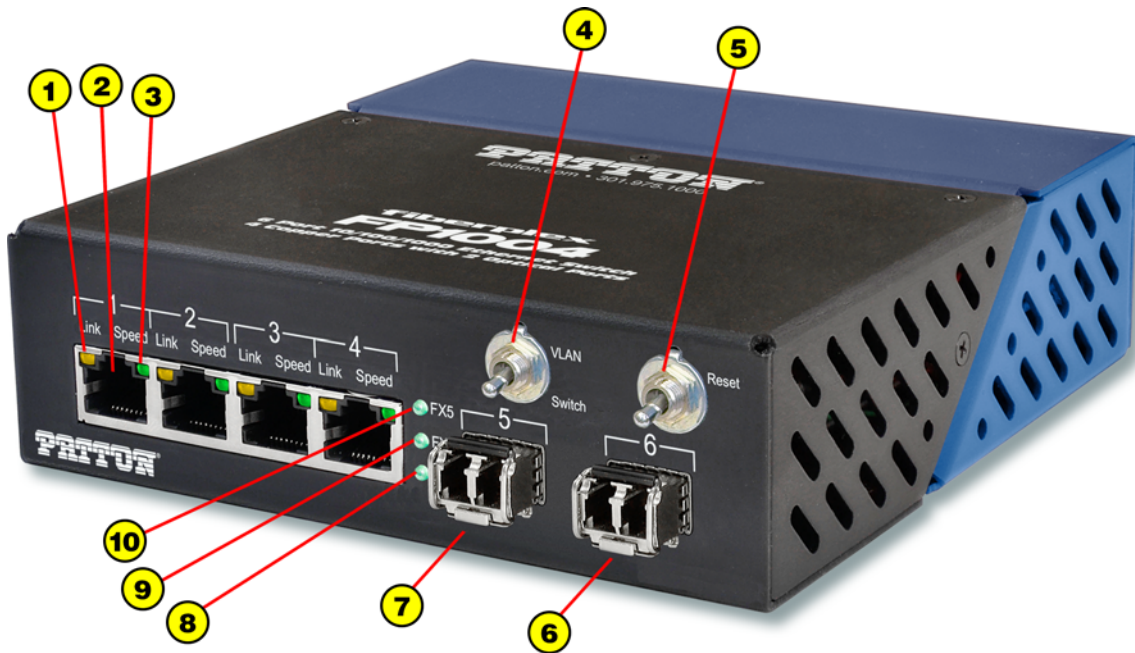

Figure 8. FP1004E front panel LEDs, ports, and switches

Table 1. Front panel ports, LEDs, and switches

#	Item	Description
1	Link LED (x4)	This LED, for each position, indicates port link status as follows: <ul style="list-style-type: none"> • On—Link is OK • Off—No link present • Blinking—Data is being received or transmitted
2	Ethernet Cable Port (x4)	These jacks are unshielded twisted pair (UTP) RJ-45 cable connection points for Cat 5 capability.
3	Speed LED (x4)	This LED, for each position, indicates port speed status as follows: <ul style="list-style-type: none"> • 3 Blinks Repeating—1000M speed • 2 Blinks Repeating—100M speed • 1 Blink Repeating—10M speed
4	VLAN/Switch switch	When the toggle is set up to <i>VLAN</i> , it puts the FP1004E in VLAN mode. Each port is set to 100Base-TX and isolated. This feature expects the FP1004E to be used in pairs. Ethernet port 1 on FP1004E will only connect to port 1 of another FP1004E. When the toggle is set down to <i>Switch</i> , it puts the FP1004E in standard switch mode..
5	Reset switch	The <i>Reset</i> switch toggle must be pressed upwards for one second after changing the <i>VLAN/Switch</i> switch setting from <i>VLAN</i> to <i>Switch</i> or <i>Switch</i> to <i>VLAN</i> .
6	SFP Slot 6	This is a standard MSA-compliant SFP module slot. (See section “ Inserting and Removing SFP Modules ” on page 24.) This port operates only at 1000Base-X rates. Do not connect ports 5 and 6 of one unit to SFP ports 5 and 6 of a second unit because this will cause a switching loop and the units will not operate properly.
7	SFP Slot 5	This is a standard MSA-compliant SFP module slot. (See section “ Inserting and Removing SFP Modules ” on page 24.) This port operates only at 1000Base-X rates. Do not connect ports 5 and 6 of one unit to SFP ports 5 and 6 of a second unit because this will cause a switching loop and the units will not operate properly.
8	PWR (power) LED	When lit, indicates that the FP1004E is powered on.
9	FX6 LED	This LED indicates status of SFP slot 6 as follows: <ul style="list-style-type: none"> • ON—Fiber link is OK • OFF—Fiber link has failed • Blinking—Activity
10	FX5 LED	This LED indicates status of SFP slot 5 as follows: <ul style="list-style-type: none"> • ON—Fiber link is OK • OFF—Fiber link has failed • Blinking—Activity

FiberPlex 1004E Rear

FiberPlex 1004E rear panel ports (see [figure 9](#)) are described in [table 2](#).



Figure 9. FP1004E rear panel ports

Table 2. Rear panel ports

#	Item	Description
1	Circular DC Power Connection	DC power entry for the unit. This is a standard DC connection for use with the included DC wall power supply.
2	Phoenix™ Power Connection	Secondary power option for the FP1004E. This is wired in direct parallel with the circular connector and has the addition of a positive earth chassis ground connection. This can be used to power the unit on a client-supplied power buss.

Chapter 2 Installation

Chapter contents

- Introduction20
- Initial Inspection20
- Unpacking.....20
 - Disposal of Packing Materials20
- Choosing the Installation Site.....20
 - Ambient Temperature20
 - Grounding and Power Supply21
- Power Requirements and Mounting.....21
 - Redundant Power21
 - Standalone21
 - Surface Mount21
 - DIN Rail22
 - Tray Mounting23
- Inserting and Removing SFP Modules.....24
 - Identifying the Latch Type of the SFP Module25
 - Inserting a Module25
 - Removing a Module26
- Additional Information27
 - Bonding Units27
 - SFP MSA Compliance27

Introduction

This chapter describes installing the following FP1004E. Installation consists of the following:

- Inspecting the FP1004E shipping container (see section “[Initial Inspection](#)”)
- Unpacking the FP1004E (see section “[Initial Inspection](#)”)
- Selecting an appropriate installation site (see section “[Choosing the Installation Site](#)”)
- Determine the type of power required for the installation mount (see section “[Power Requirements and Mounting](#)” on page 21)
- Insert or remove SFP modules (see section “[Inserting and Removing SFP Modules](#)” on page 24)

Initial Inspection

Immediately upon receipt, inspect the shipping container for damage. The container should be retained until the shipment has been checked for completeness and the equipment has been checked mechanically and electrically. If the shipment is incomplete, if there is mechanical damage, or if the unit fails to operate notify FiberPlex and make the shipping materials available for the carrier's inspection.?

Unpacking

Check the equipment for any transport damage. If the unit is mechanically damaged, if liquids have been spilled or if objects have fallen into the unit, it must not be connected to the AC power outlet, or it must be immediately disconnected by unplugging the power cable. Repair must only be performed by trained personnel in accordance with the applicable regulations.

Disposal of Packing Materials

The packing materials have been selected with environmental and disposal issues in mind. All packing material can be recycled. Recycling packing saves raw materials and reduces the volume of waste. If you need to dispose of the transport packing materials, recycling is encouraged.

Choosing the Installation Site

Install the unit where the following conditions are met:

- The temperature and the relative humidity of the operating environment must be within the specified limits during operation of the unit. Values specified are applicable to the air inlets of the unit.
- Condensation may not be present during operation. If the unit is installed in a location subject to large variations of ambient temperature (e.g. in an OB-van), appropriate precautions must be taken.
- Unobstructed air flow is essential for proper operation. Ventilation openings of the unit are a functional part of the design and must not be obstructed in any way during operation (e.g. - by objects placed upon them, placement of the unit on a soft surface, or improper installation of the unit within a rack or piece of furniture).
- The unit must not be unduly exposed to external heat sources (direct sunlight, spot lights).

Ambient Temperature

Units and systems by FiberPlex are generally designed for an ambient temperature range (i.e. temperature of the incoming air) of +5 to +40 °C. When rack mounting the units, the following facts must be considered:

- The permissible ambient temperature range for operation of the semiconductor components is 13 to 158°F (-10 to 40°C) (commercial temperature range for operation).
- The air flow through the installation must allow exhaust air to remain cooler than 70 °C at all times.
- Average temperature increase of the cooling air shall be about 20 °C, allowing for an additional maximum 10 °C increase at the hottest components.

If the cooling function of the installation must be monitored (e.g. for illumination with spot lamps), the exhaust air temperature must be measured directly above the modules at several places within the enclosure.

Grounding and Power Supply

Grounding of units with mains supply (class I equipment) is performed via the protective earth (PE) conductor integrated in three pin Phoenix connector. Units with battery operation (< 60 V, class III equipment) must be earthed separately. Grounding the unit is one of the measures for protection against electrical shock hazard (dangerous body currents). Hazardous voltage may not only be caused by defective power supply insulation, but may also be introduced by the connected audio or control cables.

This equipment may require the use of a different line cord, attachment plug, or both, depending on the available power source at installation. If the attachment plug needs to be changed, refer servicing to qualified personnel.

Power Requirements and Mounting

Flexible mounting allows the FP1004E to be rack shelf mounted or used in a standalone configuration. Up to 3 FP1004E units can be mounted on a TDR-01 shelf and powered by a single, integral cable. Alternately, the FP1004E can be used in a standalone application when paired with the included DC wall adapter.

Redundant Power

Both the wall adapter and Phoenix connector can be connected simultaneously. The two power inputs are diode combined for load balancing. Hitless redundant powering is achieved when both power connections are utilized.

Standalone

For standalone applications, the FP1004E comes with 4 peel-and-stick rubber feet. Simply peel the paper backing from the rubber foot and affix to four corners of the FP1004E.

Surface Mount

Surface mounting on a wall, desk, or other vertical surface can be accomplished by using either the supplied peel-and-stick Velcro pads, or by using the integrated keyhole mounts with the supplied wood screws (see [figure 10](#) on page 22).

To use the wood screws:

1. Mark the surface using the supplied template
2. Screw the #2 ½-inch wood screws into the surface at each mark
3. Leave a small amount of thread to accommodate the thickness of the FP1004E case
4. Put the large part of the keyhole over the screw head and pull to engage

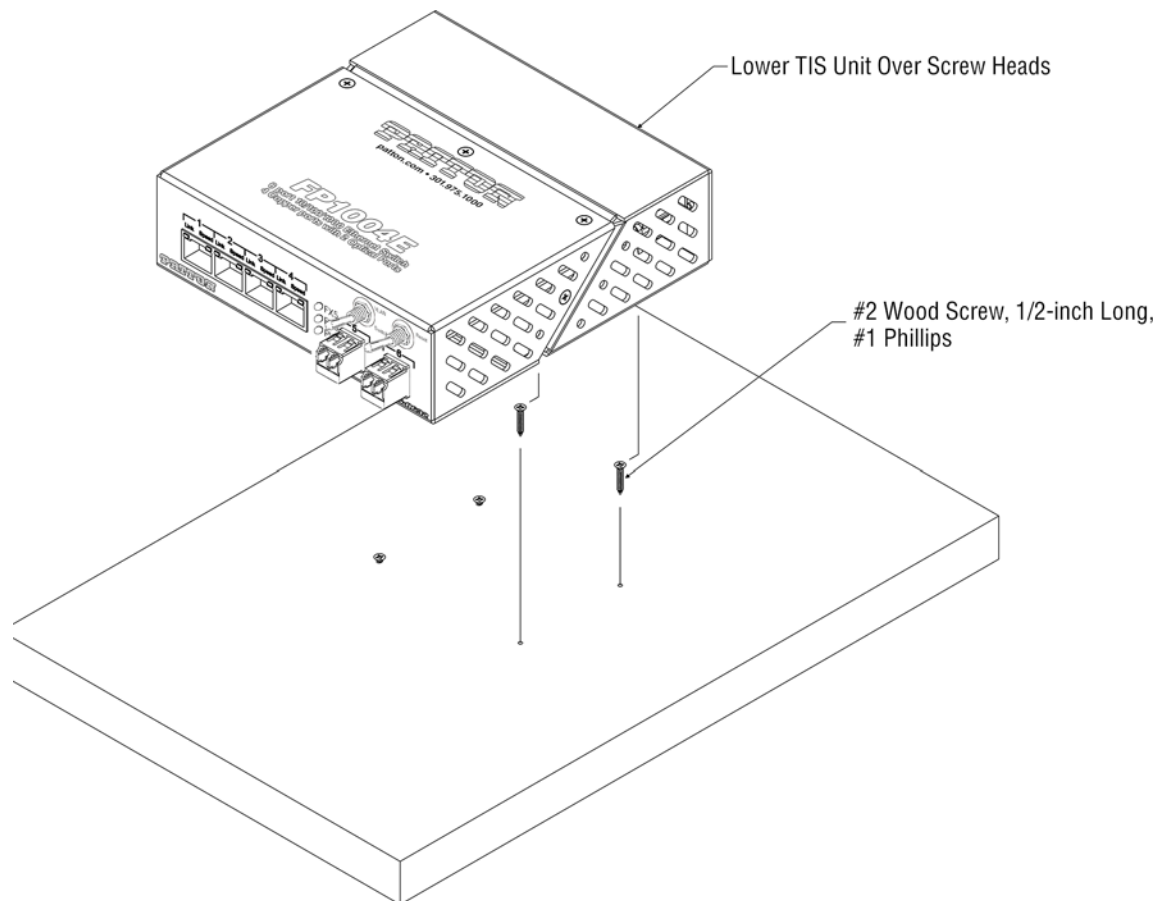

Figure 10. FP1004E Surface Mount

DIN Rail

Using the TD-DINR, the FP1004E can be mounted to a DIN rail. See the TD-DINR user manual for more details on configuration options. Mount the FP1004E the TD-DINR in the same manner regardless of the initial configuration of the mount itself or the height of top hat DIN rail utilized (35 x 7.5 or 35 x 15mm). The edge mounting solution happens to be shown in [figure 11](#) on page 23. All fasteners necessary for configuration and mounting are included with the TD-DINR.

1. Line up key hole on the bottom of the FP1004E with the studs on the mounting bracket and push flat against the plate.
2. Slide the FP1004E forward until it stops.
3. Tighten the retaining screw until snug.
4. Snap the rail clips on to the DIN Rail.

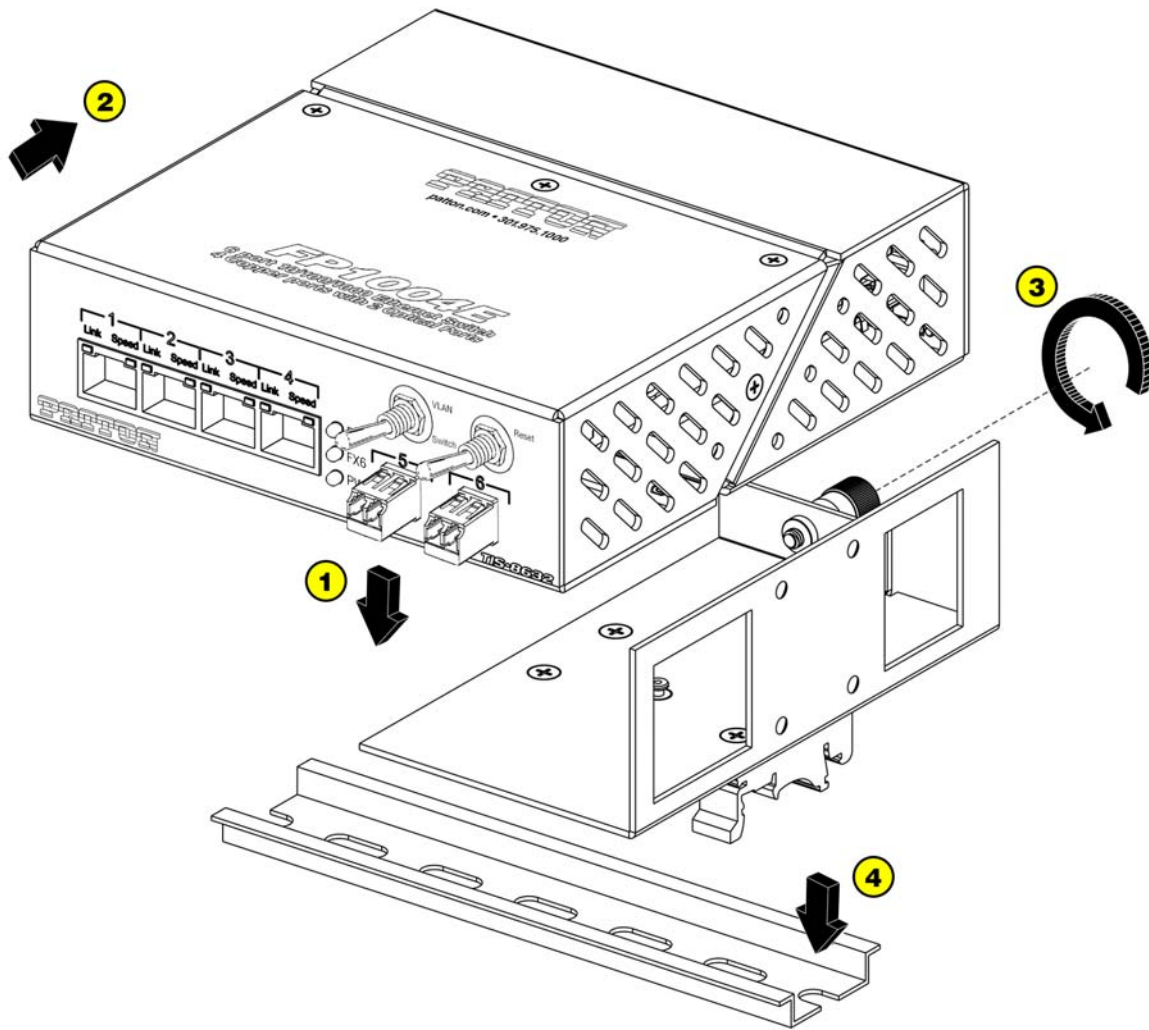

Figure 11. FP1004E installation on a TD-DINR

Tray Mounting

Complementing the flexibility of the FiberPlex TD Series of fiber optic modules, the TDR-01-AC provides mounting, power and cable management for up to 3 FP1004E modules in a compact and rugged aluminum 1U rack (see [figure 12](#) on page 24). The integrated key-hole mounting holes on the bottom the TD units lock securely on mating studs while a rear retention bar holds them securely in place. A 6 position wiring harness and included power adapter provide, not just 9 VDC power, but a positive earth ground to the modules via 3 position Phoenix™ locking power connectors. Managing all that cabling and fiber can sometimes be quite a chore so an extended cabling tray with integrated tie down points are provided to help make your installation clean.

Note The TDR and TDP trays use a 9 VDC 30W (3.5A) power adapter. When 3 FP1004E are used in the same rack, certain SFP populations could exceed 30W. Please carefully check your configuration against the specification table to verify your power consumption.

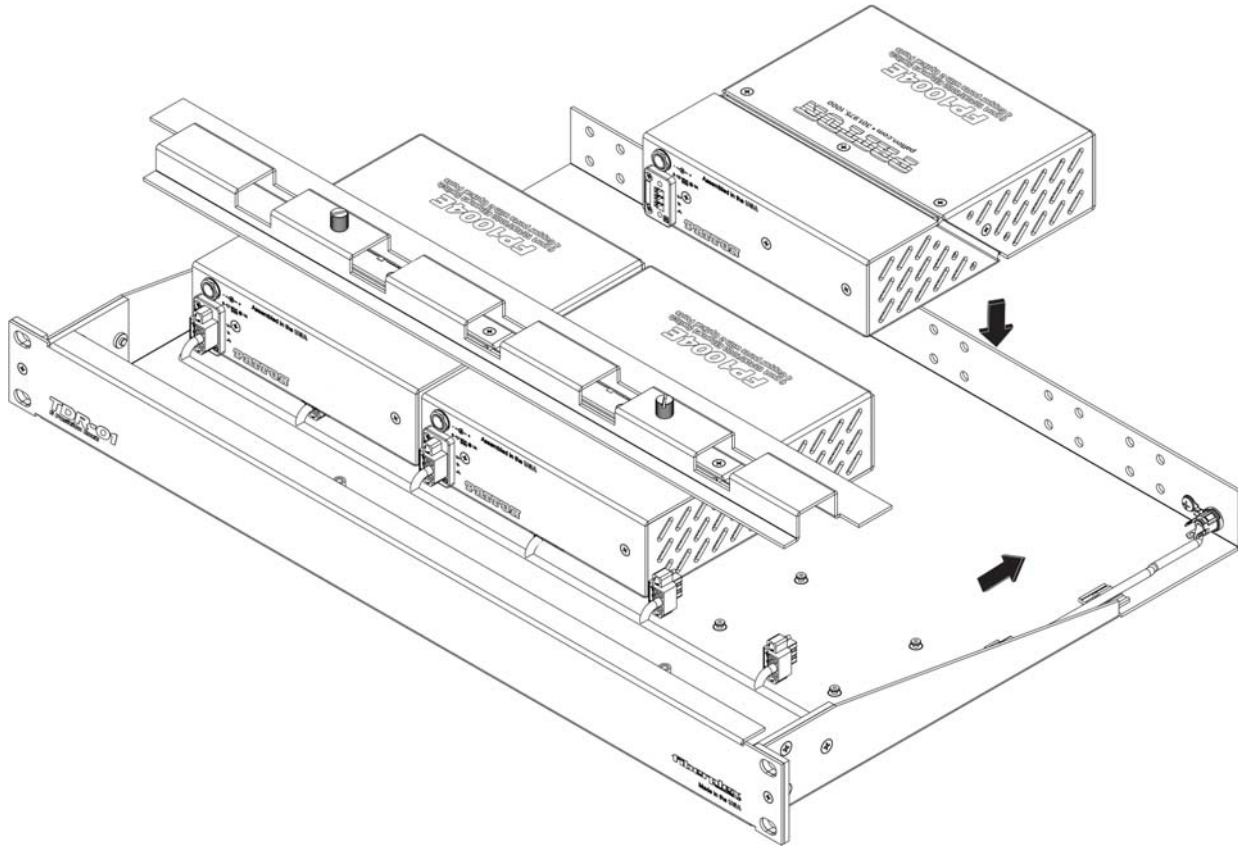

Figure 12. FP1004E installation on a TDR-01-AC tray

Inserting and Removing SFP Modules



CAUTION

SFP Modules are static sensitive. To prevent damage from electrostatic discharge (ESD), it is recommended to attach an ESD preventative wrist strap to your wrist and to a bare metal surface when you install or remove an SFP Module.

Disconnect all optical or copper cables from SFP Modules prior to installing or removing the SFP Module. Failure to do so could result in damage to the cable, cable connector or the SFP Module itself. Removing and inserting an SFP Module can shorten its useful life, so you should not remove and insert SFP Modules any more often than is absolutely necessary.

Protect optical SFP modules by inserting clean dust covers into them after the cables are removed. Be sure to clean the optic surfaces of the fiber cables before you plug them back into the optical ports of another SFP module. Avoid getting dust and other contaminants into the optical ports of your SFP modules, because the optics will not work correctly when obstructed with dust.

Identifying the Latch Type of the SFP Module

SFP modules have various latching mechanisms to secure them into the SFP Cage of a device. FiberPlex Modules can support a host of manufacturers and brands of SFP Modules so the user may encounter any number of different latches. Some of these are described below:

Bail Clasp

The bail clasp SFP module has a clasp that you use to remove or install the SFP module.

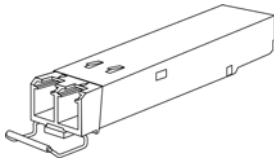

Actuator Button

The actuator button SFP module includes a button that you push in order to remove the SFP module from a port. This button can either lift 'Up' or press 'In' to release the SFP module depending on the manufacturer.

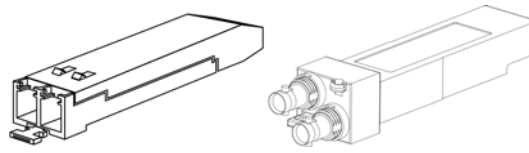

Mylar Tab

The Mylar tab SFP module has a tab that you pull to remove the module from a port.

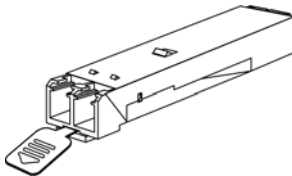

Slide Tab

The slide tab SFP module has a tab underneath the front of the SFP module that you use to disengage the module from a port.

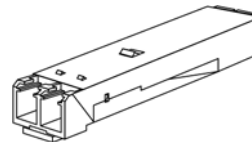

Inserting a Module

1. Attach an anti-static wrist or ankle strap, following its instructions for use.
2. Disconnect and remove all interface cables from SFP module.
3. If the SFP module has a Bail Clasp, close the Bail Clasp before inserting the SFP module.
4. With the gold finger connector on the bottom and the label on the top, line up the SFP module with the empty cage and slide it in making sure that it is completely inserted and seated in the cage (see [figure 13](#)).

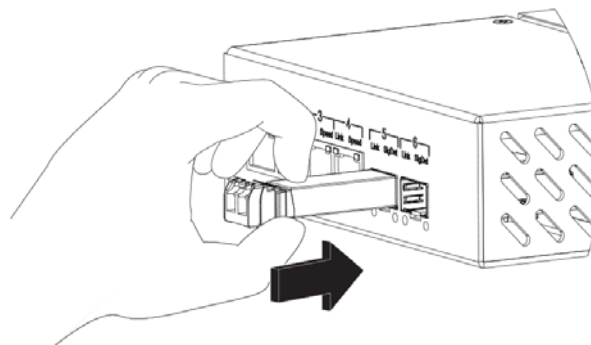

Figure 13. Inserting a Module

Removing a Module

1. Attach an anti-static wrist or ankle strap, following its instructions for use.
2. Disconnect and remove all interface cables from SFP module.
3. Release the latching mechanism (see [figure 14](#)).
 - Bail Clasp—Open the bail clasp on the SFP module with your finger in a downward direction.
 - Actuator Button—Gently press the actuator up (or in) while pulling the body of the SFP module to release the SFP module from the cage.
 - Mylar Tab—Pull the tab gently in a straight outward motion until it disengages from the port. Make sure the tab is not twisted when pulling as it may become disconnected from the SFP module.

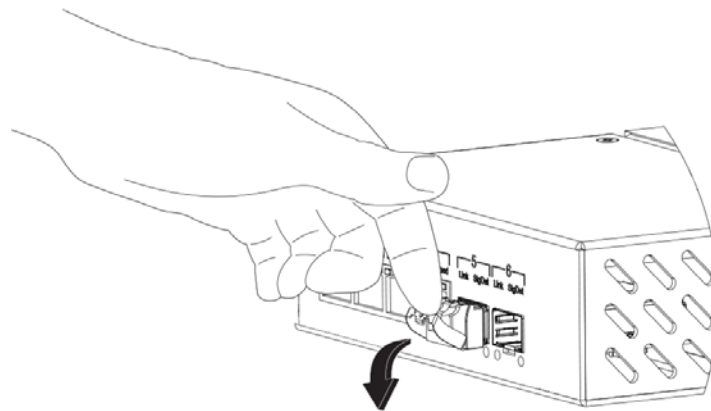

Figure 14. Releasing the latching mechanism

- Slide Tab—With your thumb, push the slide tab on the bottom front of the SFP module in the direction of the equipment to disengage the module from the line card port (see [figure 15](#)). If you pull on the SFP module without disengaging the tab, you can damage the SFP module.

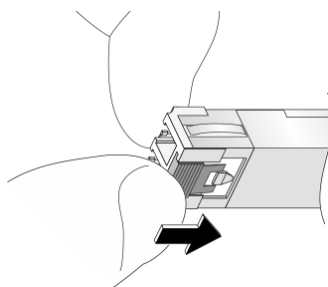

Figure 15. Releasing the slide tab

4. Grasp the SFP module between your thumb and index finger and carefully remove it from the port (see [figure 16](#) on page 27)
5. Place the SFP module on an anti-static mat, or immediately place it in a static shielding bag or container

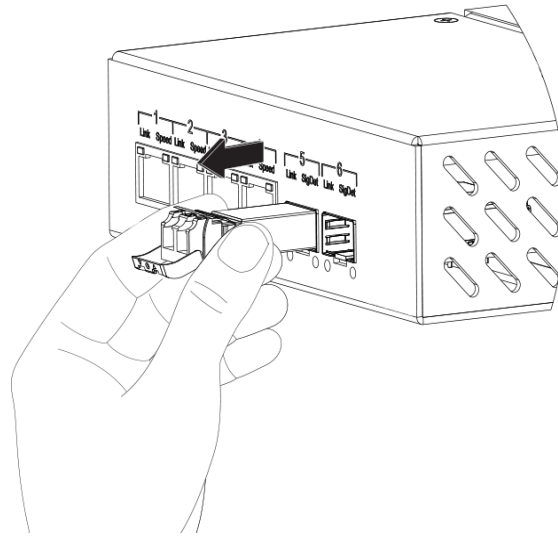

Figure 16. Removing a module

Congratulations! You have installed the FP1004E. Refer to section “[Additional Information](#)” if you want to bond the FP1004E to another FP1004E, or for information regarding SFP MSA compliance.

Additional Information

Bonding Units

Two FP1004E can be bonded together locally to make the equivalent of an 8 Copper x 2 fiber switch by using an SFP Passive Cable Assembly like the FiberPlex FC-QDAXX1-0-0.5M (see [figure 17](#)). These passive cables are terminated with SFP compatible connectors and are considerably cheaper than using a pair of optical modules with a fiber jumper. The cables are only useful for short connections.

In this configuration, one SFP port on each FP1004E is occupied by the Passive Cable Assembly leaving one SFP port on each FP1004E that can still be utilized for optical modules. This also results in 8 local 10/100/1000 copper ports.

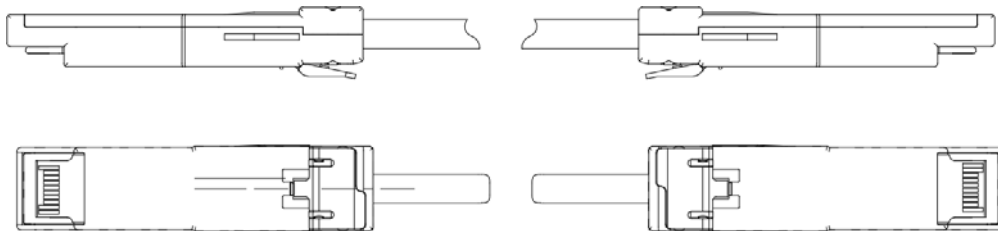

Figure 17. Representative Drawing of an SFP Passive Cable Assembly

SFP MSA Compliance

The SFP Multisource Agreement (MSA) is an agreement that was drafted among competing manufacturers of SFP optical modules. The SFF Committee was formed to oversee the creation and maintenance of these agreements including the SFP MSA designated as INF-8074i. This agreement describes a mutually agreed upon

standard for the form and function of SFP modules. However, not all SFPs produced are MSA compliant. The MSA provides for a transceiver (TX/RX) pinout. Other industries such as broadcast had the need for dual TX and dual RX SFP for uni-directional applications such as video. Naturally, a non-MSA standard was introduced allocating pinout assignments for dual output and dual input I/O configurations. In addition, some of the internal serial communication pins were reassigned.

Note The FP1004E will only accept MSA compliant SFP modules that support a 1.25 Gbps data rate.

Table 3. Pinout Comparison Chart

Pin	Transceiver (MSA)	Transceiver (Non-MSA)	Dual TX (Non-MSA)	Dual RX (Non-MSA)
1	VEE	VEE	VEE	VEE
2	TX_FAULT [VEE]	VEE	NC	Rx2-
3	TX_DIS	NC	NC	Rx2+
4	MOD_DEF(2) - SDA	VEE	VEE	VEE
5	MOD_DEF(1) - SCL	SCL	SCL	SCL
6	MOD_DEF(0) - PRESENCE [VEE]	SDA	SDA	SDA
7	Rate [NC]	VEE	VEE	VEE
8	LOS	RX1_LOS	Tx2+	NC
9	VEE	NC	Tx2-	NC
10	VEE	NC	Tx2_DIS	NC
11	VEE	VEE	VEE	VEE
12	RD-	Rx1-	NC	Rx1-
13	RD+	Rx1+	NC	Rx1+
14	VEE	VEE	VEE	VEE
15	VCC	VCC	VCC	VCC
16	VCC	VCC	VCC	VCC
17	VEE	VEE	VEE	VEE
18	TD+	Tx1+	Tx1+	NC
19	TD-	Tx1-	Tx1-	NC
20	VEE	Tx1_DIS	Tx1_DIS	NC

Chapter 3 **Contacting Patton for Assistance**

Chapter contents

- Introduction30
- Contact information30
 - Online Support30
 - Contacting Patton Technical Services for Free Support30
- Warranty Service and Returned Merchandise Authorizations (RMAs)30
 - Warranty coverage31
 - Out-of-warranty service31
 - Returns for credit31
 - Return for credit policy31
 - RMA numbers31
 - Shipping instructions31
- Disposal of Used Equipment32

Introduction

This chapter contains the following information:

- “Contact information”—describes how to contact Patton technical support for assistance.
- “Warranty Service and Returned Merchandise Authorizations (RMAs)” —contains information about obtaining a return merchandise authorization (RMA).
- “Disposal of Used Equipment” on page 32—describes how to properly dispose of the used, out-of-warranty device

Contact information

Patton Electronics offers a wide array of free technical services. If you have questions about any of our other products we recommend you begin your search for answers by using our technical knowledge base. Here, we have gathered together many of the more commonly asked questions and compiled them into a searchable database to help you quickly solve your problems:

Online Support

Available at <http://www.patton.com/support/kb.asp>

Contacting Patton Technical Services for Free Support

REGION	North America	Western Europe	Central & Eastern Europe	Middle East North Africa
Location	Maryland, USA	Bern, Switzerland	Budapest, Hungary	Beirut, Lebanon
Time Zone	EST/EDT UTC/GMT - 4/5 hours	CET/CEDT UTC/GMT + 1/2 hours	CET/CEDT UTC/GMT + 1/2 hours	EET/EEDT UTC/GMT + 2/3 hours
Business Hours	Monday-Friday 8:00am to 5:00pm	Monday-Friday 09:00 to 12:00 13:30 to 17:30	Monday-Friday 8:30 to 17:00	Monday-Friday 8:00am to 5pm
Email	support@patton.com	support@patton.com	support@patton.com	support@patton.com
Phone	+ 1 301 975 1007	+41 31 985 25 55	+36 439 3835	+96 1 359 1277
Fax	+1 301 869 9293	+41 31 985 2526		

Warranty Service and Returned Merchandise Authorizations (RMAs)

Patton Electronics is an ISO-9001 certified manufacturer and our products are carefully tested before shipment. All of our products are backed by a comprehensive warranty program.

- Note** If you purchased your equipment from a Patton Electronics reseller, ask your reseller how you should proceed with warranty service. It is often more convenient for you to work with your local reseller to obtain a replacement. Patton services our products no matter how you acquired them.

Warranty coverage

Our products are under warranty to be free from defects, and we will, at our option, repair or replace the product should it fail within one year from the first date of shipment. Our warranty is limited to defects in workmanship or materials, and does not cover customer damage, lightning or power surge damage, abuse, or unauthorized modification.

Out-of-warranty service

Patton services what we sell, no matter how you acquired it, including malfunctioning products that are no longer under warranty. Our products have a flat fee for repairs. Units damaged by lightning or other catastrophes may require replacement.

Returns for credit

Customer satisfaction is important to us, therefore any product may be returned with authorization within 30 days from the shipment date for a full credit of the purchase price. If you have ordered the wrong equipment or you are dissatisfied in any way, please contact us to request an RMA number to accept your return. Patton is not responsible for equipment returned without a Return Authorization.

Return for credit policy

- Less than 30 days: No Charge. Your credit will be issued upon receipt and inspection of the equipment.
- 30 to 60 days: We will add a 20% restocking charge (crediting your account with 80% of the purchase price).
- Over 60 days: Products will be accepted for repairs only.

RMA numbers

RMA numbers are required for all product returns. You can obtain an RMA by doing one of the following:

- Completing a request on the RMA Request page in the *Support* section at **www.patton.com**
- By calling **+1 (301) 975-1007** and speaking to a Technical Support Engineer
- By sending an e-mail to **returns@patton.com**

All returned units must have the RMA number clearly visible on the outside of the shipping container. Please use the original packing material that the device came in or pack the unit securely to avoid damage during shipping.

Shipping instructions

The RMA number should be clearly visible on the address label. Our shipping address is as follows:

Patton Electronics Company

RMA#: xxxx

7622 Rickenbacker Dr.

Gaithersburg, MD 20879-4773 USA

Patton will ship the equipment back to you in the same manner you ship it to us. Patton will pay the return shipping costs.

Disposal of Used Equipment

Used equipment contains valuable raw materials as well as substances that must be disposed of professionally. Please dispose of used equipment via an authorized specialist dealer or via the public waste disposal system, ensuring any material that can be recycled has been. Please take care that your used equipment cannot be abused. After having disconnected your used equipment from the mains supply, make sure that the mains connector and the mains cable are made useless.

Appendix A **Compliance Information**

Chapter contents

- Regulatory Information34
 - EMC Directive:34
 - Low-Voltage Directive (Safety):34
 - PSTN:34
- Radio and TV Interference (FCC Part 15)34
- CE Declaration of Conformity34
- Authorized European Representative35
- Service35

Regulatory Information

EMC Directive:

- FCC Part 15, Class B
- EN55022, Class B
- EN55024
- EN50581
- EN50564:2011

Low-Voltage Directive (Safety):

- IEC/EN60950-1, 2nd Edition
- UL60950-1/CSA C22.2 No. 60950-1

PSTN:

- This device is not intended nor approved for connection to the PSTN

Radio and TV Interference (FCC Part 15)

This device generates and uses radio frequency energy, and if not installed and used properly—that is, in strict accordance with the manufacturer’s instructions—may cause interference to radio and television reception. The device has been tested and found to comply with the limits for a Class B computing device in accordance with specifications in Subpart B of Part 15 of FCC rules, which are designed to provide reasonable protection from such interference in a commercial installation. However, there is no guarantee that interference will not occur in a particular installation. If the device does cause interference to radio or television reception, which can be determined by disconnecting the unit, the user is encouraged to try to correct the interference by one or more of the following measures: moving the computing equipment away from the receiver, re-orienting the receiving antenna and/or plugging the receiving equipment into a different AC outlet (such that the computing equipment and receiver are on different branches).

CE Declaration of Conformity

This device is in compliance with the essential requirements and other relevant provisions of Directive 2004/30/EC relating to electromagnetic compatibility and Directive 2014/35/EC relating to electrical equipment designed for use within certain voltage limits. Council Directive 2011/65/EU on the approximation of the laws of the member states relating to RoHS compliance and Council Directive 2009/125/EC establishing a framework for the setting of ecodesign requirements for energy-related products. The Declaration of Conformity may be obtained from Patton Electronics, Inc at www.patton.com/certifications.

The safety advice in the documentation accompanying this device shall be obeyed. The conformity to the above directive is indicated by CE mark on the device.

Authorized European Representative

D R M Green

European Compliance Services Ltd
Greyfriars Court
Paradise Square
Oxford, OX1 1BE, UK

Service

All warranty and non-warranty repairs must be returned freight prepaid and insured to Patton Electronics. All returns must have a Return Materials Authorization number on the outside of the shipping container. This number may be obtained from Patton Electronics Technical Services at:

- Tel: +1 (301) 975-1007
- Email: support@patton.com
- URL: <http://www.patton.com>

Packages received without an RMA number will not be accepted.

Appendix B Specifications

Chapter contents

Supported Standards	37
Electrical Specifications	37
Optical Specifications	38
Physical Specifications	38

Supported Standards

Table 4. Copper UTP RJ-45 Interface

IEEE Standard	Cable	Data Rate	IEEE Max Distance
10BASE-T	CAT-3 or better	10 Mbps	100 m
100BASE-T	CAT-5 or better	100 Mbps	100 m
1000BASE-T	CAT-5e or better	1000 Mbps	100 m

Table 5. Optical SFP Interface

IEEE Standard	FiberPlex SFP	Fiber Type	λ (nm)	Avg Transmitter Power (dBm)	Receiver Sensitivity (dBm)	IEEE Max Distance
1000BASE-CX	FC-QDAXX1-0-1M	Copper	n/a	n/a	n/a	25 m
1000BASE-SX	SFP-MC24XC-8585-0	Multimode	850	-6	-18	500 m
1000BASE-LX	SFP-MC24XC-3131-2	Multimode	1310	-11	-24	500 m
1000BASE-LX	SFP-MC24XC-3131-2	Singlemode	1310	-11	-24	2 km
1000BASE-LX10	SFP-SC24XC-3131-B	Singlemode	1310	-6	-25	20 km
1000BASE-EX	SFP-SC24XC-3131-C	Singlemode	1310	-2.5	-25	40 km
1000BASE-ZX	SFP-SC24XC-5555-F	Singlemode	1550	+2.5	-25	70 km
1000BASE-BX10	SFP-SC24BD-4931-B	Singlemode	1490/1310	-6	-25	20 Km
1000BASE-T	SFP-RTGTXC-0000-0	Copper	n/a	n/a	n/a	100 m

Electrical Specifications

		Min	Typ	Max	Unit
Environmental	Storage Temperature (°C)	-40	-	85	°C
	Operating Temperature (°C)	0	-	50	°C
Power Requirement	<i>Voltage Range</i>	-	9	-	VDC
	Supply Current with SFP ports empty	100	-	525	mA
	Supply Current with 2 optical SFPs	475	-	900	mA
	Supply Current with 1 optical and 1 RJ45 SFP	385	-	1150	mA
	Supply Current with 2 RJ45 SFP	240	-	1340	mA
Phoenix™ Mating Plug 3 Position Power (P/N 1827716)	Wire Accepted	14	-	28	AWG
	Nominal Voltage	-	-	300	V
	Nominal Current	-	-	8	A
Power Adapter Connection	Standard 5.5 x 2.1 mm DC barrel, center positive				

Optical Specifications

External SFP Interface		Min	Typ	Max	Unit
Data Rate	Storage Temperature (°C)	-	1.25	-	Gbps
Recommended Jitter	Operating Temperature (°C)	-	40	-	Psec
Operating Voltage	<i>Voltage Range</i>	-	3.3	-	VDC
Maximum Current	Supply Current with SFP ports empty	-	-	500	mA
Optical Modules	SFP MSA (SFF-8431, SFF-8432, SFF-8433) compliant slot, data rate 1.25 Gbps OC24				

Physical Specifications

Dimensions: 5.63W x 1.66H x 5.50D inch (143W X 42H x 140D mm) (see figure 18).

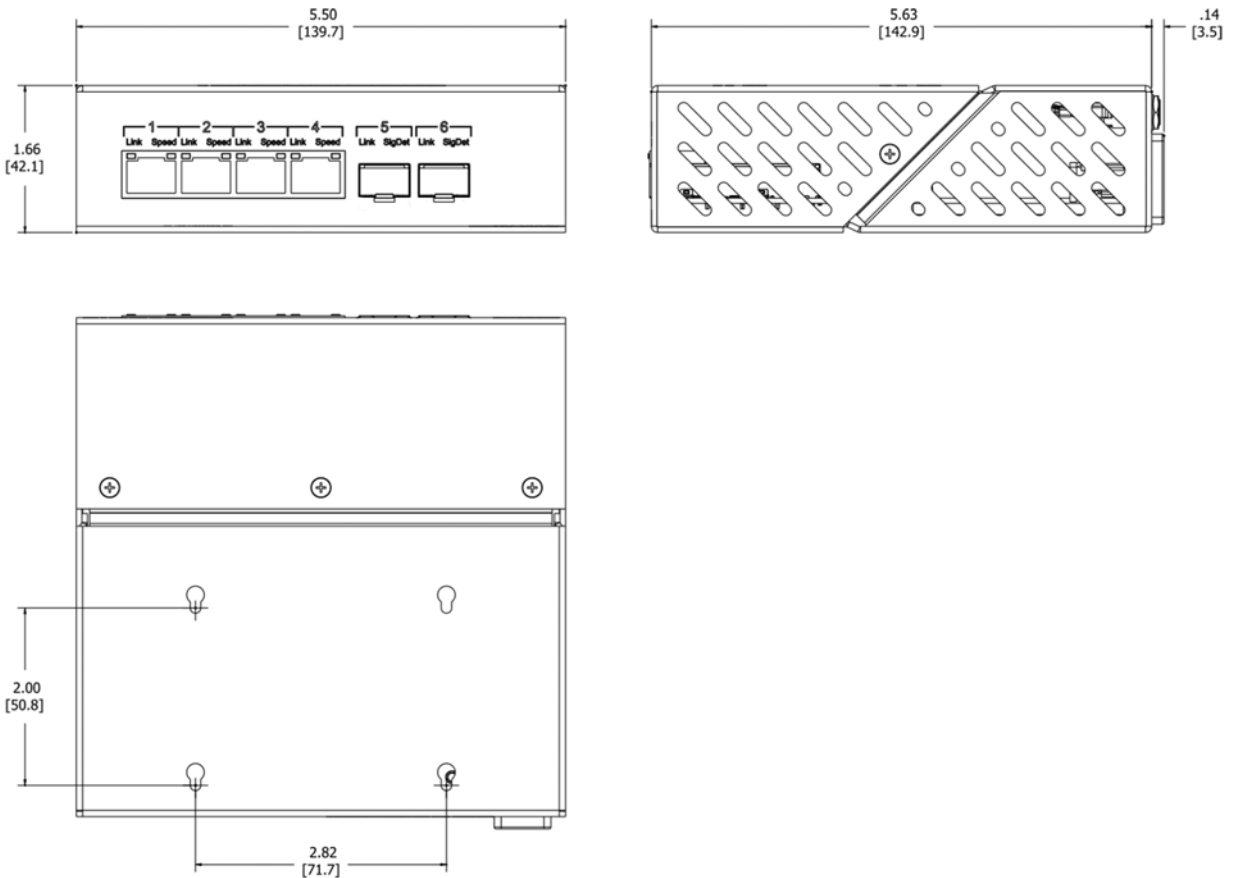

Figure 18. FP1004E Dimensions

Power Consumption: <10W

Operating Temperature: 13 to 158°F (-10 to 40°C)

Operating humidity: up to 90%, non condensing

Industrial Communication Products Ltd
Tel: +44 (0) 203 086 9569

Web: www.industrialcomms.co.uk
E-mail: sales@industrialcomms.com