

USER MANUAL

MODEL 222N9 Ultra-miniature RS-232 (EIA-574) to RS-422 Interface Converter



PATTON
Electronics Co.



An ISO-9001
Certified Company

Part #07M222N9-B
Doc. #030013U,
Rev. C
Revised 1/21/08

SALES OFFICE
(301) 975-1000
TECHNICAL SUPPORT
(301) 975-1007
<http://www.patton.com>

1.0 WARRANTY INFORMATION

Patton Electronics warrants all Model 222N9 components to be free from defects, and will—at our option—repair or replace the product should it fail within one year from the first date of shipment.

This warranty is limited to defects in workmanship or materials, and does not cover customer damage, abuse, or unauthorized modification. If this product fails or does not perform as warranted, your sole recourse shall be repair or replacement as described above. Under no condition shall **Patton Electronics** be liable for any damages incurred by the use of this product. These damages include, but are not limited to, the following: lost profits, lost savings, and incidental or consequential damages arising from the use of or inability to use this product. **Patton Electronics** specifically disclaims all other warranties, expressed or implied, and the installation or use of this product shall be deemed an acceptance of these terms by the user.

1.1 RADIO AND TV INTERFERENCE

The Model 222N9 generates and uses radio frequency energy, and if not installed and used properly—that is, in strict accordance with the manufacturer's instructions—may cause interference to radio and television reception. The Model 222N9 has been tested and found to comply with the limits for a Class A computing device in accordance with the specifications in Subpart J of Part 15 of FCC rules, which are designed to provide reasonable protection from such interference in a commercial installation. However, there is no guarantee that interference will not occur in a particular installation. If the Model 222N9 does cause interference to radio or television reception, which can be determined by disconnecting the RS-232 interface, the user is encouraged to try to correct the interference by one or more of the following measures: moving the computing equipment away from the receiver, re-orienting the receiving antenna, and/or plugging the receiving equipment into a different AC outlet (such that the computing equipment and receiver are on different branches).

1.2 CE NOTICE

The CE symbol on your Patton Electronics equipment indicates that it is in compliance with the Electromagnetic Compatibility (EMC) directive and the Low Voltage Directive (LVD) of the Union European (EU). A Certificate of Compliance is available by contacting Patton Technical Support.

1.3 SERVICE

All warranty and non-warranty repairs must be returned freight prepaid and insured to Patton Electronics. All returns must have a Return Materials Authorization number on the outside of the shipping container. This number may be obtained from Patton Electronics Technical Service at **(301) 975-1007**, **<http://www.patton.com>**, or **support@patton.com**.

NOTE: Packages received without an RMA number will not be accepted.

Patton Electronics' technical staff is also available to answer any questions that might arise concerning the installation or use of your Model 222N9. Technical Service hours: **8AM to 5PM EST, Monday through Friday**.

2.0 GENERAL INFORMATION

Thank you for your purchase of this Patton Electronics product. This product has been thoroughly inspected and tested and is warranted for One Year parts and labor. If any questions or problems arise during installation or use of this product, please do not hesitate to contact Patton Electronics Technical Support at (301) 975-1007.

2.1 FEATURES

- Conforms to EIA RS-422 Standard
- Bi-directional data conversion
- Data Rates to 19.2 Kbps over two twisted pair
- No AC power required—draws operating power from RS-232 signals
- Passes transmit and receive data—handshaking lines looped back
- Convenient thumb screws on DB-9 (female) interface
- Ultra-miniature size (2.50" x 1.20" x 0.75")
- Twisted pair connection via strain relief, RJ-11 or RJ-45
- Made in the USA

2.2 DESCRIPTION

The Patton Model 222N9 RS-232 (EIA-574) to RS-422 interface converter allows asynchronous PCs, terminals and laptops employing the EIA-574 (RS-232/ DB-9) interface to communicate with devices using RS-422 balanced electrical signals. Facilitating bi-directional data conversion over two twisted pair, the Model 222N9 draws all necessary operating power from data and control voltages on the EIA-574 interface. The Model 222N9 supports data rates to 19.2 Kbps and distances to 4000 feet. All control signals are looped back at the EIA-574 interface.

The Model 222N9 is housed in an ultra-miniature ABS plastic enclosure measuring 2.5"L x 1.2" H x .75" W. Options for twisted pair connection on the RS-422 side include terminal block with strain relief, RJ-11 and RJ-45. The EIA-574 side is available with a choice of male or female DB-9 connector.

The surge protected Model 222N9S uses high speed avalanche diodes to intercept data line transient surges and shunt them safely to chassis ground. Compliant with IEC 801.5 level 2, 1kV, the 222N9S can protect itself and connected equipment from nearby lightning strikes, and other surges of electromagnetic radiation.

3.0 INSTALLATION

The Model 222N9 is easy to install and requires no pre-configuration. This section tells you how to properly connect the Model 222N9 to the RS-422 (twisted pair) and EIA-574 (DB-9) interfaces, and how to operate the Model 222N9.

3.1 CONNECTION TO THE RS-422 INTERFACE

The Model 222N9 supports data-only communication distances up to 4000 feet between itself and the RS-422 device. To function properly, the Model 222N9 *must* have two twisted pairs of metallic wire. These pairs must be dry, unconditioned metallic wire, between 19 and 26 AWG (the higher number gauges may limit distance somewhat).

For your convenience, the Model 222N9 is available with several different physical interfaces on the RS-422 side: RJ-11 jack, RJ-45 jack, and terminal blocks with strain relief.

3.1.1 TWISTED PAIR CONNECTION USING RJ-11 OR RJ-45

The RJ-11 and RJ-45 connectors on the Model 222N9's twisted pair interface are pre-wired for a standard TELCO wiring environment. The signal/pin relationships are shown below:

<u>RJ-11</u>	<u>SIGNAL</u>	<u>RJ-45</u>	<u>SIGNAL</u>
1-----	GND*	1-----	N/C
2-----	RCV-	2-----	GND*
3-----	XMT+	3-----	RCV-
4-----	XMT-	4-----	XMT+
5-----	RCV+	5-----	XMT-
6-----	GND*	6-----	RCV+
		7-----	GND*
		8-----	N/C

* Connection to Ground is Optional

When connecting two Model 222N9s it is necessary to use a "cross over" cable. The diagram below shows how a cross over cable should be constructed for an environment where both Model 222N9s use a 6-wire RJ-11 connector. Similar logic should be followed when using RJ-45 connectors or a combination of the two.

<u>SIGNAL</u>	<u>PIN#</u>	<u>PIN#</u>	<u>SIGNAL</u>
GND*	1	6	GND
RCV-	2	4	XMT-
XMT+	3	5	RCV+
XMT-	4	2	RCV-
RCV+	5	3	XMT+
GND*	6	1	GND

*Connection to Ground is Optional

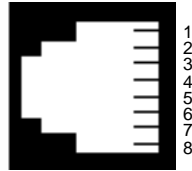
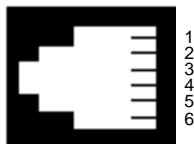

3.1.2 TERMINAL BLOCK TWISTED PAIR CONNECTION

If your application requires you to connect one or two pairs of bare wires to the Model 222N9, you will need to access the internal terminal blocks. The instructions on the following pages will tell you how to open the case, connect the bare wires to the terminal blocks, and fasten the strain relief collar in place so that the wires won't pull loose.

Note: The terminal block configurations are different for the 222N9M (male) and 222N9F (female).

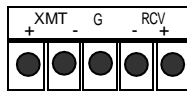

222N9M

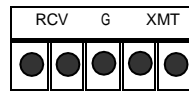

222N9F

1. Open the unit by gently inserting a screw driver between the DB-9 connector and the lip of the plastic case (See below). You don't have to worry about breaking the plastic, but be careful not to bend the D-sub connector.

(Continued)

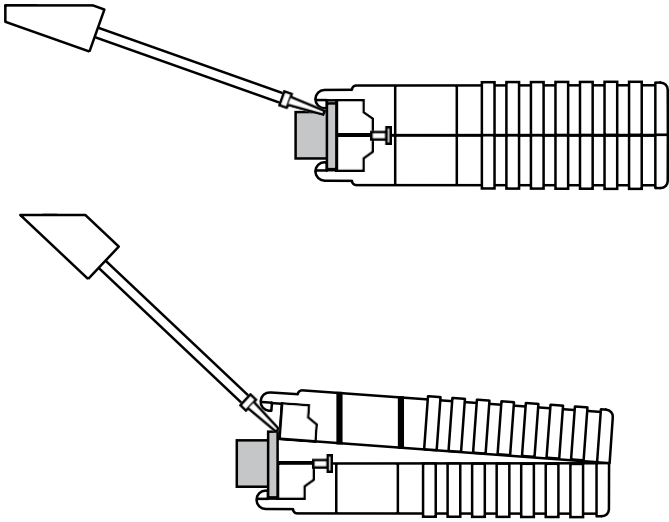

Once the unit has been opened, you will be able to see the terminal block located at the rear of the PC board.

2. Strip the outer insulation from the twisted pairs about one inch from the end.

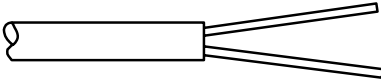

3. Strip back the insulation on each of the 2 twisted pair wires about .25".

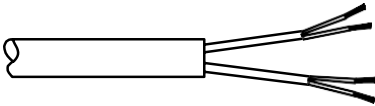

4. Connect *one pair* of wires to XMT+ and XMT- (transmit positive and negative) on the terminal block, making careful note of which color is positive, and which color is negative.

5. Connect the *other pair* of wires to RCV+ and RCV- (receive positive and negative) on the terminal block, again making careful note of which color is positive, and which color is negative.

Ultimately, you will want to construct a two pair cross over cable that makes a connection with the RS-422 device as shown below:

<u>Model 222N9</u>	<u>RS-422 Device</u>
XMT+	RCV+
XMT.....	RCV-
RCV+	XMT+
RCV.....	XMT-

6. If there is a shield around the telephone cable, it may be connected to "G" on the terminal block. We recommend connecting the shield at the computer end only to avoid ground loops. A ground wire is *not necessary* for proper operation of the Model 222N9.

7. When you finish connecting the wires to the terminal block, the assembly should resemble the diagram below:

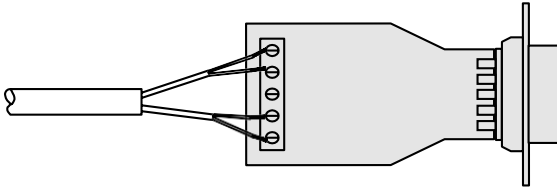

8. Place the 2 halves of the strain relief assembly on either side of the telephone wire and press together very lightly. Slide the assembly so that it is about 2 inches from the terminal posts and press together firmly. If your cable diameter is too small or too large for our strain relief, please contact our technical support. We have strain relief assemblies to accommodate most cable diameters.

(Continued)

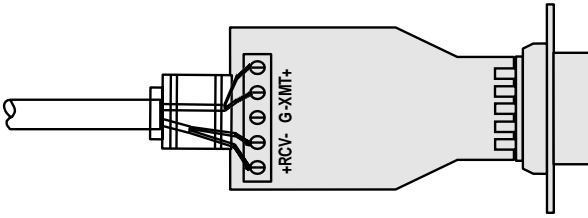

9. Insert the strain relief assembly with the wire going through it into the slot in the bottom half of the modem case and seat it into the recess in the case. (If the telephone wire is too thin to be held by the strain relief assembly, you will need to order a different sized strain relief. Call Patton's Sales Department at (301) 975-1000.)

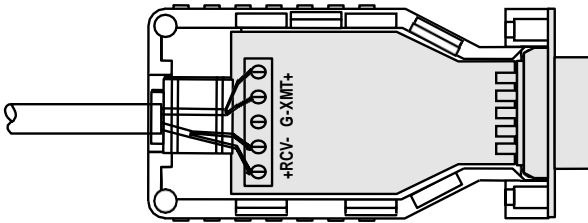

10. BEND the top half of the case as necessary to place it over the strain relief assembly. Do not snap the case together yet.

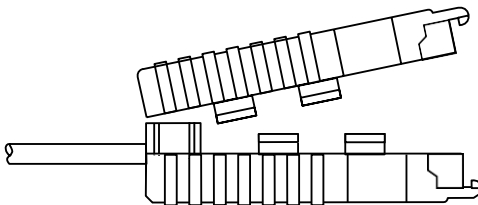

11. Insert one captive screw through a saddle washer and then insert the captive screw with the washer on it, through the hole in the DB-25 end of the case. Snap that side of the case closed. Repeat the process for the other side. This completes the cable installation process.

3.2 CONNECTION TO THE EIA-574 (RS-232) INTERFACE

The Model 222N9 is configured as a DCE, and is wired according to the EIA-574 standard.

EIA-574 Standard

<u>DB-9</u>	<u>SIGNAL</u>
3 -----	TD
2 -----	RD
7	RTS
8	CTS
1 -----	CD
4 -----	DTR
6 -----	DSR
5 -----	SG/FG

Due to its small size, the Model 222N9 is able to plug directly into the serial port of your EIA-574 DTE device (PC, laptop, etc.). If you must use a cable to connect the Model 222N9 to the DTE device, make sure that it is a *straight through* cable of the shortest possible length—we recommend 6 ft or less.

3.3 OPERATING THE MODEL 222N9

Once the Model 222N9 is properly installed, it should operate transparently—as if it were a standard cable connection. Operating power is derived from the EIA-574 data and control signals; there is no "ON/OFF" switch. All data from the EIA-574 interface, including X-ON/X-OFF flow control information, is passed straight through. Any hardware flow control signals are looped back at the interface and are not passed between the short hauls.

APPENDIX A

PATTON MODEL 222N9 SPECIFICATIONS

Transmission Format: Asynchronous

Data Rate: 0 to 19,200 bps (no strapping)

Control Signal: CTS (Pin 8) turns ON immediately after the terminal raises RTS (Pin 7). DSR (Pin 6) and DCD (Pin 1) turn ON immediately after the terminal raises DTR (Pin 4).

Transmit Line: 4 wire, unconditioned line (2 twisted pairs)

Transmit Mode: Full Duplex, 4-wire

Transmit Level: 0 dBm

Line Connection: RJ-11 or RJ-45 jack or 5 screw terminal posts (4 wires and 1 ground) and a strain relief insert. Works well with data signals only.

Power Supply: None required, uses ultra low power from EIA data and control signals

Surge Protection: Compliant with IEC 801.5 level 2, 1kV (Model 222N9S Only)

Size: 2.50" x 1.2" x .75"

APPENDIX B

PATTON MODEL 222N9 CABLE RECOMMENDATIONS

The Patton Model 222N operates at frequencies of 20kHz or less and has been performance tested by Patton technicians using twisted-pair cable with the following characteristics:

<u>Wire Gauge</u>	<u>Capacitance</u>	<u>Resistance</u>
19 AWG/.9mm	83nf/mi or 15.72 pf/ft.	.0163 Ohms/ft.
22 AWG/.6mm	83nf/mi or 15.72 pf/ft.	.0326 Ohms/ft.
24 AWG/.5mm	83nf/mi or 15.72 pf/ft.	.05165 Ohms/ft.

To gain optimum performance from the Model 222N, please keep the following guidelines in mind:

- *Always* use **twisted pair** wire—this is not an option.
- Use twisted pair wire with a capacitance of 20pf/ft or less.
- Avoid twisted pair wire thinner than 26 AWG (i.e. avoid higher AWG numbers than 26)
- Use of twisted pair with a resistance greater than the above specifications may cause a reduction in maximum distance obtainable. Functionality should not be affected.
- Environmental factors too numerous to mention can affect the maximum distances obtainable at a particular site. Use “maximum distance” figures as a **general guideline only**.

APPENDIX C

PATTON MODEL 222N9 PIN ASSIGNMENTS

EIA-574 (RS-232) Interface (DB-9 Connector)

EIA-574 Interface

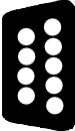
Signal/Voltage Source	Signal Designations		Signal Designations	Signal/Voltage Source
DCE	Data Set Ready 6		1 Receive Line Signal Detector	DCE
DTE	Request To Send 7		2 Received Data	DCE
DCE	Clear To Send 8		3 Transmitted Data	DTE
DCE	Ring Indicator 9		4 Data Terminal Ready	DTE
			5 Ground/common Return	Common

EIA-422 Interface (RJ-11 Female Connector)

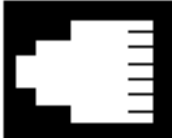
RJ-11 (6 Pin)	SIGNAL/PIN #
	1 - (G) Ground 2 - (RCV-) Receive Data - 3 - (XMT+) Transmit Data - 4 - (XMT-) Transmit Data - 5 - (RCV+) Receive Data + 6 - (G) Ground

EIA-422 Interface (RJ-45 Female Connector)

RJ-45 (8 Pin)	SIGNAL/PIN #
	1 - no connection 2 - (G) Ground 3 - (RCV-) Receive Data - 4 - (XMT+) Transmit Data + 5 - (XMT-) Transmit Data - 6 - (RCV+) Receive Data + 7 - (G) Ground 8 - no connection

NOTE: Signals XMT+ and XMT- are the EIA-422 "A" and "B" transmitters, respectively; Signals RCV+ and RCV- are the EIA-422 "A" and "B" receivers, respectively.

Dear Valued Customer,

Thank you for purchasing Patton Electronics products! We do appreciate your business. I trust that you find this user manual helpful.

We manufacture one of the widest selections of data communications products in the world including CSU/DSU's, network termination units, powered and self-powered short range modems, fiber optic modems, interface converters, baluns, electronic data switches, data-line surge protectors, multiplexers, transceivers, hubs, print servers and much more. We produce these products at our Gaithersburg, MD, USA, facility, and can custom manufacture products for your unique needs.

We would like to hear from you. Please contact us in any of the following ways to tell us how you like this product and how we can meet your product needs today and in the future.

Web:	http://www.patton.com
Sales E-mail:	sales@patton.com
Support E-mail:	support@patton.com
Phone - Sales	(301) 975-1000
Phone - Support	(301) 975-1007
Fax:	(301) 869-9293
Mail:	Patton Electronics Company 7622 Rickenbacker Drive Gaithersburg, MD 20879 USA

We are committed to a quality product at a quality price. Patton Electronics is ISO 9001 certified. We meet and exceed the highest standards in the industry (CE, UL, etc.).

It is our business to serve you. If you are not satisfied with any aspect of this product or the service provided from Patton Electronics or its distributors, please let us know.

Thank you.

Burton A. Patton
Vice President

P.S. Please tell us where you purchased this product.

**Copyright © 1997
Patton Electronics Company
All Rights Reserved**

**Industrial Communication Products Ltd
Tel: +44(0) 203 086 9569**

**Web: www.industrialcomms.com
Email: sales@industrialcomms.com**