



# 5" CAR BABY MONITOR

HD Wireless Baby Monitor For Your Car

WP ITM. TT002



Care & Use Instructions for TT002B / TT002W

**Important, retain for future reference:  
Read carefully**

BC

IF YOU ARE EXPERIENCING ANY ISSUES WITH THE PRODUCT DURING OPERATION, DO NOT RETURN THE PRODUCT TO THE STORE. CONTACT TINY TRAVELER™ DIRECTLY FOR INSTRUCTIONS ON HOW TO RETURN/EXCHANGE THE PRODUCT. PLEASE KEEP YOUR ORIGINAL RECEIPT AS PROOF OF PURCHASE MUST BE PROVIDED. FULL WARRANTY INFORMATION IS INCLUDED IN THIS USER MANUAL.

Tiny Traveler™  
A Horizon Brands Company  
Tel.:866.294.9244

Email us at: [info@mytinytraveler.com](mailto:info@mytinytraveler.com)

# TABLE OF CONTENTS

1. Introduction .....	4
2. Important Safety Information .....	4
3. Package Contents .....	6
4. Product Specifications .....	7
5. Product Overview .....	7
6. Tiny Traveler™ Monitor & Camera LED Indicators .....	8
7. Recording Time .....	9
8. Technical Specifications .....	9
9. Installation Guide .....	10
10. Connect to Power .....	12
11. Initial Setup .....	13
12. Pairing the Camera .....	14
13. Configuration & Menu Setting .....	15
14. Safety Information .....	18
15. Maintenance & Warranty .....	18
16. General Information .....	20

# 1. INTRODUCTION

Thank you for purchasing the Tiny Traveler™ 5" Car Baby Monitor. Designed by our family with your family in mind. Tiny Traveler™ is set out to create simplified tech to keep your little ones safer. The 5" Car Baby Monitor is essential for any trips in the car or at home to safely monitor your baby. It's packed with features such as a HD Touch Screen Monitor, night vision, and the ability to view rear or forward facing car seats. Whether it's a quick run to the grocery store, driving to the park or road trips, you'll be able to drive safely and keep eyes on your baby wherever you go. Please read all of the installation instructions carefully before installing your Monitor. Improper installation or use will void the manufacturer's warranty. Welcome to the Tiny Traveler™ family!

# 2. IMPORTANT SAFETY INFORMATION

Thank you for purchasing the 5" Car Baby Monitor. Tiny Traveler™ is dedicated to safe driving practices and strives to limit distractions for drivers. The 5" Car Baby Monitor is intended to aid in helping drivers traveling with a baby remain focused on driving safely and still have the peace of mind of being able to glance at their baby in the back seat. A driver's main focus should always be on the road and their surroundings. The 5" Car Baby Monitor allows the driver to monitor the baby's activities without having to turn around and take their eyes off the road. Please read all of the installation instructions carefully before installing your Monitor. Improper installation or use will void the manufacturer's warranty.

- Consult local laws and regulations for any restriction on installation or use and obey all legal requirements for safe vehicle operation, including those related to distracted driving.
- A failure to read and follow these warnings and instructions may result in a serious accident, including damaged property or a serious injury, including loss of life. Please keep this user manual for further reference.
- The 5" Car Baby Monitor is a system that is intended as an aid to monitor your baby while you are driving by allowing for quick glances at your baby while facing forward and without having to turn around and take your eyes off the road. It is not a substitute for responsible and proper adult supervision of children and should not be used as such.
- Make sure that at no time does the 5" Car Baby Monitor Camera or cables come in any contact or within reach of your baby.
- Check your local laws and regulations about having a Monitor with live video feed while driving. Please take note that the Monitor will show the image taken by the Camera continuously as long as they are

connected, the car is running, and the Monitor is powered on.

- This product will only provide images of items that are within the field of view of the Camera. Thus, it is imperative that the Camera should be kept clean and unobstructed. And should be mounted so that its field of view includes the entire area around the car seat.
- Note that the image in the Monitor will be a reversed image of the baby.
- The 5" Car Baby Monitor is made for use indoor or inside your vehicle. It is not meant for outdoor use.
- Do not get any of the Tiny Traveler™ 5" Car Baby Monitor components wet or exposed to moisture.
- At any time, do not attempt to open the Monitor or Camera, or use different cables other than the ones provided with the original packaging.
- During installation, do not have the baby in the car. The car seat should be correctly mounted in the car as required by law. There is no need to have the baby in the car while the 5" Car Baby Monitor is installed, and should be kept away as a precaution.
- Before mounting the Camera, check your local laws and regulations regarding where the device is legally allowed to be mounted.
- The Monitor should be mounted securely as instructed. At no time should it be loose or not fixed to the dashboard or windshield.
- The Camera should be mounted securely as instructed. At no time should it be loose or not fixed in place with the mounts provided.
- DO NOT attach the Camera to the car seat. DO NOT lay the Camera loosely in the car seat.
- This system is powered by plugging the adapter into the 12/24V adapter in your vehicle or USB media ports. Do not attempt to use any other power source or cables to operate this system.
- The Tiny Traveler™ 5" Car Baby Monitor is not a toy. At no time should children be allowed to play with it. It should only be operated by adults who have read the safety and operating instructions listed in this manual.
- This product contains small parts. Adult installation is required. Exercise care when unpacking and assembling the product.
- Only use the Home Adapter, USB Charger or any attachments as provided or sold separately by the manufacturer.

### 3. PACKAGE CONTENTS

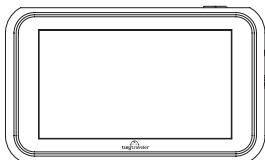

5" Touch Screen LCD  
with Built-in Battery

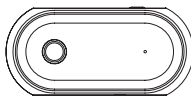

Car Camera

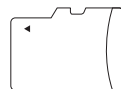

16GB MicroSD Card  
(Class 10)

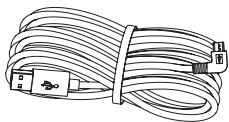

2 x 9.8' / 3m  
Micro USB Power Cable

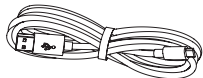

33" / 84cm  
Micro USB Cable  
(With Data Pin)



Tiny Traveler™  
On Board Sticker

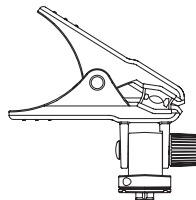

Camera  
Spring Loaded Clamp

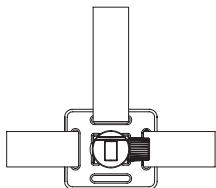

Camera Headrest Mount  
with Straps

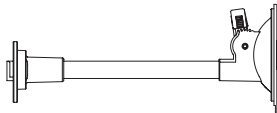

Monitor  
Windshield Mount

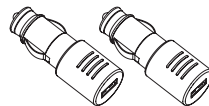

2 x USB Adapter  
(Output 5V DC 2A)

## 4. PRODUCT SPECIFICATIONS

<b>Frequency:</b>	2.4 GHz
<b>Camera Resolution:</b>	HD 720P
<b>Camera Viewing Angle:</b>	FOV(H) 79°
<b>Operating Temperature:</b>	14°F ~ 122°F (-10°C ~ 50°C)
<b>Operating Voltage:</b>	DC 5V (Micro USB)
<b>Maximum Signal Range:</b>	33 Feet / 10 Meters (without interference or obstruction)

## 5. PRODUCT OVERVIEW

### Car Camera

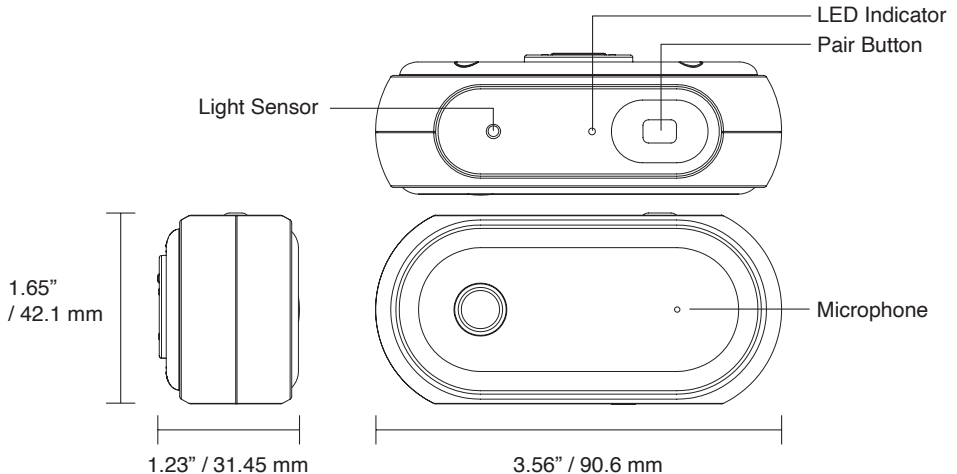

## 5" Touch Screen LCD Monitor

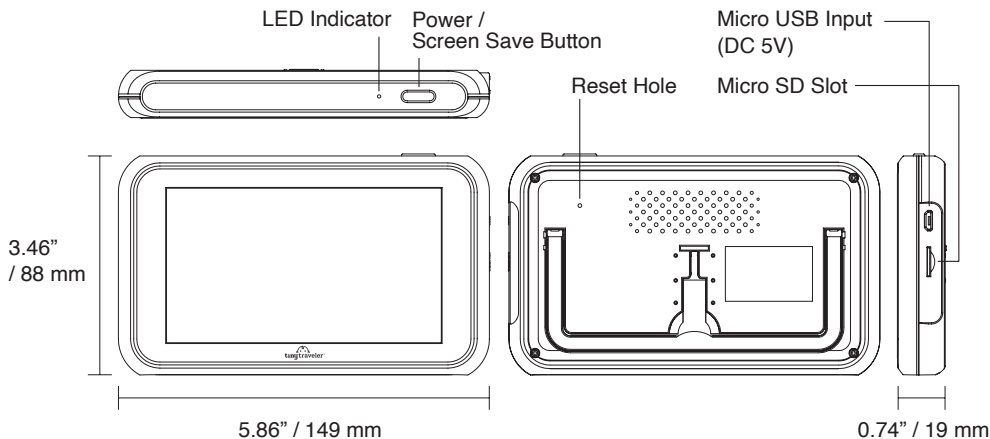

## 6. TINY TRAVELER™ MONITOR & CAMERA LED INDICATORS

Power / Mode Status	5" Touch Screen Monitor	Camera
Power On	Blue LED light stays on. Monitor powers on when the engine is turned on. Alternatively, press and hold the power button for more than 2 seconds to power on the Monitor.	Blue LED light stays on.
Low Voltage Indication	Red LED light flashes.	N/A
Power Off	LED light is off. Press and hold the power button for more than 2 seconds to power off the Monitor.	LED light is off.
Screen Save Mode	Blue LED light stays on.	Blue LED light stays on.
Pairing Mode	Blue LED light stays on.	Blue LED light flashes.
Charging	Red LED light stays on and then turns off when fully charged.	N/A



## 7. RECORDING TIME

Memory Card Capacity	Maximum Recording Time (1 Minute Loop Record)	Maximum Recording Time (3 Minutes Loop Record)	Maximum Recording time (5 Minutes Loop Record)
<b>16GB</b>	Up to 890 minutes	Up to 890 minutes	Up to 890 minutes
<b>32GB</b>	Up to 1,000 minutes	Up to 1,900 minutes	Up to 1,900 minutes
<b>64GB</b>	N/A	Up to 3,000 minutes	Up to 3,970 minutes
<b>128GB</b>	N/A	N/A	Up to 5,000 minutes

**NOTE:** If you use your own MicroSD card please insert it into the Touch Screen Monitor and use the format function under the system settings page (refer to page 16) before first use. DO NOT format the MicroSD card using other devices.

## 8. TECHNICAL SPECIFICATIONS

### Memory Management

Memory Card Capacity	System Reserve	Available Memory for Video and Photo
<b>16GB</b>	2GB	12.5GB
<b>32GB</b>	2GB	26.8GB
<b>64GB</b>	2GB	55.6GB
<b>128GB</b>	2GB	106GB

## 9. INSTALLATION GUIDE

### Camera Placement and Operation

Before selecting which camera mount to use, it is best to determine where in the car the Camera will best be placed in order to capture the image of your baby's car seat. Make sure the Camera is not located near the airbag. If your car seat is rear or forward facing you have several options:

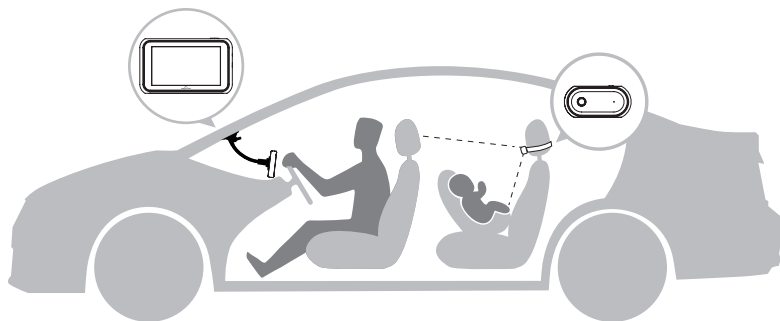

#### Option 1: Headrest Mount with Straps

Use the Headrest Mount with Straps to attach to the headrest of the front or back seat by pulling the vertical and horizontal straps and securing with the plastic ladder lock buckle. The Camera should be mounted tightly to the headrest so that the Camera is stable. The Camera can then be adjusted to angle accordingly to capture the entire car seat. Adjust the angle of the Camera by loosening the nut and rotate to your desired angle.

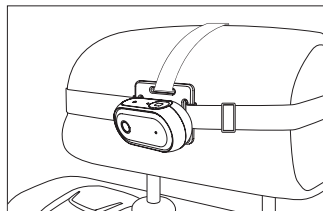
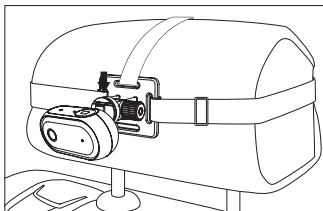
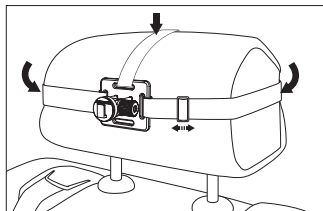

## Option 2: Spring Loaded Clamp

To mount the Camera using the Spring Loaded Clamp, place the clamp around the headrest pole that best suits the Camera placement that is needed. Attach the Camera on the bracket of the clamp. Adjust the angle of the Camera by loosening the nut and rotate to your desired angle.

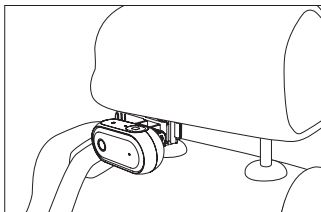
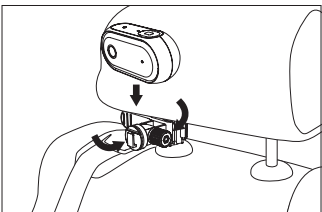
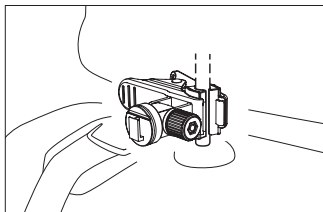

## Monitor Placement and Operation

Select a suitable position for the mount and clean the windshield with a dry/clean cloth.

1. Remove the protective plastic film from the suction cup and attach the Windshield Mount to the windshield. Push the lever down to secure the mount while holding the suction cup onto the glass.
2. Attach the Monitor to the Windshield Mount as shown below. For optimal ease of use, we suggest mounting the Monitor low and near the center of your windshield. You should be able to safely glance at your baby and not need to turn your head from facing forward. Adjust the tube of the Windshield Mount so the base of the Monitor is touching the surface of the dashboard in order to reduce rattling vibration. Be sure that the Monitor does not obstruct your view while driving.

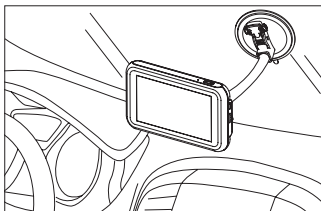
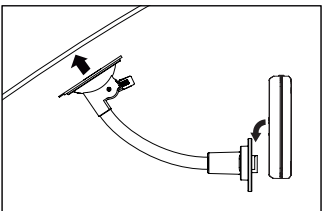
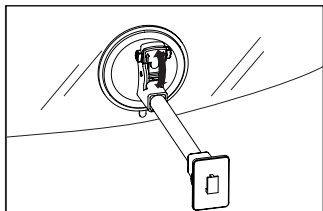

## 10. CONNECT TO POWER

### Powering the Camera and Monitor

The 5" Car Baby Monitor comes with two USB Power Adapters and two 9.8' (3m) Micro USB Power Cables which can be plugged into any available sockets in your vehicle.

Starting with the power cable at the base of the Camera, run and tuck the cable to the available socket you wish to plug into. Ensure that the cable is not in contact with the car seat or within reaching distance of the baby. It is recommended to tuck the cable behind the seat, lining, rug or panels in order to keep it from tangling or getting caught in any object.

Once you have the Camera secure in its mount, and the power cable tucked carefully out of the way, you can plug the power cable into the USB power adapter, and then plug into the 12/24V socket. Make sure the adapter is pushed all the way into the socket.

**NOTE:** If your vehicle has USB media ports you can plug the USB cables directly into those ports without the adapters.

Once the Camera and Monitor are both plugged in and powered on, the Monitor will automatically show the image from the Camera.

Pairing is not necessary as the unit has already been paired. If you are not able to connect the Camera, please try to pair the Camera (refer to the 5 steps on page 14).

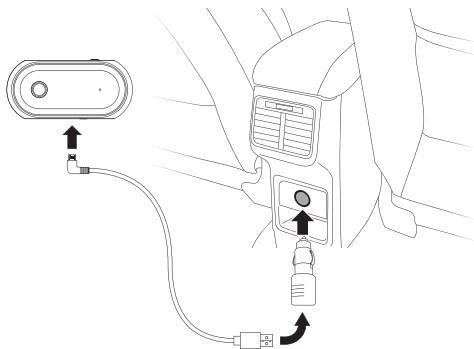
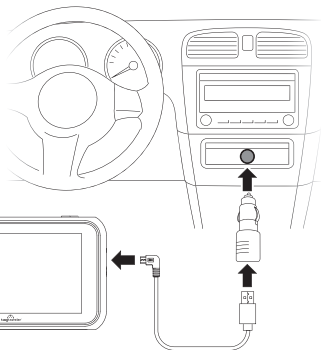

## Usage Precautions

Many vehicles provide constant power to the 12/24V outlet. If your outlet provides constant power, please remember to unplug the LCD Touch Screen Monitor and Camera when not in use to avoid draining of the vehicle's battery.

### MicroSD Card (Pre-installed)

**NOTE:** If you use your own MicroSD card please insert it into the Monitor and use the format function under the system settings page (refer to page 16) before first use. DO NOT format the MicroSD card using other devices.

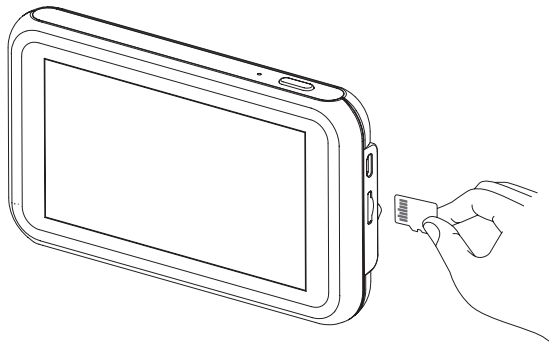

## 11. INITIAL SETUP

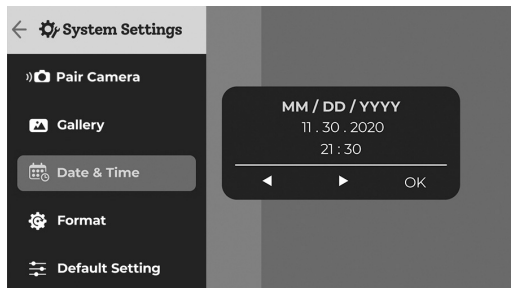

The default settings have been carefully selected to allow you to use your Baby Monitor without the need to change any settings. However, you should set the date and time during your first time using the Baby Monitor as this will affect the time stamp on all recorded media files.

To set the date and time, go to System Settings > Date & Time.



## 12. PAIRING THE CAMERA

No camera pairing is needed as the Tiny Traveler™ Car Camera is already paired with the 5" LCD Monitor. However, if you purchase the Tiny Traveler™ Add-On Camera (TTCAMB / TTCAMW, sold separately), you need to pair the Add-On Camera by following these steps:

1. Tap  **System Setting**.
2. Tap  **Pair Camera**.
3. Choose the Camera you wish to pair and click to pair.
4. On the Camera hold down the pair button for 5 secs until the pair indicator light blinks blue.
5. Pairing is done when you see **Pair OK**. You should see the image from the Car Camera.

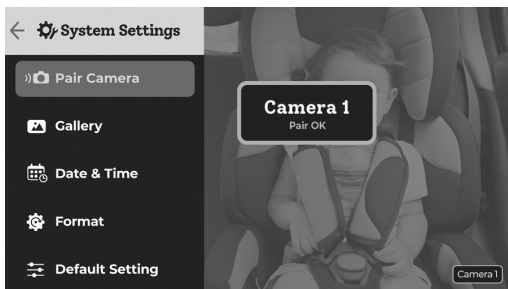
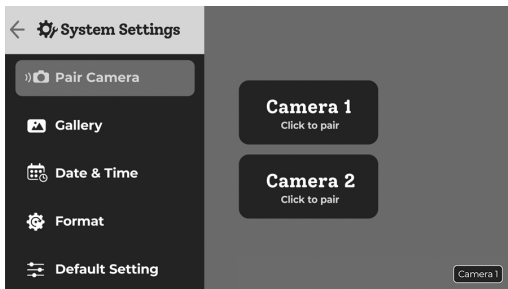
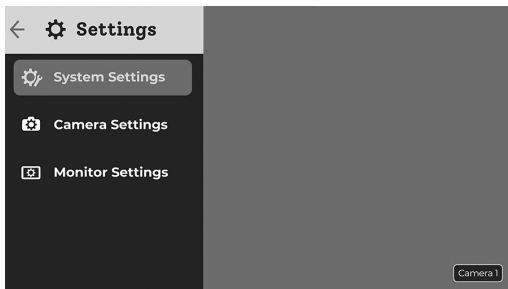

## 13. CONFIGURATION AND MENU SETTING

The 5" LCD Monitor operates by touch screen; all the functions can be done by tapping and swiping on the screen. Tap on the **i** **Tips** icon for on-screen instructions.

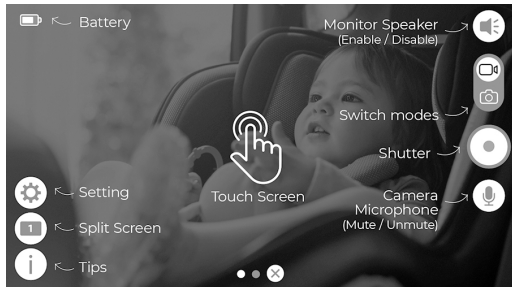

### Split Screen

If you purchase the Tiny Traveler™ Add-On Camera (TTCAMB / TTCAMW, sold separately), you can tap the **1 2** **Split Screen** icon to switch between different screen modes after you pair the Add-On Camera with the Monitor.

**NOTE:** Visit [mytinytraveler.com](http://mytinytraveler.com) for more information on where you can purchase the Tiny Traveler™ Add-On Camera.

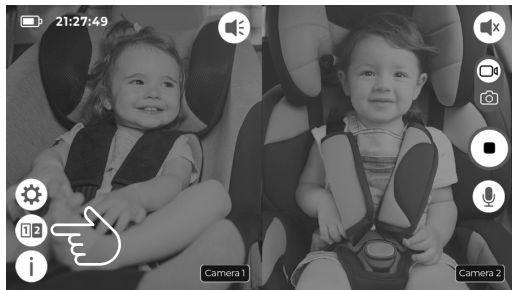

### Battery Indicator

The battery indicator shows the battery level of the Touch Screen LCD Monitor.

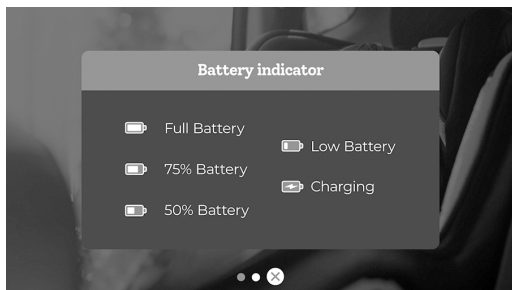

## Menu Tree:

See below for the settings to be found under each submenu:

System Settings	Camera Settings	Monitor Settings
Pair Camera	Contrast	Loop Record
Gallery	Saturation	Warning Image
Date & Time	Rotate Camera	Screen Save
Format	Voice Activation	Monitor Brightness
Default Setting	Night Vision	Language

## System Settings

1. Pair Camera (see page 14)
2. Gallery - Choose video or photo gallery.
3. Date & Time (see page 13)
4. Format
  - Erase all data on the MicroSD card.
  - **NOTE:** DO NOT format the MicroSD card using other devices.
5. Default Settings
  - To reset all settings to their defaults.



Video Gallery



## Camera Settings

**NOTE:** Camera settings are not available in Split Screen Mode. You must switch to Camera 1 or Camera 2 by tapping the Split Screen Mode Icon before configuring any camera settings.

1. Contrast - Swipe the slider to adjust screen contrast.
2. Saturation - Swipe the slider to adjust Car Camera color saturation.
3. Rotate Camera - Rotate the screen orientation if your mounting angle requires you to flip the Car Camera.
4. Voice Activation - Swipe the slider to adjust to your desired level of voice sensitivity. The higher the sensitivity the Car Camera will more likely detect sound in the surroundings and wake up the screen from screen save mode. Voice activation can also be turned off.

## Monitor Settings

1. Loop Record - Select the duration of each recorded footage.
2. Warning Image - Turn the Warning Notification On/Off. Tap the  **Warning Notification** icon on a pre-recorded photo to set it as the background image of the warning notification.
3. Screen Save - Monitor screen will be turned off after a chosen period of time. Alternatively, press the Monitor power button once to enter screen save mode. You can wake up the Monitor by tapping on the screen or voice activation.
4. Monitor Brightness - Swipe the slider to adjust brightness of the Monitor.

5. Night Vision - Swipe the slider to adjust night vision exposure level or to disable night vision.

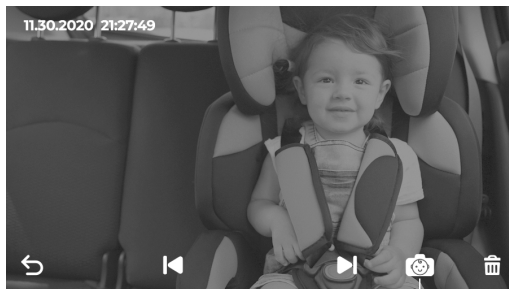

Tap this icon to set the photo as the background image of the warning notification. Tap the icon on the same photo again to switch back to the default photo.

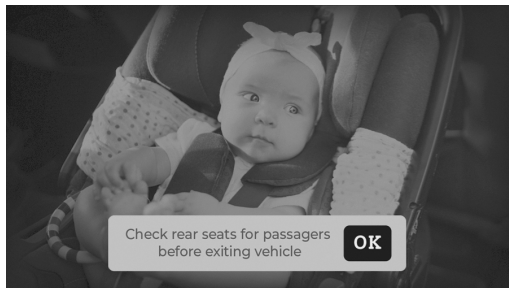

## Warning Notification

5. Language - Set your preferred language.

## 14. SAFETY INFORMATION

### IMPORTANT SAFETY INSTRUCTIONS

1. SAVE THESE INSTRUCTIONS – This manual contains important safety and operating instructions for USB Adapter Model CHR05-01-USB.
2. Before using USB Adapter, read all instructions and cautionary markings on Camera and Monitor.
3. Do not expose charger to rain, moisture, or snow.
4. Use of an attachment not recommended or sold by the manufacturer may result in a risk of fire, electric shock, or injury to persons.
5. To reduce risk of damage to cigarette lighter connector and cord, pull by cigarette lighter connector rather than cord when disconnecting charger.
6. Make sure cord is located so that it will not be stepped on, tripped over, or otherwise subjected to damage or stress.
7. Do not operate charger with damaged cord or cigarette lighter connector – replace it immediately.
8. Do not operate charger if it has received a sharp blow, been dropped, or otherwise damaged in any way; take it to a qualified serviceperson.
9. Do not disassemble charger; take it to a qualified serviceperson when service or repair is required. Incorrect reassembly may result in a risk of electric shock or fire.
10. To reduce risk of electric shock, unplug charger before attempting any maintenance or cleaning. Turning off controls will not reduce this risk.
11. Make sure cord is located so it will not be stepped on, tripped over, or otherwise subjected to damage or stress.

**WARNING:** A failure to read and follow these warnings and instructions may result in a serious accident, including damaged property or a serious injury, including loss of life.

## 15. MAINTENANCE & WARRANTY

### Tiny Traveler™ Limited Warranty

Tiny Traveler™ warrants, to the original purchaser, that its products are free from defects in material and workmanship for 1 year from the date of original purchase. Where permitted by law, Tiny Traveler's liability shall be limited to that set forth in this limited express warranty. This limited express warranty shall be the exclusive remedy of the purchaser and Tiny Traveler™ makes no other warranty of any kind aside from the limited express warranty stated above.

**NOTE:** Warranty only applies for North American customers of purchases made in North America. Register your Tiny Traveler™ products at [www.mytinytraveler.com](http://www.mytinytraveler.com) within 30 days of purchase to redeem your 1 year warranty.

## **Conditions of Warranty**

If during the 1 year warranty period your new product is found to be defective, Tiny Traveler™ will repair such defect, or replace the product, without charge for parts or labor subject to the following conditions:

- All repairs must be performed by Tiny Traveler™.
- All warranty claims must be accompanied by a copy of the sales receipt or bill of sale.
- The equipment must not have been altered or damaged through negligence, accident, improper operation, or failure to follow the product instructions for installation, use, or care.
- The replacement of parts is excluded from the warranty when replacement is necessary due to normal wear and tear.
- Repair or replacement parts supplied by Tiny Traveler™ under this warranty are protected only for the unexpired portion of the original warranty.
- This is a “repair or replace” warranty only, and does not cover the costs incurred for the installation, removal or reinstallation of the product, or damage to any device or vehicle.

## **Owner’s responsibilities:**

Tiny Traveler™ will make every effort to provide warranty service within a reasonable period of time. SHOULD YOU HAVE ANY QUESTIONS ABOUT SERVICE RECEIVED OR IF YOU WOULD LIKE ASSISTANCE IN OBTAINING SERVICE, PLEASE CALL TOLL FREE 1.866.294.9244 DURING REGULAR BUSINESS HOURS MONDAY THROUGH FRIDAY 8:00 AM TO 5:00PM.

**NOTE:** Toll Free # is for North America Customers ONLY.

If at that time it is determined that a replacement unit is needed, the support representative will issue a Return Authorization and instruct on how to get a new unit. Tiny Traveler™ makes no other warranty of any kind aside from the limited express warranty stated herein.

**DISCLAIMER OF WARRANTIES, INCLUDING WARRANTY OF MERCHANTABILITY AND WARRANTY**

OF FITNESS FOR PARTICULAR PURPOSE: EXCEPT AS SPECIFICALLY SET FORTH HEREIN, NO WARRANTY OR REPRESENTATION, EXPRESS OR IMPLIED, IS MADE AS TO THE 5" CAR BABY MONITOR. EXCEPT AS EXPRESSLY SET FORTH HEREIN, TINY TRAVELER™ AND/OR ITS AFFILIATES EXPRESSLY DISCLAIMS, WITHOUT LIMITATION, ANY STATUTORY WARRANTIES AND ALL IMPLIED WARRANTIES, INCLUDING ANY IMPLIED WARRANTY OF MERCHANTABILITY OR FITNESS FOR A PARTICULAR PURPOSE.

Tiny Traveler™ and/or its affiliates do not guarantee or promise that the user of the 5" Car Baby Monitor will not be in an accident or otherwise not collide with an object and/or person. Our 5" Car Baby Monitor is not intended in any way to be a substitute for careful and cautious driving or for the consistent adherence to all applicable traffic laws and motor vehicle safety regulations.

Tiny Traveler™ and/or its affiliates are not responsible for a user's intended or actual use of the 5" Car Baby Monitor. In no event shall Tiny Traveler™ and/or its affiliates have any liability for any losses (whether direct or indirect, in contract, tort or otherwise) incurred in connection with the 5" Car Baby Monitor, including but not limited to damaged property, personal injury and/or loss of life. Neither shall Tiny Traveler™ and/or its affiliates have any liability for any decision, action or inaction taken by any person in reliance on the 5" Car Baby Monitor, or for any delays, inaccuracies and /or errors in connection with the 5" Car Baby Monitor and its functioning.

Tiny Traveler™ and/or its affiliates shall have no responsibility or liability for damage and/or injury resulting from accidents occurring with vehicles having the installed, and Tiny Traveler™ and/or its affiliates, the manufacturer, distributor and seller shall not be liable for any injury, loss or damage, incidental or consequential, arising out of the use or intended use of the product.

## **16. GENERAL INFORMATION**

### **Customer Service/Contact**

IF YOU ARE EXPERIENCING ANY ISSUES WITH THE PRODUCT DURING OPERATION, DO NOT RETURN THE PRODUCT TO THE STORE. CONTACT TINY TRAVELER™ DIRECTLY FOR INSTRUCTIONS ON HOW TO RETURN / EXCHANGE THE PRODUCT.

### **FCC Compliance Statement:**

This device complies with Part 15 of the FCC rules. Operation is subject to the following two conditions: (1) This device may not cause harmful interference, and (2) this device must accept any interference received, including interference that may cause undesired operation.

**WARNING:** Changes or modifications to this unit not expressly approved by the party responsible for compliance could void the user's authority to operate the equipment. The manufacturer is not responsible for any radio or TV interference caused by unauthorized modifications or change to this equipment. Such modifications or change could void the user's authority to operate the equipment.

**NOTE:** This equipment has been tested and found to comply with the limits for Class B digital device, pursuant to part 15 of the FCC Rules. These limits are designed to provide reasonable protection against harmful interference in a residential installation. This equipment generates, uses and can radiate radio frequency energy and, if not installed and used in accordance with the instructions, may cause harmful interference to radio or television reception, which can be determined by turning the equipment off and on, the user is encouraged to try to correct the interference by one or more of the following measures:

- Reorient or relocate the receiving antenna.
- Increase the separation between the equipment and the receiver.
- Connect the equipment into an outlet on a circuit different from that to which the receiver is connected.
- Consult the dealer or an experienced radio/TV technician for help.

The device has been evaluated to meet general RF exposure requirement. To maintain compliance with FCC/IC's RF exposure guidelines, this equipment should be installed and operated with a minimum distance of 20cm between the radiator and your body.

### **Strangulation Hazard:**

Children have STRANGLED in cords. Keep the unit and cord more than 3 feet from the crib or car seat and out of baby's reach. NEVER place Camera or cords within the crib or car seat. Secure the cord more than 3 feet away from the baby's reach.

**Battery Disposal:**

The battery is self-contained and not consumer replaceable. The battery must be disposed of properly when it no longer holds a charge. Proper charging practices will increase the life of the product. For information on battery recycling, call toll-free 800-822-8837.

Tiny Traveler™ 5" Car Baby Monitor

HD Wireless Baby Monitor For Your Car

TT002

Responsible Party:

Tiny Traveler™

2975 Red Hill Ave., Ste. 100, Costa Mesa, CA 92626

Tel: 866-294-9244





A Horizon Brands Company  
2975 Red Hill Ave., Ste. 100,  
Costa Mesa, CA 92626  
1.866.294.9244

info@mytinytraveler.com  
© 2021 ADC Solutions Auto, LLC.  
All rights reserved.

[www.mytinytraveler.com](http://www.mytinytraveler.com)



@mytinytraveler

ML-532387\_V1