



tinytraveler™

ADD-ON CAMERA

Perfect For Your Growing Family!

WP ITM. TT002



Care & Use Instructions for TTCAMB / TTCAMW

**Important, retain for future reference:
Read carefully**

IF YOU ARE EXPERIENCING ANY ISSUES WITH THE PRODUCT DURING OPERATION, DO NOT RETURN THE PRODUCT TO THE STORE. CONTACT TINY TRAVELER™ DIRECTLY FOR INSTRUCTIONS ON HOW TO RETURN/EXCHANGE THE PRODUCT. PLEASE KEEP YOUR ORIGINAL RECEIPT AS PROOF OF PURCHASE MUST BE PROVIDED. FULL WARRANTY INFORMATION IS INCLUDED IN THIS USER MANUAL.

Tiny Traveler™
A Horizon Brands Company
Tel.:866.294.9244

Email us at: info@mytinytraveler.com

TABLE OF CONTENTS

1. Introduction	4
2. Important Safety Information	4
3. Package Contents	6
4. Product Specifications	7
5. Product Overview	7
6. Installation Guide	8
7. Connect to Power	10
8. Pairing the Camera	11
9. Configuration & Menu Setting	12
10. Safety Information	14
11. Maintenance & Warranty	15
12. General Information	18

1. INTRODUCTION

Thank you for purchasing the Tiny Traveler™ Add-On Camera. Designed by our family with your family in mind. Tiny Traveler™ is set out to create simplified tech to keep your Tiny Traveler™ safer. The Tiny Traveler™ Add-On Camera is essential for your growing family. It offers you the capability to view more than one child (perfect if you have twins or a toddler and a newborn) in your rear seats. It's packed with features such as night vision, and the ability to view rear or forward-facing car seats. Whether it's a quick run to the grocery store, driving to the park or road trips, you'll be able to keep eyes on your Tiny Traveler™ wherever you go. Please read all of the installation instructions carefully before installing your Monitor. Improper installation or use will void the manufacturer's warranty. Welcome to the Tiny Traveler™ family!

2. IMPORTANT SAFETY INFORMATION

Thank you for purchasing the Add-On Camera. Tiny Traveler™ is dedicated to safe driving practices and strives to limit distractions for drivers. The Add-On Camera, along with the 5" Car Baby Monitor, is intended to aid in helping drivers traveling with a baby remain focused on driving safely and still have the peace of mind of being able to glance at their baby in the back seat. A driver's main focus should always be on the road and their surroundings. The Add-On Camera allows the driver to monitor the baby's activities without having to turn around and take their eyes off the road. Please read all of the installation instructions carefully before installing your Monitor. Improper installation or use will void the manufacturer's warranty.

- Consult local laws and regulations for any restriction on installation or use and obey all legal requirements for safe vehicle operation, including those related to distracted driving.
- A failure to read and follow these warnings and instructions may result in a serious accident, including damaged property or a serious injury, including loss of life. Please keep this user manual for further reference.
- The Add-On Camera, along with the 5" Car Baby Monitor, is a system that is intended as an aid to monitor your baby while you are driving by allowing for quick glances at your baby while facing forward and without having to turn around and take your eyes off the road. It is not a substitute for responsible and proper adult supervision of children and should not be used as such.

- Make sure that at no time does the Add-On Camera or cables come in any contact or within reach of your baby.
- Check your local laws and regulations about having a Monitor with live video feed while driving. Please take note that the Monitor will show the image taken by the Camera continuously as long as they are connected, the car is running, and the Monitor is powered on.
- This product will only provide images of items that are within the field of view of the Camera. Thus, it is imperative that the Camera should be kept clean and unobstructed. And should be mounted so that its field of view includes the entire area around the car seat.
- Note that the image in the Monitor will be a reversed image of the baby.
- The 5" Car Baby Monitor is made for use indoor or inside your vehicle. It is not meant for outdoor use.
- Do not get any of the Tiny Traveler™ Add-On Camera components wet or exposed to moisture.
- At any time, do not attempt to open the Monitor or Camera, or use different cables other than the ones provided with the original packaging.
- During installation, do not have the baby in the car. The car seat should be correctly mounted in the car as required by law. There is no need to have the baby in the car while the Add-On Camera is installed, and should be kept away as a precaution.
- Before mounting the Camera, check your local laws and regulations regarding where the device is legally allowed to be mounted.
- The Camera should be mounted securely as instructed. At no time should it be loose or not fixed in place with the mounts provided.
- DO NOT attach the Camera to the car seat. DO NOT lay the Camera loosely in the car seat.
- This system is powered by plugging the power cable provided into a 12/24V adapter in your vehicle or USB media ports. Do not attempt to use any other power source or cables to operate this system.
- The Tiny Traveler™ Add-On Camera is not a toy. At no time should children be allowed to play with it. It should only be operated by adults who have read the safety and operating instructions listed in this manual.
- This product contains small parts. Adult installation is required. Exercise care when unpacking and assembling the product.
- Only use the Home Adapter, USB Charger or any attachments as provided or sold separately by the manufacturer.

3. PACKAGE CONTENTS

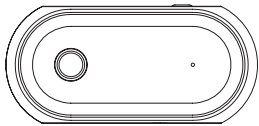

Tiny Traveler™
Add-On Camera

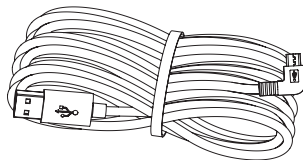

9.8' / 3m
Micro USB Power Cable

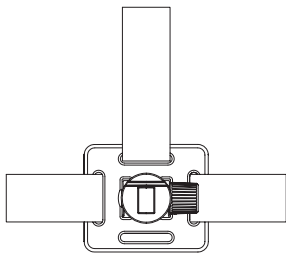

Camera Headrest Mount
with Straps

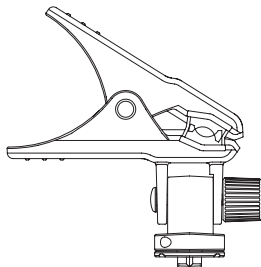

Camera
Spring Loaded Clamp

4. PRODUCT SPECIFICATIONS

Frequency:	2.4 GHz
Camera Resolution:	HD 720P
Camera Viewing Angle:	FOV(H) 79°
Operating Temperature:	14°F ~ 122°F (-10°C ~ 50°C)
Operating Voltage:	DC 5V (Micro USB)
Maximum Signal Range:	33 Feet / 10 Meters (without interference or obstruction)

5. PRODUCT OVERVIEW

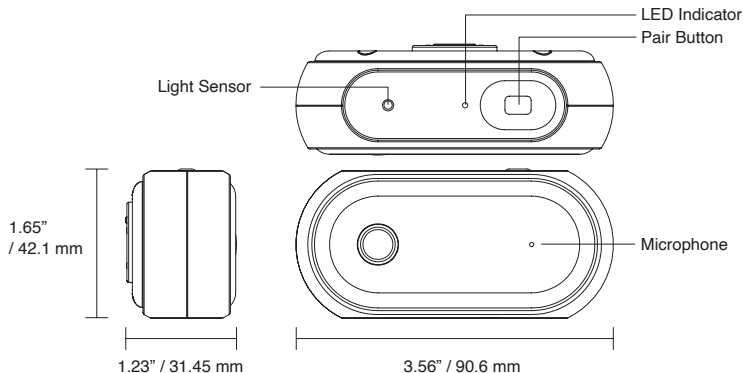

6. INSTALLATION GUIDE

Before selecting which camera mount to use, it is best to determine where in the car the Camera will best be placed in order to capture the image of your baby's car seat. Make sure the Camera is not located near the airbag. If your car seat is rear or forward facing you have several options:

Option 1: Headrest Mount with Straps

Use the Headrest Mount with Straps to attach to the headrest of the front or back seat by pulling the vertical and horizontal straps and securing with the plastic ladder lock buckle. The Camera should be mounted tightly to the headrest so that the Camera is stable. The Camera can then be adjusted to angle accordingly to capture the entire car seat. Adjust the angle of the Camera by loosening the nut and rotate to your desired angle.

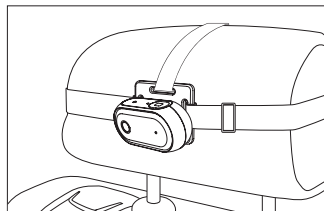
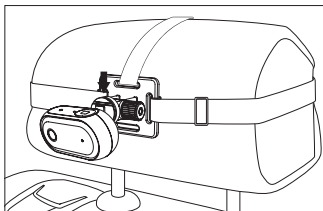
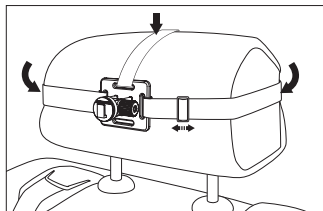

Option 2: Spring Loaded Clamp

To mount the Camera using the Spring Loaded Clamp, place the clamp around the headrest pole that best suits the Camera placement that is needed. Attach the Camera on the bracket of the clamp. Adjust the angle of the Camera by loosening the nut and rotate to your desired angle.

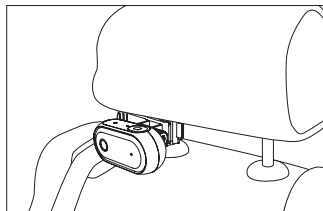
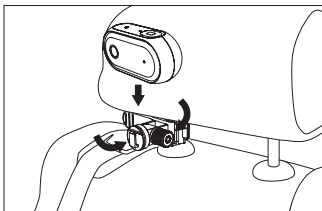
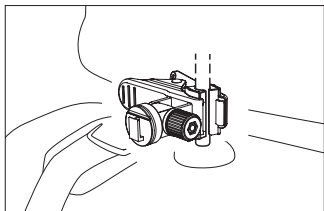

7. CONNECT TO POWER

The Add-On Camera comes with a 9.8' (3m) Micro USB Power Cable which can be plugged into any available USB media port in your vehicle.

Starting with the power cable plugged to the base of the Camera. Ensure that the cable is not in contact with the car seat or within reaching distance of the baby. It is recommended to tuck the cable behind the seat, lining, rug or panels in order to keep it from tangling or getting caught in any object.

Once you have the Camera secure in its mount, and the power cable tucked carefully out of the way, you can plug the power cable into the USB media port.

NOTE: If your vehicle does not have a media port you need to connect the USB power cable to the 12/24V power socket through a USB power adapter (not included in this package).

Usage Precautions

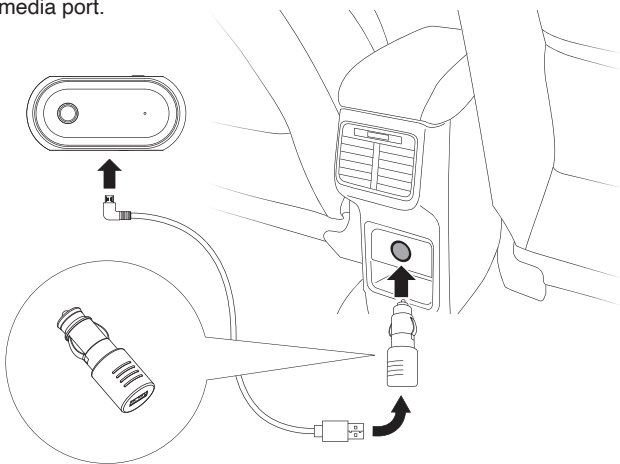

Many vehicles provide constant power to the 12/24V outlet. If your outlet provides constant power, please remember to unplug the LCD Touch Screen Monitor and Camera when not in use to avoid draining of the vehicle's battery.



USB Adapter not included

8. PAIRING THE CAMERA

These simple steps will pair the Add-On Camera to your existing Tiny Traveler™ 5" Car Baby Monitor system:

1. Turn on your vehicle's power to power up the existing Car Baby Monitor system.
2. Power on the Add-On Camera.
3. On the LCD Touch Screen Monitor, tap  **System Setting**.
4. Tap  **Pair Camera**.
5. Choose **Camera 2** and click to pair.

NOTE: **Camera 2** is the designated slot for the Add-On Camera.

6. On the Add-On Camera hold down the pair button for 5 secs until the pair indicator light blinks blue.
7. Pairing is done when you see **Pair OK**.
You should see the image from Camera 2.

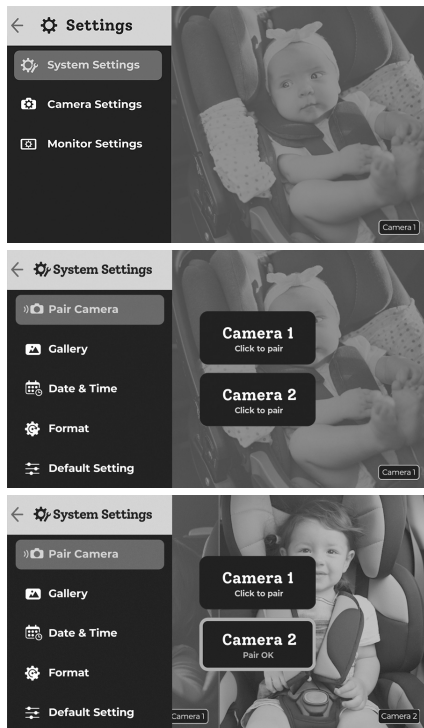

9. CONFIGURATION AND MENU SETTING

The 5" LCD Monitor operates by touch screen; all the functions can be done by tapping and swiping on the screen. Tap on the **i** **Tips** icon for on-screen instructions.

Please refer to the instruction manual of the 5" Car Baby Monitor System for all the menu settings.

Split Screen

You can tap the **1 2** **Split Screen** icon to toggle between different screen modes after you pair the Add-On Camera with the Monitor.

Battery Indicator

The battery indicator shows the battery level of the Touch Screen LCD Monitor.

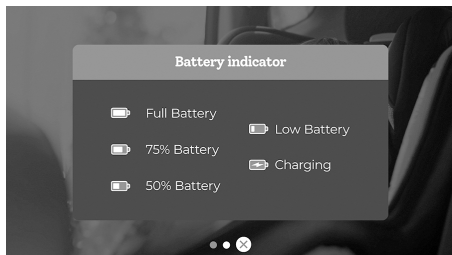
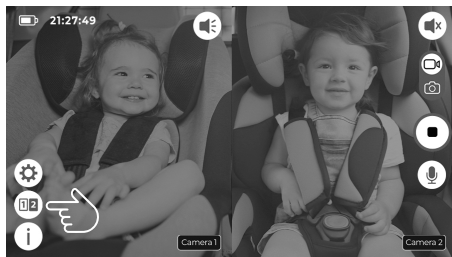
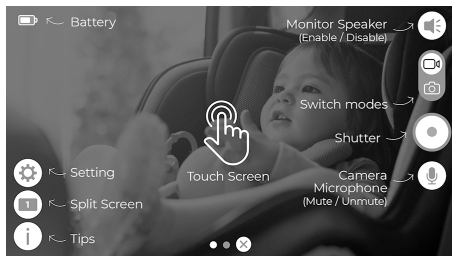

Camera Settings

NOTE: Camera settings are not available in Split Screen Mode. You must switch to Camera 1 or Camera 2 by tapping the Split Screen Mode Icon before configuring any camera settings.

1. Contrast - Swipe the slider to adjust screen contrast.
2. Saturation - Swipe the slider to adjust Car Camera color saturation.
3. Rotate Camera - Rotate the screen orientation if your mounting angle requires you to flip the Car Camera.
4. Voice Activation - Swipe the slider to adjust to your desired level of voice sensitivity. The higher the sensitivity the Car Camera will more likely detect sound in the surroundings and wake up the screen from screen save mode. Voice activation can also be turned off.
5. Night Vision - Swipe the slider to adjust night vision exposure level or to disable night vision.

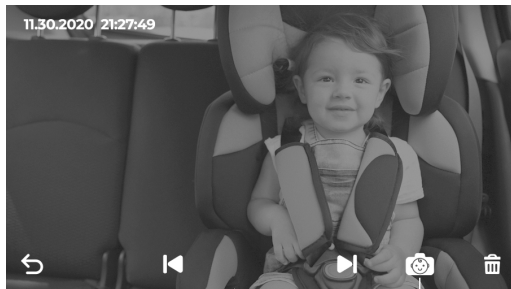

Tap this icon to set the photo as the background image of the warning notification. Tap the icon on the same photo again to switch back to the default photo.

Monitor Settings

1. Loop Record - Select the duration of each recorded footage.
2. Warning Image - Turn the Warning Notification On/Off. Tap the  **Warning Notification** icon on a pre-recorded photo to set it as the background image of the warning notification.
3. Screen Save - Monitor screen will be turned off after a chosen period of time. Alternatively, press the Monitor power button once to enter screen save mode. You can wake up the Monitor by tapping on the screen or voice activation.
4. Monitor Brightness - Swipe the slider to adjust brightness of the Monitor.
5. Language - Set your preferred language.

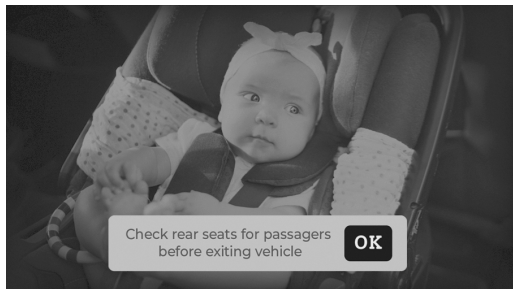

Warning Notification

10. SAFETY INFORMATION

IMPORTANT SAFETY INSTRUCTIONS

1. **SAVE THESE INSTRUCTIONS** – This manual contains important safety and operating instructions for USB Adapter Model CHR05-01-USB (Sold separately with Camera Kit)
2. Before using USB Adapter, read all instructions and cautionary markings on Camera and Monitor.
3. Do not expose charger to rain, moisture, or snow.
4. Use of an attachment not recommended or sold by the manufacturer may result in a risk of fire, electric shock, or injury to persons.
5. To reduce risk of damage to cigarette lighter connector and cord, pull by cigarette lighter connector rather than cord when disconnecting charger.

6. Make sure cord is located so that it will not be stepped on, tripped over, or otherwise subjected to damage or stress.
7. Do not operate charger with damaged cord or cigarette lighter connector – replace it immediately.
8. Do not operate charger if it has received a sharp blow, been dropped, or otherwise damaged in any way; take it to a qualified serviceperson.
9. Do not disassemble charger; take it to a qualified serviceperson when service or repair is required. Incorrect reassembly may result in a risk of electric shock or fire.
10. To reduce risk of electric shock, unplug charger before attempting any maintenance or cleaning. Turning off controls will not reduce this risk.
11. Make sure cord is located so it will not be stepped on, tripped over, or otherwise subjected to damage or stress.

WARNING: A failure to read and follow these warnings and instructions may result in a serious accident, including damaged property or a serious injury, including loss of life.

11. MAINTENANCE & WARRANTY

Tiny Traveler™ Limited Warranty

Tiny Traveler™ warrants, to the original purchaser, that its products are free from defects in material and workmanship for 1 year from the date of original purchase. Where permitted by law, Tiny Traveler's liability shall be limited to that set forth in this limited express warranty. This limited express warranty shall be the exclusive remedy of the purchaser and Tiny Traveler™ makes no other warranty of any kind aside from the limited express warranty stated above.

NOTE: Warranty only applies for North American customers of purchases made in North America. Register your Tiny Traveler™ products at www.mytinytraveler.com within 30 days of purchase to redeem your 1 year warranty.

Conditions of Warranty

If during the 1 year warranty period your new product is found to be defective, Tiny Traveler™ will repair such defect, or replace the product, without charge for parts or labor subject to the following conditions:

- All repairs must be performed by Tiny Traveler™.
- All warranty claims must be accompanied by a copy of the sales receipt or bill of sale.
- The equipment must not have been altered or damaged through negligence, accident, improper operation, or failure to follow the product instructions for installation, use, or care.
- The replacement of parts is excluded from the warranty when replacement is necessary due to normal wear and tear.
- Repair or replacement parts supplied by Tiny Traveler™ under this warranty are protected only for the unexpired portion of the original warranty.
- This is a “repair or replace” warranty only, and does not cover the costs incurred for the installation, removal or reinstallation of the product, or damage to any device or vehicle.

Owner’s responsibilities:

Tiny Traveler™ will make every effort to provide warranty service within a reasonable period of time. SHOULD YOU HAVE ANY QUESTIONS ABOUT SERVICE RECEIVED OR IF YOU WOULD LIKE ASSISTANCE IN OBTAINING SERVICE, PLEASE CALL TOLL FREE 1.866.294.9244 DURING REGULAR BUSINESS HOURS MONDAY THROUGH FRIDAY 8:00 AM TO 5:00PM.

NOTE: Toll Free # is for North America Customers ONLY.

If at that time it is determined that a replacement unit is needed, the support representative will issue a Return Authorization and instruct on how to get a new unit. Tiny Traveler™ makes no other warranty of any kind aside from the limited express warranty stated herein.

DISCLAIMER OF WARRANTIES, INCLUDING WARRANTY OF MERCHANTABILITY AND WARRANTY OF FITNESS FOR PARTICULAR PURPOSE: EXCEPT AS SPECIFICALLY SET FORTH HEREIN, NO WARRANTY OR REPRESENTATION, EXPRESS OR IMPLIED, IS MADE AS TO THE ADD-ON CAMERA. EXCEPT AS EXPRESSLY SET FORTH HEREIN, TINY TRAVELER™ AND/OR ITS AFFILIATES EXPRESSLY DISCLAIMS, WITHOUT LIMITATION, ANY STATUTORY WARRANTIES AND ALL IMPLIED WARRANTIES, INCLUDING ANY IMPLIED WARRANTY OF MERCHANTABILITY OR FITNESS FOR A PARTICULAR PURPOSE.

Tiny Traveler™ and/or its affiliates do not guarantee or promise that the user of the Add-On Camera will not be in an accident or otherwise not collide with an object and/or person. Our Add-On Camera is not intended in any way to be a substitute for careful and cautious driving or for the consistent adherence to all applicable traffic laws and motor vehicle safety regulations.

Tiny Traveler™ and/or its affiliates are not responsible for a user's intended or actual use of the Add-On Camera. In no event shall Tiny Traveler™ and/or its affiliates have any liability for any losses (whether direct or indirect, in contract, tort or otherwise) incurred in connection with the Add-On Camera, including but not limited to damaged property, personal injury and/or loss of life. Neither shall Tiny Traveler™ and/or its affiliates have any liability for any decision, action or inaction taken by any person in reliance on the Add-On Camera, or for any delays, inaccuracies and /or errors in connection with the Add-On Camera and its functioning.

Tiny Traveler™ and/or its affiliates shall have no responsibility or liability for damage and/or injury resulting from accidents occurring with vehicles having the installed, and Tiny Traveler™ and/or its affiliates, the manufacturer, distributor and seller shall not be liable for any injury, loss or damage, incidental or consequential, arising out of the use or intended use of the product.

12. GENERAL INFORMATION

Customer Service/Contact

IF YOU ARE EXPERIENCING ANY ISSUES WITH THE PRODUCT DURING OPERATION, DO NOT RETURN THE PRODUCT TO THE STORE. CONTACT TINY TRAVELER™ DIRECTLY FOR INSTRUCTIONS ON HOW TO RETURN / EXCHANGE THE PRODUCT.

FCC Compliance Statement:

This device complies with Part 15 of the FCC rules. Operation is subject to the following two conditions: (1) This device may not cause harmful interference, and (2) this device must accept any interference received, including interference that may cause undesired operation.

WARNING: Changes or modifications to this unit not expressly approved by the party responsible for compliance could void the user's authority to operate the equipment. The manufacturer is not responsible for any radio or TV interference caused by unauthorized modifications or change to this equipment. Such modifications or change could void the user's authority to operate the equipment.

NOTE: This equipment has been tested and found to comply with the limits for Class B digital device, pursuant to part 15 of the FCC Rules. These limits are designed to provide reasonable protection against harmful interference in a residential installation. This equipment generates, uses and can radiate radio frequency energy and, if not installed and used in accordance with the instructions, may cause harmful interference to radio or television reception, which can be determined by turning the equipment off and on, the user is encouraged to try to correct the interference by one or more of the following measures:

- Reorient or relocate the receiving antenna.
- Increase the separation between the equipment and the receiver.
- Connect the equipment into an outlet on a circuit different from that to which the receiver is connected.
- Consult the dealer or an experienced radio/TV technician for help.

The device has been evaluated to meet general RF exposure requirement. To maintain compliance with FCC/IC's RF exposure guidelines, this equipment should be installed and operated with a minimum distance of 20cm between the radiator and your body.

Strangulation Hazard:

Children have STRANGLED in cords. Keep the unit and cord more than 3 feet from the crib or car seat and out of baby's reach. NEVER place Camera or cords within the crib or car seat. Secure the cord more than 3 feet away from the baby's reach.

Tiny Traveler™ Add-On Camera
Perfect For Your Growing Family!
TT002

Responsible Party:

Tiny Traveler™
2975 Red Hill Ave., Ste. 100, Costa Mesa, CA 92626
Tel: 866-294-9244



A Horizon Brands Company
2975 Red Hill Ave., Ste. 100,
Costa Mesa, CA 92626
1.866.294.9244

info@mytinytraveler.com
© 2021 ADC Solutions Auto, LLC.

All rights reserved.

www.mytinytraveler.com



@mytinytraveler

ML-532472_V1