

Model:

SPP-70-9

Pizza Prep Table:

Solid Door Refrigerator



SPP-70-9

- **Stainless steel interior and exterior** retains attractive finish longer. Matching aluminium finished back
- **Rounded corner** design inside of the cabinet makes it easy to clean the inside storage room
- **Standard door features:**
Positive seal self-closing door(s) with 90° stay open feature.
Magnetic door gasket(s) removable without tools for easy of cleaning
- **R290 Refrigeration system** holds 33°F to 41°F (0.5°C to 5°C) for the best in food preservation.
- **Electronic control system:**
Adjustable temperature set point and defrost frequency
Error codes to diagnose service issues
- **Shelf:** Adjustable, heavy duty PVC coated shelves.
- **Standard heavy-duty casters** make it easy to move and clean underneath
- **Condensing unit** access in front of cabinet, slides out for easy maintenance
- **Insulated lid** on prep units helps maintain food freshness.

Rough-In Data

Specifications subject to change without notice.

Chart dimensions rounded up to the nearest 1/8" (millimeters rounded up to next whole number).

Model	Doors	Shelves	Cabinet Dimensions (inches) (mm)			CAP. CU.FT. LITER	HP	Voltage	Amps	NEMA Config.
			L	D	H					
SPP-70-9	2	2	70-7/8 1800	31-1/2 800	39-3/8 998	16.9 477	1/3+	115/60/1	5.9	5-15P 

Plug type varies by country.



SABA

Add: 3390 Enterprise Avenue, Hayward, CA 94545

Tel: (510) 293-0189 Fax: (510) 293-0199 E-mail: info@sabacorpusa.com Website: www.sabacorpusa.com

SPP-70-9 Plan View

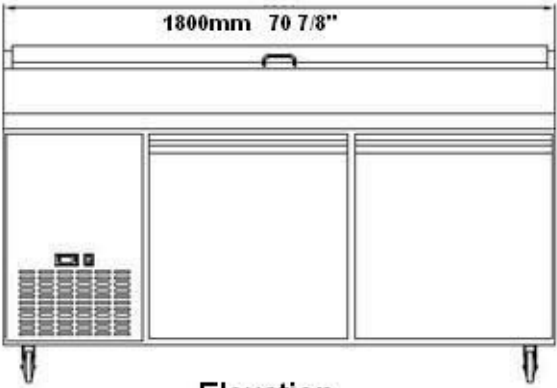

Elevation

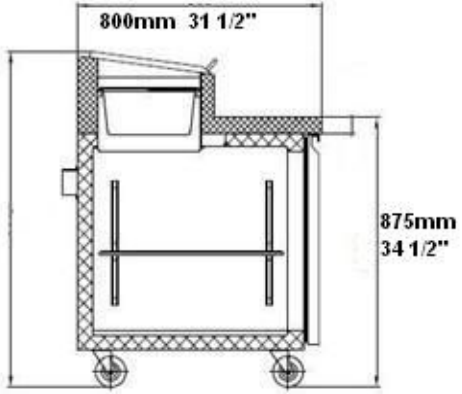

Section View

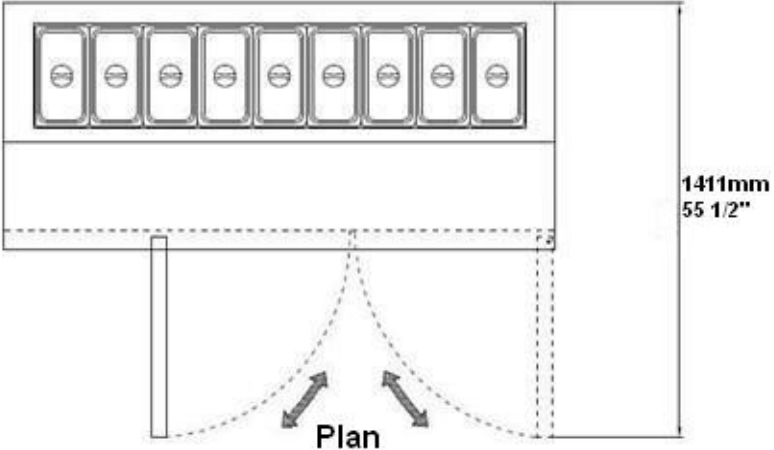

Plan

PAN LAYOUTS

9 (pcs) 1/3 pans

