

MADE IN DENMARK



EDGE BY HAMMEL

Vejl. prislister DKK inkl. moms



Ret til ændringer forbeholdes
2021/2

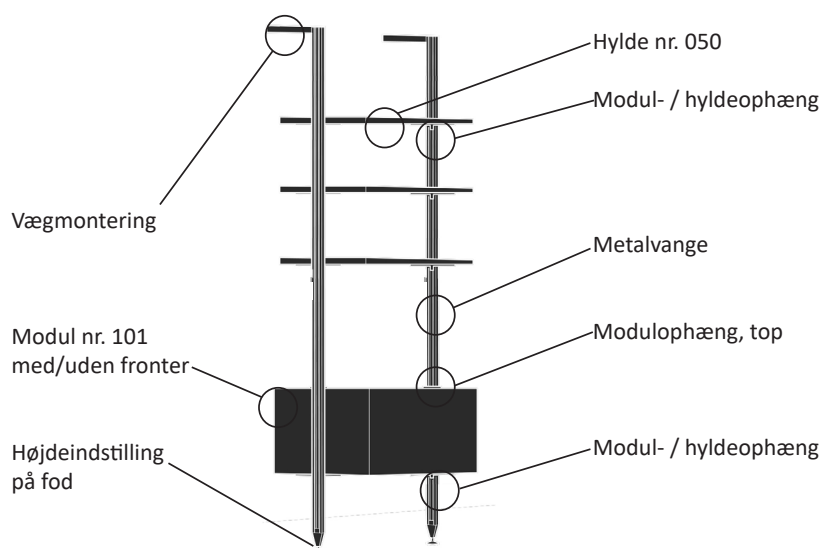

hammel[®]

Modul	Vangereol		Mål i cm BxHxD	Sort	Hvid
400		Vangereol basismodul. Leveres inkl.: 2 metalvanger, murmontering, beslag til brug for 4 hylde eller til 3 hylde og 1 skab. Højdejusterbar. Tilbehør se side 3.	2,5x210x22 Kg/m ³ 5,3/0,013	40 08 0400 2434	40 07 0400 2434
401		Vangereol tilbygningsmodul. Leveres inkl.: 1 metalvange, murmontering, beslag til brug for 4 hylde eller til 3 hylde og 1 skab. Højdejusterbar. Tilbehør se side 3.	2,5x210x22 Kg/m ³ 3,3/0,009	40 08 0401 1690	40 07 0401 1690



Modul	Vangereol		Mål i cm BxHxD	Sort	Hvid
420		Til ekstra modul- / hyldeophæng. Pulverlakeret i sort eller hvid.	1,6x4,5x25 Kg/m ³ 0,2/0,001	40 08 0420 149	40 07 0420 149
421		Til ekstra modulophæng, top. Til ét ekstra skab skal der bruges 1x420 og 1x421. Pulverlakeret i sort eller hvid.	2X4X5,3 Kg/m ³ 0,2/0,001	40 08 0421 122	40 07 0421 122
422		Bøjlestang inkl. 2 afstandsstykker. Total dybde 30cm. Med gummikant for oven. Pulverlakeret i sort eller hvid.	90X3,5X1,15 Kg/m ³ 0,6/0,001	40 08 0422 676	40 07 0422 676



1x400*4x050



1x400*1x401*3x050*4x051
+1x101*1x012*2x011



1x400*1x401*7x050*1x101
+2x012



1x400*2x401*10x050*2x101*2x012*4x011













EDGE BY HAMMEL

Max kg = max anbefalet totalvægt for indhold i og ovenpå væghængt modul.

Vejl. prisliste DKK

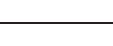
Varenr. struktur:
EKS: skab nr. 100 i sort:
40 72 0100

Pris gr. 1 (xx)	Pris gr. 2 (xx)	Pris gr. 3 (xx)
81 snehvid	Grundmoduler + hylder: 16 røget eg 75 sort bejdsset Fronter: 15 hvidpig. eg* 16 røget eg 75 sort bejdsset *mat lak	72 sort 82 antracit 95 grafit 98 cappuccino

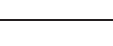
Modul	Moduler til vangereol		Mål i cm BxHxD	Prisgr.1	Prisgr.2	Prisgr.3	
050		5 MAX kg	Hylde til vangereol til 1 sektion. Ved mere end 4 hylder, husk at tilkøbe beslag nr. 420.	90,8x1,9x32,5 Kg/m ³ 5/0,009	40 xx 0050 622	40 xx 0050 811	40 xx 0050 744
051		5 MAX kg	Hylde til vangereol til 1/2 sektion. Ved mere end 4 hylder, husk at tilkøbe beslag nr. 420.	46x1,9x32,5 Kg/m ³ 2,4/0,005	40 xx 0051 352	40 xx 0051 433	40 xx 0051 460
211		20 MAX kg	Skrivepult. Inkl. metalstang, skillerum, hylde, skriveunderlag. Med kabelhul i bunden. Skuffe under klappen.	90,8x46,2x32,5 Kg/m ³ 31/0,213	40 xx 0211 5814	40 xx 0211 6746 Fås i farve 16+75	40 xx 0211 6882
101		40 MAX kg	Skab, åben. Til montering i vangereol.	90,8x46,2x32,5 Kg/m ³ 18,7/0,213	40 xx 0101 2028	40 xx 0101 2434	40 xx 0101 2488
100		20 MAX kg	Skab, åben. Til montering i vangereol.	46,2x46,2x32,5 Kg/m ³ 10,8/0,116	40 xx 0100 1758	40 xx 0100 2028	40 xx 0100 2096
102		20 MAX kg	Skab inkl. 1 hylde, åben. Til montering i vangereol.	46,2x90,8x32,5 Kg/m ³ 18,2/0,215	40 xx 0102 2028	40 xx 0102 2434	40 xx 0102 2488
010		5 MAX kg	Hylde til modul 100 + 101 + 102.	42,3x1,7x28,1 Kg/m ³ 1,5/0,004	40 xx 0010 270	40 xx 0010 324	40 xx 0010 338
011		10 MAX kg	Skuffe til modul 100 + 101 + 102. Med pushåbning og fuldt udtræk.	44,4x22x26,7 Kg/m ³ 4,5/0,038	40 xx 0011 1338	40 xx 0011 1406	40 xx 0011 1420
012			Dør til modul 100 + 101 + 102. Med pushåbning.	44,4x44,4x1,7 Kg/m ³ 2,8/0,011	40 xx 0012 608	40 xx 0012 879	40 xx 0012 946
013			Høj dør til 102. Med pushåbning.	44,4x89,2x1,7 Kg/m ³ 5,2/0,022	40 xx 0013 811	40 xx 0013 1014	40 xx 0013 1068
021			Lav klap til 101. Med pushåbning.	89,2x22x1,7 Kg/m ³ 3/0,013	40 xx 0021 1217	40 xx 0021 1487	40 xx 0021 1555
014			Høj klap til 101. Med pushåbning.	89,2x44,4x1,7 Kg/m ³ 5,6/0,022	40 xx 0014 1487	40 xx 0014 1758	40 xx 0014 1825
022 023 035			Lav stofklap til 101. Med pushåbning.	89,2x22x1,7 Kg/m ³ 2,1/0,013	40 05 0022 1758 sort	40 05 0023 2096 grafit	40 05 0035 2096 hvid
015 016 036			Høj stofklap til 101. Med pushåbning.	89,2x44,4x1,7 Kg/m ³ 3,1/0,022	40 05 0015 1893 sort	40 05 0016 2501 grafit	40 05 0036 2501 hvid

















EDGE BY HAMMEL

Max kg = max anbefalet totalvægt
for indhold i og ovenpå væghængt modul.

Vejl. prisliste DKK

Varenr. struktur:
EKS: skab nr. 100 i sort:
40 72 0100

Pris gr. 1 (xx)	Pris gr. 2 (xx)	Pris gr. 3 (xx)
81 snehvid	Grundmoduler + hylder: 16 røget eg 75 sort bejdset Fronter: 15 hvidpig. eg* 16 røget eg 75 sort bejdset *mat lak	72 sort 82 antracit 95 grafit 98 cappuccino

Modul	Grundmoduler D: 32,5 cm	Mål i cm BxHxD	Prisgr.1	Prisgr.2	Prisgr.3
100	 20 MAX kg Skab, åben. Ved ben: anvend min. 4 stk.	46,2x46,2x32,5 Kg/m ³ 10,8/0,116	40 xx 0100 1758	40 xx 0100 2028	40 xx 0100 2096
101	 40 MAX kg Skab, åben. Ved ben: anvend min. 4 stk.	90,8x46,2x32,5 Kg/m ³ 18,7/0,213	40 xx 0101 2028	40 xx 0101 2434	40 xx 0101 2488
211	 20 MAX kg Skrivepult. Inkl. metalstang, skillerum, hylde, skriveunderlag. Med kabelhul i bunden. Skuffe under klappen.	90,8x46,2x32,5 Kg/m ³ 31/0,213	40 xx 0211 5814	40 xx 0211 6746 Fås i farve 16+75	40 xx 0211 6882
102	 20 MAX kg Skab inkl. 1 hylde, åben. Ved ben: anvend min. 4 stk.	46,2x90,8x32,5 Kg/m ³ 18,2/0,215	40 xx 0102 2028	40 xx 0102 2434	40 xx 0102 2488
103	 40 MAX kg Skab inkl. 2 hylder, åben. Ved ben: anvend min. 4 stk.	90,8x90,8x32,5 Kg/m ³ 30/0,394	40 xx 0103 2434	40 xx 0103 3110	40 xx 0103 3177
052	 Bagklædning til skab 103. Inkl. monteringsbeslag. Så modulet kan anvendes fritstående.	90,3x90,3x1,2 Kg/m ³ 8/0,024	40 xx 0052 1163		40 xx 0052 1284
Modul	Tilbehør til D: 32,5	Mål i cm BxHxD	Prisgr.1	Prisgr.2	Prisgr.3
010	 5 MAX kg Hylde til modul 100 + 101 + 102 + 103.	42,3x1,7x28,1 Kg/m ³ 1,5/0,004	40 xx 0010 270	40 xx 0010 324	40 xx 0010 338
011	 10 MAX kg Skuffe til modul 100 + 101 + 102 + 103. Med pushåbning og fuldt udtræk.	44,4x22x26,7 Kg/m ³ 4,5/0,038	40 xx 0011 1338	40 xx 0011 1406	40 xx 0011 1420
012	 Dør til modul 100 + 101 + 102 + 103. Med pushåbning.	44,4x44,4x1,7 Kg/m ³ 2,8/0,011	40 xx 0012 608	40 xx 0012 879	40 xx 0012 946
013	 Høj dør til 102 + 103. Med pushåbning.	44,4x89,2x1,7 Kg/m ³ 5,2/0,022	40 xx 0013 811	40 xx 0013 1014	40 xx 0013 1068
021	 Lav klap til 101 + 103. Med pushåbning.	89,2x22x1,7 Kg/m ³ 3/0,013	40 xx 0021 1217	40 xx 0021 1487	40 xx 0021 1555
014	 Høj klap til 101 + 103 Med pushåbning. 103: For montering i bund, monteres push-beslag i siden af modulet.	89,2x44,4x1,7 Kg/m ³ 5,6/0,022	40 xx 0014 1487	40 xx 0014 1758	40 xx 0014 1825
022 023 035	 Lav stofklap til 101 + 103. Med pushåbning.	89,2x22x1,7 Kg/m ³ 2,1/0,013	40 05 0022 1758 sort	40 05 0023 2096 grafit	40 05 0035 2096 hvid
015 016 036	 Høj stofklap til 101 + 103. Med pushåbning. 103: For montage i bund, monteres push-beslag i siden af modulet.	89,2x44,4x1,7 Kg/m ³ 3,1/0,022	40 05 0015 1893 sort	40 05 0016 2501 grafit	40 05 0036 2501 hvid
Modul	Grundmoduler alm. Samling D: 32,5 cm	Mål i cm BxHxD	Prisgr.1	Prisgr.2	Prisgr.3
300	 20 MAX kg Åben reol inkl. 2 hylder. Ved ben: anvend min. 4 stk. NB: ben 174+176 kan IKKE anvendes. Der findes ingen fronter til modul 300.	23,8x127,2x32,5 Kg/m ³ 12,1/0,165	40 xx 0300 2163	40 xx 0300 2636	40 xx 0300 2704











EDGE BY HAMMEL

Max kg = max anbefalet totalvægt
for indhold i og ovenpå væghængt modul.

Vejl. prisliste DKK

Pris gr. 1 (xx)	Pris gr. 2 (xx)	Pris gr. 3 (xx)
81 snehvid	Grundmoduler + hylder: 16 røget eg 75 sort bejdet Fronter: 15 hvidpig. eg* 16 røget eg 75 sort bejdet *mat lak	72 sort 82 antracit 95 grafit 98 cappuccino

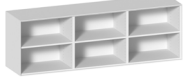
Varenr. struktur:
EKS: skab nr. 100 i sort:
40 72 0100

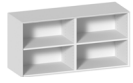
Modul	Grundmoduler D: 42 cm		Mål i cm BxHxD	Prisgr.1	Prisgr.2	Prisgr.3
104		40 MAX kg	Skab, inkl. 2 hylder, åben. Inkl. dæksel. Ved ben: anvend min. 4 stk. Kg/m ³ 38/0,492	90,8x90,8x42 2974	40 xx 0104 3515	40 xx 0104 3650
052			Bagklædning til skab 104. Inkl. monteringsbeslag. Så skabet kan anvendes fritstående. Kg/m ³ 8/0,024	90x,3x90,3x1,2 1163		40 xx 0052 1284
207		20 MAX kg	AV modul, åben. Ledningshul i top og bund. Inkl. dæksel. Væghænges gennem bagklædning. Ved ben: anvend min. 5 stk. Kg/m ³ 18/0,152	90,8x24x42 2434	40 xx 0207 2758	40 xx 0207 2866
208		20 MAX kg	AV modul, åben. Ledningshul i top og bund. Inkl. dæksel. Ved ben: anvend min. 5 stk. Kg/m ³ 21/0,261	90,8x46,2x42 2488	40 xx 0208 2839	40 xx 0208 2907
203		20 MAX kg	Skab, åben. Ved ben: anvend min. 5 stk. Kg/m ³ 45,7/0,502	180,4x46,2x42 3786	40 xx 0203 4597	40 xx 0203 4664
204		20 MAX kg	AV modul, åben. Ledningshul i top og bund. Inkl. dæksel. Ved ben: anvend min. 5 stk. Kg/m ³ 45,7/0,502	180,4x46,2x42 4056	40 xx 0204 4867	40 xx 0204 4935
205		20 MAX kg	Skab, åben. Væghænges gennem bagklædning. Ved ben: anvend min. 4 stk. Kg/m ³ 32,9/0,292	180,4x24x42 3515	40 xx 0205 4326	40 xx 0205 4394
206		20 MAX kg	AV modul, åben. Ledningshul i top og bund. Inkl. dæksel. Væghænges gennem bagklædning. Ved ben: anvend min. 4 stk. Kg/m ³ 32,9/0,292	180,4x24x42 3786	40 xx 0206 4597	40 xx 0206 4664
212		100 MAX kg	AV modul, åben. Ledningshul i top og bund. Inkl. dæksel. NB! Kan IKKE væghænges. Anvend min. 6 ben eller sokkel. Kg/m ³ 48/0,626	225,8x46,2x42 4873	40 xx 0212	40 xx 0212 6003
500		40 MAX kg	Skab inkl. 3 hylder, åben. Ved ben: anvend min. 6 stk. Kg/m ³ 51,8/0,535	179,9x59x42 4326	40 xx 0500 5408	40 xx 0500 5476
053			Bagklædning til skab 500. Inkl. monteringsbeslag. Så skabet kan anvendes fritstående. Kg/m ³ 11/0,03	179,2x58,3x1,2 1298		40 xx 0053 1420
501		20 MAX kg	Skab inkl. 2 hylder, åben. Ved ben: anvend min. 5 stk. Kg/m ³ 31,8/0,428	120,4x59x42 3583	40 xx 0501 4664	40 xx 0501 4732

hammel tegneprogram

Prøv tegneprogrammet fra Hammel. Her kan du nemt designe
din egen opstilling på tablet, mobil eller computer.

Find link til tegneprogrammet på:
www.hammel-furniture.dk/tegneprogram.aspx
Eller download vores app: Hammel

























Max kg = max anbefalet totalvægt
for indhold i og ovenpå væghængt modul.

Vejl. prisliste DKK

Varenr. struktur:
EKS: skab nr. 100 i sort:
40 72 0100

Pris gr. 1 (xx)	Pris gr. 2 (xx)	Pris gr. 3 (xx)
81 snehvid	Grundmoduler + hylder: 16 røget eg 75 sort bejdset Fronter: 15 hvidpig. eg* 16 røget eg 75 sort bejdset *mat lak	72 sort 82 antracit 95 grafit 98 cappuccino

Modul	Tilbehør til D: 42		Mål i cm BxHxD	Prisgr.1	Prisgr.2	Prisgr.3
033		5 MAX kg	Hylde til modul 104 + 212. 42,3x1,7x37,7	40 xx 0033 297	40 xx 0033 352	40 xx 0033 379
019		5 MAX kg	Hylde til modul 203 + 204 + 205 + 206 + 207 + 208 + 212. 87,1x1,7x37,7	40 xx 0019 541	40 xx 0019 622	40 xx 0019 635
031		5 MAX kg	Hylde til modul 500 + 501. 57x1,7x37,7	40 xx 0031 541	40 xx 0031 622	40 xx 0031 635
032		10 MAX kg	Skuffe til modul 104 + 212. Med pushåbning og med fuldt udtræk. 44,4x22x36,7	40 xx 0032 1406	40 xx 0032 1474	40 xx 0032 1501
020		10 MAX kg	Skuffe til modul 203 + 204 + 205 + 206 + 207 + 208 + 209 + 212. Med pushåbning og med fuldt udtræk. 89,2x22x36,7	40 xx 0020 1487	40 xx 0020 1609	40 xx 0020 1622
024		10 MAX kg	Skuffe til modul 500 + 501. Med pushåbning og med fuldt udtræk. 59,1x18,8x36,7	40 xx 0024 1338	40 xx 0024 1406	40 xx 0024 1420
012			Dør til modul 104 + 212. Med pushåbning. 44,4x44,4x1,7	40 xx 0012 608	40 xx 0012 879	40 xx 0012 946
013			Høj dør til 104. Med pushåbning. 44,4x89,2x1,7	40 xx 0013 811	40 xx 0013 1014	40 xx 0013 1068
025			Dør til 500 + 501. Med pushåbning. 59,1x57,1x1,7	40 xx 0025 811	40 xx 0025 1014	40 xx 0025 1068
026 027 037			Stof dør til 500 + 501. Med pushåbning. 59,1x57,1x1,7	40 05 0026 1311 sort	40 05 0027 1717 grafit	40 05 0037 1717 hvid
021			Lav klap til 104 + 203 + 204 + 205 + 206 + 207 + 208 + 212. Med pushåbning. 89,2x22x1,7	40 xx 0021 1217	40 xx 0021 1487	40 xx 0021 1555
014			Høj klap til 104 + 203 + 204 + 208 + 212. Med pushåbning. 89,2x44,4x1,7	40 xx 0014 1487	40 xx 0014 1758	40 xx 0014 1825
022 023 035			Lav stofklap til modul 104+203+204 + 205+206+207+208+212. Med pushåbning. 89,2x22x1,7	40 05 0022 1758 sort	40 05 0023 2096 grafit	40 05 0035 2096 hvid
015 016 036			Høj stofklap til 104 + 203 + 204 + 208+212. Med pushåbning. 89,2x44,4x1,7	40 05 0015 1893 sort	40 05 0016 2501 grafit	40 05 0036 2501 hvid

Modul Hjul og ben		Mål i cm			
177		Stillefødder, 6 stk. Kan monteres under alle grundmoduler.	BxH 2,8x3 Kg/m ³ 1/0,002	10 20 0177	250
187		Rustik hjul, 6 stk. heraf 2 stk. med bremses. Kan monteres under alle grundmoduler.	H 12,5 Kg/m ³ 1,8/0,003	10 20 0187	773
174 176		Metalben, 4 stk. Kan monteres under alle grundmoduler. Husk støtteben 198/199 ved moduler med en bredde på mere end 91 cm.	BxHxØ 22x20x2 Kg/m ³ 2,1/0,011	10 20 0174	10 20 0176 887 sort 887 hvid
198 199		Støtteben, 1 stk. Til brug ved moduler over 91 cm. Kan justeres fra 14- 20 cm.	HxØ 14-20x2 Kg/m ³ 0,4/0,009	10 20 0198	10 20 0199 148 sort 148 hvid
256		Metal sokkel til skab nr. 104. Fås i hvid og sort pulverlak.	BxHxØ 86x30x38,5 Kg/m ³ 5/0,025	40 08 0256	40 07 0256 713 sort 713 hvid
257		Metal sokkel til skab nr. 500+205+206+203+204. Fås i hvid og sort pulverlak.	BxHxØ 176x30x38,5 Kg/m ³ 8/0,050	40 08 0257	40 07 0257 951 sort 951 hvid
Modul Væghylde		Mål i cm BxHxD			
450 452	 5 MAX kg	Metal hylde. Pulverlakeret i sort eller hvid.	65x18,9x27 Kg/m ³ 2,7/0,007	10 20 0450	10 20 0452 744 sort 744 hvid
451 453	 5 MAX kg	Metal hylde. Pulverlakeret i sort eller hvid.	65x18,9x17 Kg/m ³ 2/0,007	10 20 0451	10 20 0453 690 sort 690 hvid

Få yderligere information i vores EDGE by Hammel brochure.
Her finder du inspiration til spændende EDGE by Hammel løsninger.

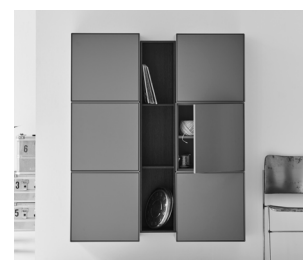
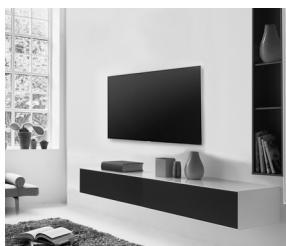

Se disse og flere opstillinger i vores tegneprogram under  Galleri.



hammel®

www.hammel-furniture.dk - facebook.com/byhammel - [instagram @byhammel](https://instagram.com/byhammel) - sales@hammel-furniture.dk