



Dishwasher

Instruction Manual

**Model Code: MDWF1SS
MDWF1W**

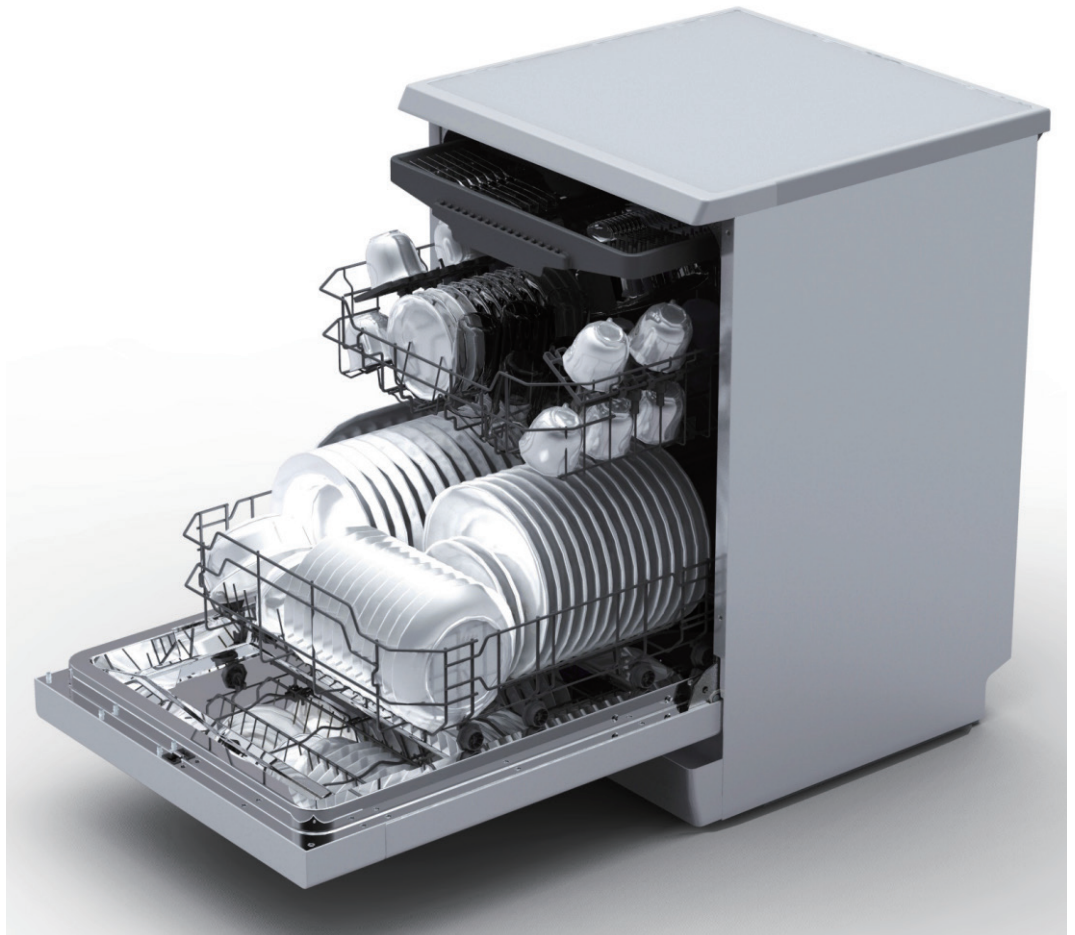

- 14place settings
- 8 Wash Programs
- Push Button Controls

Service Call: 1800 886 010



Quick Operation Guide

For detailed operating guide, read corresponding contents in the Instruction Manual.

Switch on the appliance	Open the door, press the On/Off button to switch on the appliance.
Use tablet or liquid fill the detergent dispenser	<p>Compartment A: For each washing cycle.</p> <p>Compartment B: For programs with pre-wash only. (Follow the user instructions)</p>
Check the rinse aid level	<p>Mechanical indicator C. Electric indicator on control panel (if provided).</p>
Load the baskets	Scrape off any large food particles. Soften remnants of burnt food in pans, after then load the baskets. Refer to the dishwasher loading instructions.
Select a program	Close the door, press the Program button until the selected program lights up. (See the section entitled Operation Instruction)
Start the dishwasher	Turn the water tap and press the Start/Pause button . The machine will start working after about 10 seconds.
	
<ul style="list-style-type: none"> • Change the program 	<ul style="list-style-type: none"> • 1. A running cycle can only be modified if it has been running for a short time. Otherwise the detergent may have already been released and the water already drained. If in this case, the detergent dispenser must be refilled. • 2. Press the Start/Pause button, the machine will be in standby state. Press the program button for more than 3 seconds, then you can change the program to the desired cycle setting. • 3. Press the Start/Pause button, then the dishwasher will run after 10 seconds.
<ul style="list-style-type: none"> • Add forgotten dishes into the dishwasher. 	<ul style="list-style-type: none"> • 1. Press the Start/Pause button to stop the washing. • 2. Open the door a little. • 3. After the spray arms stop working, you can open the door completely. • 4. Add forgotten dishes. • 5. Close the door. • 6. Press the Start/Pause button, then the dishwasher will run after 10 seconds.
<ul style="list-style-type: none"> • If the appliance is switched off during a washing cycle. 	<ul style="list-style-type: none"> • If the appliance is switched off during a washing cycle, when switched on again, please reselect the washing cycle and operate the dishwasher according to the original power-on state).
	
Switch off the appliance	When the working cycle is finished, the buzzer of the dishwasher will sound 8 times, after then stop. Turn off the appliance using the On/Off button. If the appliance is under standby mode, it will power off automatically after 30 minutes without any operation.
Turn off the water tap, unload the baskets	<p>Warning: Wait about 15 minutes before unloading the dishwasher to avoid scald, as the dishes and utensils are still hot and more susceptible to break.</p> <p>They could also be dried better. Unload the appliance, starting from the lower basket.</p>

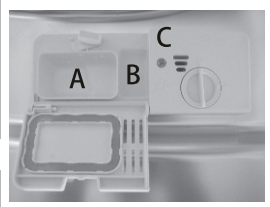

⚠ WARNING!
Open the door carefully.
Hot steam may escape
When the door is opened!



Read this Manual

Dear Customer,

This appliance is intended to be used in household and similar applications such as:

- Staff kitchen areas in shops, offices and other working environments;
- Farm houses;
- By clients in hotels, motels and other residential type environments;
- Bed and breakfast type environments.

- Please carefully read this Manual before using the dishwasher, it will help you to use and maintain the dishwasher properly.
- Keep it for reference in future.
- Pass it on to any subsequent owner of the appliance.
- This Manual contains sections on Safety Instructions, Operating Instructions, Installation Instructions, Troubleshooting Tips, etc.



Before Calling for Service

- Reviewing the Troubleshooting Tips will help you to solve some common problems by yourself.
- If you can not solve the problems by yourself, please ask for help from the professional technicians.



NOTE:

The manufacturer, following a policy of constant development and updating of the product, may make modifications without giving a prior notice.

This user manual shall also be got from the manufacturer or the responsible vendor.

1) Safety Information.....	1
2) Operating Instructions	2
Control Panel	2
Dishwasher Features	2
3) Prior Using for the First Time	3
A. Filling the Rinse Aid Dispenser	3
B. Function of Detergent.....	3
4) Loading the Dishwasher Basket.....	6
Attention before or after Loading the	
Dishwasher Baskets	6
The Method of Loading Normal Dishware	7
5) Starting a Washing Program	8
Washing Cycle Table.....	8
Turning on the Appliance	8
Changing the Program.....	8
At the End of the Washing Cycle.	9
6) Maintenance and cleaning.....	10
Filtering System	10
Caring for the Dishwasher	11
7) Installation Instructions.....	12
Positioning the Appliance.....	12
About Power Connection	12
Water Connection	13
Starting the Dishwasher.....	14
8) Troubleshooting Tips.....	15
Before Calling for Service	15
Error Codes.....	16
Technical Information.....	17

Loading the baskets according to (*AS/NZS 2007.1)

IMPORTANT SAFETY INFORMATION

READ ALL OF THE INSTRUCTIONS BEFORE USING

⚠ WARNING! When using your dishwasher, follow the precautions listed below:



GROUNDING INSTRUCTIONS

- This appliance must be grounded. In the event of a malfunction or breakdown, grounding will reduce the risk of an electric shock by providing a path of least resistance of electric current. This appliance is equipped with a cord having an equipment-grounding conductor and a grounding plug.
- The plug must be plugged into an appropriate outlet that is installed and grounded in accordance with all local codes and ordinances.

⚠ WARNING!

- Improper connection of the equipment-grounding conductor can result in the risk of an electric shock.
- Check with a qualified electrician or service representative if you are in doubt whether the appliance is properly grounded. Do not modify the plug provided with the appliance. If it does not fit the outlet, have a proper outlet installed by a qualified electrician.



WARNING! PROPER USE

- Do not abuse, sit on, or stand on the door or dish rack of the dishwasher.
- Do not touch the heating element during or immediately after use.
(This instruction is only applicable to machines with a visual heating element.)
- Do not operate your dishwasher unless all enclosure panels are properly in place. Open the door very carefully, because if the dishwasher is operating, there will be a risk of water squirting out.
- Do not place any heavy objects on or stand on the door when it is open. The appliance could tip forward.
- When loading items to be washed:
 - 1) Locate sharp items so that they are not likely to damage the door seal;
 - 2) Warning: Knives and other utensils with sharp points must be loaded in the basket with their points down or placed in a horizontal position.
- When using your dishwasher, you should prevent plastic items from coming into contact with the heating element. (This instruction is only applicable to machines with a visual heating element.)
- Check that the detergent compartment is empty after completion of the washing cycle.
- Do not wash plastic items unless they are marked with dishwasher safe or the equivalent. For plastic items not so marked, check the manufacturer's recommendations.
- Use only detergent and rinsing additives designed for an automatic dishwasher.
- Never use soap, laundry detergent, or hand washing detergent in your dishwasher. Keep these products out of the reach of children.
- Keep children away from detergent and rinse aid, keep children away from the open door of the dishwasher, there could still be some detergent left inside.
- This appliance is not intended for use by persons (including children) with reduced physical, sensory or mental capabilities, or lacking experience and knowledge, unless they have been given supervision or instruction concerning use of the appliance by a person responsible for their safety.
- Children should be supervised to ensure that they do not play with the appliance.
- Dishwasher detergents are strongly alkaline, they can be extremely dangerous if swallowed. Avoid contacting with skin and eyes and keep children away from the dishwasher when the door is open.
- The door should not be left open, since this could increase the risk of tripping.
- If the supply cord is damaged, it must be replaced by the manufacturer or its service agent or a similarly qualified person in order to avoid a hazard.
- Remove the door to the washing compartment when removing an old dishwasher from service or discarding it. Please dispose of packing materials properly.
- Use the dishwasher only for its intended function.
- During installation, the power supply must not be excessively or dangerously bent or flattened.
Do not tamper with controls.
- The appliance is to be connected to the water mains using new hose sets and the old hose-sets should not be reused.
- The maximum number of place settings to be washed is 12.
- The maximum permissible inlet water pressure is 1 Mpa.
- The minimum permissible inlet water pressure is 0.04Mpa.

READ AND FOLLOW THIS SAFETY INFORMATION CAREFULLY KEEP THESE INSTRUCTIONS

2. Operating Instructions

IMPORTANT To get the best performance from your dishwasher, read all operating instructions before using it for the first time.

Control Panel

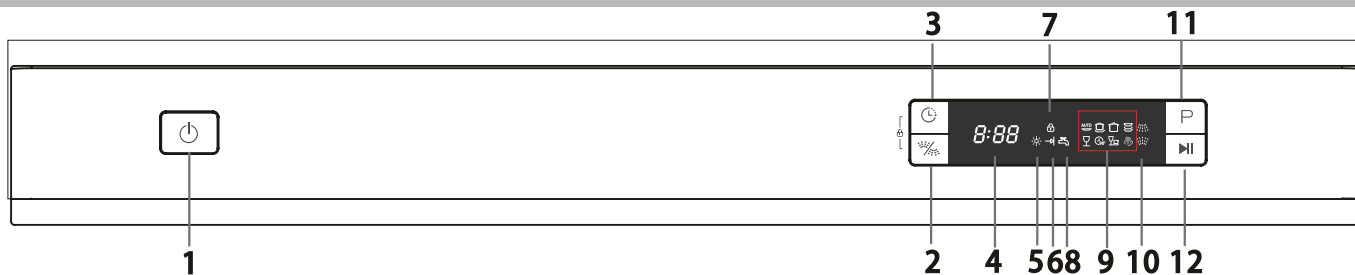

1. On/Off: To turn on/off the power supply.
2. Alt function button: Dual zone wash function, press the button to select either upper basket or lower basket loaded, and the response indicators will light up.
3. Delay button : Press the button to delay.
4. Display screen: Shows the reminding time (delay time).
5. Rinse aid warning light: To be on when the dispenser needs to be refilled.
6. Cycle finish light: →
To be on when the washing program is finished.
7. Child lock indicator: Press Alt function button and delay button simultaneously to lock the program.
8. Water tap indicator: The tap is not open or water inlet is not working.
9. Program indicators: Shows the program you choose;
10. Alt function indicators:
Upper basket loaded indicator: 🌿
Shows upper basket loaded function starting up or not;
Lower basket loaded indicator: 🌿
Shows lower basket loaded function starting up or not;
11. Program button: Press the button to select appropriate program.
12. Start/Pause: To start the selected washing program or pause the washing program when the machine is working.

Dishwasher Features

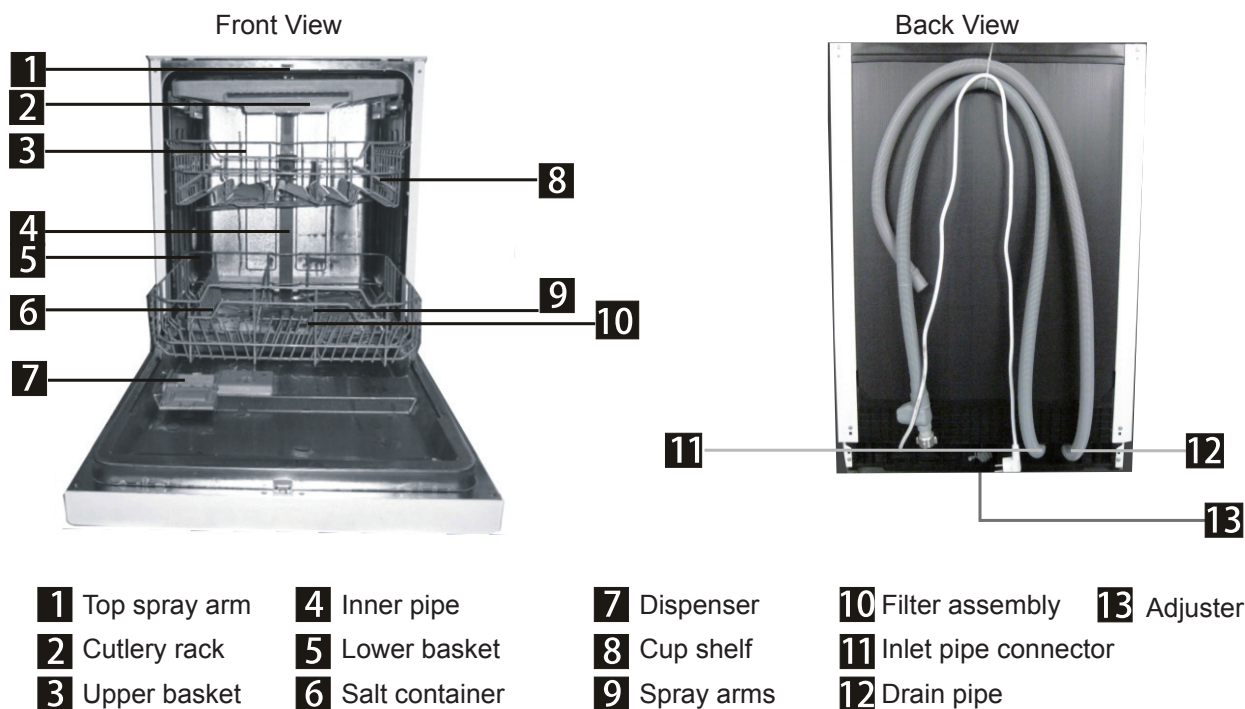

- | | | | | |
|------------------------|-------------------------|---------------------|--------------------------------|--------------------|
| 1 Top spray arm | 4 Inner pipe | 7 Dispenser | 10 Filter assembly | 13 Adjuster |
| 2 Cutlery rack | 5 Lower basket | 8 Cup shelf | 11 Inlet pipe connector | |
| 3 Upper basket | 6 Salt container | 9 Spray arms | 12 Drain pipe | |

3. Prior to Using for the First Time

Before using your dishwasher for the first time:

- A. Fill the rinse aid dispenser
- B. Add the detergent

A. Rinse Aid Dispenser

Rinse Aid Dispenser

The rinse aid is released during the final rinse to prevent water from forming droplets on your dishes, which can leave spots and streaks. It also improves drying by allowing water to roll off the dishes. Your dishwasher is designed to use liquid rinse aids. The rinse aid dispenser is located inside the door next to the detergent dispenser.

To fill the dispenser, open the cap and pour the rinse aid into the dispenser until the level indicator turns completely black. The volume of the rinse aid container is about 110ml.

Function of Rinse Aid

Rinse aid is automatically added during the last rinse, ensuring thorough rinsing, and spot and streak free drying.

Attention!

Only use branded rinse aid for dishwasher. Never fill the rinse aid dispenser with any other substances (e.g. dishwasher cleaning agent, liquid detergent). This would damage the appliance.

When to Refill the Rinse Aid Dispenser

If there is no rinse aid warning light in the control panel, you can judge the amount of rinse aid by the color of the optical level indicator "C" located next to the cap. When the rinse aid container is full, the whole indicator will be dark. As the rinse aid diminishes, the size of the dark dot decreases. You should never let the rinse aid get below 1 / 4 full.

As the rinse aid diminishes, the size of the black dot on the rinse aid level indicator changes, as illustrated below.

- Full
- 3 / 4 full
- 1 / 2 full
- 1 / 4 full - Should refill to eliminate spotting
- Empty

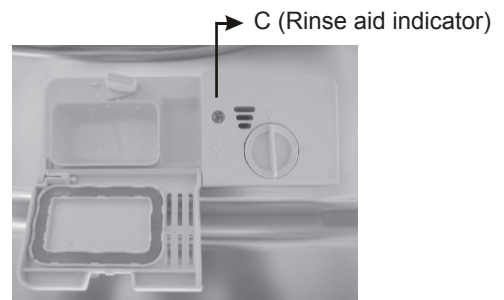

How to Fill the Rinse Aid Dispenser

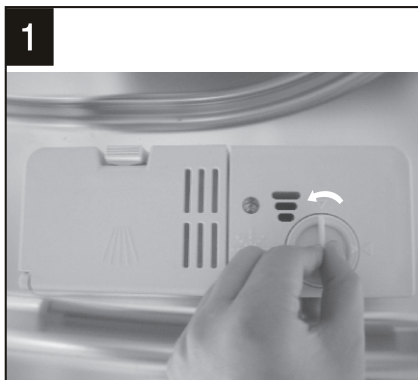

- 1 Open the dispenser, turn the cap to the "open" (left) arrow and lift it out.
- 2 Pour the rinse aid into the dispenser, and be careful not to overfill.
- 3 Replace the cap by inserting it aligned with "open" arrow and turning it to the closed (right) arrow.

Be careful not to overfill the dispenser, because this could cause over sudsing. Wipe away any spills with a damp cloth. Don't forget to replace the cap before you close dishwasher door.

Attention!

Clean up any rinse aid spilled during filling with an absorbent cloth to avoid excess foaming during the next wash.



NOTE: Clean up any rinse aid spilled during filling with an absorbent cloth to avoid excessive foaming during the next wash. Don't forget to replace the cap before you close dishwasher door.

Adjusting Rinse Aid Dispenser

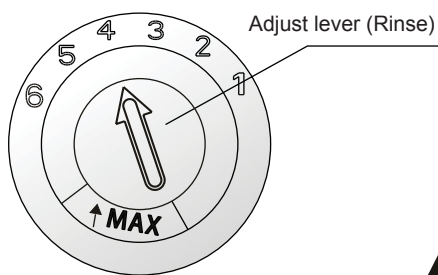

Adjust lever (Rinse). The rinse aid dispenser has six or four settings. Always start with the dispenser set on "4". If spots and poor drying are a problem, increase the amount of rinse aid dispensed by removing the dispenser lid and rotating the dial to "5". If the dishes still are not dried properly or show spots, adjust the dial to the next higher lever until your dishes are spot-free. The recommended setting is "4". (Factory value is "4".)



NOTE:

Increase the dose if there are drops of water or lime spots on the dishes after washing. Reduce it if there are sticky whitish stains on your dishes or a bluish film on glassware or knife blades.

B. Detergent

Detergents have chemical ingredients that are necessary to remove dirt, crush dirt and transport it out of the dishwasher. Most of the commercial quality detergents are suitable for this purpose.

Detergent

There are 3 sorts of detergents

1. With phosphate and with chlorine
2. With phosphate and without chlorine
3. Without phosphate and without chlorine

Normally new pulverized detergent is without phosphate. Thus the water softener function of phosphate is not given. If detergents without phosphate are used in the case of hard water, often white spots appear on dishes and glasses. In this case, please add more detergent to reach better results. Detergents without chlorine do only bleach a little. Strong and coloured spots will not be removed completely. In this case, please choose a program with a higher temperature.

Concentrated Detergent

Based on their chemical composition, detergents can be split in two basic types:

- Conventional, alkaline detergents with caustic components
- Low alkaline concentrated detergents with natural enzymes

The use of normal washing program in combination with concentrated detergents reduces pollution and is good for your dishes; The washing program is specifically matched to the dirt-dissolving properties of the enzymes of the concentrated detergent. For this reason, an normal washing program in which concentrated detergents are used can achieve the same results that can otherwise only be achieved using an intensive program.

Detergent Tablet

Detergent tablets of different brands dissolve at different speeds. For this reason, some detergent tablets cannot dissolve and develop their full cleaning power during short programs.

Therefore please use long programs when using detergent tablets, to ensure the complete removal of detergent residuals.

Detergent Dispenser

The dispenser must be refilled before the start of each washing cycle following the instructions provided in the Washing Cycle Table . Your dishwasher uses less detergent and rinse aid than conventional dishwasher. Generally, only one tablespoon of detergent is needed for a normal wash load. More heavily soiled items need more detergent. Always add the detergent just before starting the dishwasher, otherwise it could get damp and will not dissolve properly.

Adding Detergent into Dispenser

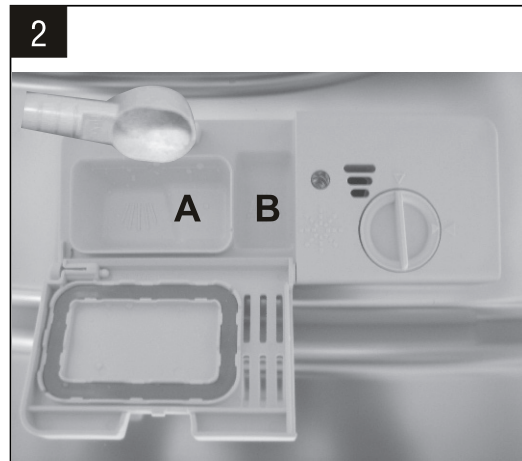
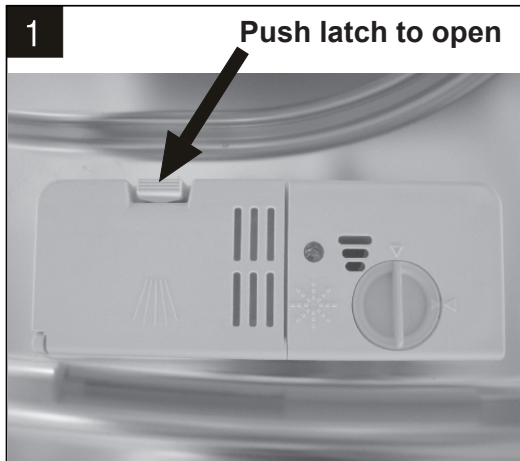

Add the Detergent

Fill the detergent dispenser with detergent.

The marking indicates the dosing level, as illustrated on the right:

A For main wash detergent.

B For pre-wash detergent.

Use only detergent specifically made for the use in dishwashers. Keep your detergent fresh and dry. Don't put powdered detergent into the dispenser until you're ready to wash dishes.

Please observe the manufacturers dosing and storage recommendations as stated on the detergent packaging.

Close the lid and press until it is locked in place.

If the dishes are heavily soiled, place an additional detergent dose in the pre-wash detergent chamber. This detergent will take effect during the pre-wash phase.

NOTE:

- You see information about the amount of detergent for the single programme on the last page.
- Please be aware that soiling levels and water hardness can effect wash results.
- Please observe the manufacturer's recommendations on the detergent packaging.
- If the lid is closed: push the latch to open.
- Always add the detergent just before starting each wash cycle.
- Only use branded detergent and rinse aid for dishwasher.



WARNING!

Dishwasher detergent is corrosive!
Take care to keep it out of reach of children.

4. Loading the Dishwasher Baskets

Recommendation

- Consider buying utensils which are identified as dishwasher-proof.
- Use a mild detergent that is described as 'kind to dishes'. If necessary, seek further information from the detergent manufacturers.
- For particular items, select a program with as low temperature as possible.
- To prevent damage, do not take glass and cutlery out of the dishwasher immediately after the program has ended.

Suitability of Use in the Dishwasher

Not suitable for use

- Cutlery with wooden, horn china or mother-of-pearl handles.
- Plastic items that are not heat resistant.
- Older cutlery with glued parts that are not temperature resistant.
- Bonded cutlery items or dishes.
- Pewter or cooper items.
- Crystal glass.
- Steel items subject to rusting.
- Wooden platters.
- Items made from synthetic fibres.

Limited suitability

- Some types of glasses can become dull after a large number of washes.
- Silver and aluminum parts have a tendency to discolour during washing.
- Glazed patterns may fade if washed by machines frequently.

Attention before or after Loading the Dishwasher Baskets

(For the best performance of the dishwasher, follow these loading guidelines. Features and appearance of baskets and cutlery baskets may vary from model to model.)

Scrape off any large food particles. Soften remnants of burnt food in pans.

It is not necessary to rinse the dishes under running water.

Place objects in the dishwasher in the following way:

1. Items such as cups, glasses, pots/pans, etc. are placed face downwards.
2. Curved items, or ones with recesses, should be loaded aslant so that water can run off.
3. All utensils are stacked securely and can not tip over.
4. All utensils are placed in the way that the spray arms can rotate freely during washing.



NOTE: Very small items should not be washed in the dishwasher as they could easily fall out of the basket.

- Load hollow items such as cups, glasses, pans, etc. with the opening downwards, so that water can't be collected in the container or a deep base.
- Dishes and items of cutlery must not lie inside one another, or cover each other.
- To avoid damage to glasses, they must not be touched with each other.
- Load large items which are the most difficult to clean into the lower basket.
- The upper basket is designed to hold more delicate and lighter dishware such as glasses, coffee and tea cups.
- Long bladed knives stored in an upright position are a potential hazard!
- Long and/or sharp items of cutlery such as carving knives must be positioned horizontally in the upper basket.
- Please do not overload your dishwasher, which is important for good results and for reasonable consumption of energy.

Removing the Dishes

To prevent water dripping from the upper basket into the lower basket, we recommend that you empty the lower basket first and then the upper basket.

■ The Method of Loading Normal Dishware

Loading the Upper Basket

The upper basket is designed to hold more delicate and lighter dishware such as glasses, coffee and tea cups and saucers, as well as plates, small bowls and shallow pans (as long as they are not too dirty).

Position the dishes and cookware so that they will not get moved by the spray of water.

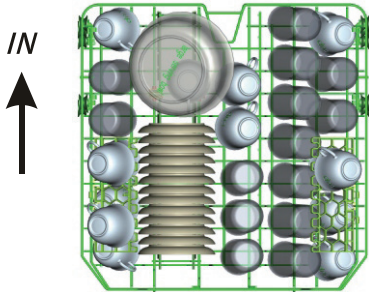

Please be reminded that:

- Pots, serving bowls, etc, must always be placed top down.
- Deep pots should be slanted to allow water to flow out.
- The bottom basket features folding spikes so that larger or more pots and pans can be loaded.

Loading the Lower Basket

We suggest that you place large items and the most difficult to clean items into the lower basket: such as, pots, pans, lids, serving dishes and bowls, as shown in the figure below. It is preferable to place serving dishes and lids on the side of the racks in order to avoid blocking the rotation of the top spray arm.

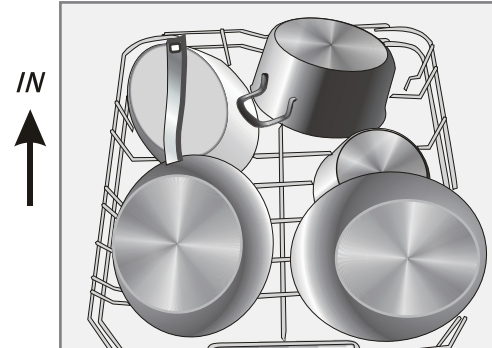

Adjusting the Upper Basket

The height of the upper basket can be adjusted in order to create more space for large utensils both for the upper /lower basket. The height of the upper basket can be adjusted by placing the wheels on different height of the rails. Long items, serving cutlery, salad servers and knives should be placed on the shelf so that they do not obstruct the rotation of the spray arms.

Lower position



Upper position



Wheels

Folding back the Cup Shelves

For better stacking of pots and pans, the spikes can be folded down as shown in the picture right.

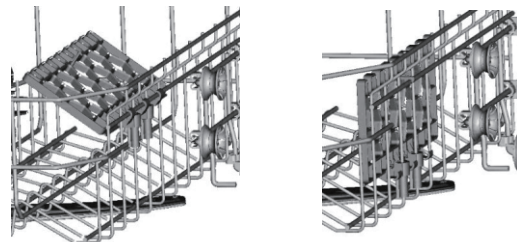

Folding Spikes of Lower Basket

For better stacking of pots and pans, the spikes can be folded down as shown in the picture right.



Cutlery Basket

Cutlery should be placed into the cutlery rack separate from each other in the appropriate position, and make sure the utensils do not rest together, because this may cause bad performance.

For a top quality cleaning, place the silverware in the basket making sure that:



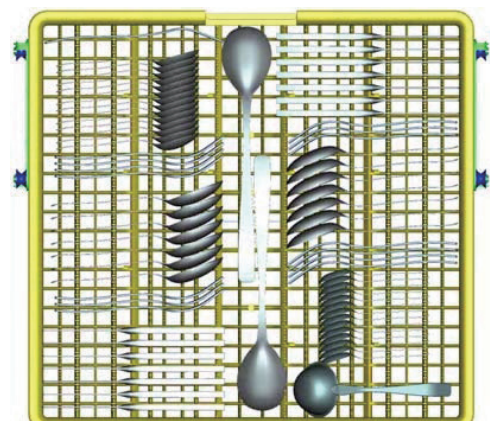

- They do not nest together.
- Silverware is placed with the male face up.
- Long utensils are placed in the middle.



5. Starting a Washing Program

Washing Cycle Table

NOTE: (★) Means: need to fill rinse aid into the Rinse-Aid Dispenser.

Program	Cycle Selection Information	Description of Cycle	Detergent Pre/Main	Running Time(min)	Energy (Kwh)	Water (L)	Rinse Aid
Auto 	Auto sensing wash, lightly, or heavily soiled crockery, with or without dried food.	Prewash (45 °C) Autowash (45-55 °C) Rinse Rinse (65 °C) Drying	<i>5/27.5g</i> (Or all in 1)	150	0.9~1.3	11~15	★
Intensive 	For the heaviest soiled loads, such as pots, pans, casserole dishes and dishes that have been sitting with dried food on them for a while.	Prewash (50 °C) Wash (60 °C) Rinse Rinse (65 °C) Drying Prewash	<i>5/27.5g</i> (Or all in 1)	170	1.5	17.5	★
Heavy 	For heavily soiled loads, such as pots, plates, glasses and lightly soiled pans.	Prewash (45 °C) Wash (55 °C) Rinse Rinse (65 °C) Drying	<i>5/27.5g</i> (Or all in 1)	160	1.3	13.5	★
Normal  <small>(*AS/NZS 2007.1)</small>	For normally soiled loads, such as pots, plates, glasses and lightly soiled pans, standard daily cycle.	Prewash Wash (45 °C) Rinse (48 °C) Drying	<i>5/27.5g</i> (Or all in 1)	170	0.7	12	★
Glass 	For lightly soiled loads, such as glasses, crystal and fine china.	Prewash Wash (42 °C) Rinse Rinse (60 °C) Drying	<i>5/27.5g</i> (Or all in 1)	125	0.8	13	★
90 min 	For lightly soiled crockery and glass.	Wash (65 °C) Rinse Rinse (65 °C) Drying	<i>25g</i> (Or all in 1)	90	1.2	11.5	★
Rapid 	A shorter wash for lightly soiled loads that do not need drying.	Wash (40 °C) Rinse Rinse (45 °C)	25g	30	0.6	11.5	/
Soak 	To rinse dishes that you plan to wash later that day.	Prewash	/	8	0.02	4	/

NOTE:

*AS/NZS 2007.1 : This program is the test cycle. The information for comparability test in accordance with AS/NZS 2007.1 is as follows:

- Capacity: 14 setting
- Upper basket position: upper wheels on rails
- Rinse aid setting: 6
- Open the door slightly 50mm to assist in drying of the dishes after every wash

Turning on the Appliance

Starting a cycle wash

- 1 Draw out the lower and upper baskets, load the dishes and push them back. It is recommended to load the lower basket first, then the upper one (see the section entitled Loading the Dishwasher Basket).
- 2 Pour in the detergent (see the section entitled Detergent and Rinse Aid).
- 3 Insert the plug into the socket. The power supply is 220-240 VAC /50 HZ, the specification of the socket is 10A 250VAC. Make sure that the water supply is turned on to full pressure.
- 4 Close the door, press the On/Off button to switch on the machine.
- 5 Press the program button, the washing program will be changed as the following direction:
Normal->Glass->90min->Rapid->Soak->Auto->Intensive->Heavy
If a program is selected, the responding light will be on. Then press the Start/Pause button, the dishwasher starts.

NOTE:

When you press the Start/Pause button to pause during washing, the LED display window "000" will stop blinking and the dishwasher will beep every minute unless you press the Start/Pause button again to start.

Changing the Program

Premise:

- 1 A cycle that is underway can only be modified if it has only been running for a short time. Otherwise, the detergent may have already been released, and the appliance may have already drained the wash water.
In this case, the detergent dispenser must be refilled (see the section entitled "Detergent").
- 2 Press the Start/Pause button, the machine will be in a standby state. Press the program button for more than 3s, then you can change the program to the desired cycle setting (see the section entitled "Starting a Washing Program")
- 3 The LED display shows the state of the dishwasher:
 - a) The screen shows H MM and the colon icon does not blink-----Stand-by or being paused
 - b) The screen shows H MM and the colon icon blinks-----Running

NOTE:

If you open the door during a wash cycle , the machine will pause. The LED display window "000" will stop blinking and the buzzer will beep every minute unless you close the door. After you close the door, the machine will keep on working after 10 seconds.

Forgetting to Add a Dish

A forgotten dish can be added any time before the detergent cup opens.

- 1 Press the Start/Pause button to stop the washing.
- 2 Open the door a little.
- 3 After the spray arms stop working, you can open the door completely.
- 4 Add forgotten dishes.
- 5 Close the door.
- 6 Press the Start/Pause button, the dishwasher will run after 10 seconds.

At the End of the Washing Cycle

When the working cycle has finished, the buzzer of the dishwasher will sound for 8 seconds, then stop. Turn off the appliance using the ON/OFF button, shut off the water supply and open the door of the dishwasher.

Wait for a few minutes before unloading the dishwasher to avoid scalding. The dishes and utensils are still hot and more susceptible to breakage. They will also be dried better.

Switch off the Dishwasher

- The LED screen is on but the colon icon is not blinking, and only in this case the program has ended.
 1. Switch off the dishwasher by pressing the ON/OFF button.
 2. Turn off the water tap.

Open the Door Carefully.

- Hot dishes are sensitive to knocks. The dishes should be allowed to cool down around 15 minutes before removed from the appliance.
Open the dishwasher's door, leave it ajar and wait a few minutes before removing the dishes. In this way they will be cooler and the drying will be improved.

Unload the Dishwasher

- It is normal that the dishwasher is wet inside.
Empty the lower basket first and then the upper one. This will avoid water dripping from the upper basket on to the dishes in the lower one.

 **WARNING!** It is dangerous to open the door when washing, because the hot water may scald you.

6. Maintenance and Cleaning

Filtering System

The filter prevents larger remnants of food or other objects from getting inside the pump. The residues may block the filter. In this case they must be removed.

The filter system consists of a coarse filter, a flat filter (main filter) and a micro filter (fine filter).

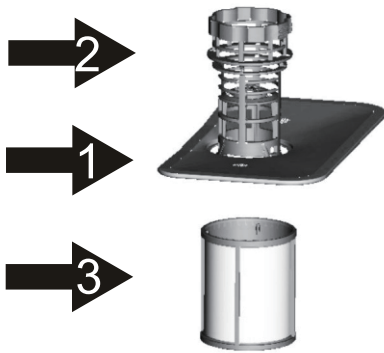

Main filter 1

Food and soil particles trapped in this filter are pulverized by a special jet on the lower spray arm and washed down to drain.

Coarse filter 2

Larger items, such as pieces of bones or glass, which could block the drain, are trapped in the coarse filter. To remove the items caught in this filter, gently squeeze the tap on the top of this filter and lift it out.

Fine filter 3

This filter holds soil and food residues in the sump area and prevents them from being redeposited on the dishes during washing cycle.

Filter Assembly

The filter efficiently removes food particles from the wash water, allowing it to be recycled during the cycle. For best performance and results, the filter must be cleaned regularly. For this reason, it is a good idea to remove the larger food particles trapped in the filter after each washing cycle by rinsing the semicircular filter and cup under running water. To remove the filter device, pull the cup handle in a upward direction.

⚠ WARNING!

The dishwasher must never be used without the filters. Improper replacement of the filter may reduce the performance level of the appliance and damage dishes and utensils.

1

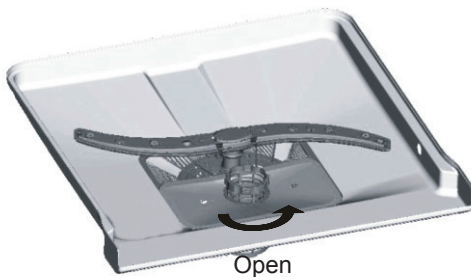

Step 1 Turn the filter in anti-clockwise direction.

2



Step 2 Lift the filter assembly up.



NOTE: When following this procedure from Step 1 to Step 2, the filter system will be removed; When following from Step 2 to Step 1, the filter system will be installed.

Notes:

- Inspect the filters for blocking after every time the dishwasher has been used.
- By unscrewing the coarse filter, you can remove the filter system. Remove any food remnants and clean the filters under running water.

NOTE: The entire filter assembly should be cleaned once a week.

Cleaning the Filter

To clean the coarse filter and the fine filter, use a cleaning brush. Reassemble the filter parts as shown in the figures on the last page and reinsert the entire assembly in the dishwasher, positioning it in its seat and pressing downwards.

WARNING! When cleaning the filters, don't knock on them. Otherwise, the filters could be contorted and the performance of the dishwasher could be decreased.

Caring for the Dishwasher

The control panel can be cleaned by using a lightly dampened cloth. After cleaning, make sure to dry it thoroughly.

For the exterior, use a good appliance polish wax. Never use sharp objects, scouring pads or harsh cleaners on any part of the dishwasher.

Cleaning the Door

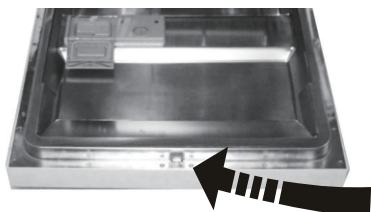

To clean the edge around the door, you should use only a soft warm, damp cloth. To avoid penetration of water into the door lock and electrical components, do not use a spray cleaner of any kind.

WARNING!

Never use a spray cleaner to clean the door panel as it may damage the door lock and electrical components. Abrasive agents or some paper towels should not be used because of the risk of scratching or leaving spots on the stainless steel surface.

Protect against Freezing

Please take frost protection measures on the dishwasher in winter. Every time after washing cycles, please operate as follows

1. Cut off the electrical power to the dishwasher.
2. Turn off the water supply and disconnect the water inlet pipe from the water valve.
3. Drain the water from the inlet pipe and water valve. (Use a pan to gather the water)
4. Reconnect the water inlet pipe to the water valve.
5. Remove the filter at the bottom of the tub and use a sponge to soak up water in the sump.

NOTE: *If your dishwasher cannot work because of the ice, please contact professional service personnel.*

Cleaning the Spray Arms

It is necessary to clean the spray arms regularly for hard water chemicals will clog the spray arm jets and bearings.

To remove the upper spray arm, hold the nut, rotate the arm clockwise to remove it.

To remove the lower spray arm, pull out the spray arm upward.

Wash the arms in soapy and warm water and use a soft brush to clean the jets. Replace them after rinsing them thoroughly.

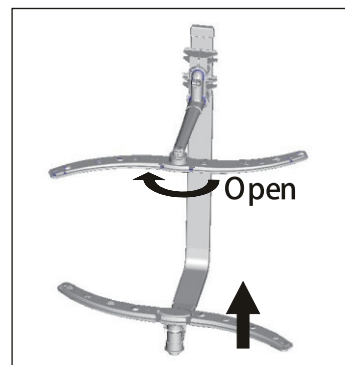

How to Keep Your Dishwasher in Shape

■ After Every Wash

After every wash, turn off the water supply to the appliance and leave the door slightly open so that moisture and odours are not trapped inside.

■ Removing the Plug

Before cleaning or performing maintenance, always remove the plug from the socket.

■ No Solvents or Abrasive Cleaning

To clean the exterior and rubber parts of the dishwasher, do not use solvents or abrasive cleaning products. Only use a cloth with warm soapy water. To remove spots or stains from the surface of the interior, use a cloth dampened with water and a little vinegar, or a cleaning product made specifically for dishwashers.

■ When Not in Use for a Long Time

It is recommended that you run a washing cycle with the dishwasher empty and then remove the plug from the socket, turn off the water supply and leave the door of the appliance slightly open. This will help the door seals last longer and prevent odours forming within the appliance.

■ Moving the Appliance

If the appliance must be moved, try to keep it in the vertical position. If absolutely necessary, it can be positioned on its back.

■ Seals

One of the factors that cause odours to form in the dishwasher is food that remains trapped in the seals. Periodic cleaning with a damp sponge will prevent it.

Installation Instructions

Positioning the Appliance

Position the appliance in the desired location. The back should rest against the wall behind it, and the sides, along the adjacent cabinets or walls. The dishwasher is equipped with water supply and drain hoses that can be positioned to either the right or the left side to facilitate proper installation.

Levelling the Appliance

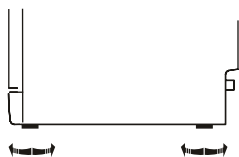

Once the appliance is positioned for levelling, the height of the dishwasher may be altered via adjustment of the screwing level of the feet.

About Power Connection

▲ WARNING!

For personal safety:
DO NOT USE AN EXTENSION CORD OR AN ADAPTER PLUG WITH THIS APPLIANCE.
DO NOT, UNDER ANY CIRCUMSTANCES, CUT OR REMOVE THE GROUNDING CONNECTION FROM THE POWER CORD.

Electrical Requirements

Please look at the rating label to know the rating voltage and connect the dishwasher to the appropriate power supply. Use the required fuse 10 amp, time delay fuse or circuit breaker recommended and provide separate circuit serving only this appliance.

Electrical Connection

▲ Insure proper grounding before use

Ensure the voltage and frequency of the power being correspond to those on the rating plate. Only insert the plug into an electrical socket which is grounded properly. If the electrical socket to which the appliance must be connected is not appropriate for the plug, replace the socket, rather than using adapters or the like as they could cause overheating and burns.



Earthing Instructions

This appliance must be grounded. In the event of a malfunction or breakdown, grounding will reduce the risk of electric shock by providing a path of least resistance for the electric current. This appliance is equipped with a cord having an equipment-grounding conductor and an grounding plug. The plug must be plugged into an appropriate outlet that is installed and grounded in accordance with all local standards and requirements.

How to Connect the Safety Supply Hose

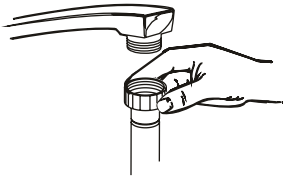

The appliance must be connected to the water mains using new hose-sets. The old hose-sets should not be reused.

Water pressure must be between 0.04 MPa and 1 MPa. If the pressure is below the minimum, consult our Service Department for advice.

1. Pull the safety supply hoses completely out from storage compartment located at the rear of the dishwasher.
2. Tighten the screws of the safety supply hose to the faucet with thread 3/4 inch.
3. Turn the water fully on before starting the dishwasher.

About the Safety Supply Hose

The safety supply hose consists of double walls. The hose system guarantees its intervention by blocking the flow of water when the supply hose breaks and the space between the supply hose itself and the outer corrugated hose is full of water.

▲ WARNING!

A hose attached to a sink spray can burst if it is installed on the same water line as the dishwasher. If you have one sink, it is recommended that the hose be disconnected and the hole plugged.

How to Disconnect the Safety Supply Hose

1. Turn off the water.
2. Release the water pressure by pressing the pressure release button. In this way, water pressure will be relieved, protecting you and the room from severe splashing.
3. Unscrew the safety supply hose from the faucet.

Cold Water Connection

Connect the cold water supply hose to a threaded 3/4 (inch) connector and make sure that it is fastened tightly in place. If the water hoses are new or have not been used for an extended period of time, let the water run out firstly to make sure that the water is clear and free of impurities. If this precaution is not taken, there will be a risk that the water inlet gets blocked and the appliance is damaged.

Drain Hose Connection

Insert the drain hose into a drain pipe with a minimum diameter of 40mm, or let it run into the sink, avoiding bending or crimping it. The top of the hose must be less than 1000mm

▲ PLEASE HANG UP THE DRAIN HOSE IN EITHER WAY OF A, B

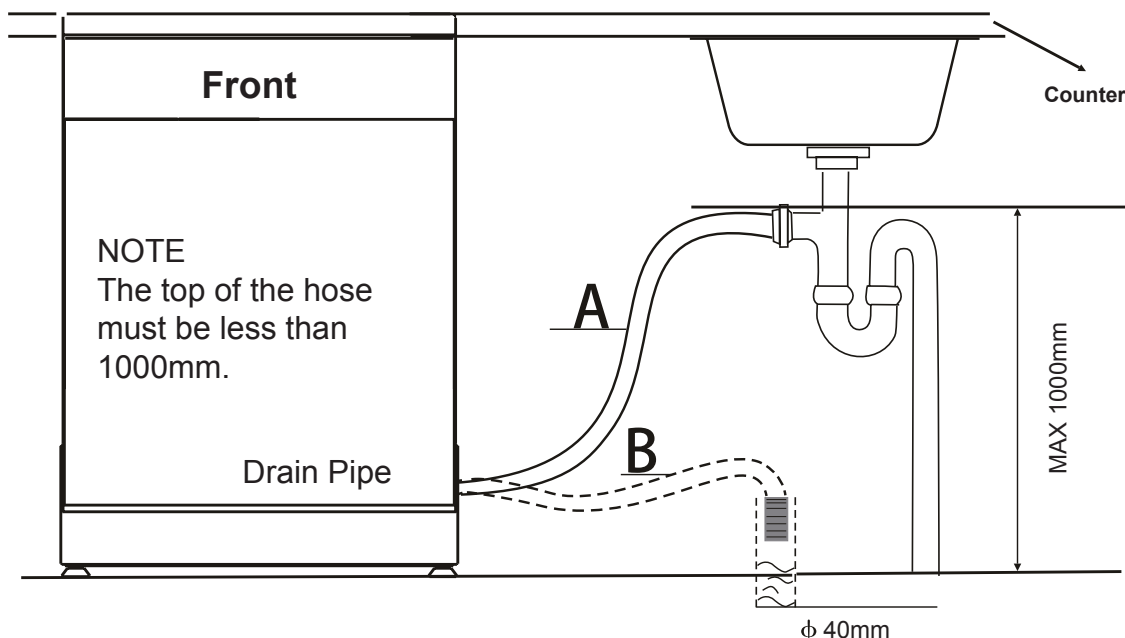

How to Drain Excess Water from Hoses

If the sink is more than 1000mm higher than the floor, the excess water in hoses cannot be drained directly into the sink. It will be necessary to drain excess water from hoses into a bowl or suitable container that is held outside and lower than the sink.

Water Outlet

Connect the water drain hose. The drain hose must be correctly fitted to avoid water leaking. Ensure that the water drain hose is not kinked or squashed.

Extension Hose

If you need a drain hose extension, make sure to use a similar drain hose. It must be no longer than 4 metres, otherwise the cleaning effect of the dishwasher could be reduced.

Syphon Connection

The waste connection must be at a height less than 1000 mm (maximum) from the bottom of the dish. The water drain hose should be fixed.

Starting the Dishwasher

The following things should be checked before starting the dishwasher.

- 1 The dishwasher is level and fixed properly.
- 2 The inlet valve is open.
- 3 There is a leakage at the connections of the conducts.
- 4 The wires are tightly connected.
- 5 The power is switched on.
- 6 The inlet and drain hoses are knotted.
- 7 All packing and printing materials should be taken out of the dishwasher.



Attention: After installation, please make sure to keep this Manual.

The content of this Manual is very helpful to users.

Troubleshooting Tips

Before Calling for Service

Reviewing the charts on the following pages may save you from calling for service.



	Problems	Possible Causes	What to Do
Technical problems		Fuse blown, or the circuit breaker acted	Replace fuse or reset circuit breaker. Remove any other appliances sharing the same circuit with the dishwasher.
		Power supply is not turned on	Make sure the dishwasher is turned on and the door is closed securely. Make sure the power cord is properly plugged into the wall socket.
		Error code: E1; Water pressure is low	Check that the water supply is connected properly and the water is turned on.
		Door of dishwasher not properly closed.	Make sure to close the door properly and latch it.
	<i>Water not pumped from dishwasher</i>	Kink in drain hose	Check drain hose.
		Filter clogged	Check the coarse filter (see section titled "Cleaning the Filter")
		Kitchen sink clogged	Check the kitchen sink to make sure it is draining well. If the problem is the kitchen sink not draining, you may need a plumber rather than a serviceman for dishwashers.
General problems	<i>Suds in the tub</i>	Improper detergent	Use only the special dishwasher detergent to avoid suds. If this occurred, open the dishwasher and let suds evaporate. Add 1 gallon of cold water to the tub. Close and latch the dishwasher, then select any cycle. Dishwasher will drain out the water at the first step. Open the door after draining stops and check if the suds disappear. Repeat if necessary.
		Spilled rinse-aid	Always wipe up rinse-aid spills immediately.
	<i>Stained tub interior</i>	Detergent with colourant is used	Make sure that the detergent is the one without colourant.
	<i>White film on inside surface</i>	Hard water minerals	To clean the interior, use a damp sponge with dishwasher detergent and wear rubber gloves. Never use any other cleaner than dishwasher detergent with the risk of foaming or suds.
	<i>There are rust stains on cutlery</i>	The affected items are not corrosion resistant.	The items should be corrosion resistant.
Noise	<i>Knocking noise in the wash cabinet</i>	A spray arm is knocking against an item in a basket.	Interrupt the program, and rearrange the items which are obstructing the spray arm.
	<i>Rattling noise in the wash cabinet</i>	Items of crockery are loose in the wash cabinet.	Interrupt the program, and rearrange the items of crockery.
	<i>Knocking noise in the water pipes</i>	This may be caused by on-site installation or the cross-section of the piping.	This has no influence on the dishwasher function. if in doubt, contact a suitably qualified plumber.



	Problems	Possible Causes	What to Do
Unsatisfactory washing result	<i>The dishes are not clean</i>	The dishes are not loaded correctly.	See notes in "Loading the Dishwasher Baskets".
		The program is not powerful enough.	Select a more intensive program. See "Washing Cycle Table".
		Not enough detergent is dispensed.	Use more detergent, or change your detergent.
		Items are blocking the path of spray arms.	Rearrange the items so that the sprayer can rotate freely.
		The filter combination is not clean or is not correctly fitted. This may cause the spray arm jets get blocked.	Clean and/or fit the filter combination correctly. Clean the spray arm jets. See "Cleaning the Spray Arms".
	<i>Cloudiness on glassware</i>	Combination of soft water and too much detergent.	Use less detergent if you have soft water and select a shortest cycle to wash the glassware and to get them clean.
	<i>Black or gray marks on dishes</i>	Aluminum utensils have rubbed against dishes.	Use a mild abrasive cleaner to eliminate those marks.
	<i>Detergent left in dispenser cups</i>	Dishes block detergent cup opens.	Re-loading the dishes properly.
Unsatisfactory drying result	<i>The dishes are not drying</i>	Improper loading	Load the dishwasher as suggested in the instructions.
		Too little rinse-aid	Increase the amount of rinse-aid/refill the rinse-aid dispenser.
		Dishes are removed too soon	Do not empty your dishwasher immediately after washing. Open the door slightly so that the steam can escape. Begin unloading the dishwasher only when the dishes are barely warm by touching. Empty the low basket first. This prevents water from dropping from dishes in the upper basket.
		Wrong program has been selected	In short program, the rinse temperature is lower. This also lowers cleaning performance. Choose a program with a long high rinse temperature.
		Use of cutlery with a low-quality coating	Water drainage is more difficult with these items. Cutlery or dishes of this type are not suitable for washing in the dishwasher.

Error Codes

In case of malfunctions, the appliance will display error codes to warn you:

Codes	Meanings	Possible Causes
E1	Longer inlet time.	The faucet is not opened, or water intake is restricted, or water pressure
E3	Not reach the setting temperature.	Malfunction of heating elements.
E4	Overflow.	Some element of the dishwasher leaks.
E8	Failure of orientation of distributary valve.	Circuit is open or broken distributary valve.
Ed	Failure of communication between main pcb with diplay pcb.	OpenCircuit or breakof wiring for the communication.

⚠ WARNING!

If overflow occurs, turn off the main water supply before calling a service. If there is water in the base pan because of an overfill or small leak, the water should be removed before restarting the dishwasher.

Technical Information

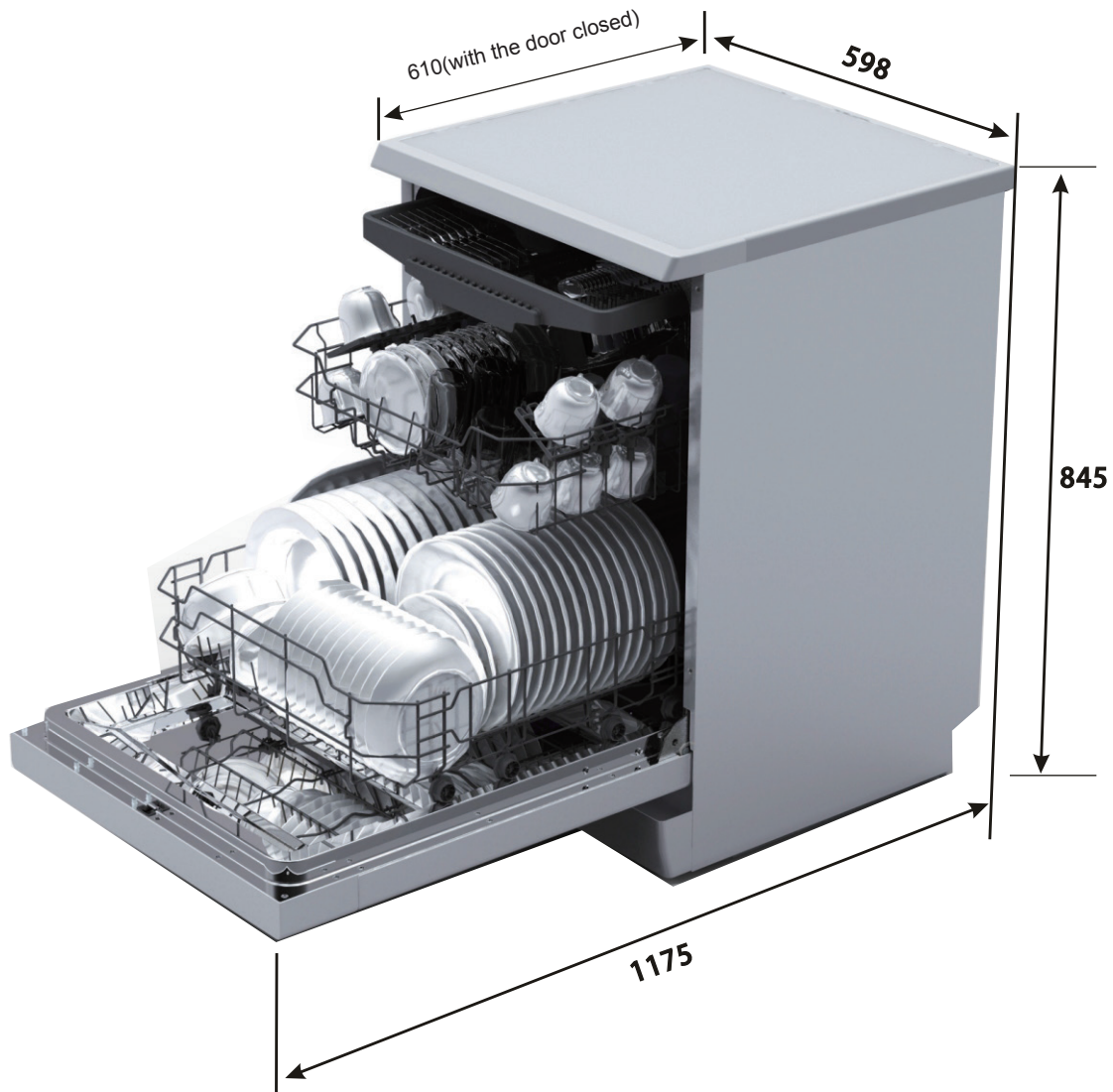

Height:	845mm
Width:	598mm
Depth:	610mm (with the door closed)
Water pressure:	0.04-1.0MPa
Power supply:	See rating label
Capacity:	14 place settings

Loading the baskets according to En 50242:

1. Upper basket:

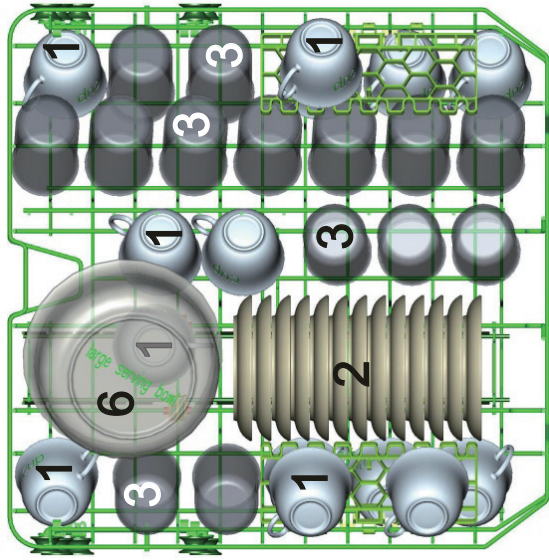

Cups



Saucers



Glasses



Small serving bowl



Medium serving bowl



Large serving bowl



Dessert dishes



Dinner plates



Soup plates

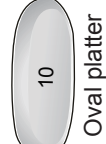

Oval platter

2. Lower basket:

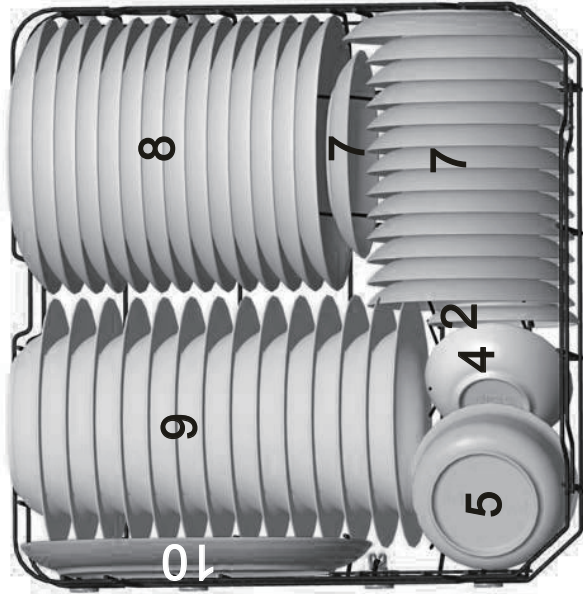

3. Cutlery basket:

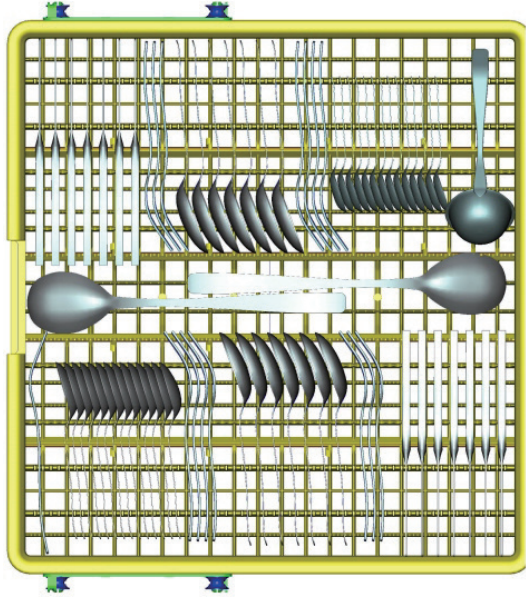

1 Soup spoons



2 Forks



3 Knives



4 Teaspoons



5 Dessert spoons



6 Serving spoons



7 Serving forks



8 Gravy ladles



Information for comparability tests in accordance with (*AS/NZS 2007.1)

- Capacity: 14 place settings
- Upper basket position: lower
- Program: Normal
- Rinse aid setting: 6
- Detergent (pre/main): 5 g/27.5 g
- Open the door at the end of the drying cycle for testing the drying performance (door position: open 50 mm)