

Product Specification Sheet

Product Title:	LED 3-Wires Track Light (10W)
SKU:	SL-10WTLD (3000K / 5000K)
Product Net Weight:	0.55 kg
Product Dimensions:	Ø60*188mm

Specifications:

	SL-10WTLD (3000K)	SL-10WTLD (5000K)
Model:	SL-10WTLD (3000K)	SL-10WTLD (5000K)
Power:	10W	10W
Power Factor:	>0.9	>0.9
Input Voltage:	AC220-240V	AC220-240V
Power Frequency:	50Hz	50Hz
LPW	93lm/w	98lm/w
Lumen Output:	930lm	980lm
Colour Temperature:	3000K	5000K
CRI:	>80	>80
Beam Angle:	36°	36°
Luminaire Net Weight:	0.63±0.05kg	0.63±0.05kg
Dimmable:	Yes	Yes
LED Chip:	1PCS COB	1PCS COB
IP:	IP20	IP20
Working Temperature:	-30~+30°C	-30~+30°C
Storing Temperature:	-40~+70°C	-40~+70°C
Colour Fitting:	Black/White	Black/White



Warranty Period

3 Years commencing from purchase date (Coverage only for usage in AU/NZ)

Image shown is for illustration purposes only. Actual product may vary.

Dimensions:

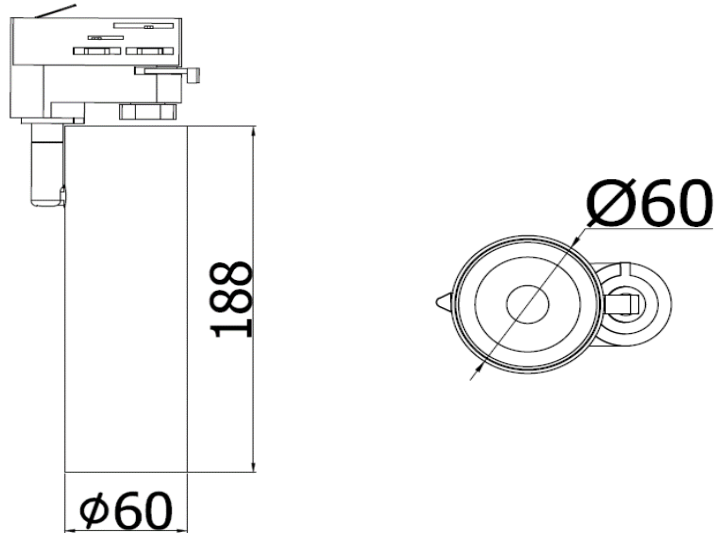

Compatible Accessories **available for sale:**

Track Rail (1m; include power feed & end cap), straight joiner, elbow joiner, "T" joiner, cross joiner, suspension kit & wire (1m; 2m; 3m)

