

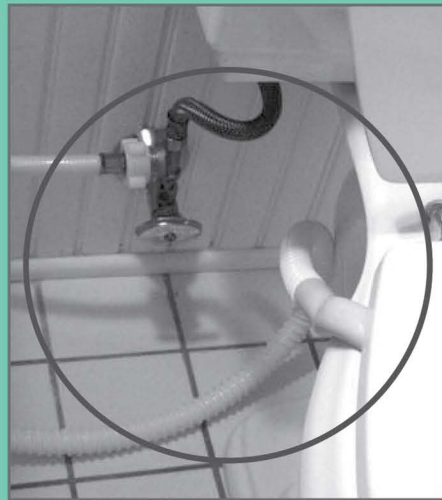

The World's Only Self-Flushing, Self-Washing Cat Box™

YOUR GUIDE to SUCCESSFUL OPERATION of the CATGENIE 120



Check
catGenie.com
for Manual
updates

**TIP: Watch Video of What to Expect During Cleaning
at CatGenie.com**



You own the new **CatGenie**® 120 model.
The 120 has new features suggested by current CatGenie 120 owners.

CatGenie Gives You 4 Ways to Customize Cat Activation

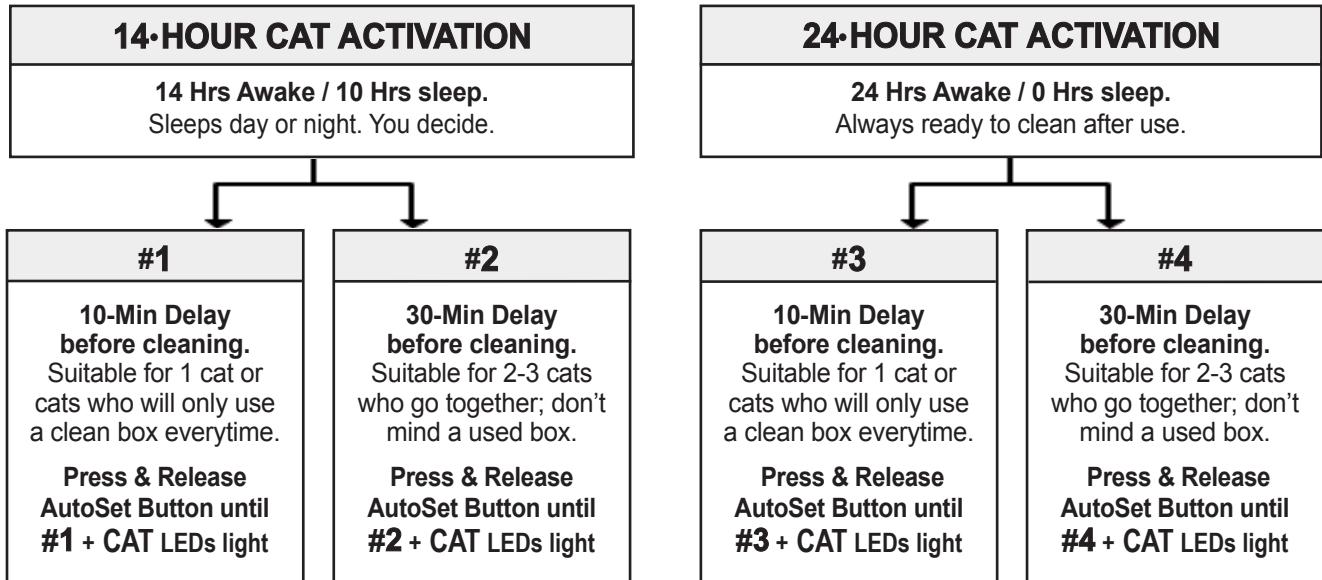

Set at the time you want your CatGenie to wake up.
In 1 & 2, you **MUST** lock in your start-time.
Press & Hold AutoSet for 4 seconds.

Do at any time to begin the 24 hour setting.
Press & Hold AutoSet Button for 5 seconds then release.

Your CatGenie stays on the Cat Activation mode you selected until you change it.

To **CHANGE** or **DE-ACTIVATE** any Cat Activation Mode: Press & Release the Auto Set Button until the LEDs go out.
Both 14 & 24 hour Cat Activation options double the number of SaniSolution Cartridge washes from 120 to 240.

If another cat uses the CatGenie during a Delay, the unit adjusts to allow more wait-time before starting.

TIP: Make sure your cats are using their CatGenie before setting Cat Activation.

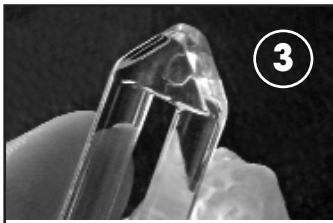

Your CatGenie needs only 10 seconds of maintenance every 3 months...

To keep running properly and efficiently, every appliance requires a little maintenance.
The CatGenie has a Water Sensor Guide that needs cleaning every 3 months.

The Water Sensor Guide is a 4" double bar of clear plastic located under **1)** the Processing Unit. Lift the Unit, **2)** see the ends of the Guide, pull it out and **3)** wipe its triangular tip with your fingers or a damp towel until shiny. See page 16 of the Owners Manual for full details.

TIP: Cleaning the Guide takes no time and saves trouble. A dirty Guide sends a false signal, which causes the CatGenie to go into a safety mode that won't allow it to fill with water. This means it won't clean until you clean the Water Sensor Guide.

and if you don't take care of your CatGenie, it warns you until you do.

When you **HEAR** one beep going on & off for 30 seconds every hour **AND** you **SEE** the #1 LED plus the ERROR LED blink together on & off every 3 seconds, you know you better clean your Water Sensor Guide.

IMPORTANT SAFETY INSTRUCTIONS

To Prevent Risk of Fire, Electric Shock, or Injury to People and Pets.

TO PREVENT FIRE or shock hazard, do NOT expose the CatGenie Processing Unit to rain or sources of splashing water. Do NOT operate the CatGenie with wet hands.

READ ALL INSTRUCTIONS BEFORE INSTALLING AND USING YOUR CATGENIE. USE THE CATGENIE ONLY FOR ITS INTENDED PURPOSE.

All modifications or changes not explicitly described or approved of in this manual could void your Warranty.

WARNING: Basic safety precautions must and should always be followed to reduce the risk of personal injury.

ON SAFETY

Should any solid object fall on or into the Processing Unit or should liquid penetrate the Processing Unit, unplug the CatGenie and have it checked by qualified personnel before using.

Unplug the CatGenie Electric Cord from the outlet before attempting to clear a jam or remove an object from the Hopper's processing area. Do NOT put fingers or hands into the Hopper opening while the CatGenie is operating.

ON POWER SOURCES

Before operating the CatGenie, check that your local power supply is identical to the CatGenie operating voltage, which is 120VAC. See complete specifications in Gray Box on right.

UNPLUG the CatGenie FROM ITS ELECTRIC OUTLET before cleaning the Processing Unit or washing any other CatGenie parts.

NOTE: When you remove the Processing Unit from its Base, current is still going to it, so unplug the Genie Electric Cord first.

If you are not going to use the CatGenie for an extended period of time, disconnect the CatGenie from the electric outlet.

When disconnecting the CatGenie electric power cord, pull the PLUG. NEVER pull the cord. A damaged or defective AC power cord should be changed at a qualified service shop.

ON PLACEMENT

Position the CatGenie in a place with adequate ventilation to prevent heat build-up and to prolong the life of the CatGenie.

Do NOT place CatGenie near heat sources, or in a place subject to direct sunlight, excessive dust, or mechanical shock.

Do NOT place anything on top of or behind the unit.

This may block ventilation holes and cause malfunction.

Do NOT install or store the CatGenie where it could be exposed to rain or splashing water.

See the Simple Setup Guide for site selection options.

ON OPERATION

Before connecting the CatGenie to the power source, be sure to read this manual. NEVER, under any circumstances, connect the CatGenie to a power source unless the CatGenie Processing Unit is properly seated and secure in its slot in the Base.

Do NOT operate CatGenie with wet hands. Follow all instructions and warnings in all CatGenie Manuals.

ON CLEANING

Clean the Processing Unit and Control Panel only with a soft damp cloth slightly moistened with water. NEVER immerse it in or spray it with water.

Do NOT use any type of abrasive pad, scouring powder or solvent such as alcohol or benzene. See Cleaning the CatGenie on page 16 for further instructions.

If you have any questions or problems concerning your CatGenie, please contact our technical support staff at: 1-888-735-3927

PetNovations, Inc. cannot assume responsibility for any and all possible damage if CatGenie is inappropriately operated or used for a purpose other than that for which it is intended.

While PetNovations, Inc. reserves the right to change design and specifications without notice, we do alert our customers about upgrades and product improvements.

To receive news of upgrades, improvements, and special offers, register your Warranty at... catGenie.com

CatGenie SPECIFICATIONS for NORTH AMERICA

- **Power Requirements:** 120VAC, 60Hz (15A Fused)
- **Power Consumption:** 20W (Cleaning Cycle-17Minutes) 1200W (Drying Cycle-17 Minutes)
- **Approximate Weight:** Total CatGenie: 25 lbs. (Includes Processing Unit, 11 lbs. Base Unit, 14 lbs)
- **Supplied Accessories:** Utility or Laundry Room T-Adapter, Bathroom or Powder Room T-Adapter, SaniSolution Cartridge, and Washable Granules.

My
CatGenie
Serial Number _____
Serial Number is on the back of the Processing Unit.



CUSTOMER SUPPORT

Please call or email Customer Support if you see visible damage to your CatGenie or if you have cat adjustment problems. We are happy to assist you with ANY question or issue that you may have concerning your CatGenie.

Call: 1-888-SELF-WASH • 1-888-735-3927

Email: support@CatGenie.com

Visit: www.CatGenie.com

How do I mute
warning beeps?

**Press & Release
the Start/Pause Button.**



CatGenie QUICK FIX

Many problems are caused by the following. Check & Correct.

- 1.** Make sure that your cold water supply is turned on and that the knob is turned on all the way.
- 2.** Check electric power. Plug in electric cord. Check that the Processing Unit is correctly placed in its slot.
- 3.** Clean the Water Sensor. Remove the Processing Unit. Pull out Water Sensor, clean its tip, replace. **See page 16**
- 4.** Clear Hopper. Unplug electric. Remove Hopper Cover. Remove obstruction. Replace cover. Plug in. **See page 16**
- 5.** Straighten bent or crimped CatGenie water supply and drain hoses.

TROUBLE SHOOTING

See Pages 12, 13, 14, 15

120 OWNER'S GUIDE TABLE OF CONTENTS

Safety Instructions.....	2
CatGenie Specifications.....	2
Customer Support.....	3
QUICK FIXES.....	3
CATGENIE ANATOMY	4-5
CatGenie FAQs.....	5
CONTROL PANEL	6
• Program Cat Activation.....	7
• Program Auto Start	7
• Program Child Lock.....	8
SUPPLIES	8-9
• Washable Granules.....	9
• SaniSolution	9
CATGENIE SETUPS	10
• Bath & Laundry Rooms.....	10
• Correct Setup Examples.....	10
• Spare Parts.....	11
TROUBLE SHOOTING	12-15
• Errors 1, 2, 3, 4 Beeps & Lights	12-13
• Errors without Warnings.....	14-15
CATGENIE MAINTENANCE	16
• Machine Cleaners	16
• How to Clean the Water Sensor.....	16
• Clear Clogs.....	17-18
• Technical Modes.....	19
FCC Notice & Warning.....	20
90-Day, Money-Back Guarantee.....	20
2-Year Warranty.....	20

ANATOMY OF THE CATGENIE 120

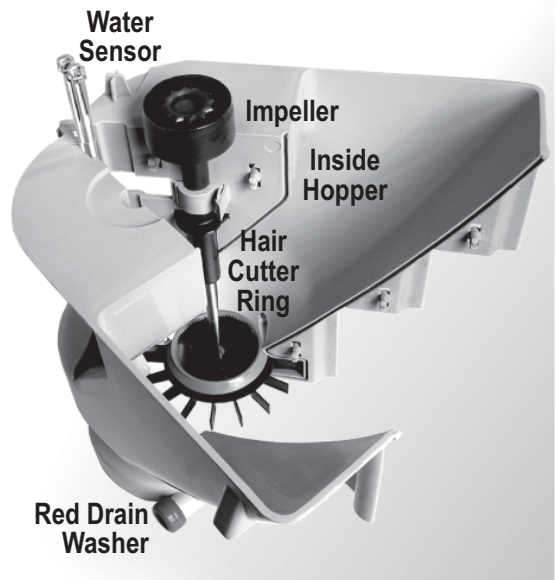
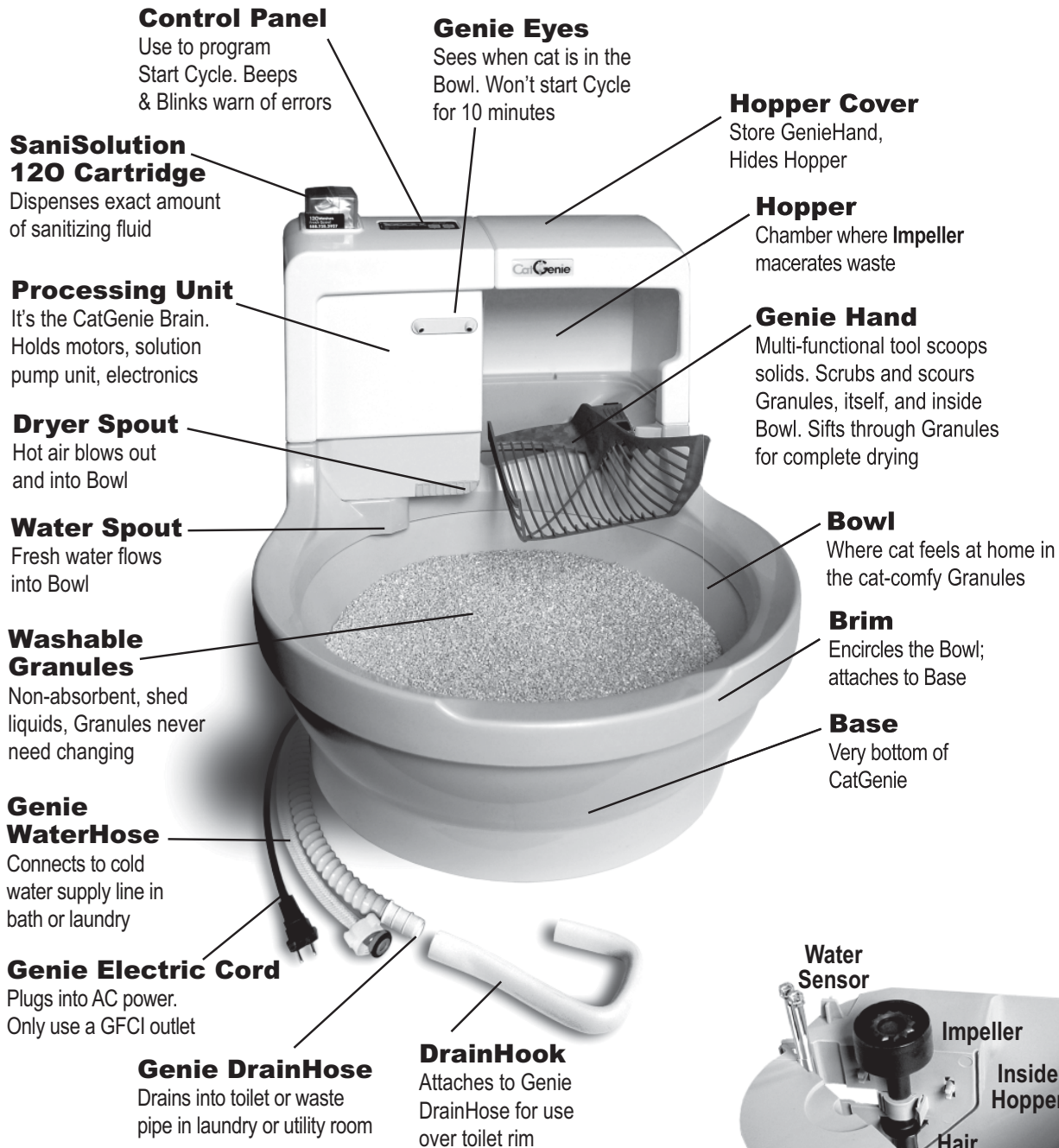

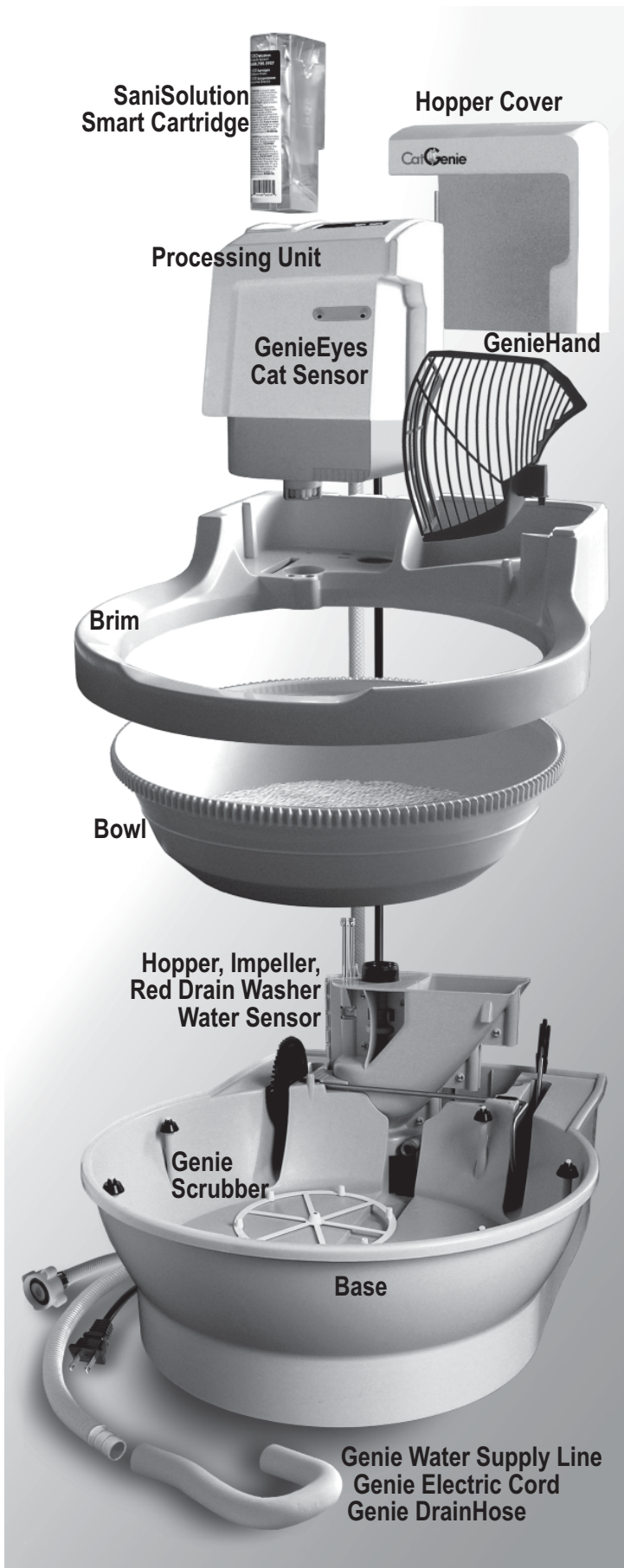

CATGENIE FAQs

IS THE SANISOLUTION CLEANER SAFE FOR MY CAT?

Yes, SaniSolution is safe for cats. Its ingredients are like those used by veterinarians to disinfect their operating areas. Liquid in the Cartridge is highly concentrated. In this form, it is safe as long as it is in the Cartridge.

HOW LONG DOES THE SANISOLUTION LAST?

On Cat Activation, one SaniSolution Cartridge is good for 240 washes. On Auto Set, one is good for 120 Cycles. ALWAYS keep extra Cartridges on hand. The price of SaniSolution equals the yearly cost of cat litter, yet it's just a fraction of the size and weight of litter.

DOES THE SANISOLUTION DISSOLVE OR LIQUEFY SOLIDS?

No. The solids are turned into wastewater by the action of the Impeller, which is inside the Hopper. The SaniSolution washes and disinfects the Washable Granules, GenieHand, and Bowl.

CAN I REFILL THE SANISOLUTION SMART CARTRIDGE?

No, the Cartridge cannot be refilled. The Smart Cartridge's unique mechanism dispenses the exact amount of solution used for each of the 3 washes per Cleaning Cycle, as each wash requires a different quantity. The SaniSolution washes away odor-causing materials, aids in drying, and protects the CatGenie mechanism. The exclusive SaniSolution formula was tested and approved by veterinarians for cat safety.

IS THE CATGENIE GREEN?

The SaniSolution Smart Cartridge replaces the use and need for cat litter. Unlike any type of litter, the SaniSolution, the Cartridge, and the Washable Granules are environmentally safe, biodegradable and/or recyclable.

WHAT HAPPENS IF MY CAT IS IN BOWL DURING CLEANING?

The CatGenie has sensors, GenieEyes, which delay the cleaning cycle until your cat is safely out of the CatGenie.

WILL MY WATER BILL INCREASE BY USING THE CATGENIE?

Your water bill should not have any significant increase. Running a CatGenie is equal to a few additional toilet flushes per day.

WHERE DOES WASTEWATER GO WHEN IT LEAVES THE UNIT?

Wastewater drains safely out of your home into sewer pipes. When used in a bathroom, the GenieHose hooks over the toilet rim; waste drains into toilet. When used in a laundry, waste goes into the Washer's drain pipe.

IN A LAUNDRY ROOM, COULD WASTE WATER GET ON CLOTHES?

No. When properly hooked into the washing machine drain pipe, waste water can not touch laundry. The drainpipe connects directly into sewer or septic tank. **NOTE: the length of the washer's drain hose inside its waste pipe must be less than 5 inches.**

IN A BATHROOM, CAN THE TOILET BE USED DURING A CYCLE?

Yes. The CatGenie does not interfere with toilet use. Toilet seats have feet (check yours) so the DrainHose Hook can not be crushed.

CAN A TOILET OVERFLOW WHEN WASTE WATER GOES INTO IT?

No. Water in a toilet automatically lowers to its preset level and will not overflow unless your toilet is clogged.

WHAT HAPPENS IF SOLIDS STICK TO THE GENIEHAND?

During all three washings, the GenieHand gets scrubbed clean by the action of water, SaniSolution, and Washable Granules.

DO THE WASHABLE GRANULES™ ABSORB?

No, the cat-safe Washable Granules are completely non-absorbent. Unlike traditional litter, the Washable Granules are thoroughly washed each cleaning cycle. Their function is to fulfill your cat's need to dig and cover.

WHAT HAPPENS IF WASHABLE GRANULES ARE SWALLOWED?

The Granules are non-toxic for both cats and humans and can easily pass through their respective digestive systems.

CONTROL PANEL

Your CatGenie communicates with BEEPS & BLINKS.

1 AUTO SETUP BUTTON
Use to Program
CAT ACTIVATION OR to Pre Set
• TIMES of day you want to clean
• NUMBER of cleans per day.

2 START-PAUSE BUTTON
Press & Release to
• Manually START a Cycle
• PAUSE a Cycle,
• RESTART a paused Cycle
• Mute Warning Beeps

3 CHILD LOCK LED & BUTTONS
Prevent accidental starts. **Press and Hold both BUTTONS** for 3 seconds until Child Lock LED lights. That LED stays lit while in Child Lock mode.

4 ERROR LED
Error LED Blinks and unit Beeps when you have a Cleaning Cycle problem. Beeps sound Error Number. See LEDs 1 through 4 for which Error. Go to Trouble Shooting **page 12** to correct.

5 LEDS 1 THRU 4 & CAT
perform 3 functions:
READ CARTRIDGE LEVEL CHECK
LEDs light under the 10+ to 100+ panel.
SHOW DAILY CYCLES
LED lights the number of Cycles pre-set for daily auto start.
IDENTIFY ERROR
LED 1, 2, 3, or 4 light. Lit LED tells you which Error.

6 CARTRIDGE LED INDICATOR
Lights when Cartridge has 10 Cycles left. Stays lit until Cartridge is empty and replaced. Blinks if non-empty Cartridge is removed.

7 CARTRIDGE LEVEL CHECK LEDS & BUTTONS
Tell how many wash cycles remain. **Press and Release both BUTTONS.**
LEDs light under the 10+ to 100+ panel.

CARTRIDGE low/empty
10+ 25+ 50+ 75+ 100+

CARTRIDGE level check
1 2 3 4 CAT

ERROR

CHILD LOCK (hold 3 sec)

AUTO SETUP

START PAUSE

CUSTOMIZE THE RUNNING of YOUR CATGENIE 120

You have 3 Freedoms of Choice

Cat Start

In Cat Activation mode, CatGenie cleans after your cats use it. So your CatGenie never has a chance to get dirty, smelly, or full of germs. It's the most efficient setting because the 120 Cartridge adjusts the doses of SaniSolution to 240. It's like having two Cartridges in one. Tests prove that in Cat Activation mode, the CatGenie runs 10 times more efficiently.



Auto Start

Allows you to run the CatGenie from 1 to 4 times a day depending on the number of cats. Runs every 24, 12, 8, or 6 hours per day depending on whether you program your CatGenie to run 1, 2, 3, or 4 times a day. Cartridge on this setting dispenses 120 doses of SaniSolution.



Push Start

Push the start button anytime you want to clean the CatGenie. This is handy as an addition to other start options. Use this option when CatGenie is in Sleep Mode or between Auto Start Cycles. Makes checking for health issues easier. Cartridge dispenses 120 doses of SaniSolution.



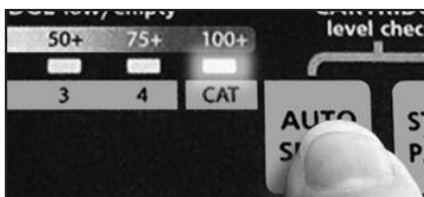

ABOUT CAT ACTIVATION

With Cat Activation, the CatGenie cleans 10 minutes after your cat does his business. If another cat needs to use the potty, the Unit resets and delays for another 10 minutes, etc. The Unit will not start if a cat is using it. The Genie Eyes watch for that.

When set for CatActivation, the Cartridge switches from 120 doses of SaniSolution to 240 doses. Because CatGenie cleans and flushes the mess immediately, it needs less Solution per wash.

Cat Activation uses two modes: 14 hours of **Active Mode** and 10 hours of **Sleep Mode**. In Active Mode, the Unit cleans after cats use it. While in Sleep Mode, the Unit does not run. However you can choose to press the Start Button to clean anytime during those 10 hours. When CatGenie wakes up, it automatically cleans itself if any cat used it while it was sleeping.

HOW TO PROGRAM CAT ACTIVATION.

STEP 1. Decide when you want the CatGenie to wake up from its 10-hour sleep. That's the perfect time to do the following.

STEP 2. Press & Release the Auto setup Button until the "CAT" LED lights up.

STEP 3. Firmly **PRESS & HOLD** the Auto Setup Button for **4 seconds**, then Release.

CAT LED. Once set, your CatGenie responds with 3 Beeps and the CAT LED flashes on. The Cat LED stays on as long as you have Cat Activation in Active Mode. The CAT LED blinks fast for the 10 minute wait after cats use. In Sleep Mode, the Cat LED repeatedly blinks on and OFF to indicate that the Unit is sleeping.

To DE-ACTIVATE: Press & Release the Auto Setup Button until CAT LED goes out.

See Page 8 for info on **PAUSING a CLEANING CYCLE** and about **POWER FAILURES**

HOW OFTEN SHOULD I RUN MY CATGENIE ON AUTO SET?

One Cat..... Clean 2 times per day
Two Cats..... Clean 4 times per day
Three Cats..... Clean 6 times per day

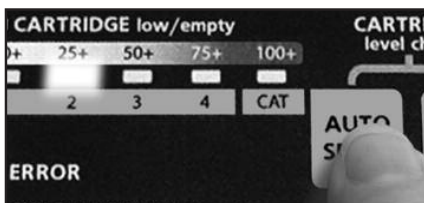

SHORT CUTS

Saves You a Setup Step

• **Want to add more daily washes?**

Just Press & Release the Auto Setup Button at any time until the number of cycles that you want lights.

• **Want fewer daily washes?** Press & Release Auto Setup until all LEDs go out. Then Press & Release Auto Setup until your number of Cycles lights.

• **Want to just change the wash time?**

At the new time, Press & Hold Auto Setup for 4 seconds then Release.

ABOUT AUTO START

With Auto Start, you preset the CatGenie to clean from 1 to 4 times during a 24 hour period. Once programmed, the Unit automatically STARTS at the pre-set Cleaning Cycle times.

Because Auto Start runs on a timer, you would program your Auto Start Setup at one of the times that you actually want your CatGenie to start a Cleaning Cycle. **For example**, if you want your CatGenie to run at 2 am and 2 pm, you must program Auto Setup at either 2 am or 2 pm. If using Auto Start, it is important to follow the chart at left and to observe when your cats do their business so as to coordinate cleaning times.

HOW TO PROGRAM AUTO START SETUP.

STEP 1. Decide how many times a day and what times of day that you want your CatGenie to clean. Pick a time and do the following.

STEP 2. To set the NUMBER of auto-timer washes (one to four) per day, Press & Release the Auto Setup Button for **EACH** number of Cleaning Cycles that you want to run every day. For once a day, Press & Release once. For twice a day, Press & Release twice. For three times a day, Press & Release three times, etc. **DON'T HOLD** the button down.

A Daily Cycle LED lights for the each number of times set. One LED lights for once a day.

Two LEDs light for twice a day. Three LEDs light for three a day, etc. **IF YOU MAKE A MISTAKE**, Press & Release the Auto Setup Button until all LEDs go out, then **repeat Step 1**.

STEP 3. To set the TIMES that you want the CatGenie to run auto timer washes, **firmly PRESS & HOLD** the Auto Setup Button for **4 seconds**, then Release. CatGenie responds with 3 Beeps while 4 Daily Cycles LEDs flash on and off, and then go out. The number of washes you set stays lit. Once Auto is programmed, the CatGenie starts a cycle in 30 seconds.

CAUTION: It is important to run your CatGenie one to two times a day per cat. Not running your CatGenie enough can cause clogs. Best to run a wash cycle soon after your cats go. Don't let solids accumulate and harden.

AUTO SETUP TIME EXAMPLES.

If you want it to run once a day at 8:15am... program it at 8:15am

3 times a day at 6am, 2pm, 10pm... program at any of those times

4 times at 7am, 1pm, 7pm, 1am. Program at any of those 4 times



BRUSHING YOUR CAT HELPS CAT & CATGENIE



GENIE EYES SEE CAT IN BOWL

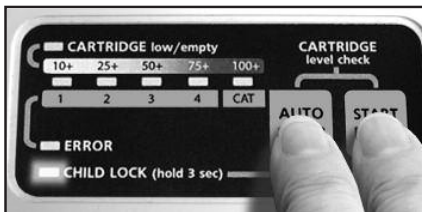

MORE ABOUT AUTO START

What's the best time to run your CatGenie?

Cats usually defecate within half an hour after eating a main meal. Cat experts tell us that cats sleep 15 to 20 hours a day (70% of their day). Keep a schedule of your cat's behavior. Choose running times that won't interfere with your cat's routine.

NOTE: If your cat is using the Bowl at the same time that the CatGenie is set to clean, the GenieEyes Sensor alerts the CatGenie to delay the Cleaning Cycle. After a cat, and any cats that follow, leave the Bowl, the CatGenie waits 10 minutes before starting a Cycle.

HOW to PAUSE a Cleaning Cycle.

- To PAUSE a Cleaning Cycle (Auto or Manually initiated) Press & Release the Start /Pause Button. When in PAUSE, the CatGenie will TICK
- To restart, Press & Release Start /Pause again. If left in PAUSE mode, the Cycle resumes in 10 minutes. While in PAUSE, the CatGenie makes a TICKING sound.

POWER FAILURE ALERT.

CatGenie alerts you when you have a power failure, by interrupting the lit LEDs. So your settings for Cat Activation and Auto Start could be off because the Timer delays start times for as long as the power is out. You can forgo resetting if a brief black out or a quick unplugging occurred, as the Start Time is just a few minutes later. If power is out for several hours and you want to reset, refer to page 6.

MANUAL START OPTION

To START a non-programmed Cleaning Cycle, Press & Release the Start Cycle/Pause Button. Use this option if you want to check your cat's eliminations for health reasons or if it is between running times and you want your CatGenie cleaned.

CHILD LOCK. RECOMMENDED to keep Cats and Kids from starting a wash cycle accidentally.

To Activate Child Lock: Press the Start/Pause Button and the Auto Setup Button at the same time and HOLD for 3 seconds then release. CatGenie Beeps and the Child Lock LED lights to confirm that you have activated the Child Lock feature. The CatGenie Beeps if someone touches a button when Child Lock is active.

To Deactivate Child Lock: Press the Start/Pause and Auto Setup Buttons at the same time and HOLD until Beeps stop and Child Lock LED goes out. Then release.

NOTE: The Child Lock LED lights to confirm that you have activated the Child Lock feature.

SUPPLIES

***MORE EARTH FRIENDLY.
BIODEGRADABLE & RECYCLABLE
WASHABLE GRANULES & CARTRIDGE**
so you won't feel guilty when the Cartridge is empty.

Most plastics take thousands of years to break down and some can never biodegrade! CatGenie Granules and Cartridges have a unique additive that enables plastic-loving bacteria to break down the plastics. The Cartridge Cases biodegrade in less than a decade. The Cartridge plastic can also safely mix with other recycled plastics. Any lost Washable Granules biodegrade within 9 months in Septic Systems and two years in landfills.



CARTRIDGE low/empty				
10+	25+	50+	75+	100+
1	2	3	4	CAT

NEVER remove the Cartridge while CatGenie is cleaning

Removing the Cartridge during a cleaning cycle will NOT extend Cartridge life. Removal causes CatGenie to not clean thoroughly, not dry completely, and not destroy bacteria and odors effectively. Removal before a cleaning cycle causes the CatGenie to not run at all.

NOTE: The Cartridge-User Counter registers usage at the start of each cycle.



WASHABLE GRANULES never need changing.

While the Washable Granules never need changing, they do need to be replenished. Just add Granules when the amount falls below the fill-level line, which is indicated by an indentation inside the Bowl. It is important to keep the Granules filled to that level. Always have an extra package of Washable Granules on hand.

WARNING: NEVER, under any circumstances, use or mix cat litter with the Washable Granules in your CatGenie. Doing so can cause severe damage to your CatGenie and will void your Warranty. Just a few grains of clumping litter clogs pipes, ruins the Water Sensor, and causes endless errors.

SANISOLUTION 120 CARTRIDGE

is the key to CatGenie operations and cat protection.

The 120 Cartridge keeps the concentrated SaniSolution liquid safely contained. Its software program accurately dispenses, monitors, and controls the proportion of Solution to water for the maximum safety of your cats and the optimal operation of your CatGenie. When empty, replace the 120 Cartridge or your CatGenie won't function. Always have extra 120 Cartridges on hand, so your CatGenie can work without interruption.

WARNING: ONLY USE THE TRANSLUCENT SILVER, CatGenie SANISOLUTION CARTRIDGES in your CatGenie 120 MODEL. Do NOT buy or use any with brass bars.

CHECK NUMBER of WASHES in CARTRIDGE.

NOTE: If CHILD LOCK is on, turn off by Pressing the Start and Auto Buttons at the same time. HOLD until Beeps stop and Child Lock LED goes out. Then Release. Now you can check the...

Cartridge Level: Press Start/Pause Button and Auto Setup Buttons at the same time. HOLD for ONE second then release. The LEDs under the 10+ to 100+ panel light up to the nearest number of washes remaining in the Cartridge. You will have 3 seconds to view the read out.

NOTE: If you always use Cat Activation, double the number indicated by level check LEDs.

REMEMBER to reconnect CHILD LOCK. Press Start/Pause Auto Setup Button together. HOLD for 3 seconds then Release.

HEED THE 120 CARTRIDGE WARNINGS.

Low Level: When 10 of the SaniSolution portions remain in the Cartridge, the Cartridge LED lights and stays lit. Check that you have an extra Cartridge or **ORDER IMMEDIATELY.**

Critical Level: When 3 wash cycles remain in the Cartridge, the Cartridge LED lights and a repetitive, One-Beep Warning sounds for 30 seconds once every hour. To stop the Beep, Press & Release the Start/Pause Button. The Cartridge LED stays lit to remind you that only 3 wash portions remain. **TIP:** If you will be away when the Cartridge is scheduled to run out, switch to a full Cartridge until you return. Then switch back to the almost empty Cartridge.

Empty Cartridge: When empty, the Cartridge LED blinks and a repetitive, 2-Beep Warning sounds for 30 seconds once every hour. To mute the Beep, Press & Release the Start/Pause Button. The LED blinks and CatGenie can't do a wash. **If you try to start a Manual Cycle, the 2-Beep Warning reactivates.** Just add a fresh Cartridge and all will be well.

No Cartridge: Cartridge LED and Error LED alternate blinks. CatGenie won't start. Replace to activate. Incorrect Cartridge placement also causes Beeps. Put Cartridge in correctly. The notch goes to the rear. CatGenie needs a correctly placed Cartridge with SaniSolution to work.

ABOUT SANISOLUTION.

SaniSolution is safe and non-toxic for cats and humans when properly used in the CatGenie. Ingredients are same as disinfectants used by veterinarians to sterilize exam and operating areas.

WARNING: In its concentrated state, the Solution may be irritating to skin and eyes, so avoid contact. Do not ingest. Keep out of reach of children. In case of skin or eye contact, wash with copious amounts of water. If swallowed get medical advice or call this emergency number: 1-800-424-9300.

SETUPS. See Simple Setup Guide for Complete Directions.

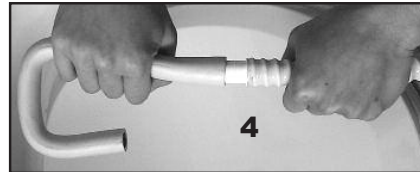
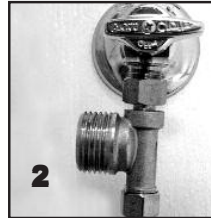

LAUNDRY or UTILITY ROOM

1. Turn off the laundry's cold-water supply valve. **2.** Unscrew your washing machine's cold-water supply hose from its valve. **3.** Attach washer hose to supplied 3/4" T-Adapter, then screw the Adapter onto the cold-water valve. **4.** Screw the Genie Water Line onto the T-Adapter, then turn on cold water. **5.** Put Genie DrainHose into Washer's waste pipe with Washer's drain hook. Don't squeeze hoses. **6.** Avoid clogs and overflow. Washer drain hose must be less than 5" inside waste pipe. Plug power cord into a GFCI electric outlet.

BATH or POWDER ROOM

1. Shut off cold-water line on toilet or sink and unscrew water flex hose. **2.** Attach the 3/8" T-Adapter to flex hose and to cold-water line. **3.** Screw the Genie Water Supply to the T-Adapter. Turn cold water on. Check for leaks or drips. **4. For toilet use only,** connect the Genie Hook to the Genie DrainHose. Push until the white tip on the Hose is all the way into the Hook. **5.** Put the Genie DrainHook over the toilet rim. Plug the Genie power cord into a GFCI electric outlet.

FITTING TWO HOSES INTO ONE LAUNDRY DRAIN:

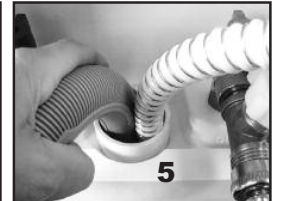
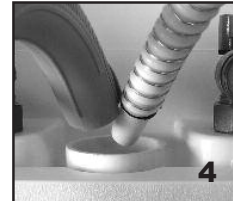
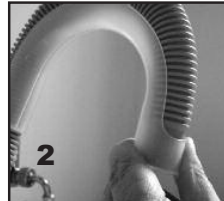

1. If the GenieHose and washer hose won't fit easily into the drain, remove both hoses. Put the GenieHose in first, then add the washer hose. **2.** If the washer hose has a guard, hold the guard and hose tightly together and push washer hose into the drain.

3. If the washer hose with its guard still won't go into the drain, move the washer guard up the hose about 2 inches. Then put the washer hose into the drain.

4. Another option is to put the hoses in together with the GenieHose a little ahead of the edge of the washer hose. **5.** Push both hoses in until they are firmly secured inside the drainpipe.

RIGHT & WRONG SETUPS:



LAUNDRY DRAIN

YES. Do run Genie DrainHose along floor for about 2', and then up to the laundry drain pipe. **NO.** Do not run the Genie DrainHose straight up to the laundry drainpipe.

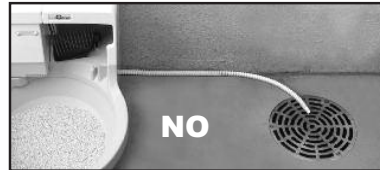

FLOOR DRAIN

YES. Do run DrainHose out and up 12" high, then down along floor to drain. Level CatGenie if floor slopes to drain. **NO.** Do not run DrainHose down on the floor directly to the drain.

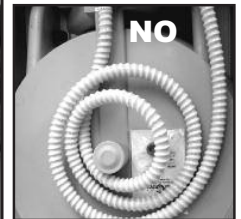

COILING the DRAIN HOSE

YES. Do make wide, uninked coils if you need to store the DrainHose under the Base. Run the hose through the notches in the Base. **NO.** Do not make tight coils or kinks in the Genie Hoses. **NO.** Do not pinch or squeeze Hoses.

HOW TO GET INSIDE YOUR CATGENIE if you need to replace a part.



To take apart your CatGenie, move the CatGenie away from the wall. Keep the DrainHose in the toilet or drainpipe. Take off the Hopper Cover. Remove the Processing Unit and place it upright on a towel on the floor. Lean the Unit securely against the wall. Unclip

the GenieHand. Push Arm and Clip back into the opening. To remove Brim, push on Black Button for leverage as you pull up the Brim back. Put aside. Hopper is accessible for removal if necessary. To get to the Base, remove the Bowl of Granules. Set aside where cats can't use.

WARNING: Unless a Manual instructs otherwise, always unplug the Genie power cord before you work on your CatGenie. Be sure to plug it back in you're finished. Removing the Processing Unit also interrupts power. If working on the Processing Unit, first unplug the power cord.

HOW TO REPLACE PARTS. Spares available under Genie Base. Or from us.



Spare Parts Kit is under the Base. Keep it there until needed.

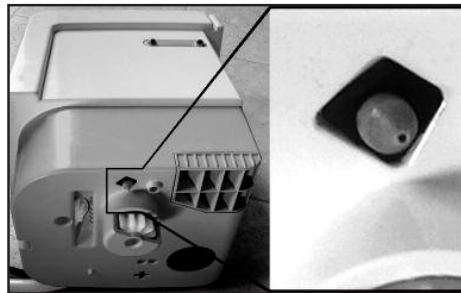

ORANGE NIPILET:

Located at the bottom of the Processing Unit. The Niplet prevents the SaniSolution from drying out and clogging the white dispenser Nozzle to which it is attached. To check if it's OK, unplug CatGenie. Carefully lift the Unit from its slot. To clean Niplet, squeeze out clumped Solution. Then wash with warm water. If missing, get one from Spare Parts.

Put Niplet onto the white Nozzle. Clean Unit slot on the Brim. Wipe bottom of Unit with a soft cloth. Carefully and securely put Unit back into its slot. **Plug in the CatGenie.**

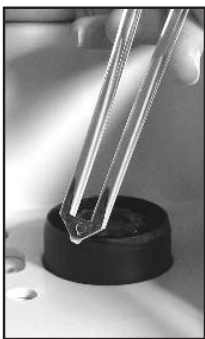

WATER SENSOR:

If the Sensor Tip gets scratched or damaged it won't work. Replace with the extra Sensor in the Spare Parts Kit under the Base.

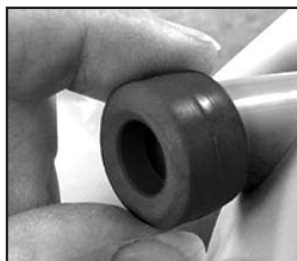

RED WASHER:

Attaches to the bottom of the Hopper and connects to the DrainHose. The Red Washer is a Critical piece. It prevents wastewater leaks. It's important that it is not squeezed or defective. Make sure that it is securely in place on the Hopper. Keep it lubricated with baby oil or liquid soap.



3/4" T-ADAPTER WASHER for LAUNDRY SETUP:

Check if Lock-Nut side of the T-Adapter has its Black Washer. If missing, purchase at a hardware store. Or call us toll free at 1-888-735-3927.

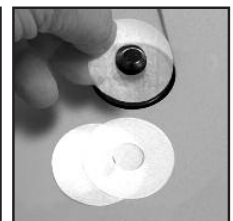

SPACER DISCS:

If you have excessive loss of Granules under the Brim, Spacer Discs are provided in the Spare Parts Kit under the Base. Follow directions.

Add just one Disc to the Knob in the center of the Base, on which the Bowl rotates. Put the CatGenie back together. Before adding the Processing Unit, spin the Bowl to check that Bowl moves easily. Run a Cycle to test that all works.

TROUBLE SHOOTING.

TIP: To avoid 90% of problems, set your CatGenie on Cat Activation.

If you have a 1, 2, 3, or 4 Error, a BEEP sounds the Error number.
The Error LED lights and the number LED lights which Error.
Both lit LEDs alternate blinks.
Example: 2 beeps, #2 LED & Error LED lit, means you have an Error 2.

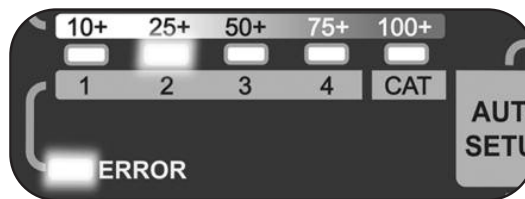

You could also have a problem that is not indicated by an error LED or BEEP.

SEE & LISTEN for WHICH ERROR. OBSERVE SYMPTOMS. Press START to Stop Beeps.

ERROR 1. Hear Beeps, Error LED & LED 1 lit. Dirty Water Sensor or a Clog.

A. WATER SENSOR IS DIRTY or missing. Remove Processing Unit. Pull Water Sensor up from the top of the Hopper. Use a soft cloth to wipe Sensor and Tip. The Tip must be lime free and shine. Carefully replace the Water Sensor securely. If Sensor is missing, find, clean, replace. If lost, get another from Spare Parts bag under the CatGenie Base. Put in place. Gently replace the Processing Unit securely in its slot.

B. WATER IS IN THE HOPPER. Do NOT unplug electric cord or remove Processing Unit. Press Start/Pause Button to silence the BEEP. Follow **Clog Clearing Directions on page 17.**

IF NOTHING WORKS, Call 1-888-735-3927. Report Error 1. Have your Serial #.

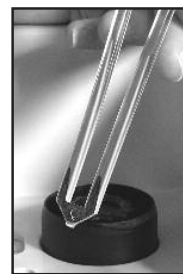

Dirty Tip is Dull



Clean Tip is Shiny

ERROR 2. Hear Beeps, Error LED & LED 2 lit. Cycle Stops; there is a water problem.

A: NO WATER. Don't unplug electric or remove the Processing Unit. Press Start Button to silence Beeps.

- The water supply valve from laundry or bathroom line is turned off. Turn on cold water supply line valve all the way on.
- Genie Water Hose is either not connected to home's water supply or to back of Processing Unit. Connect Genie Water Line to cold-water line or to Processing Unit.
- CatGenie Water Supply Hose is bent or crimped. Loosen coil, un-crimp GenieHose. Once **A** is fixed, Press Start Button for 4 seconds and Release. Cycle should continue.

B. NOT ENOUGH WATER: Don't unplug electric or remove Processing Unit.

- Water drains out as it's filling the Bowl. Raise the Genie DrainHose at least one foot above the GenieBase. Only need a short run. See photo at right.
- Water pressure is low. Do NOT run washer, dishwasher, or shower at the same time as the CatGenie. Water valve should be turned all the way on.
- Sediments in home's water pipe clogged GenieHose filter. Turn off water supply valve. Wait 5 minutes. Unscrew the GenieHose from the T-adapter, and dump Hose water down the Hopper or in a bucket that's lower than the Bowl. Pull CatGenie away from the wall. Unscrew Genie Water Supply line. See the mesh filter. If dirty, remove with a needle-nose pliers and clean. Replace filter. Screw Hose back onto Processing Unit. Screw Hose onto T-adapter, turn on water supply valve. When **B** is fixed, Press the Start/Pause Button for 4 seconds and Release. Cycle should continue.



Do NOT bend or squeeze the Hose

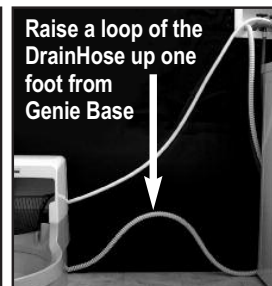

Raise a loop of the DrainHose up one foot from Genie Base



C. TOO MUCH WATER:

- Water Sensor is dirty. Remove Processing Unit. Pull out Water Sensor from top of Hopper. See page 16 for cleaning details. Carefully replace the Water Sensor securely in its slot. Clear off any debris inside the Processing Unit slot before replacing it. Cycle should continue.
- CatGenie is not level. Adjust position or level it with shims. It's OK if right side is higher.
- Lime particles block water holes. Use CatGenie Machine Maintenance Powder or Cartridge for lime removal. One or other included in your package (also at www.catGenie.com). When fixed, Press START for 4 seconds and Release.

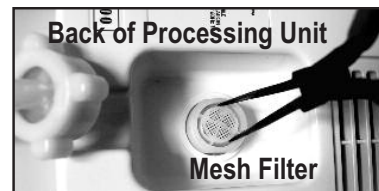

Back of Processing Unit

Mesh Filter

IF NOTHING WORKS, Call 1-888-SELF-WASH (1-888-735-3927). Report Error #2 and symptoms. Have your Serial #.

ERROR 3. Hear Beeps. Error LED & LED 3 lit. Cycle Complete. CatGenie is not draining.

CAUTION: Before fixing, feel whether the Washable Granules are WET, DAMP or DRY. Follow A, if Granules are DRY • Follow B, if Granules are WET or DAMP

A: GRANULES ARE DRY but not washed.

CAUSE: Cycle ran without water because the Water Sensor is crusted with lime.

It reads the lime deposit as if it was water.

Simple Solution: Remove Processing Unit. Pull the Sensor ends up from the top of the Brim. Use a soft cloth soaked in lemon juice or your finger tips to remove the lime. The TIP must shine. Carefully replace the Water Sensor securely into its slot. Then replace the Processing Unit. Press the Start Button to run a special, regular Cycle where the GenieHand goes into a SUPER SHAKE mode to prevent a Granule clog.

B: GRANULES ARE WET or DAMP. Water has not drained from CatGenie.

CAUSE: Could be plumbing setup OR something stopped the draining.

• For complete draining, the Genie DrainHose or Hook must NOT be pinched, squeezed, or tightly bent.

Make sure the Base of the CatGenie is NOT sitting on the DrainHose. Hose should pass through one of the notches in back of the Genie Base.

Part or most DrainHose should be coiled loosely under the Base. No sharp bends!

Add lifts or "feet" to the toilet seat bottom so the seat does NOT squash the Hook. (See Photo).

See page 10 for fitting a Washing Machine Hose and GenieHose into the laundry or utility room drain pipe.

• Make sure that the Genie DrainHose is not too high. Best if the GenieHose drains into a pipe that is no more than 4 feet above the floor. If the drain is higher and you have draining problems, raise the CatGenie.

NEXT STEP: clear the unit of the clog that resulted from a setup situation or from some other source. For example...

- A toy, some other foreign object, or cat hair on the Impeller Shaft could stop draining
- Granules under the Hopper have misaligned Hopper and DrainHose connection
- Granules, dirt, or a small object could be blocking the Hopper Drain Holes
- Hopper's Red Washer is defective, squeezed, missing, or misaligned

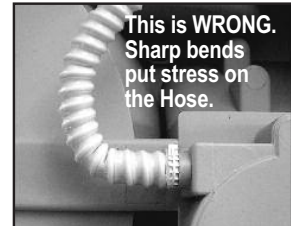

SOLUTION: FOLLOW STEPS ON PAGE 17

SUPER TERRIFIC TIP: Clogging is often caused by not running the CatGenie often enough. Try Cat Activation Mode. CatGenie runs better and extends SaniSolution. See page 7 for programming.

SUPER TIP: To keep your CatGenie running smoothly and to prevent clogs and draining problems, use the CatGenie Machine Maintenance Products 4 to 6 times a year. You received a sample in your CatGenie package. Treatments come in a Maintenance Solution Cartridge or a Powder in a Pouch.

TIP: Call 1-888-SELF-WASH (1-888-735-3927) Report Error #3 and Dry or Wet Granules. CatGenie tech experts can guide you through the correction process. Have your Serial #.

ERROR 4. Hear Beeps. Error LED & LED 4 lit. Dryer Overheats or Stops and Starts.

SOMETHING IS BLOCKING THE REAR VENTS OR FRONT BLOWER. CAUTION. Fire Hazard. Remove anything that blocks air intake vents on back of Processing Unit. Move the CatGenie 2 inches away from wall. Remove obstructions in the Bowl that block dryer's hot airflow. Vacuum rear vents. Let Unit cool for 20 minutes. Press Start Button for 4 seconds. Drying should resume.

CAUTION: Stay with your CatGenie to make sure it's OK. If an Error alerts again, you smell burning, see sparks, or anything abnormal, unplug immediately and contact Customer Service. Call 1-888-SELF-WASH (1-888-735-3927) Report Error #4. Have Serial #.

WATER OR DRAINAGE PROBLEMS. NO ERROR INDICATED.

5. CLEAN WATER is around the Base of the CatGenie. Granules are DRY.

A: TURN OFF Laundry or Bathroom Water Supply Line. Unplug CatGenie. Wait 5 minutes and wipe up the water. Search for the highest wet point for the source of the leak. Tighten all plastic knobs by hand. Tighten all metal-to-metal connections with a wrench. Turn the water back on. If you see a leak, shut off the water, wait 5 minutes, and retighten the connection that drips. Then turn the water back on. If you still have a leak, shut off the water and wait 5 minutes. If this is in a laundry room leak, it could be B.

B: T-adapter's BLACK WASHER is missing. 1. Disconnect the 3/4" T-adapter from the Water Supply Valve. Keep the hoses connected. 2. If Black Washer is missing, purchase a washer at a hardware store.

If nothing works, Call 1-888-SELF-WASH (1-888-735-3927). Report Problem #5. Have your Serial #.



6. WASTE WATER is around the Base of the CatGenie. Granules are DRY.

A. IN LAUNDRY, Genie DrainHose is not placed correctly in drain. See page 10 for placement. **IN BATHROOM, Genie DrainHook is not on toilet rim.** Securely hook it over the rim so it stays put.

B. GENIE DRAINHOSE is bent too tight underneath the CatGenie Base. Lift a CatGenie side to see if water is puddled underneath the Base. Loosen the loop and recoil the Hose. See photo. Go to page 10 for correct Hose coil. Place paper towels under the Base to see if wastewater continues to seep. Remember, it is normal to have some clean water mixed with SaniSolution inside the Base and Hopper. Check if any water leaked underneath before you run another cycle.



If you see wastewater, Call 1-888-SELF-WASH (1-888-735-3927). Report Problem #6 and symptoms. Have your Serial #.

7. GRANULES are WET or DAMP. Cycle is complete. NO ERROR WARNING.

First eliminate clog possibility. See page 17 and follow directions until clog is clear. Then follow all of Page 19 to #6. Call 1-888-SELF-WASH (1-888-735-3927). Test if the drier is running hot, warm, or cold air. CALL if not hot. Have Serial #.

PROBLEMS WITH ASSEMBLY AND NO ERROR INDICATED.

8. GENIEHAND IS NOT SCOOPING at the START of a CYCLE.

Genie Arm moves up & down freely with Processing Unit in place. This is not correct. Remove Processing Unit. Clean off any Granules and debris on Brim or in slot where Unit sits. Hold the Hand tightly and rotate the wheel (see photo) If the wheel turns easily and almost all around, call us. If the wheel barely moves an inch, that is correct. Now wipe away Granules, even under the Processing Unit and put it back into its slot. Check that Hose and Cord are fitted into their slots in back of Unit. NOW, with the Processing Unit in place, test that the Hand still moves freely. If it does, call us. Call 1-888-SELF-WASH (1-888-735-3927). Report Problem #8 and symptoms. Have Serial #.



9. CATGENIE BOWL WON'T ROTATE or only goes in one direction

A. Bowl and/or Processing Unit not seated correctly. Lift Processing Unit out of its slot. See the teeth on the edge of the Bowl exposed through the hole (photo). Use your finger to move Bowl about 1/8 inch so that Bowl Gear can mesh with the Unit's Gear. Clean out any debris or Granules on Brim and in holes. Carefully slide the Processing Unit back into its slot.

B: If you added Spacer Discs, you may have added too many. See page 11 for directions to fix. If rotation problems persist, follow all of Page 19 to #2. And Call 1-888-SELF-WASH (1-888-735-3927) for Service Rep help. Report Problem #9 and symptoms. Have your Serial #.



POWER PROBLEMS: NO ERROR INDICATED

10. YOU PRESS START BUTTON and CatGenie BEEPS/BLINKS and/or WON'T START.

- A. You may have pressed the START/PAUSE BUTTON too fast or too lightly.** Firmly Press the Button again and release. CatGenie answers with a Beep and should start a Cycle. If nothing happens, you may have a power problem. **See #11 below.**
- B. You pressed Start, the Child Lock LED Blinks and Unit Beeps. Unit is in Child Lock Mode.** To De-activate, Press the Start/Pause and Auto Setup Buttons at the same time. HOLD until Beeps stop and LED goes out. Then release. Press Start Button to begin the Cycle.
- C: You pressed Start. Cartridge LED lights; Unit Beeps.** Cartridge missing. Replace. Make sure Cartridge is not empty.
- D. You pressed Start. Error LED and Error Number LED alternate Blinks. Unit Beeps.** Go to **pages 12 or 13** to fix the Error indicated.
- If nothing works, Call 1-888-SELF-WASH (1-888-735-3927). Report Problem #10 and symptoms. Have your Serial #.

11. YOU PRESS START BUTTON and the CYCLE WON'T START.

A. NO ELECTRIC POWER or a circuit breaker has tripped. Make sure the GenieCord is plugged all the way in. Check if home's electric power is on. Plug the CatGenie into a different outlet. Test the CatGenie outlet with another appliance. When the Power is back on, the CatGenie will Beep and then Start.

B. PROCESSING UNIT IS NOT CORRECTLY ALIGNED or seated in its slot on the Brim. Remove Processing Unit. Clean off Granules or debris on Brim or in Unit's slot. Then put the Unit securely back into its slot. Check that Hose and Cord are in slots in back of the Unit.

If nothing works, Call 1-888-SELF-WASH (1-888-735-3927). Report Problem #11.



12. AUTO START NOT RUNNING at programmed times.

- A. CORD UNPLUGGED.** Plug in the Genie Electric Cord. However a power interruption shifts the Auto Set times to later than programmed.
- B. POWER FAILURE or power interruption caused CatGenie to reset.** See **page 7, SHORT CUTS** for reset directions.
- C. DAILY CYCLES NOT correctly programmed.** Check that LEDs are lit to the number of Cycles that you want. **See Page 7** to re-program.
- D. Genie Eyes sense a presence in the Bowl and then delay the Cycle Start.** Keep the area under the GenieEyes clear of objects after you program the Auto Setup or it will postpone the cycle.
- E. IN CAT ACTIVATION, Start Cycle waits 10 minutes after a cat uses the facilities.** It waits another 10 minutes for each cat. If it's set correctly, the Cat LED would be steady on. If not, go to page 7 to re-program Cat Activation. After it's set, wave your hand under the Eyes. The LEDs should blink rapidly. Now keep the area clear for the next 10 minutes. The CatGenie should then start.



If you still have an Auto Start issue, Call 1-888-SELF-WASH (1-888-735-3927). Report Problem #12 and symptoms. Have your Serial #.

13. CYCLE INTERRUPTED, water in Bowl, wet or damp Granules, GenieHand is down.

A. NO ELECTRIC POWER. Power was interrupted; GFCI outlet or a circuit breaker was tripped. Make sure power is restored. Plug in CatGenie cord. If Cycle does not resume, check circuit breaker operation. If Cycle still does NOT continue, test outlet with another appliance. Test GenieCord in another outlet. Cycle should resume. **If not, it's B:**

B. CATGENIE HAS A CLOG. See Clog Clearing Directions on page 17. Follow each step until clog is gone.

If nothing works, Call 1-888-SELF-WASH (1-888-735-3927). Report Problem #13 and symptoms. Have your Serial #.



14. AFTER PRESSING PAUSE TO STOP A CYCLE... **A:** the CatGenie RESTARTED by itself OR **B:** the CatGenie did NOT START after the 10 minute Pause mode.

A: PAUSE MODE is automatically cancelled after 10 minutes. Then the CatGenie cleaning cycle resumes. This is a normal function. The Pause feature turns the CatGenie back on so you don't have to remember to do it.

B: TERMINATION MODE. You may have accidentally stayed pressed on the Pause button for too many seconds. More than 4 seconds on the Pause Button and the CatGenie goes into Termination Mode. **To resume a Cycle press Start/Pause Button.**

CATGENIE MAINTENANCE

To keep your CatGenie running smoothly and to prevent problems like those seen on pages 12 through 15, and on 17 and 18, take these simple precautions.

TIP: RUN ON CAT ACTIVATION
Tests prove that CatGenie performs 10 times better on it than other settings and requires less maintenance. See Page 7 for setting.

A. PUSH BUTTON MAINTENANCE



How easy is this? Pop in the Machine Maintenance Cartridge. Press the Start button and get a super clean, lime & grime free CatGenie in places that you can't readily reach. Result, extra clean, odor free, germ free deep inside your cat's bathroom. Ahhh, peace of mind with a touch of a button. And a touch you do only four times a year. Also available in Powder form in a Pouch. You have received a sample of one or the other in your CatGenie package. Follow directions on the Cartridge or Pouch.

NOTE: By using the Maintenance Cleaners faithfully, you can skip Step B.

B. CLEAN WATER SENSOR or do A and you'll never have to do B

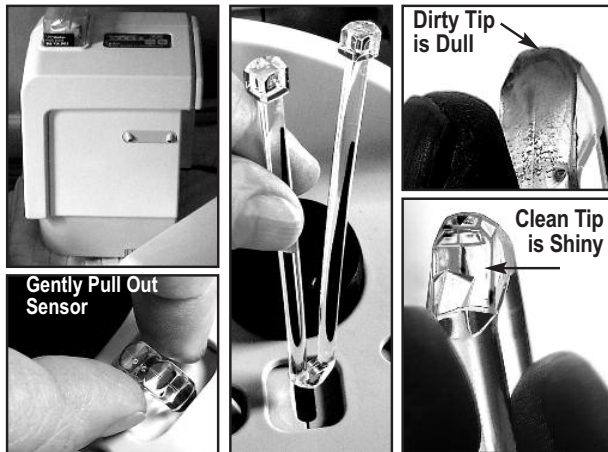

The Water Sensor TIP must be kept free of lime and mineral build up.

If you have hard water, it is important to clean it periodically. (Once every 3 months.) You can use the Maintenance Solutions (available at catGenie.com) or do the following simple procedure. Keep power plugged and hoses in place.

Remove the Hopper Cover and pull the Processing Unit up and out of its slot. Rest the Unit on a towel on the floor and lean it against the wall.

Grasp the Water Sensor Ends and gently pull up and out of the Base.

Have a towel soaked in lemon juice and/or use your finger to remove any lime deposits and to make the TIP sparkle. Carefully slip the Sensor back into its slot.

Lower the GenieHand Check inside the Hopper. Remove fur and foreign objects Before replacing the Unit, wipe away any Granules or debris off the Brim.

Raise the GenieHand to upright position. Place the Unit back into its slot. It Beeps & Blinks. Your done. If it doesn't, check if plugged in. Make sure the P-Unit is securely placed. Check that the hose and cord are in their groves.

C. CHECK HOPPER to see what your cat dragged in.



Keep Hopper clear of cat hair, toys, and foreign objects like coins.

If your cats have long or fuzzy fur, and/or your cats eat plastic, thread, string, or rug fabric, it's important that you check the inside of the Hopper on occasion. These things can cause clogs. Sometimes cats (and kids) drop objects into the Bowl, which can get scooped into the Hopper. Toys, stuffed animals, coins, stones, all kinds of things have been found in Hoppers.

Remove the Hopper Cover. Look inside Hopper. If you see fur or something that doesn't belong, remove the Processing Unit. Move the GenieHand down. Clear out the Hopper and clean the Water Sensor. **See B, above.** Push Hand back up. Wipe off the Brim and bottom of the Processing Unit. Then put the Unit carefully back in its place. It should Beep & Blink. If it doesn't, check if the power cord is plugged in. Make sure that the Processing Unit is securely and completely placed in its slot.

Check the Genie WaterHose and DrainHose. Make sure they are not crimped, crushed, or coiled too tightly. Correct to prevent clogs.

Finally, we recommend that you run a Cycle to make sure that the assembly is correct.

2 STEPS to CLEAR a CLOG

Start with STEP 1. If not successful, go to STEP 2, page 18.
Or please call our service reps in Pennsylvania who will happily guide you to success.

Need Professional Help? Call us at
888-735-3927
Have your serial #
ET 9a-11p WD
10 a-7p WE

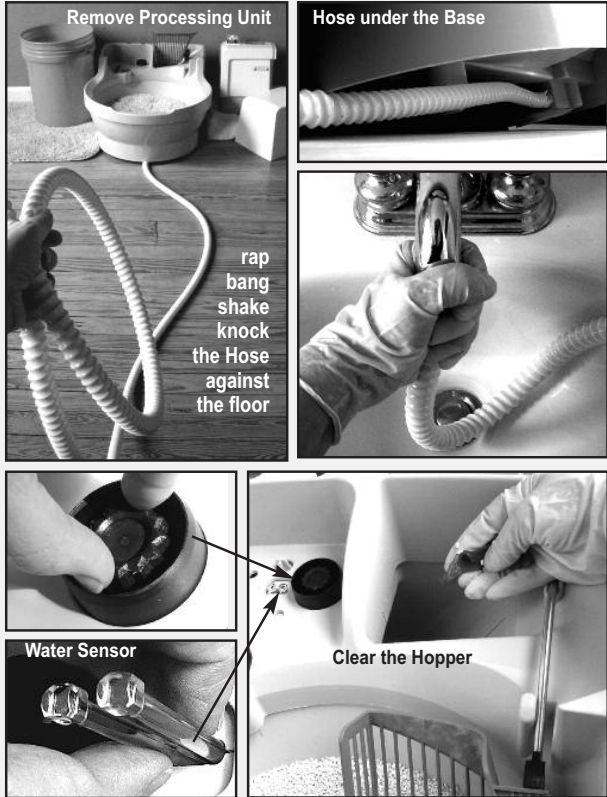

STEP 1

A. Remove Hopper Cover. Pull the Processing Unit up and out of its slot. Rest it upright on a towel against the wall. Now uncoil the DrainHose from under the Base. You could have water in it so be careful. Lift one side of the Base up no more than 2". Run the Hose out the front of Base as shown in photo.

B: In the bath, take the DrainHook off the Hose. **In the laundry,** take the DrainHose out of the drainpipe. Hold the Hose tip. Shake and bang the Hose on the floor towards the Base. This could loosen the clog and force it back into the Hopper for more processing.

C: Cleaning Hook & Hose. Using your hand, clamp the end of the Hose tightly onto the faucet as shown. Turn on water for 5 seconds. Water pressure should force the clog back into the Hopper. Also massage the Hook and run water through it. Reconnect Hook to Hose, return to toilet rim, and keep seat up. Put Hose into drainpipe. Don't squeeze with washer hose. Do nothing to restrict water flow.

D: The Black Knob on the Brim is the top of the Impeller, which grinds solids. Rotate its center knob clockwise 5 times. It should turn easily. Right next to the Knob find the **Water Sensor**. Pull it out and wipe its Tip clean. (See page 16.) **Check the Hopper.** Lower the GenieHand. In the Hopper, remove any foreign objects or cat hair wrapped around the Impeller shaft. **Replace the Processing Unit into its slot.** It should Beep and Blink. If not, check if it's plugged in or if the Processing Unit is correctly seated in its slot.

E: Follow CLOG-CLEAR MODE & DRAIN TEST below.

F. CLOG-CLEAR MODE:

- Lift the Processing Unit out of its slot, count to 3 and carefully put Unit back.
- During **1st** series of Beeps & Blinks, immediately press and HOLD the Start & Auto Buttons at the same time. Beeps & Blinks stop; but keep pressing.
- Then when a **2nd** series of Beeps & Blinks activate, release both Buttons.
- The **3rd** series of Beeps & Blinks means you're in Clog-Clear Mode.
- The #1 LED stays lit. You're now ready to proceed to the Drain Test.

G. DRAIN TEST:

- First Press & Release Auto Button. The **#2 LED lights & 2 Beeps sound.**
- Then Press Auto Button **3** more times until the **#1 and #4 LEDs** are on. Stop.
- Press & Release Start to operate drain pump. **CAT LED** lights; 1 Beep sounds. Watch for water draining out from the end of Hose in toilet or drainpipe.
- If water **DOES drain** from the Hose for at least 1 minute, the clog is cleared. Congratulations. Press the Start Button. Drain shuts and water stops. Proceed to **Back to Normal** at right.

H. BACK to NORMAL:

- Reassemble your CatGenie. Coil the Hose under Base, see photo.
- Press the Auto Button 2 times so now you have **#4 LED and #3 LED** lit. Make sure you have a working Cartridge placed correctly in the slot.
- Press Start. 3 long Beeps and all numbered LEDs light. This means the CatGenie has initiated a special correction cycle.
- Granules are wet, so the Genie-Hand won't initially scoop. Then the CatGenie washes, drains, and dries. And finishes back to normal.



• If water does NOT drain, press Start to shut it off. Repeat **STEP 1**, from A to G. Repeat 3 times; stop if clog clears. If still not draining after 3 times go to **Page 18, Step 2.**



BEFORE TAKING STEP 2, take your CatGenie apart.

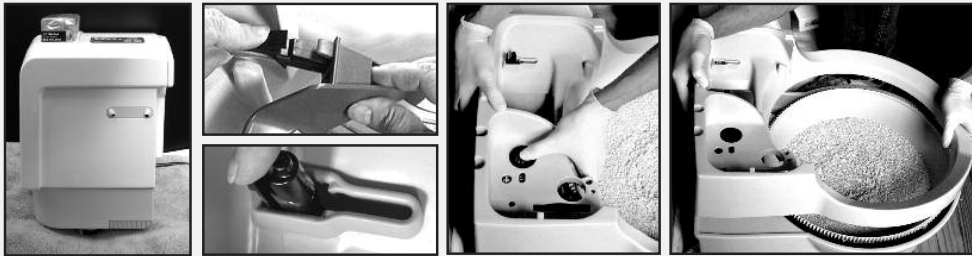

- 1) Remove Hopper Cover and Processing Unit. Rest Unit on a towel. Lean it against a wall.
- 2) Unclip the GenieHand.
- 3) Push its Clip through the Brim.
- 4) Remove Brim by pushing on Knob for leverage. Pull up back
- 5) to release Brim from Base.

STEP 2. CLEAN THE HOPPER INSIDE & OUT...

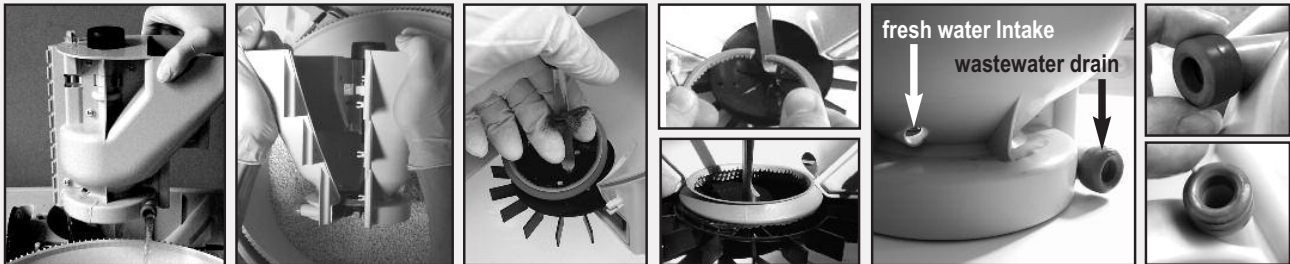

TIP: This part is messy. Wear gloves.

Pull out Hopper. If dirty or filled with water open the Hopper above the Bowl, then put it in or on a bucket or on newspapers. Clean out any hair or debris around the Impeller. Be careful not to lose the HairCutting Ring and the Red Washer. In a sink or tub, thoroughly wash the Hopper.

Remove all Granules from every nook and cranny inside and out and around the Hopper. Replace HairCutting ring, teeth down, on ridge inside the Hopper. Close the cleaned Hopper. Wash the Red Washer. Dab with liquid soap or baby oil. **Proceed to Base cleaning.**

CLEAN INSIDE THE BASE. A dirty job that maintenance prevents.



Remove Bowl. If the Bowl is filled with wet Granules, place it in a trash bag to avoid leaks. Close bag to prevent cats from using the Granules. Remove GenieScrubber from Base. Dump the dirty water from the Base. Be careful. Keep the DrainHose in the drainpipe or toilet. If you have to move the Base in order to dump the water, remove the DrainHose and hold it above (higher than) the Base to avoid leaks. Once the Base is empty, **REPEAT STEP 1 parts B and C on page 17.**

CLEAN THE BASE. Clean/wash out all Granules from all parts of the Base, especially the Slot where the Hopper sits and the hole into the DrainHose. Once all is cleaned and cleared, coil the Hose under the Base as shown in photo to avoid clogs.

ASSEMBLE THE CATGENIE: Put the Drain Hose in toilet or drainpipe. Add the Hopper now, so you can see that the Red Washer is in place. Put GenieScrubber, feet up, into the Base. Replace the Bowl, make sure it is centered and rotates. Now add the Brim and the GenieHand in its up position. Before replacing, check the bottom of the Processing Unit for orange niplet. **RETURN TO PAGE 17. FOLLOW F and H.**

REMEMBER, you can always call us for help. 1-888-735-3927. Have your Serial #



If you can't clean the Base at this time, OR it's not possible for you to dump the dirty water, go to page 17. Repeat STEP 1 parts B and C. Then return here, page 18, to **ASSEMBLE THE CATGENIE**, see just above and follow those steps. Because the dirty water was not emptied, it will be difficult to replace the Hopper. Push it down, slowly. Once assembled, return to page 17 and follow F and H.

IMPORTANT: This short cut is not the solution. Not following the proscribed cleaning steps will cause a second clog. It is...

MANDATORY that you must Repeat Step 2, page 18, very soon, before running more than 2 regular Cycles. Your chances of having another clog on top of the partially cleared one is almost guaranteed.

CATGENIE TECH Only go here if directed from the Trouble Shooting pages or when on the phone with a Customer Service Representative.

CatGenie Tech has 6 Component Modes, which enable you to check if your CatGenie functions work or not. It also has 2 Test Modes. By pushing the 2 Buttons on the Control Panel as directed, you can easily find what ails your CatGenie. Read before proceeding. If you have any questions or are confused, please call us at 1-888-735-3927. Have your Serial # handy. *(Panel below indicates a #5 Tech Mode)*

A. FIRST ACCESS TECH MODE

- Lift the Processing Unit out of its slot, count to 3 and carefully put it back.
- When you hear a series Beeps and 3 LEDs Blink, immediately press and HOLD Start & Auto Buttons at the same time. Keep holding. Beeps & Blinks stop; but keep holding.
- Then when a 2nd series of Beeps & Blinks activate, release both Buttons.
- A 3rd series of Beeps & Blinks activates telling you that you are in Tech Mode
- The #1 LED stays lit, telling you to proceed to the next step.

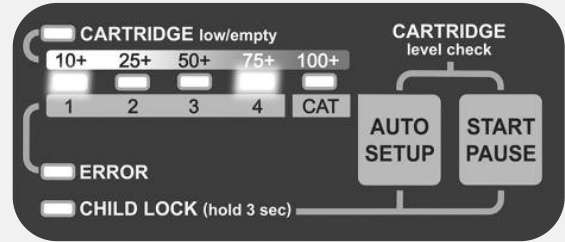

B. NOW ACCESS the individual COMPONENT MODE that relates to your specific problem. In Column One, find Component (1 to 6) that applies and follow the directions across. **NOTE: *** indicates CAUTIONS. **P&R** indicates Press & Release.

CAUTIONS:

- * Pay special attention when operating the Water Valve (fresh water in). If performing correctly, the CatGenie stops filling when water reaches the Water Sensor. If not turned off, (see column 4 press START for OFF) filling resumes as soon as water level drops below the Water Sensor.
- ** You must NOT leave the area while testing the Dryer. It is critical to pay attention while testing. Shut down if you must leave.
- *** Do not over work Components 1 through 6, as they could be damaged. These are only for diagnostic purposes.

CAUTION: Operate column 4, actions 1 through 6, at a maximum of no more than 30 seconds. After testing, make sure everything is OFF.

NOTE: Use the #7 Special Cycle when Granules are wet or damp as a result of poor or no draining from a clog.

TIP: Two LEDs help you navigate column 4 Actions: Cartridge LED indicates UP, ON, or RIGHT. Child Lock LED indicates DOWN, OFF, or LEFT

SHADED AREAS are only to be used with a Service Rep at 1-888-735-3927. Please call if you are unsure about any process.

Mode Navigation, Press & Release the AUTO BUTTON	LED Indications	Testing a Component	To Navigate Between Actions, Press & Release the START BUTTON ***
1. Hand Mode	LED 1	Genie Hand Movement	→ Up → Stop → Down → Stop
2. Bowl Mode	LED 2	Genie Bowl Rotation	→ Right → Stop → Left → Stop
3. Valve Mode	LED 3	Fresh Water Intake *	Off → On
4. Dosage Mode	LED 4	SaniSolution Dosage Function	Off → On
5. Drain Mode	LED 4 + 1	Drain Pump Operation	Off → On
6. Dryer Mode	LED 4 + 2	Heater & Fan Operation **	Off → On
7. Special Cycle	LED 4 + 3	Run for Clogs & Wet Granules	→ Starts Special Cycle & Exits Tech Mode
8. Special Idle	LED 4 + 3 + 1	Special Idle to Test Genie Eyes	→ Starts Special Idle & Exits Tech Mode

C. EXITING CATGENIE TECH

CatGenie Tech (Tech Mode) is active for 30 minutes. After 30 minutes, CatGenie reverts to normal operations mode. If you want to get out of Tech Mode sooner, lift the Processing Unit out of its slot, count to 3 and carefully put it back. When you Activate 7, you get out of Tech Mode.

FCC NOTICE

This equipment has been tested and found to comply with the limits for a Class B digital device, pursuant to Part 15 of the FCC rules. These limits are designed to provide reasonable protection against harmful interferences in a residential installation. This equipment generates, uses and can radiate radio frequency energy and, if not installed and used in accordance with the instructions, may cause harmful interference to radio communications.

However, there is no guarantee that interference will not occur in a particular installation. If this equipment does cause harmful interference to radio or television reception, which can be determined by turning the equipment off and on, the user is encouraged to try to correct the interference by one or more of the following measures:

1. Reorient or relocate the receiving antenna
2. Increase the separation between equipment and receiver
3. Connect the equipment to an outlet on a circuit different from that to which the receiver is connected
4. Consult the dealer or an experienced radio/TV technician.

FCC WARNING

Modifications not expressly approved by the manufacturer could void the user authority to operate the equipment under FCC rules.

USE CONDITIONS

This device complies with Part 15 of the FCC rules. Operation is subjected to the following two conditions:

- (1) this device may not cause harmful interference, and
- (2) this device must accept any interference received, including interference that may cause undesirable operation.

CatGenie UPC Number
891329001256

CONTACT INFORMATION

PetNovations, Inc. USA.

Suite 100

Valley Forge Business Center

705 General Washington Ave.

Norristown, PA 19403

Phone: 1-610-994-2103

Fax: 1-484-654-0154

www.PetNovations.com

90-DAY, MONEY-BACK GUARANTEE

With our 90-Day, Unconditional, Money Back Guarantee you have a total of 90- days from your purchase date for you and your cats to fall in love with the CatGenie® Self-Washing Cat Box. If you're not completely satisfied, return your CatGenie before the 90-day deadline. If you purchased your CatGenie directly from a retail store, return it to the store. (Check with your retailer or on-line store for their individual return policy.) **SAVE THE ORIGINAL PACKAGING.**

If you purchased CatGenie from PetNovations, Inc., **call us at 1-888-735-3927 to receive your Return Authorization Number.** To qualify for the 90-Day, Money- Back, the returned unit must have an RA# . Please clean the CatGenie and throw away used Granules and used Cartridges. Carefully return and send the clean CatGenie in as close to original condition and in its original carton to qualify for a full refund. Please include your reason for return. **Extra supplies that are used or opened are not eligible for refunds.**

2-YEAR WARRANTY

To keep up to date on CatGenie improvements and changes, it is important that you register the serial number of your CatGenie Self-Washing Cat Box. Please use our online warranty form.

LIMITED WARRANTY ONLY FOR PRODUCTS PURCHASED IN U.S.A.

This product has been engineered and crafted with great care for your satisfaction. Please read all instructions before using this product. PetNovations, Inc. warrants this product and all parts thereof, except as set forth below **only to the original purchaser at retail to be free from defective materials and workmanship** from the date of original retail purchase for the period shown below ("The Warranty Period").

A. This two year limited warranty (four year if buyer purchased extended warranty) is valid for the Warranty Period and applies only to replacement of the parts found to be defective in material or workmanship. This warranty does not apply to damage due to misuse, abuse, neglect, alteration or the use of any unauthorized attachment; nor damage caused by use of an electrical circuit not specified on the CatGenie product.

B. If this product is found to be defective, PetNovations, Inc. will replace the defective parts at no charge to the original owner (**and with PROOF of PURCHASE if not bought through PetNovations**). Such replacement services shall be rendered solely by PetNovations, Inc. If any defects should be found in this product, please call PetNovations Customer Service toll free at 1-888-SELF-WASH. A new or remanufactured equivalent part will be shipped directly to you. Once you receive the replacement part, kindly box the defective part, in the replacement box with the prepaid label enclosed and return to PetNovations, Inc. Suite 100, Valley Forge Business Center, 705 General Washington Avenue, Norristown, PA, USA 19403. PetNovations, Inc. will prepay all freight for the replacement item, as well as the return of the defective item in the 48 contiguous states. **This warranty is void and the owner will be charged for the replacement part if the owner repairs or modifies the product in any way or does not return the part if requested. This limited warranty from PetNovations, inc. is valid only in 48 contiguous United States, and District of Columbia. (Not valid in Alaska, Hawaii, or other countries. See B1)**

WARRANTY FOR ALASKA, HAWAII, PUERTO RICO AND CANADA

B1. For Customers outside the 48 contiguous states in Alaska, Hawaii, Puerto Rico and Canada ONLY.

If this product is found to be defective, PetNovations, Inc. will replace the defective product parts less freight and duty to the original owner (**and with PROOF of PURCHASE if not bought through PetNovations**). Such replacement services shall be rendered solely by PetNovations, Inc. If any defects should be found in this product, please call PetNovations Customer Service at toll free 1-888-SELF-WASH. A new or remanufactured part will be shipped directly to you and the outbound shipping and duty is your responsibility. Once you receive the replacement product, kindly box the defective product, in the replacement box, with the prepaid return label and return to **PetNovations, Inc. Suite 100, Valley Forge Business Center, 705 General Washington Ave., Norristown, PA, USA. 19403. This warranty is void and the owner will be charged for the replacement part if the owner repairs or modifies the product in any way or does not return the part if requested.**

C. PetNovations, Inc. **is not liable for incidental or consequential damages of any nature. There is no implied or express warranty of merchantability or fitness for a particular purpose on this product.** Some states do not allow the exclusion of incidental or consequential damages or limitations on how long an implied warranty lasts, so these limitations or exclusions may not apply to you. This warranty gives you specific legal rights and may also have other rights, which vary, from state to state.

EXCEPTIONS You are prohibited from using the software or the hardware comprising the CatGenie except as expressly intended by PetNovations, Inc. Any modification of the CatGenie, including, for example, by using a device that resets the counter embedded on the CatGenie cartridges, is unauthorized, voids the warranty set forth above and exceeds the scope of the license granted to you by PetNovations, Inc. You will be solely responsible for any damage, harm or loss related to your misuse or unauthorized use of the CatGenie. Further, PetNovations, Inc. will seek full remuneration for any damage, harm or loss incurred by PetNovations, Inc. related to your misuse or unauthorized use of the CatGenie. **If you have any questions concerning your product or warranty, call Customer Support Toll Free: 1-888-SELF-WASH (1-888-735-3927)**