



DES L2/L3



Splittable frame for cables with and without connectors

- ▶ For 2 or 3 small SPP grommets
- ▶ Frame screws in AISI304 Stainless Steel
- ▶ IP66 and NEMA 4X* certified with all configurations of grommets
- ▶ Strain relief according to EN 62444
- ▶ Sturdy construction IK10
- ▶ Overmolded gasket acc. to UL94-V0
- ▶ ATEX version on request (see group 7)
- ▶ Threaded inserts version on request

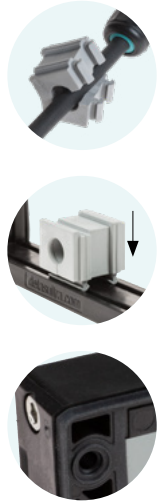
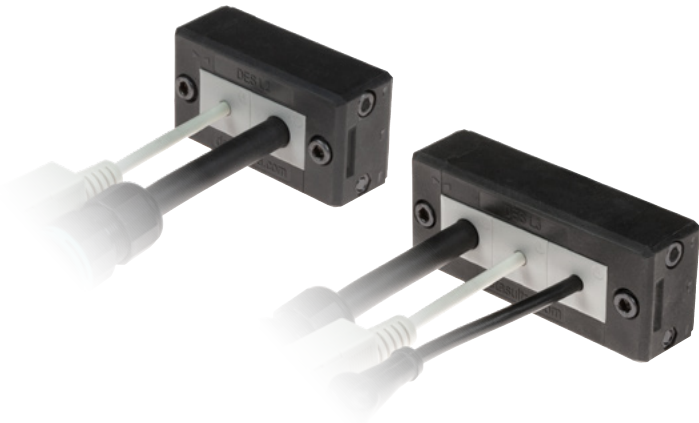

Model	Code	Some possible configurations	Max. cut-out [mm]	Pcs /pack
DES L2	1731010002		40 x 18	10
DES L3	1731010003		63 x 18	
Upon request:	1731991010	Set of 2 mounting screws in AISI304 with Black Dacromet finishing		

The DES L2/L3 cable entry system consists of a splittable frame designed to accommodate small (SPP) grommets for cables with or without connectors.

With all combinations of grommets, single, double, quadruple, the IP66 and NEMA 4X* are guaranteed.

The overmolded gasket guarantees faster installation times and the complete V0 self-extinguishing of the system.

Technical data

Material: PP+GF

Flammability: self-extinguishing acc. to UL94-V0

Temperature: -40°C... +155°C (static)

Features: halogens and silicones free

Related products

SPP grommets (from page 43)

HY360 hydraulic punch driver (page 129)

DES caps (page 58)

Dimensions [mm]

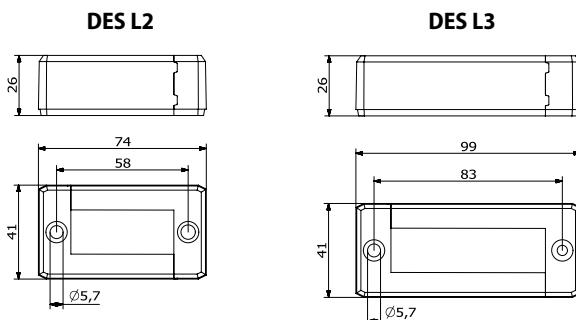

* Indoor only

