



Motic®

MORE THAN MICROSCOPY

AE30 | Upgradeable Live Cell Microscope Platform



AE30 | Upgradeable Live Cell Microscope Platform

With the introduction of its premium **AE30 Series of Inverted Microscopes**, Motic joined the group of manufacturers capable of providing **High-End optics, ergonomic design** and craftsmanship as well as **durable product quality**. Motic doing so, however, all at an **affordable price point**. The AE 30 Series quickly became the perfect solution for all kind of **routine microbiological work** in clinical and pharmaceutical laboratories as well as in demanding University teaching and research environments.

Designed for Routine as well as Research applications, the AE30 Series meets most of the requirements of an Inverted microscope. Motic's proven **CCIS® Infinity Optics** guarantees **superb image quality** and **maximum reliability**. The model's long-working distance objectives ensure an efficient work through a wide variety of laboratory applications.

Standard Contrast techniques such as **Bright field** and **Phase contrast** are supported by the AE30's optimal light management system, featuring easy-to-use standard **Koehler illumination**. Upgradeability to **EPI- Fluorescence** is also offered for the entry level of Research applications.

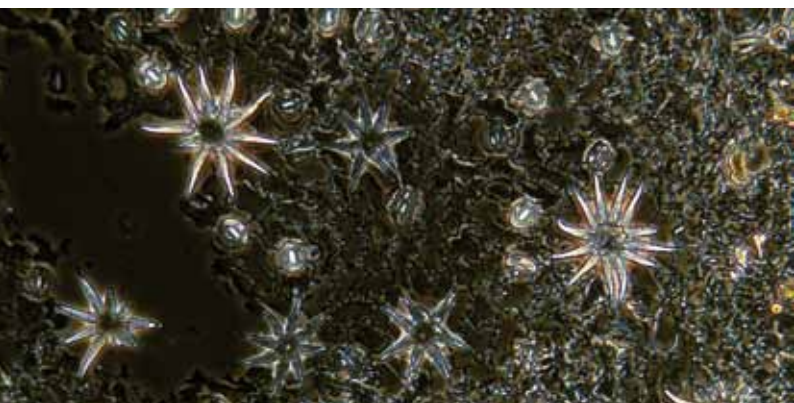





Stands

Designed as an Inverted microscope series with **multiple applications** in mind, the AE30 is available in **3 stand variations**: a Binocular and (2) different Trinocular versions - each coming with a small footprint to meet limited space conditions in modern laboratories. Also, the instrument's "Y" shaped base provides extra lateral stability.

Effective ergonomic design has been implemented in the AE30 Series to allow **easy and quick access to all important functions**. The focussing knobs and the controls of the attachable mechanical stage are placed conveniently at the user's fingertips. Die-cast aluminium frame alongside a reliable optical design of Motic's well established CCIS® Optical System guarantees a long life-time with repeatable results, even under rough working conditions.





Eyepiece tubes

For all stand types, a **viewing angle of 45°** is realized for comfort and posture management. The **interpupillary distance** can be adjusted between **55-75mm**, ensuring fatigue-free observation.

Besides the standard Binocular stand, the Trinocular versions come with **2 different beam-split options**. For **light-sensitive methods** like Fluorescence, Motic recommends the **100:0/0:100 beam split**, allowing 100% of the light to pass through to the photo exit and thus simplifying imaging work especially with living samples.

For **standard applications** like Bright field and Phase contrast, the **100:0/20:80 split** may be more appropriate, allowing simultaneous observation through the eyepieces as well as the image displayed on screen by using a camera. A complete range of Motic digital cameras, in both affordable CMOS and scientific CCD options, are available.

All eyepiece tubes come with a **22mm Field of View (FOV 22)** that allows a fast screening and easy sample detection for improved daily workflow.

Description	F.N.
Widefield WFPL 10X	22
Widefield WFPL 12.5X	17.5
Widefield WFPL 15X	14.5

Eyepieces

In the AE30 Series, Motic's Infinity Corrected CCIS® Optical System displays field flatness across its entire 22mm intermediate image plane. The **high eye point** principle of the AE30's eyepieces ensures **true colour** and **sharp resolution**, while minimizing eye fatigue and strain. Each eyepiece contains a **diopter adjustment**, an integral part to help spectacle wearers, in addition to optimized reticule usage.

Besides the standard eyepieces 10X/22, the AE30 Series also offers **higher magnification eyepieces**.

Eyepiece reticules

The Motic AE30 Series offers a number of **reticules for measuring purposes**.

These include:

Special reticules are also available on request

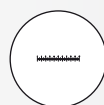

Graduated
linear hair point =
0.1mm/10mm



Graduated
cross hair point =
0.1mm/10mm



Plain cross hair

Nosepiece

With its ball-bearing mechanism, the **AE30's quintuple nosepiece** ensures maximum **parcentration** and **repeatability** with every magnification change. The **side-facing** orientation allows a quick view on the objective when changing manually the magnification.

When dealing with liquids, the **sealed nosepiece** on the AE30 Series prevents fluid spills from getting into the inner instrument's mechanics, guaranteeing **trouble-free usage over many years**.



Objectives

Long working distance (LWD) objectives are essential for use with all Inverted Microscopes. This lens design allows **easy focussing** through the bottom of various culture media into the nutrition media, especially in cases of non-adherent cells. Further, optical compensation is designed for thick vessel bottoms of Petri dishes or well plates to ensure **maximum image quality**.

Motic's AE30 CCIS® objectives fulfil two criteria critical for optimal sample viewing: these Plan Achromats are designed for **improved contrast** as well as **field flatness over the entire 22mm Field of View**.

For higher magnifications, especially when using Fluorescence, a 60X/0.80 bright field lens is available.

Magnification	N.A.	W.D. (mm)
Plan Achromat 4X	0.10	23,5
Plan Achromat 10X	0.25	7,5
Plan Achromat LWD 20X	0.40	7
Plan Achromat LWD 40X	0.60	2,8
Plan Achromat LWD 60X	0.80	1,4
Plan Achromat Phase 10X	0.25	7,5
Plan Achromat Phase LWD 20X	0.40	7
Plan Achromat Phase LWD 40X	0.60	2,8

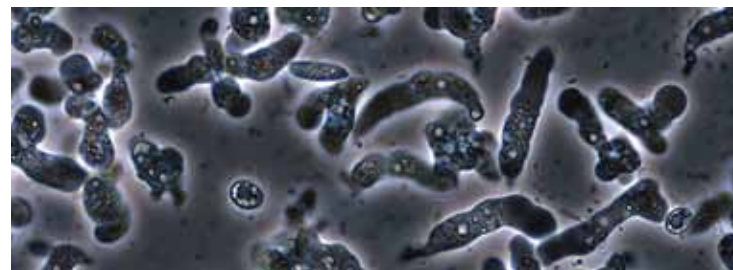



Stage

The AE30's convenient **low positioned fixed stage** plate, optimized for viewer posture and easy access, has a hard **coated surface** resistant against abrasion and corrosion. All standard microscope packages come with both a **glass and metal stage insert**. The glass insert gives an easy view of the objective used.

The standard stage plate of 200x260mm can be enlarged by adding a pair of **auxiliary extension plates**.

The **optional attachable x/y stage** comes with a well plate holder of 128x86mm included. Inserts for all common Petri dish sizes, cell culture vessels, standard glass slides and haemocytometer are available on request.



Condenser

The **standard condenser** of Motic's AE30 Series has a **working distance of 72mm**, giving sufficient working space for most vessels. It can be adjusted in height by a brass rack and pinion system. This material ensures a **long life time** and **precise movement**. Together with the field diaphragm located in the illumination arm, Koehler illumination is easily set up.

The phase ring slider carries 2 phase rings (Ph1 for 10X/20X; Ph3 for 40X) as well as a bright field position. All Phase lenses are therefore covered with one Phase ring set. Adjustment of the phase rings is performed by 2 Allen keys and a Centering Telescope.

A higher illumination aperture for demanding samples can be achieved by an **optional condenser of NA 0.5** (WD=28mm, requiring a separate Phase ring set). Without condenser body, the free working distance can be increased up to 231mm.



Built-in field diaphragm

Filter holder

Knobs for centering the condenser



Illumination

The AE30's **6V/30W Halogen light source** provides a bright and even illuminated image at any magnification. Its **centerable lamp house** can be adjusted by external knobs without any special tool.

The illuminated field can be varied by a **built-in field diaphragm**; while a filter holder may carry different glass filters for colour temperature adjustments or other imaging requirements.

Together with the condenser system, perfect Koehler illumination setup can be performed.

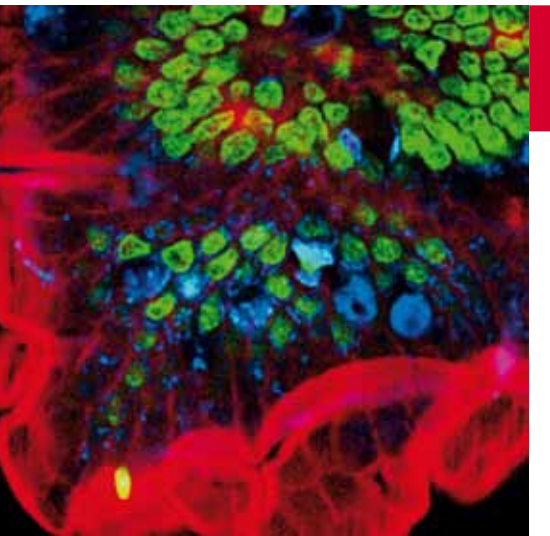

Fluorescence

The modular concept of the AE30 Series allows an **easy upgrade to an EPI-Fluorescence microscope** by using the fluorescence attachment. This slider-device may carry up to 3 filter cubes. The optional Fluorescence package consists of:

Fluorescence attachment with 3 filter positions

XBE-HBO 100W lamp house with mirror for improved brightness

Starter unit

A **complete range of filter cubes** is available, covering all routine applications from UV to NIR excitation. Supplied with band pass barrier filters, multi colour applications can also be performed. **Specialized filter combinations are available upon request.**



The newly designed XBE-HBO lamp house with improved light management offers a more powerful excitation, resulting in brighter signals. In combination with a Moticam Pro Digital camera, excellent images are ensured.

Designed for improved contrast and high resolution, Motic recommends also the Plan Fluorite objective series for weaker fluorescence signals. Higher Numerical apertures lead to brighter fluorescence signals and easier documentation, but working distances are shorter than conventional LWD objective types.

Petri dishes with 0.17mm glass bottoms or slides turned upside-down are the appropriate samples.

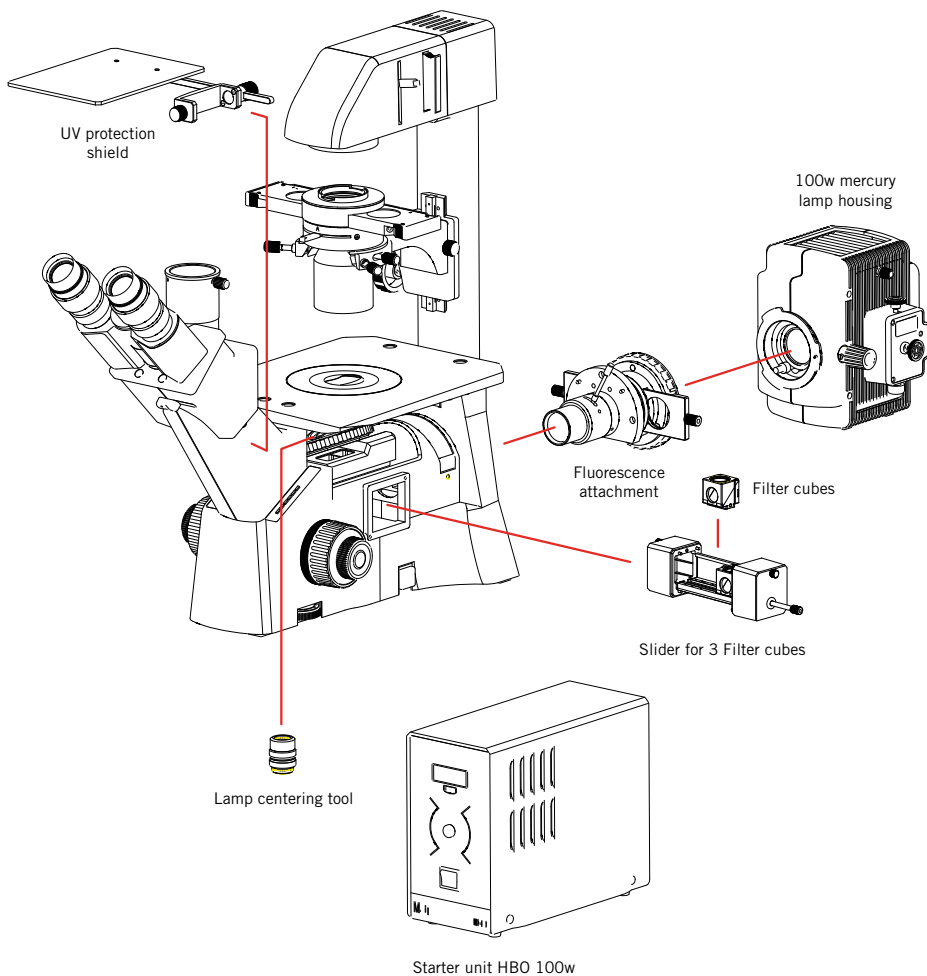

Standard filters of the price list:

DAPI and Hoechst set

Exciter D350/50X
Dichroic 400DCLP
Emitter D460/50m

FITC/RSGFP/Fluo 3/DIO Acradine orange(+RNA) set:

Exciter D480/30X
Dichroic 505DCLP
Emitter D535/40m

FITC (Long Pass) set

Exciter D470/40X
Dichroic 505DCLP
Emitter E515LPv2

TRITC (Rhodamine)/DiI/Cy3 set

Exciter D540/25X
Dichroic 565DCLP
Emitter D605/55m

Texas Red/Cy3.5 set

Exciter D560/40X
Dichroic 595DCLP
Emitter D630/60

Cy5, Alexa Fluor 633, Alexa Fluor 647 set

Exciter HQ620/60X
Dichroic Q660LP
Emitter HQ700/75m

Cyan GFP set

Exciter D436/20X
Dichroic 455DCLP
Emitter D480/40m

Endow GFP Bandpass Emission set

Exciter HQ470/40X
Dichroic Q495LP
Emitter HQ525/50m

Yellow GFP BP (10C/Topaz) set

Exciter HQ500/20X
Dichroic Q515LP
Emitter HQ535/30m

Specialized filter combinations are available on request.

Documentation

Today accurate **image documentation** is becoming an increasingly important part in most, if not all, natural science applications

With the AE30 Series the end-user may choose between **several different imaging options**



CCD Adapter

Based on the **chip size of the C (CS)-mount camera** in use, and the desired field of screen display, Motic has developed a series of **video adapters** for the AE30 Series. From 0,5X to 1X: the customer may follow his preference for **Field of Display** or **Resolution**. The smaller the adapter's factor ($0,5X < 0,65X < 1X$), the larger the displayed field. At the same time the shown resolution on the screen is minimized.



Standard Photomicrography

The traditional use of a **single lens reflex camera**, today mostly digital, requires one of the Trinocular versions of the AE30 Series. The adaptation of the camera consists of a **mechanical adapter combined with a photo eyepiece (2.5X or 4X)**. The necessary **T2 adapter** referring to the camera model is supplied by the respective camera manufacturer. This setup delivers high resolution images of small fields.

Digital Documentation

A **more convenient setup** is provided through Motic's philosophy of easy image digitalization. The combination of an AE30 with a member of the **Moticam series** of digital cameras delivers **excellent live images**, which can easily be stored for future usage. **All Motic cameras come equipped with software** to transform the AE30 into an analysis and documentation workstation. For the Binocular AE30, eyepiece adapters for Motic cameras are available.

Motic offers a complete range of digital cameras, starting with a **basic resolution of 1.3MP** (CMOS) up to the research grade Moticam Pro Line (CCD) with a **maximum of** (at the moment) **5MP**, including **Monochrome** and **Cooled versions**. These Moticam cameras deliver sharp live images with an easy post-capture handling.

For further details on our range of cameras, as well as on adaptation questions, please contact your nearest Motic office or your local authorized Motic Professional reseller.

AE30 Standard Specifications

Model	AE30
Optical System	Colour Corrected Infinity Optical System [CCIS®]
Observation Tube	Widefield Binocular, 45° viewing angle Widefield Trinocular, 45° viewing angle, light distribution 100:0/20:80
Eyepieces	Widefield High Eyepoint, WFPL10X/22mm, with diopter adjustment
Nosepiece	Left side orientated, quintuple
Stage	200X260mm surface
Condenser	ELWD N.A. 0.3, working distance 72mm Without condenser: working distance 231 mm
Focus	By nosepiece movement, 10 mm Coaxial focusing knobs Coarse focus with torque adjustment Fine focus with 2µm minimum increment
Illumination	6V/30W Quartz Halogen with intensity control, Koehler Illumination

AE30/31 Schematic Diagrams

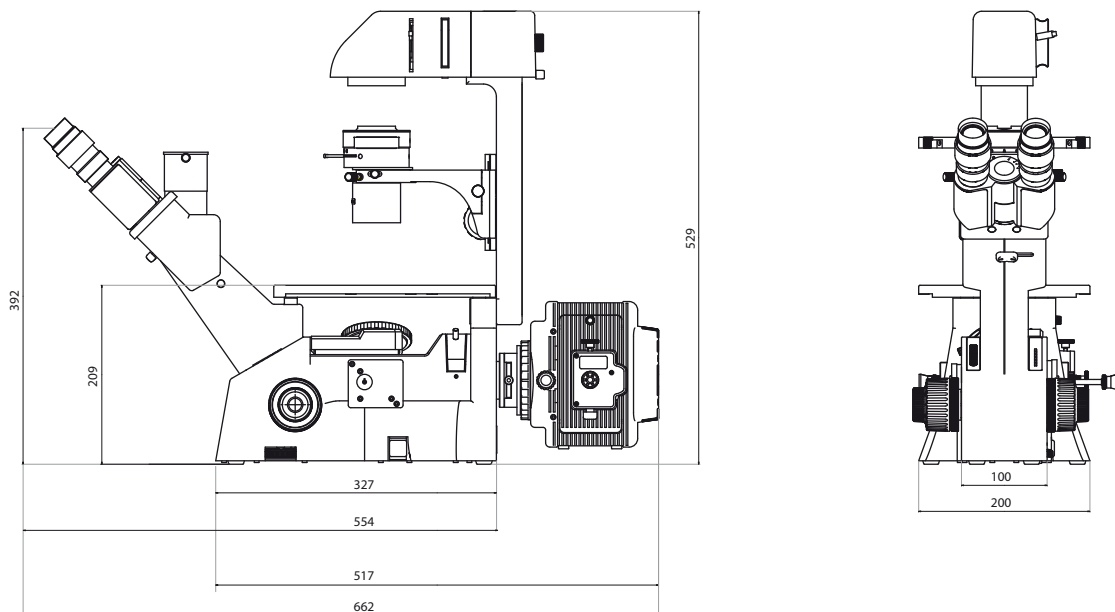

AE30/31 System Diagram

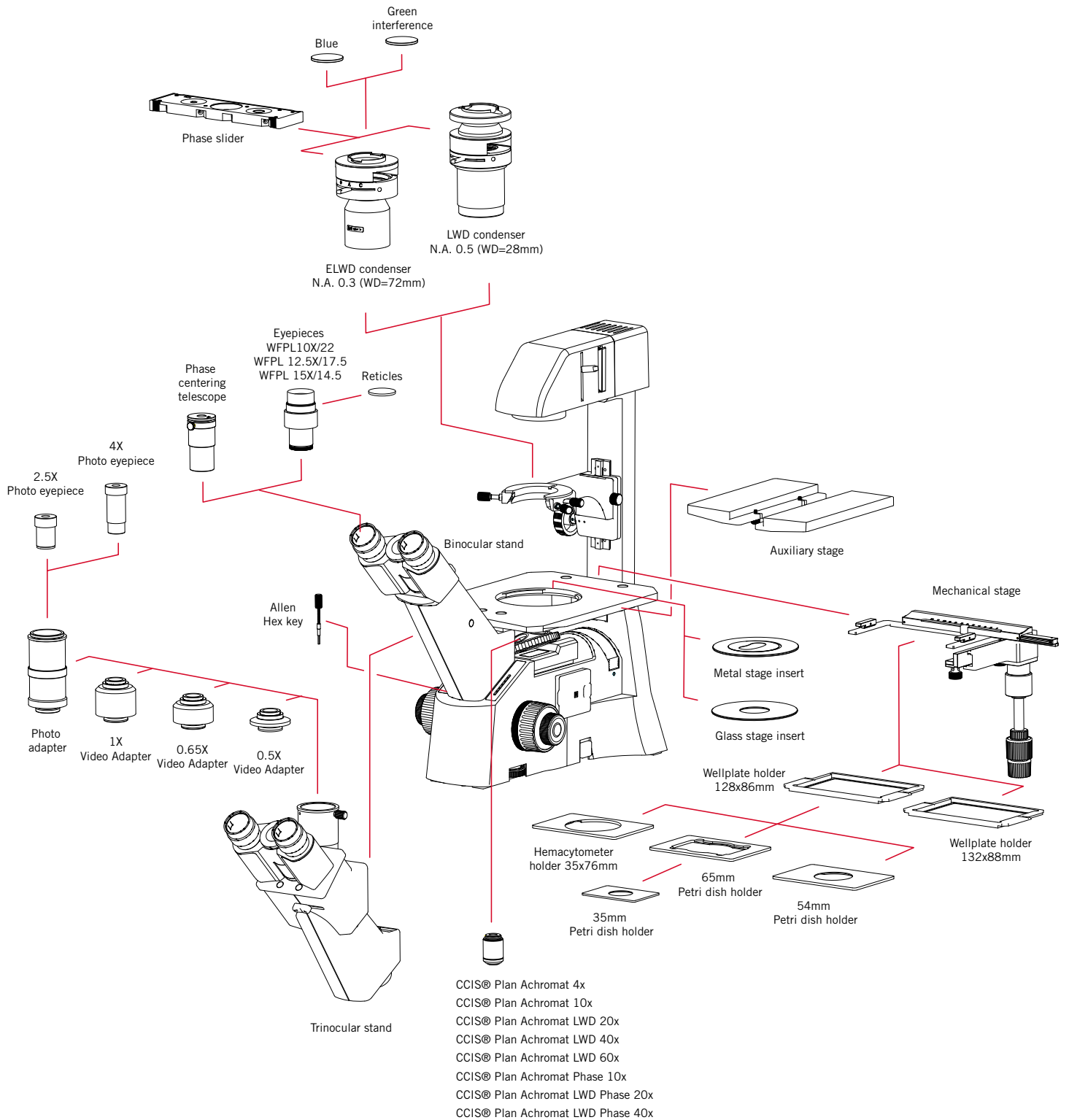



Motic®

www.motic.com

Motic Instruments (CANADA)

130 - 4611 Viking Way. Richmond, BC V6V 2K9 Canada
Tel: 1-877-977 4717 Fax: 1-604-303 9043

Motic Deutschland GmbH (GERMANY)

Christian-Kremp-Strasse 11, D-35578 Wetzlar, Germany
Tel: 49-6441-210 010 Fax: 49-6441-210 0122

Motic Incorporation Ltd. (HONG KONG)

Rm 2907-8, Windsor House, 311 Gloucester Road,
Causeway Bay, Hong Kong
Tel: 852-2837 0888 Fax: 852-2882 2792

Motic Spain, S.L. (SPAIN)

Polígono Industrial Les Corts, Camí del Mig, 112
08349 Cabrera de Mar, Barcelona, Spain
Tel: 34-93-756 6286 Fax: 34-93-756 6287

* **CCIS®** is a trademark of Motic Incorporation Ltd.

**Motic Incorporation Limited Copyright © 2002-2011.
All Rights Reserved.**

Design Change :

The manufacturer reserves the right to make changes in instrument design in accordance with scientific and mechanical progress, without notice and without obligation.



April 2011
Designed in Barcelona (Spain)

