

DATASHEET

STARPACK 1x7 r-PET

SIDE VIEW



FRONT VIEW



TOP VIEW



DATASHEET

STARPACK 1x7 r-PET

UNITS: 1

EGGS/UNIT: 7

MATERIAL: r-PET 

PROCESSING: vacuum formed

CALIBER:

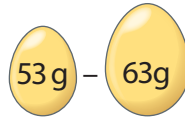

certified according to BRC/IoP Global Standard-Packaging



LAYER STRUCTURE

4 Boxes/Layer



TRUCK LOADING

Pieces/Box	360
Pieces/Pallet	11520
Pallets/Truck	31
Pieces/Truck	357120



CONTAINER LOADING

20"	143640 pcs.
40" HC	336960 pcs.



DECORATION

Label Print



STORAGE

Pallet Dimensions (mm) 1250 x 800 x 2682

Pallet Dimensions (inches) 49.21" x 31.50" x 105.59"

max. 1 year



no pallet on top of the other



max. +40°C
min. +10°C



Do NOT expose
to sunlight

BOX DIMENSIONS



780 x 305 x 311 mm (L x W x H)

30.71" x 12.01" x 12.24" (L x W x H)

Net Weight (kg) 7.83

Box Weight (kg) 0.76

Gross Weight (kg) 8.59

Volume Box (m³) 0.074

PACK DIMENSIONS

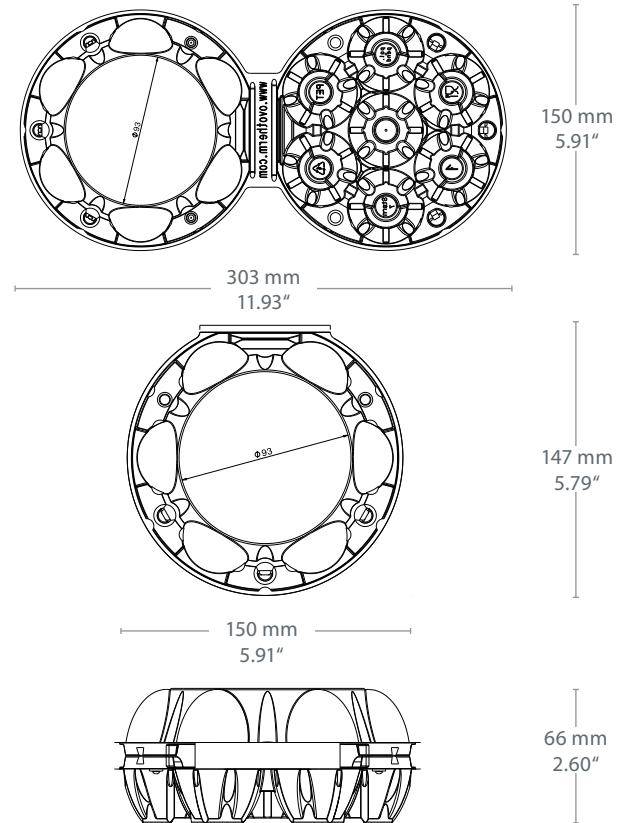

Remark: Stacking Height: 63.5 mm

OVOTHERM International Handels GmbH

Ricoweg 28, 2351 Wiener Neudorf, Austria / Europe

phone +43 2236 61928 0, fax +43 2236 62741

email office@ovotherm.com, email sales@ovotherm.com

