



Quality Refrigeration

OWNER'S MANUAL

Instructions for the installation, operation
and maintenance of Traulsen:

TS Series Pizza/Salad/Sandwich Prep Tables
TS048HT, TS066HT, TS072HT & TS090HT



This Traulsen unit is built to our highest quality standards. We build our refrigerators this way as a matter of pride. This philosophy has made Traulsen the leader in commercial refrigeration since 1938. We thank you for your choice and confidence in Traulsen equipment and we know you will receive many years of utility from this equipment.

All Traulsen units are placed on a permanent record file with the service department. In the event of any future questions you may have, please refer to the model and serial number found on the name tag affixed to the unit. Should you need service, call us on our toll free number, 800-825-8220 between 7:30 am - 4:30 pm CST, Monday thru Friday. You may also log onto www.traulsen.com for further information. It is our pleasure to help and assist you in every possible way.

INSTALLER

COMPLETE THE FOLLOWING INFORMATION PRIOR TO UNIT INSTALLATION

INITIAL START DATE: _____ SERIAL NO. _____

MODEL TYPE: _____

COMPANY/INDIVIDUAL NAME: _____

INSTALLER: _____

TABLE OF CONTENTS

I. THE SERIAL TAG	Page 1	e-Enter The Service Access	Page 7
II. RECEIPT INSPECTION	Page 2	f-Customer/Service Parameters	Page 7
III. OPERATIONAL GUIDELINES	Page 2	g-Adjusting Thermostat Set Point	Page 8
IV. INSTALLATION		h-Adjusting Thermostat Set Point Differential	Page 8
a-Location	Page 2	i-Changing The Temperature Scale	Page 8
b-Packaging	Page 2	j-Setting The 24-Hour Clock	Page 8
c-Installing/Adjusting Legs or Casters	Page 2	k-Setting The Date	Page 9
d-Doors	Page 2	l-Setting Daylight Savings Time	Page 9
e-Installing Optional Drawers	Page 2	m-Starting A Manual Defrost Cycle	Page 10
f-Cord & Plug	Page 2	n-Setting Defrost Lockouts	Page 10
g-Power Supply	Page 3	o-Adjusting The Room Temperature Offset	Page 11
V. DAILY OPERATION		p-Viewing Sensor Temperatures	Page 11
a-Pans	Page 3	VIII. WIRING DIAGRAM	Page 12
b-Setting Up The Rail	Page 3	IX. TROUBLE SHOOTING GUIDE	Page 13
c-Closing Down The Rail At Night	Page 3	X. SERVICE ASSISTANCE	
d-Defrost	Page 3	a-Service Information	Page 14
VI. CARE & MAINTENANCE		b-Service Support Information	Page 14
a-Cleaning The Condenser/Filter	Page 4	c-Warranty Registration	Page 14
b-Replacing The Gaskets	Page 4	XI. WARRANTIES	Page 15
c-Cleaning The Cabinet Surfaces	Page 4	XII. SERVICE PARTS LIST	Page 16
d-Cleaning The Rail Area	Page 4		
VII. MICROPROCESSOR CONTROL			
a-Control Features	Page 5		
b-Alarm Explanations	Page 6		
c-Control Panel Diagram	Page 7		
d-Notes To The User	Page 7		



I. THE SERIAL TAG

I. a - SERIAL TAG:

The serial tag is a permanently affixed label on which is recorded vital electrical and refrigeration data about your Traulsen product, as well as the model and serial number. This tag is located in the right interior compartment on all standard TS Series models.

READING THE SERIAL TAG

- Serial = The permanent ID# of your Traulsen unit
- Model = The model # of your Traulsen unit
- Volts = Voltage
- Hz = Cycle
- PH = Phase
- Total Current = Maximum amp draw
- Minimum Circuit = Minimum circuit ampacity
- Lights = Light wattage
- Heaters = Heater amperage (Hot Food units only)
- Refrigerant = Refrigerant type used and refrigerant charge
- Design Pressure = High & low side operating pressures
- Agency Labels = Designates agency listings

 <small>FORT WORTH, TX.</small>				
SERIAL	MODEL	PH		
VOLTS	Hz			
TOTAL CURRENT	AMPS			
MINIMUM CIRCUIT	AMPS			
MAXIMUM OVERCURRENT PROTECTION		AMPS		
LIGHTS	WATTS			
HEATERS	AMPS			
REFRIGERANT		TYPE	OZ	
DESIGN PRESSURE	HIGH		LOW	
REFRIGERANT		TYPE	OZ	
DESIGN PRESSURE	HIGH		LOW	
<small>370-60294-00 REV (A)</small>				
 		COMMERCIAL REFRIGERATION		

II. RECEIPT INSPECTION

II. a - RECEIPT INSPECTION:

All Traulsen products are factory tested for performance and are free from defects when shipped. The utmost care has been taken in crating this product to protect against damage in transit.

You should carefully inspect your unit for damage during delivery. If damage is detected, you should save all the crating materials and make note on the carrier's Bill Of Lading describing the damage. A freight claim should be filed immediately. If damage is subsequently noted during or immediately after installation, contact our customer care team to file a freight claim. There is a fifteen (15) day limit to file freight damage with the carrier. Under no condition may a damaged unit be returned to Traulsen without first obtaining written permission (return authorization). You may contact Hobart/Traulsen customer care at 800-333-7447 to request a return or file a claim.

III. OPERATIONAL GUIDELINES

III. a - OPERATIONAL GUIDELINES:

Follow these simple guidelines for proper TS Series Operation.

1. Keep the condenser clean. Don't obstruct airflow.
2. Use up to 6" deep stainless steel or aluminum pans.
3. All pan spaces should be filled any time the unit is running, even if some pans are empty.
4. Keep the room temperature at 86°F (30°C) or less.
5. Do not allow air drafts (such as heat, A/C or ventilation) to blow on or over the rail area. This will disrupt the air blanket over the product area, resulting in poor holding temperatures.
6. Rail covers should be closed over the rail as much as possible.
7. Product should be loaded into the rail at a maximum temperature of 36°F. The TS Series unit was not designed to chill warm product, but to hold refrigerated product at a safe temperature.
8. Keep area around the evaporator fans clear.

IV. INSTALLATION

IV. a - LOCATION:

Select a proper location for your unit, away from extreme heat or cold. Allow enough clearance between the unit and the side wall in order to make use of the door stay open feature at 120° (self-closing feature operates up to 90°). The door(s) must be able to open a minimum of 90° in order to make use of the maximum clear door width.

IV. b - PACKAGING:

Your Traulsen unit is shipped from the factory bolted to a sturdy wooden pallet in stretch wrapped material and wood crate.

Most exterior stainless steel surfaces have a protective vinyl covering to prevent scratching during manufacturing, shipping and installation.

After the unit is installed in place of application peel, remove and discard the covering from all surfaces.

IV. INSTALLATION (CONTINUED)

IV. b - PACKAGING (continued):

To remove the wooden pallet, first if at all possible, we suggest that the cabinet remain bolted to the pallet during all transportation to the point of final installation. The bolts can then be removed with a 1/2" socket wrench. Avoid laying the unit on its front, side or back for removal of the pallet.

NOTE: Traulsen does not recommend laying the unit on its front, side or back. If you must, please allow the unit to remain in an upright position for 24 hours before plugging it in so that the compressor oils and refrigerant may settle.

IV. c - INSTALLING/ADJUSTING LEGS OR CASTERS:

To install legs or casters, slide leg or caster into the caster channel from the side of the unit without the refrigeration system.

To adjust the legs or casters, loosen the two bolts and move leg or caster to desired location, spacing between leg or caster not to exceed 48 inches. Leg or caster on each end of the unit can not exceed 8 inches from the end of the cabinet.

NOTE: Traulsen recommends to position legs or casters under the mullion when possible.

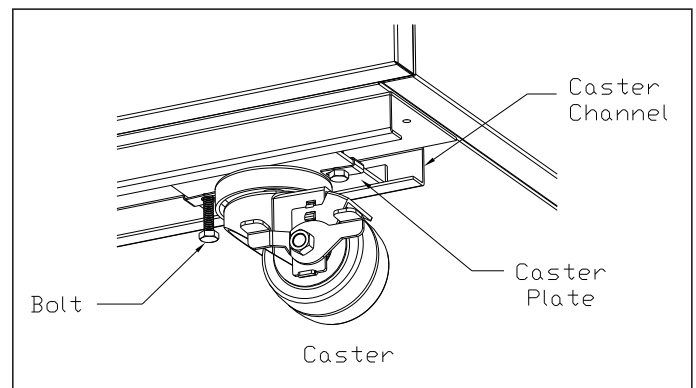

IV. d - DOORS:

Your Traulsen TS Series model door(s) are field re-hingeable. If re-hinging is required, please contact our in-house service department at 800-825-8220 for re-hinging instructions.

IV. e - INSTALLING OPTIONAL DRAWERS:

Doors are supplied standard on all TS Series models. However, we have engineered our refrigerator models with a drop-in feature that allows you to easily convert door(s) into two 6" deep drawers or three 4" deep drawers.

The door(s) on the refrigerator models can easily be converted to drawers in the field. To begin the process, open the door to its maximum position. Support the non-hinged end of the door so minimum movement occurs. When the bolts from the lower hinge plate are removed, remove the lower hinge plate and then the door from the top hinge bracket plate and then the door from the top hinge bracket. The hinge plate pin and plastic bushing will remain in the top hinge plate.

NOTE: The lower hinge plate is under spring tension.

IV. INSTALLATION (continued)

IV. e - INSTALLING OPTIONAL DRAWERS (continued):

Once the door(s) have been removed, Insert drawer frame as shown below.

NOTE: Undercounter model drawings shown below.

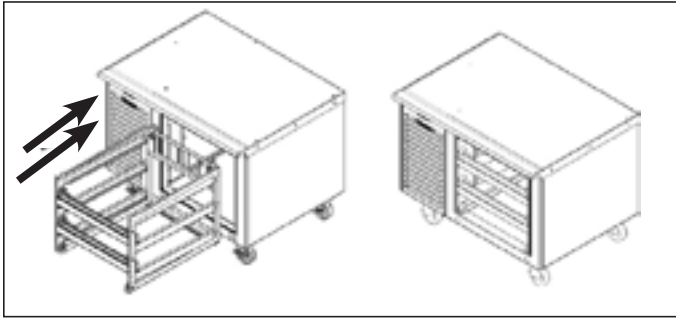

Once the drawer frame has been inserted, the drawer frame module can be installed by tightening the black front and back clamping knobs (2 of each) located on the cross rail locks and liner locks. Slide the front cross rail locks towards the center of the drawer frame module and allow the liner locks to drop down from the top of the liner. Insert the door frame module push towards the back of the unit. The entire frame assembly is now installed and ready for use.

NOTE: Repeat process for multiple drawer inserts.

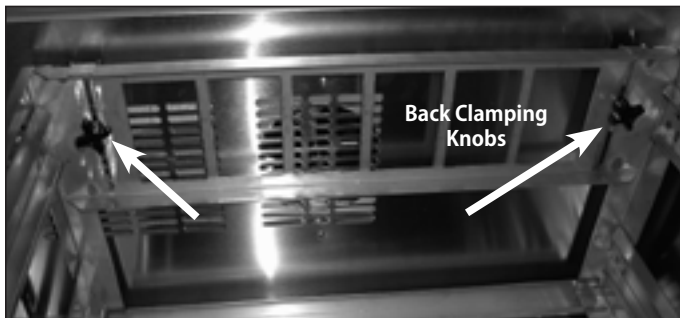
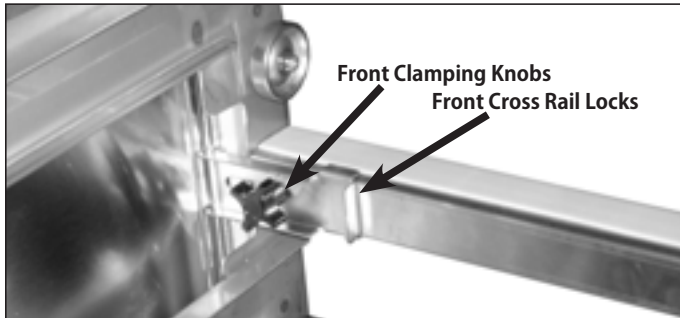

IV. f - CORD & PLUG:

All self-contained models are shipped standard with a NEMA 5-15P plug and 9 foot cord . Select only a dedicated electrical outlet for power source.

NOTE: Do not under any circumstances, cut or remove the round grounding prong from the plug, or use an extension cord.

IV. INSTALLATION (continued)

IV. g - POWER SUPPLY:

The supply voltage should be checked prior to connection to be certain that proper voltage for the cabinet wiring is available (refer to the serial tag to determine correct unit voltage, see page 1). Make connections in accordance with local electrical codes. Use qualified electricians.

Use of a separate, dedicated circuit is required. Size wiring to handle indicated load and provide necessary over current protector in circuit (see amperage requirements on the unit's serial tag).

V. DAILY OPERATION

V. a - PANS:

Standard TS Series models are designed to operate with full, half or third size pans without the use of adapter bars. Other fractional size pans can be used with optional adapter bars available from Traulsen. 4" deep pans provide the best temperature performance in the rail. Both 2" & 6" deep pans will also perform to NSF7 temperature requirements.

V. b - SETTING UP THE RAIL:

Install pans in all pan spaces in the rail. Rest each pan evenly on the front and back support ledges. Do not use uneven or bent pans, as these will allow circulating cold air to escape.

Allow the unit to reach operating temperature before loading any food product. Load only refrigerated product at 36°F or below.

All pan spaces should be filled, even if some pans are empty (even during nighttime storage).

When not in constant use, the TS Series rail covers should be kept closed over the pans.

V. c - CLOSING DOWN THE RAIL AT NIGHT:

Food product may be stored in the rail overnight if needed. Cover the entire rail with plastic wrap prior to closing the rail covers over the pans.

V. d - DEFROST:

The Traulsen refrigerated Prep Table is equipped with an automatic hot gas defrost system which clears the evaporator coil of any accumulated frost. Frost accumulates on the evaporator coil during the normal refrigeration or cool cycle. The defrost cycle occurs automatically every three hours and is indicated by the illumination of the green snow flack and the letters "DEF" displayed on the screen of the Inteltra-Traul control. The defrost cycle should last for approximately ten to twenty minutes. At the completion of the defrost cycle the cabinet will resume normal refrigeration operation with the compressor cycling ON and OFF to maintain cabinet and rail temperature.

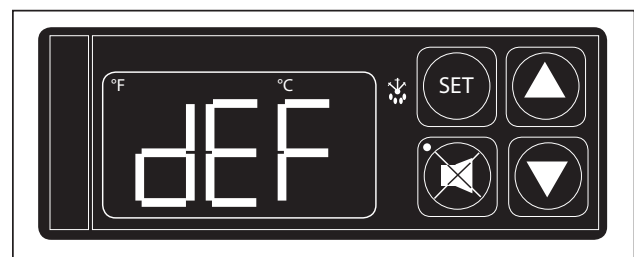

VI. CARE & MAINTENANCE

VI. a - CLEANING THE CONDENSER/FILTER:

The most important thing you can do to insure a long, reliable service life for your Traulsen is to regularly clean the condenser coil and or filter if provided.

The patented microprocessor control will notify you through a "CLN-FIL" message when the condensing temperature of the refrigerator reaches 140 degrees F or greater. If the condensing temperature reaches 160 degrees F the compressor will automatically turn off. When the temperature drops below 140 degrees F the compressor will restart and when the temperature drops below 120 degrees F the alarm will reset.

WARNING: DISCONNECT ELECTRICAL POWER SUPPLY BEFORE CLEANING ANY PARTS OF THE UNIT.

To clean the condenser/filter, first disconnect electrical power to the cabinet and remove the front hinged louver assembly. Proceed to vacuum or brush any dirt, lint or dust from the finned condenser coil/filter, the compressor and other cooling system parts. If significant dirt is clogging the condenser fins or filter, use compressed air to blow this clear. To replace the louver assembly reverse the process.

VI. b - REPLACING THE GASKETS:

To remove the gasket to be replaced, grasp it firmly by one corner and pull it out. Before attempting to install a new gasket, both the unit and the gasket itself must be at room temperature. Insert the four corners first by using a rubber mallet (or hammer with a block of wood). After the corners are properly inserted, work your way towards the center from both ends by gently hitting with a mallet until the gasket is completely seated in place (see figure for proper gasket placement).

NOTE: The gasket may appear too large, but if it is installed as indicated above it will slip into place.

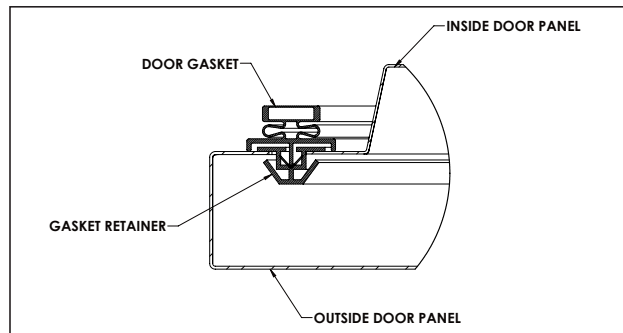

VI. c - CLEANING THE CABINET SURFACES:

WARNING: DISCONNECT ELECTRICAL POWER SUPPLY BEFORE CLEANING ANY PARTS OF THE UNIT.

Exterior stainless steel should be cleaned with warm water, mild soap and a soft cloth. Apply with a dampened cloth and wipe in the direction of the metal grain. Avoid the use of strong detergents and gritty, abrasive cleaners as they may tend to mar and scratch the surface. **Do NOT** use cleansers containing chlorine, such as bleach, this may promote corrosion of the stainless steel.

VI. CARE & MAINTENANCE (continued)

VI. c - CLEANING THE CABINET SURFACES (continued):

Care should also be taken to avoid splashing the unit with water, containing chlorinated cleansers, when mopping the floor around the unit. For stubborn odor or spills, use baking soda and water (mixed to a 1 tbsp baking soda to 1 pint water ratio). A stainless steel polish is recommended for shining of unit.

VI. d - CLEANING THE RAIL AREA :

WARNING: DISCONNECT ELECTRICAL POWER SUPPLY BEFORE CLEANING ANY PARTS OF THE UNIT.

Temperature rail is equipped with drain and flush valve. Up to 5 gallons of water can be used to clean rail compartment.



For excessive spills the front and rear air baffle in the rail are removable by unscrewing the thumb screws.

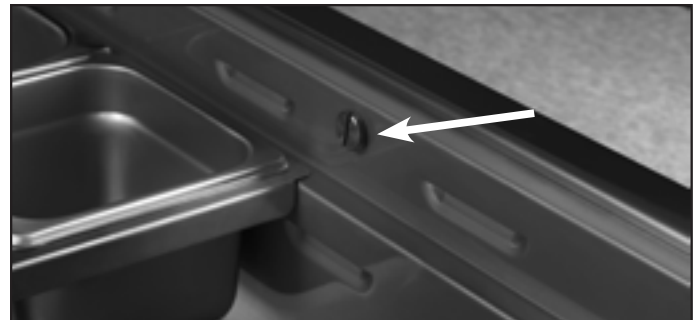

Air baffles can be cleaned in a sink using caution not to loose fasteners.

NOTE: Use caution in avoiding getting excessive water down in cabinet ducts with outer air ducts removed.

VII. PATENTED MICROPROCESSOR CONTROL

Your new refrigerator cabinet is equipped with a state-of-the-art patented microprocessor control, which precisely regulates operation and provides alarms when problems occur. It is supplied from the factory completely ready for use and requires no adjustments, but without the audible alarms activated. See pages 5 thru 11 for more information.

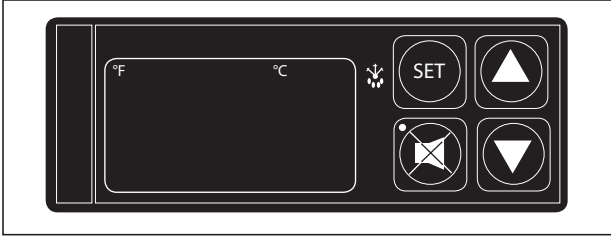

PATENTED MICROPROCESSOR CONTROL

VII. a - CONTROL FEATURES:

1- Internal Time Clock

- Eliminates external defrost time clock.
- Defrost cycle can be quickly adjusted to suit individual location and use.
- Must be set at power-up. (See page 8, "Setting the 24-Hour Clock")
- Will automatically update for Daylight Savings Time.

2- Water Resistant Housing

The face of the control is water resistant to provide for protection during cleaning.

3- Parameter/Service Levels

- See "Customer / Service Parameters" on Page 7.

4- Defrost Lockouts

See "Setting Defrost Lockouts" on page 10.

Customers can set up to 4 different defrost lockout periods. The lockout prevents the unit from going into a defrost cycle during peak kitchen use.

Note: The 24-hour clock must be set for this feature to operate correctly.

5- Communication Ability

A NAFEM Data Protocol (NDP) compliant RS-485 serial communications port is available to interface with data collection software (by others). All microprocessor control equipped models are capable of communicating within a NAFEM Data Protocol network if provided with an optional Gateway Hub (available from Traulsen). The actual communications software is available from a number of third party software vendors.

6- Alarms (See the following pages for explanations)

- High Cabinet Air Temperature
- Low Cabinet Air Temperature
- Loss Of Power
- Sensor Failure
- Clean Condenser

7- Display Features

- 3-Digit LED Display
- Defrost in Progress Icon
- Fahrenheit or Celsius Temperature Scale In Use

VII. PATENTED MICROPROCESSOR CONTROL (continued)

VII. b - ALARM EXPLANATIONS:

Explanation of alarms assume the audible alarm style is set at a 3-second burst or a continuous audible alarm. References to the audible alarm do not apply if the audible alarm style is set to OFF.



High Cabinet Air Temperature

The audible alarm will sound and the display will read HI CAB when the temperature inside the cabinet rises above a pre-programmed limit. The limit is determined by the type of unit being operated (i.e.: refrigerator/freezer). To turn off the audible alarm, press the alarm cancel button. The visual alarm text will continue to display until the cabinet air temperature falls below the limit. If the temperature does not fall below the limit within 5 minutes, the audible alarm* will sound again and an additional Call Service message will display.

POSSIBLE CAUSES:

- Doors open for extended periods of time.
- Large amounts of hot product placed inside the cabinet.
- Condenser coil dirty.
- Cooling Compressor Failure. Call Service.
- Refrigeration Problems.



Low Cabinet Air Temperature

The audible alarm will sound and the display will read Lo Cab when the temperature inside the cabinet falls below a pre-programmed limit. The limit is determined by the type of unit being operated (i.e.: refrigerator/ freezer). To turn off the audible alarm, press the alarm cancel button. The visual alarm text will continue to display until the cabinet air temperature rises above the limit. If the temperature does not rise above the limit within 5 minutes, the audible alarm will sound again and an additional Call Service message will display.

POSSIBLE CAUSES:

- No product in unit.
- Failed sensors.
- Stuck Evaporator Relay.



Loss Of Power

The audible alarm will sound and the display will read ELE LOS, when the unit regains power after an outage. To turn off the audible alarm and/or clear the visual text, press the alarm cancel button.



Condenser Clean

The audible alarm will sound and the display will read "CLEAN FILter" when discharge temperatures exceeds 140 degrees. As the load on the condenser decreases, the alarm will turn off by itself. As the temperature on the condenser continue to rise, the audible alarm will return until the problem has been eliminated.

NOTE: If discharge temperature rises above 160°F the compressor & condenser fan motor will be switched off until the discharge temp falls below 140°F.



Sensor Failures

The audible alarm will sound and the display will read CAB Snr, COL Snr or DIS Snr when that particular sensor has failed to operate. To turn off the audible alarm, press the alarm cancel function of the sensor, the audible alarm will sound again in either 5 minutes or 24 hours.

Note: Test sensor in ice water.

VII. PATENTED MICROPROCESSOR CONTROL (continued)

VII. c - CONTROL PANEL DIAGRAM:

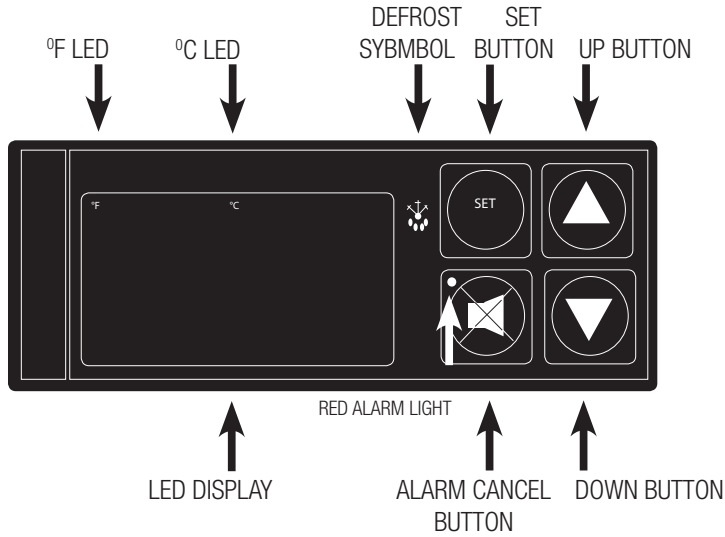

VII. d - NOTES TO THE USER:

You only have 20-30 seconds between button pushes. If you take longer than 30 seconds, the controller will revert back to displaying the cabinet temperature. If you enter the wrong security code, the controller will revert back to displaying the cabinet temperature. You can exit the parameters at any time by waiting 20-30 seconds for the control to return to normal operation.

VII. e - ENTER THE CUSTOMER ACCESS:

Note: This is required to set any of the control parameters.

Use the security code 0, A, 1 and the following instructions: Press the set button . The display will read Customer/Service Access. Press the set button . The display will show three zeros with the left zero flashing . Press the set button . The display will show three zeros with the center zero flashing . Press the down arrow key to sequence through F, E, d, C, b, A, 9, 8, 7, ... etc. When you reach "A" press set . The display will show zero, A, zero with the right zero flashing . Press the up arrow key to sequence through 1, 2, 3, 4, 5, 6, 7, 8, 9, A, b, ... etc. When you reach "1" press set . The display will read Thermostat Set Point. You are now in the **CUSTOMER/SERVICE PARAMETERS**.

VII. f - CUSTOMER/SERVICE PARAMETERS:









Listed below are the available parameters in the order they appear, using the down arrow key on the controller. You can use either the up or down arrow keys to scroll through the options.

	Thermostat Set Point
	Thermostat Set Point Differential
	Room Temperature Offset
	Temperature Scale
	Start Manual Defrost
	Audible Alarm Style
	Time (24-hour clock)
	Date (month-day-year)
	Daylight Savings
	Defrost Lockout 1
	Defrost Lockout 2
	Defrost Lockout 3
	Defrost Lockout 4
	Cabinet Air Temperature
	Evaporator Coil Temperature
	Liquid Line Temperature
	Serial Number

VII. PATENTED MICROPROCESSOR CONTROL (continued)











VII. g - ADJUSTING THE THERMOSTAT SET POINT:

This parameter sets the high point of the desired cabinet temperature range. Typically, refrigerators will range from 36° F to 40° F (2.5° C to 3.3° C) for this parameter setting. This parameter is preset at the factory and does not have to be adjusted unless the customer chooses to do so.

Follow the instructions to enter the customer access code on page 7. When the control display reads  Thermostat Set Point, press the set button . Use the arrow keys   to adjust the temperature to your desired setting. When the display shows the temperature you want press the set button . The display will then read  Thermostat Set Point. You can use the up or down arrow keys to scroll to the next parameter   or wait 30 seconds for the control to return to normal operation.

VII. h - ADJUSTING THE SET POINT DIFFERENTIAL:













This parameter sets the number of degrees the air temp will rise above set point before the refrigeration system will cycle on. The set point differential is set at 1.5 which will allow the air temperature to rise 1.5 degrees above SP (set point) setting before cycling refrigeration on. This parameter is preset at the factory and does not have to be adjusted unless the customer chooses to do so.

Follow the instructions to enter the customer access code on page 7. When the control displays  Thermostat Set Point, press the down arrow key  until the control display reads  Set Point Differential. Press the set button . Use the arrow keys   to adjust the temperature to your desired setting. When the display shows the temperature you want press the set button . The display will then read  Set Point Differential. You can use the up or down arrow keys to scroll to the next parameter   or wait 30 seconds for the control to return to normal operation.

VII. i - CHANGING THE TEMPERATURE SCALE:

The temperature scale determines if the temperature displayed will be in degrees Fahrenheit or degrees Celsius.

Follow the instructions to enter the customer access code on page 7.

When the control displays  Thermostat Set Point, press the down arrow key  until the control display reads  Temperature Scale. Press the set button . The display will start with the current setting either  for degrees Fahrenheit or  for degrees Celsius. Use the arrow keys   to toggle between the options. When the display shows the scale you want press the set button . The display will then read  Temperature Scale. You can use the up or down arrow keys   to scroll to the next parameter or wait 30 seconds for the control to return to normal operation.

VII. j - SETTING THE 24-HOUR CLOCK:

The internal time clock must be set in order for the data storage memory to correctly log events and to allow any defrost lockout to occur at the correct time of day. If the clock is not set, the control assumes the time is 12 a.m. at the time power is supplied to the unit. The hours on a 24-hour time clock read the following way:

H01 = 1:00 a.m.	H09 = 9:00 a.m.	H17 = 5:00 p.m.
H02 = 2:00 a.m.	H10 = 10:00 a.m.	H18 = 6:00 p.m.
H03 = 3:00 a.m.	H11 = 11:00 a.m.	H19 = 7:00 p.m.
H04 = 4:00 a.m.	H12 = 12:00 a.m.	H20 = 8:00 p.m.
H05 = 5:00 a.m.	H13 = 1:00 p.m.	H21 = 9:00 p.m.
H06 = 6:00 a.m.	H14 = 2:00 p.m.	H22 = 10:00 p.m.
H07 = 7:00 a.m.	H15 = 3:00 p.m.	H23 = 11:00 p.m.
H08 = 8:00 a.m.	H16 = 4:00 p.m.	H24 = 12:00 a.m.



VII. PATENTED MICROPROCESSOR CONTROL (continued)

VII. j - SETTING THE 24-HOUR CLOCK (continued):

Follow the instructions to enter the customer access code on page 7.

When the control displays  Thermostat Set Point, press

the down arrow key  until the control display reads



 Clock. Press the set button . The display will

show  Hours. The right two numbers will be flashing.

Use the arrow keys   to set the hour. When the correct



hour is displayed, press the set button . The display will sh

ow  Minutes. The right two numbers will be flash-

ing. Use the arrow keys to set the minutes  . When

the correct minutes are displayed, press the set button . The

display will then read  Clock. You can use the up or down

arrow keys   to scroll to the next parameter, or wait 30



seconds for the control to return to normal operation.

VII. k - SETTING THE DATE:

The date must be set in order for the data storage memory to cor-
rectly log events. Follow the instructions to enter the customer access

code on page 7. When the control displays  Thermostat

Set Point, press the down arrow key  until the control display

reads  Date. Press the set button . The display

will show  (year). The right two numbers will be flashing.

Press the arrow keys   to set the year. When the cor-
rect year is displayed, press the set button . The display will

show  (month). The right two numbers will be flashing.

Use the arrow keys   to set the month. When the

correct month is displayed, press the set button .

VII. k - SETTING THE DATE (continued):

The display will show  (day). The right two numbers will be flashing.

Press the arrow keys   to set the day. When the correct day is

displayed, press the set button . The display will then read 

Date. You can use the up or down arrow keys   scroll to the next

parameter, or wait 30 seconds for the control to return to normal operation.

VII. l - SETTING DAYLIGHT SAVINGS TIME:

This parameter is preset at the factory to automatically adjust the 24-hour clock

for Daylight Savings Time. Follow the instructions to enter the customer access

code on page 7. When the control displays  Thermostat Set

Point, press the down arrow key  until the display reads 

Daylight Savings Time. Press the set button . The display will

show  Daylight Savings Time (Yes, automatically adjust for

Daylight Savings Time). For "YES" press the set button , for "NO"

press the up or down arrow key  . The display will read 

Daylight Savings Time (no). Press the set button . The display will











read  Daylight Savings Time. You can press the up or down ar-

row keys   to scroll to the next parameter, or wait 30 seconds

for the control to return to normal operation.

VII. PATENTED MICROPROCESSOR CONTROL (continued)

VII. m - STARTING A MANUAL DEFROST CYCLE:

This parameter allows a service technician to start a defrost cycle at any time. This parameter will override any lockout settings. Follow the instructions to enter the customer access code on page 7. When the control displays  Thermostat Set Point, press the down arrow key  until the control display reads  Start Manual Defrost. Press the set button . The display will show  (OFF). Press either arrow key   (ON). The display will show . Press the set button . The defrost icon will be lit, and the display will read  when the unit is in defrost.

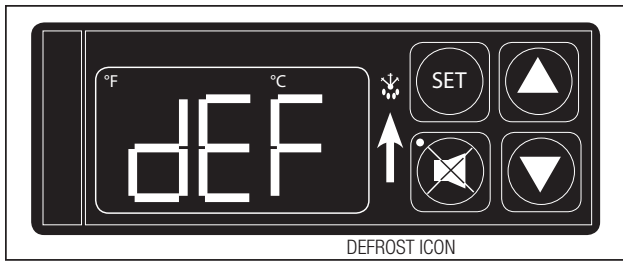

VII. n - SETTING THE DEFROST LOCKOUTS:

The defrost lockout parameters allow the customer to prevent the unit from going into a defrost cycle for two hours during a set time frame. Customers can set up to four defrost lockout parameters. They are all programmed the same way. The parameters will be set for the time the lockout is to start. The controller automatically calculates 2 hours from that setting. The options are similar to the 24-hour clock settings and are in 30-minute increments. Each of the lockout parameters covers 6 hours of the 24-hour clock. Note: The 24-hour clock must be set for this feature to operate at the correct time of day. See "Setting the 24-Hour Clock" on page 8.



OFF

020 = 2:00 a.m.
023 = 2:30 a.m.
030 = 3:00 a.m.
033 = 3:30 a.m.
040 = 4:00 a.m.
043 = 4:30 a.m.
050 = 5:00 a.m.
053 = 5:30 a.m.
060 = 6:00 a.m.
063 = 6:30 a.m.
070 = 7:00 a.m.



OFF

080 = 8:00 a.m.
083 = 8:30 a.m.
090 = 9:00 a.m.
093 = 9:30 a.m.
100 = 10:00 a.m.
103 = 10:30 a.m.
110 = 11:00 a.m.
113 = 11:30 a.m.
120 = 12:00 p.m.
123 = 12:30 p.m.
130 = 1:00 p.m.

VII. n - SETTING THE DEFROST LOCKOUTS (continued):



OFF

140 = 2:00 p.m.
143 = 2:30 p.m.
150 = 3:00 p.m.
153 = 3:30 p.m.
160 = 4:00 p.m.
163 = 4:30 p.m.
170 = 5:00 p.m.
173 = 5:30 p.m.
180 = 6:00 p.m.
183 = 6:30 p.m.
190 = 7:00 p.m.













OFF

200 = 8:00 p.m.
203 = 8:30 p.m.
210 = 9:00 p.m.
213 = 9:30 p.m.
220 = 10:00 p.m.
223 = 10:30 p.m.
230 = 11:00 p.m.
233 = 11:30 p.m.
240* = 12:00 a.m.
243* = 12:30 a.m.
010 = 1:00 a.m.

* Denotes not available.

A lockout can not be programmed to start at 12:00 am or 12:30 am due to conflicts with other internal programs. The defrost lockouts can not be programmed to run back-to-back. For example, if dL1 is set to 080, then a defrost cycle would be locked out from 8:00 am to 10:00 am. Because of the dL1 setting the dL2 parameter would not let the user choose a lockout start time before 10:30 am. All lockouts are preset at the factory to OFF.

Follow the instructions to enter the customer access code on page 7.

When the control displays  Thermostat Set Point, press the down arrow key  until the control the display reads . Press the set button . The display will show  Off. Press the arrow keys   to set the start time. When the correct time is displayed, press the set button . You can press the up or down arrow keys   to scroll to the next parameter, or wait 30 seconds for the control to return to normal operation.



VII. PATENTED MICROPROCESSOR CONTROL (continued)

VII. o - ADJUSTING THE ROOM TEMPERATURE OFFSET:

The room temperature offset parameter allows a service technician or end user the ability to have the display show a temperature that is within three degrees of the actual temperature being read by the cabinet air sensor. This allows for continuity of reading between different temperature reading devices. (i.e.: thermistor vs. thermocouple vs. handheld thermometer) This parameter is preset at the factory to "0" or no offset.

Follow the instructions to enter the customer access code on page 7.



When the control displays  Thermostat Set Point, press

the down arrow key  until the control display reads 



Room Temperature Offset. Press the set button .

Use the arrow keys   to adjust the offset to your desired

setting. When the display shows the offset you want press the set

button . The display will then read  Room

Temperature Offset. You can use the up or down arrow keys

  to scroll to the next parameter, or wait 30 seconds for the control to return to normal operation.

VII. p - VIEWING SENSOR TEMPERATURES:

These parameters allow a service technician or customer to view the temperature of all sensors within the unit. The temperatures cannot be adjusted.

Follow the instructions to enter the customer access code on page 7.



When the control displays  Thermostat Set Point,

press the down arrow key  until the display reads Evaporator

Coil  or Cabinet Air  or Liquid Line

 Press the SET button  to view the current sensor

value. Press the SET button when done. Press the UP or DOWN arrow

keys   to scroll through the parameters, or wait 30

seconds for the control to return to normal operation.

VIII. WIRING DIAGRAM

Note: Refer to the wiring diagram below for any service work performed by a qualified technician.

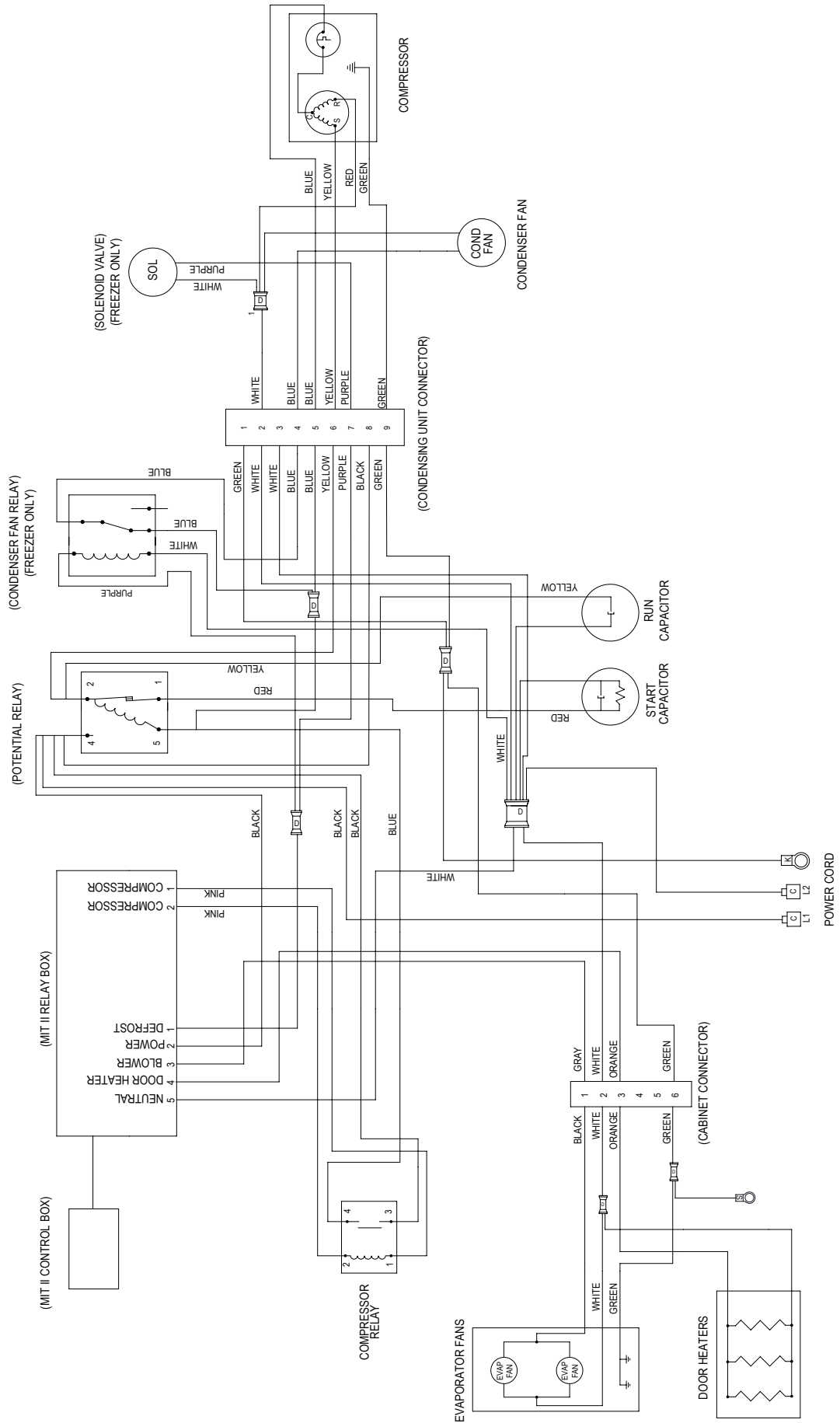

IX. TROUBLE SHOOTING GUIDE

PROBLEM	POSSIBLE SOLUTION
1. Condensing unit fails to start.	<ul style="list-style-type: none"> a. Check if cord & plug has been disconnected. b. Clean Condenser
2. Condensing unit operates for prolonged periods or continuously.	<ul style="list-style-type: none"> a. Are doors closed properly? b. Dirty condenser or filter. Clean properly. c. Evaporator coils iced. Needs to defrost. See instructions for starting a manual defrost cycle p. 10.
3. Food Compartment is too warm. (Note: Compressor may be cycling ON/OFF frequently)	<ul style="list-style-type: none"> a. Check door(s) and gasket(s) for proper seal. b. Check if a large quantity of warm food was recently added or the door was kept open for a long period of time. c. Microprocessor Control setting is too high. Readjust per instructions on p. 7 and 8. d. Clean Condenser
4. Food Compartment is too cold.	<ul style="list-style-type: none"> a. Check if a large quantity of very cold or frozen food has recently been added. Allow adequate time for the cabinet to recover its normal operating temperature. b. Adjust the microprocessor control to warmer setting. Readjust per instruction on p. 7 and 8.
5. Condensation on exterior surface.	<ul style="list-style-type: none"> a. Check door(s) alignment and gaskets for proper seal. b. Condensation on the exterior surface of the unit is perfectly normal during periods of high humidity. c. Check perimeter heat setting and increase setting if <100.
6. Product temperature in rail too warm.	<ul style="list-style-type: none"> a. Product held in plastic pans. b. Room ambient temperature exceeds 86°F. Operate in room ambient below this temperature. c. Air drafts disrupting air-flow over product pans. d. Food debris blocking air discharge and/or return vents. e. Product loaded in pans above 36°F. f. Rail inserts missing. g. Base doors left open. h. Pan(s) missing.
7. Compressor hums & does not start.	<ul style="list-style-type: none"> a. Call for service.
8. Water on floor.	<ul style="list-style-type: none"> a. Make sure drain valve is closed. b. If water is from system condensate pan, install wicking card kit.

X. SERVICE ASSISTANCE

X. a - SERVICE INFORMATION:

Before calling for service, please check the following:

Is the electrical cord plugged in?

Is the fuse OK or circuit breaker on?

Clean condenser coil

Is the power switch on?

If after checking the above items and the unit is still not operating properly, please contact an authorized Traulsen service agent. You may obtain the name of a service agent from the Service Directory page of our web site: www.traulsen.com. Please note, you will be required to register for a login name and pass code to access our directory. If service is not satisfactory, please contact our in-house service department at:

Traulsen
4401 Blue Mound Road
Fort Worth, TX 76106
(800) 825-8220

Traulsen reserves the right to change specifications or discontinue models without notice.

X. b - SERVICE SUPPORT INFORMATION:

To purchase replacement parts or to speak to service support for Traulsen and most Hobart refrigeration units please contact our Ft. Worth facility by phone at 800-825-8220 or fax to 817-740-6748 (parts) or 817-740-6757 (service).

Note: When calling for spare parts or service support, please make sure you have model and serial number of unit available.

To source service support locally follow instructions below for nearest authorized service agent. Please note, you will be required to register for a login name and pass code to access our directory.

1. Log onto www.traulsen.com
2. Select Contact Us/Dealer Directory (top right of screen)
3. Click on Service Directory tab
4. Select state by using the drop down box
5. Select Go

X. c - WARRANTY REGISTRATION:

The warranties for your new Traulsen unit may be registered with us by contacting our Ft. Worth facility directly by phone at 800-825-8220 or you may register on line. Please note, you will be required to register for a login name and pass code to access our on line registration.

1. Log onto www.traulsen.com
2. Select Contact Us/Dealer Directory (top right of screen)
3. Select Warranty Registration (lower right of screen)
4. Fill out information requested
5. Select Submit to complete unit warranty registration

XI. WARRANTIES

STANDARD DOMESTIC WARRANTY

TRAUALSEN warrants new equipment to the original purchaser, when installed within the United States against defective material and workmanship for one (1) year from the date of original installation. Under this warranty, **TRAUALSEN**, will repair or replace, at its option, including service and labor, all parts found to be defective and subject to this warranty. The compressor part is warranted for an additional four (4) years. During this period **TRAUALSEN**, will supply replacement compressor (s) if deemed defective, however, all installation, recharging and repair costs will remain the responsibility of the owner. However, all installation and repair costs will remain the responsibility of the owner.

This warranty does not apply to damage resulting from fire, water, burglary, accident, abuse, misuse, transit, acts of God, terrorism, attempted repairs, improper installation by unauthorized persons, and will not apply to food loss.

For **TRAUALSEN** units purchased with a remote feature, standard warranty will apply only to those components contained within the unit to the point of connection of the refrigeration lines leading to the remote compressor.

THERE ARE NO ORAL, STATUTORY OR IMPLIED WARRANTIES APPLICABLE TO **TRAUALSEN**, INCLUDING BUT NOT LIMITED TO, ANY IMPLIED WARRANTY OF MERCHANTABILITY OR FITNESS FOR ANY PARTICULAR PURPOSE WHICH EXTEND BEYOND THE DESCRIPTION ON THE FACE HEREOF. **TRAUALSEN** SHALL HAVE NO OBLIGATION OR LIABILITY FOR CONSEQUENTIAL OR SPECIAL DAMAGES, GROWING OUT OF OR WITH RESPECT TO THE EQUIPMENT OR ITS SALE, OPERATION OR USE, AND **TRAUALSEN** NEITHER ASSUMES NOR AUTHORIZES ANYONE ELSE TO ASSUME FOR IT ANY OBLIGATION OR LIABILITY IN CONNECTION WITH THE EQUIPMENT OR ITS SALE, OPERATION OR USE OTHER THAN AS STATED HEREIN.

PATENTED MICROPROCESSOR CONTROL WARRANTY

TRAUALSEN, warrants to the original purchaser of the microprocessor control when installed as part of the Refrigeration/Hot Food Equipment manufactured and sold by **TRAUALSEN**, to be free of defects in material and workmanship under normal service and use for a period of two (2) years from the date of installation. Under this warranty statement, **TRAUALSEN** will repair or exchange at **TRAUALSEN'S** discretion, F.O.B. factory, any part of said control, which proves to be defective. Inspection by the **TRAUALSEN** Service Department of parts claimed defective shall be final in determining warranty status. The warranty is to include repair or exchange of any defective In-Warranty control or part (s) of said control for:

Part (s) –Any **TRAUALSEN** microprocessor control supplied part (s) found to be defective.

Labor –The labor charges from a **TRAUALSEN** Certified Service Agent to effect the repair or exchange of the defective part(s).

“Defective Part Return” – All claimed defective part(s) must be returned to **TRAUALSEN** for defect validation within 30 days from the date of the repair. Failure to return all claimed defective part(s) to **TRAUALSEN** will invalidate the warranty claim, this warranty statement, and forfeit payment for those repairs effected.

This warranty does not apply to damage resulting from fire, water, burglary, accident, abuse, misuse, transit, acts of God, terrorism, attempted repairs, improper installation by unauthorized persons, and will not apply to food loss, and will not apply if said equipment is located outside The United States.

INTERNATIONAL COMMERCIAL WARRANTY

(for Canadian warranties see domestic US warranty)

TRAUALSEN warrants to the original purchaser the Refrigeration Equipment manufactured and sold by it to be free from defects in material and workmanship under normal use and service for a period of one (1) year from date of shipment. Under this warranty, **TRAUALSEN** will reimburse the purchaser for the replacement of any part of said equipment (excluding dryers & refrigerant gas) which then proves to be defective. **This warranty does not apply to damage resulting from fire, water, burglary, accident, abuse, misuse, transit, acts of God, terrorism, attempted repairs, improper installation by unauthorized persons, and will not apply to food loss.**

TRAUALSEN'S standard warranty does not apply to Export Sales. Rather, for a period of one (1) year from date of original installation not to exceed Fifteen (15) months from date of shipment from factory, **TRAUALSEN**:

Will replace, F.O.B. factory, any defective parts normally subject to warranty.

Will not cover the cost of packing, freight or labor such costs being the sole responsibility of the dealer/end user.

THIS WARRANTY IS IN LIEU OF ALL OTHER WARRANTIES EITHER EXPRESSED OR IMPLIED AND CONSTITUTES TRAUALSEN'S FULL OBLIGATION AND LIABILITY. WARRANTIES NOT AVAILABLE ON REMOTE MODELS.

XII. SERVICE PARTS LIST

Note: Part numbers listed are for standard products as currently manufactured. For products manufactured as other than standard, please contact the factory.

ITEM	DESCRIPTION	PART NUMBER
CASTERS	ALL MODELS	
	6" ADJUSTABLE CASTER NO LOCK	SER-60538-00
	6" ADJUSTABLE CASTER WITH LOCK	SER-60538-01
	4 5/8" ADJUSTABLE CASTER NO LOCK	SER-60536-00
	4 5/8" ADJUSTABLE CASTER WITH LOCK	SER-60536-01
	3 1/2" ADJUSTABLE CASTER NO LOCK	SER-60567-00
	3 1/2" ADJUSTABLE CASTER WITH LOCK	SER-60567-01
LEGS	ALL MODELS	
	6" LEG	SER-60542-00
DOORS	MODELS TS048 & TS072 (right section)	
	DOOR ASSEMBLY, HINGED LEFT	200-60791-00
	DOOR ASSEMBLY, HINGED RIGHT	200-60791-01
	DOOR GASKET	341-60197-00
DOORS	MODELS TS066, TS072 & TS090 (left section)	
	DOOR ASSEMBLY, HINGED LEFT	200-60789-00
	DOOR ASSEMBLY, HINGED RIGHT	200-60789-01
	DOOR GASKET	341-60197-02
DRAWERS	2 DRAWER 6" DEEP PAN MODELS TS048 & TS072 (right section)	
	DRAWER ASSEMBLY	550-10108-00
	DRAWER FACE ASSEMBLY	550-10114-00
	DRAWER FRAME ASSEMBLY	550-10104-00
	DRAWER FRAME INSERT	SER-60539-00
	DRAWER GASKET	341-60176-07
	DRAWER ROLLER	344-60155-00
	DRAWER ADAPTER BAR	701-61198-00
DRAWERS	2 DRAWER 6" DEEP PAN MODELS TS066, TS072 & TS090 (LEFT SECTION)	
	DRAWER ASSEMBLY	550-10190-00
	DRAWER FACE ASSEMBLY	550-10194-00
	DRAWER FRAME ASSEMBLY	550-10188-00
	DRAWER FRAME INSERT	SER-60568-00
	DRAWER GASKET	341-60176-09
	DRAWER ROLLER	344-60155-00
	DRAWER ADAPTER BAR	701-61258-00
DRAWERS	3 DRAWER 4" DEEP PAN MODELS TS048 & TS072 (RIGHT SECTION)	
	DRAWER ASSEMBLY	550-10098-00
	DRAWER FACE ASSEMBLY	550-10099-00
	DRAWER FRAME ASEMBLY	550-10104-00
	DRAWER FRAME INSERT	SER-60541-00
	DRAWER GASKET	341-60176-06
	DRAWER ROLLER	344-60155-00
	DRAWER ADAPTER BAR	701-61198-00

XII. SERVICE PARTS LIST (continued)

Note: Part numbers listed are for standard products as currently manufactured. For products manufactured as other than standard, please contact the factory.

ITEM	DESCRIPTION	PART NUMBER
DRAWERS	3 DRAWER 4" DEEP PAN MODELS TS066, TS072 & TS090 (left section)	
	DRAWER ASSEMBLY	550-10191-00
	DRAWER FACE ASSEMBLY	550-10196-00
	DRAWER FRAME ASSEMBLY	550-10188-00
	DRAWER FRAME INSERT	SER-60569-00
	DRAWER GASKET	341-60176-10
	DRAWER ROLLER	344-60155-00
	DRAWER ADAPTER BAR	701-61258-00
KEY	DOOR LOCKS (all models)	
	Key	346-28924-42
SHELVES	MODEL TS048 (3 shelves maximum per door)	
	SHELF PLATED	340-60230-01
	MODEL TS066	
	SHELF PLATED LEFT SECTION	340-60294-00
	SHELF PLATED RIGHT SECTION	340-60294-01
	MODEL TS072	
	SHELF PLATED LEFT SECTION	340-60294-00
	SHELF PLATED RIGHT SECTION	340-60231-03
	MODEL TS090	
	SHELF PLATED LEFT SECTION	340-60294-00
	SHELF PLATED RIGHT SECTION	340-60294-01
	SHELF PLATED CENTER SECTION	340-60295-00
SHELF MOUNTING PINS	ALL MODELS	
	SHELF PIN	344-24759-02
RAIL COVERS	MODEL TS048	
	HINGED LIFT UP LID	500-60722-00
	MODEL TS066	
	HINGED LIFT UP LID	500-60722-01
	MODEL TS072	
	HINGED LIFT UP LID	500-60722-02
	MODEL TS090	
	HINGED LIFT UP LID	500-60722-03
RAIL AIR BAFFLES	MODEL TS048	
	AIR BAFFLE BACK	614-60254-00
	AIR BAFFLE FRONT	614-60254-01
	1/4-20 THUMB SCREW & RETAINING RING	SER-60570-00
	MODEL TS066	
	AIR BAFFLE BACK	614-60252-02
	AIR BAFFLE FRONT	614-60252-01
	1/4-20 THUMB SCREW & RETAINING RING	SER-60570-00

XII. SERVICE PARTS LIST (continued)

Note: Part numbers listed are for standard products as currently manufactured. For products manufactured as other than standard, please contact the factory.

ITEM	DESCRIPTION	PART NUMBER
RAIL AIR BAFFLES	MODEL TS072	
	AIR BAFFLE BACK	614-60257-00
	AIR BAFFLE FRONT	614-60257-01
	1/4-20 THUMB SCREW & RETAINING RING	SER-60570-00
	MODEL TS090	
	AIR BAFFLE BACK	614-60250-02
	AIR BAFFLE FRONT	614-60250-01
	1/4-20 THUMB SCREW & RETAINING RING	SER-60570-00
RAIL ADAPTER BARS	MODELS TS048 & TS090 (models only)	
	ADAPTER BAR	701-61444-00
LOUVERS	ALL MODELS	
	LOUVER PANEL	500-60729-00
FILTERS	MODELS TS048	
	FILTER	341-60062-05
	MODELS TS066, TS072 & TS090	
	FILTER	341-60062-07
WHITE PLASTIC CUTTING BOARDS	MODELS TS048 & TS072	
	WHITE PLASTIC CUTTING BOARD	340-60172-00
	MODEL TS066	
	WHITE PLASTIC CUTTING BOARD	340-60172-02
	MODEL TS090	
	WHITE PLASTIC CUTTING BOARD	340-60172-06
COMPOSITE CUTTING BOARDS	MODELS TS048 & TS072	
	COMPOSITE CUTTING BOARD	340-60171-01
	MODELS TS066	
	COMPOSITE CUTTING BOARD	340-60171-03
	MODELS TS090	
	COMPOSITE CUTTING BOARD	340-60171-02
WICKING CARD KIT	ALL MODELS	
	WICKING CARD KIT	SER-60571-00

HOURS OF OPERATION:

Monday thru Friday 7:30 am - 4:30 pm CST



Quality Refrigeration

Traulsen
4401 Blue Moud Road Fort Worth, TX 76106
Phone (800) 825-8220 Fax (817) 740-6757
Website: www.traulsen.com