



Quality Refrigeration

OWNER'S MANUAL

Instructions For The Installation, Operation
And Maintenance Of Traulsen
TE-Series Refrigerated Equipment Stand Models:

* Traulsen's equipment stands are solely intended for use with cooking equipment.

- 2-Drawer Models TE036HT, TE048HT & TE060HT
- 4-Drawer Models TE065HT, TE072HT & TE084HT
- 6-Drawer Models TE096HT, TE110HT & TE125HT
- 8-Drawer Model TE139HT



This Traulsen unit is built to our highest quality standards. We build our refrigerators this way as a matter of pride. This philosophy has made Traulsen the leader in commercial refrigeration since 1938. We thank you for your choice and confidence in Traulsen equipment and we know you will receive many years of utility from this equipment.

All Traulsen units are placed on a permanent record file with the service department. In the event of any future questions you may have, please refer to the model and serial number found on the name tag affixed to the unit. Should you need service, call us on our toll free number, 800-825-8220 between 7:30 am - 4:30 pm CST, Monday thru Friday. You may also log onto www.traulsen.com for further information. It is our pleasure to help and assist you in every possible way.

INSTALLER	
COMPLETE THE FOLLOWING INFORMATION PRIOR TO UNIT INSTALLATION	
INITIAL START DATE: _____	SERIAL NO. _____
MODEL TYPE: _____	
COMPANY/INDIVIDUAL NAME: _____	
INSTALLER: _____	

TABLE OF CONTENTS

I. THE SERIAL TAG	Page 1	i-Changing The Temperature Scale	Page 10
II. RECEIPT INSPECTION	Page 2	j-Setting The 24-Hour Clock	Page 11
III. INSTALLATION		k-Setting The Date	Page 12
a-Location	Page 2	l-Setting Daylight Savings Time	Page 12
b-Packaging	Page 2	m-Starting A Manual Defrost	Page 13
c-Adjusting the Casters	Page 2	n-Setting Defrost Lockouts	Page 14
d-Cord & Plug	Page 2	o-Adjusting The Drawer Perimeter Heaters	Page 15
e-Power Supply	Page 2	p-Adjusting The Room Temperature Offset	Page 15
f-Placing Equipment On Top Of Unit	Page 3	q-Setting The Audible Alarm Style	Page 16
IV. OPERATION		r-Viewing Sensor Temperatures	Page 16
a-Refrigerators	Page 3	VIII. WIRING DIAGRAM	Page 17
V. CARE & MAINTENANCE		IX. TROUBLE SHOOTING GUIDE	Page 18
a-Cleaning The Condenser/Filter	Page 3	X. SERVICE ASSISTANCE	
b-Replacing The Gaskets	Page 4	a-Service Information	Page 19
c-Cleaning The Cabinet Surface	Page 4	b-Spare Parts Information	Page 19
VI. DRAWERS		c-Warranty Registration	Page 19
a-Removing The Drawers And Frame Module	Page 4	XI. WARRANTIES	Page 20
VII. MICROPROCESSOR CONTROL		XII. SERVICE PARTS LIST	Page 21
a-Control Features	Page 5		
b-Alarm Explanations	Page 6		
c-Control Panel Diagram	Page 7		
d-Notes To The User	Page 7		
e-Enter The Service Access	Page 8		
f-Service Parameters	Page 9		
g-Adjusting Thermostat Set Point High	Page 9		
h-Adjusting Thermostat Set Point Low	Page 10		



FORT WORTH, TX.

SERIAL		MODEL	
VOLTS	Hz		PH
TOTAL CURRENT		AMPS	
MINIMUM CIRCUIT	AMPS		
MAXIMUM OVERCURRENT PROTECTION			AMPS
LIGHTS	WATTS		
HEATERS	AMPS		
REFRIGERANT		TYPE	OZ
DESIGN PRESSURE		HIGH	LOW
REFRIGERANT		TYPE	OZ
DESIGN PRESSURE		HIGH	LOW

370-60294-00 REV (A)



I. THE SERIAL TAG

The serial tag is a permanently affixed label on which is recorded vital electrical and refrigeration data about your Traulsen product, as well as the model and serial number. This tag is located in the right interior compartment on all standard Equipment Stand models.

READING THE SERIAL TAG

- Serial = The permanent ID# of your Traulsen unit
- Model = The model # of your Traulsen unit
- Volts = Voltage
- Hz = Cycle
- PH = Phase
- Total Current = Maximum amp draw
- Minimum Circuit = Minimum circuit ampacity
- Lights = Light wattage
- Heaters = Heater amperage (Hot Food units only)
- Refrigerant = Refrigerant type used
- Design Pressure = High & low side operating pressures and refrigerant charge
- Agency Labels = Designates agency listings

II. RECEIPT INSPECTION

All Traulsen products are factory tested for performance and are free from defects when shipped. The utmost care has been taken in crating this product to protect against damage in transit.

You should carefully inspect your Traulsen unit for damage during delivery. If damage is detected, you should save all the crating materials and make note on the carrier's Bill Of Lading describing the damage. A freight claim should be filed immediately. If damage is subsequently noted during or immediately after installation, contact the respective carrier and file a freight claim. There is a fifteen (15) day limit to file freight damage with the carrier. Under no condition may a damaged unit be returned to Traulsen without first obtaining written permission (return authorization). You may contact Hobart/Traulsen customer care at 800-333-7447 to request a return.

III. INSTALLATION

III. a - LOCATION:

Unit must be placed on leveled floor for proper usage.

III. b - PACKAGING:

Your Traulsen unit is shipped from the factory packaged with stretch wrap material.

Most exterior stainless steel surfaces have a protective blue vinyl covering to prevent scratching during manufacturing, shipping and installation. After the unit is installed in place of application peel, remove and discard the covering from all surfaces.

The equipment stands are shipped on a skid that is designed to allow a unit to be slid off the skid onto the factory installed casters. When a unit is being removed from the skid two or more runners will act as slides and will remain with the unit while it is being removed. These runners prevent damage to the machine when it drops off the skid to the floor.

To unload the machine, remove the exterior packaging.

Next, remove the bolts that attach the skid to the machine as shown in (A).

Finally, push the machine off the skid keeping the length of the machine parallel to the skid's 4x4 pieces. On longer machines this may require two or more individuals.

III. INSTALLATION (continued)

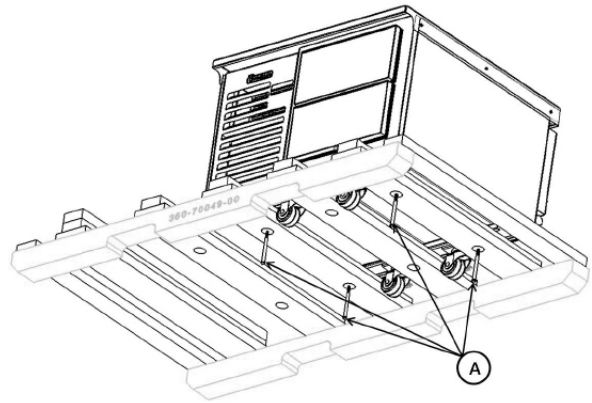

NOTE: Traulsen does not recommend laying the unit on its front, side or back. If you must, please allow the unit to remain in an upright position for 24 hours before plugging it in so that the compressor oils and refrigerant may settle.

III. c - ADJUSTING THE CASTERS:

To adjust the caster loosen the two bolts and move caster to desired location, spacing between casters not to exceed 48 inches. Casters on each end of the unit can not exceed 8 inches from the end of the cabinet.

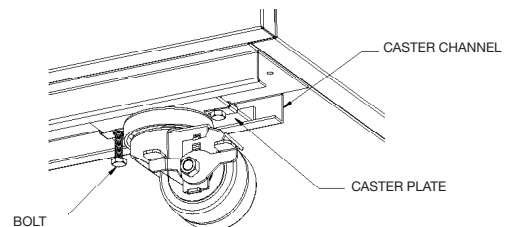

III. d - CORD & PLUG:

All self-contained models are shipped standard with a NEMA 5-15P plug and 9 foot cord and spring retainer attached at the rear of the cabinet. Select only a dedicated electrical outlet for power source.

NOTE: Do not under any circumstances, cut or remove the round grounding prong from the plug, or use an extension cord.

III. e - POWER SUPPLY:

The supply voltage should be checked prior to connection to be certain that proper voltage for the cabinet wiring is available (refer to the serial tag to determine correct unit voltage). Make connections in accordance with local electrical codes. Use qualified electricians.

Use of a separate, dedicated circuit is required. Size wiring to handle indicated load and provide necessary overcurrent protector in circuit (see amperage requirements on the unit's serial tag).

III. INSTALLATION (continued)

II. f - PLACING EQUIPMENT ON TOP OF UNIT:

Equipment may be placed on top of your Traulsen equipment stand. A stainless steel worktop, provided standard is required on cabinets being used to support equipment weighing in excess of 100 lbs. or producing heat in excess of 140°F to the top surface. Refer to below chart to determine Maximum Top Load Capacity for your unit.

Model	Max Top Load Capacity lbs.
TE036HT	625
TE048HT	625
TE060HT	1200
TE065HT	1200
TE072HT	1200
TE084HT	1500
TE096HT	1500
TE110HT	1500
TE125HT	2000
TE139HT	2000

IV. OPERATION

IV. a - REFRIGERATORS:

Refrigerators do not require manual defrosting. During normal operation, a refrigerator continuously circulates above freezing cabinet air through the coil. A compressor "OFF" cycle occurs every 2 1/2 Hours for 20 minutes to melt any frost which may accumulate on the coil during the compressor "ON" cycle. The control will read "dEF" and the green water drop will be illuminated. With standard holding refrigerators, high relative humidity is also maintained to prevent dehydration of stored product.



V. CARE & MAINTENANCE

V. a - CLEANING THE CONDENSER/FILTER:

The most important thing you can do to insure a long, reliable service life for your Traulsen is to regularly clean the condenser coil and or filter if provided.

The microprocessor control will notify you through a "CLN-FIL" message when the condensing temperature of the refrigerator reaches 140 degrees F or greater. If the condensing temperature reaches 160 degrees F the compressor will automatically turn off. When the temperature drops below 140 degrees F the compressor will restart and when the temperature drops below 120 degrees F the alarm will reset.

WARNING: DISCONNECT ELECTRICAL POWER SUPPLY BEFORE CLEANING ANY PARTS OF THE UNIT.

To clean the condenser/filter, first disconnect electrical power to the cabinet and remove the front louver assembly. To do so, place hands under the louver panel and pull out and up to get louver panel off bracket of the unit. See diagram below.

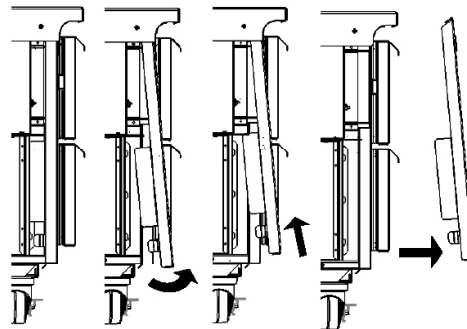

Proceed to vacuum or brush any dirt, lint or dust from the finned condenser coil/filter, the compressor and other cooling system parts. If significant dirt is clogging the condenser fins or filter, use compressed air to blow this clear.

To replace the louver assembly reverse the process.

V. CARE & MAINTENANCE-(continued)

V. b - REPLACING THE GASKETS:

To remove the gasket to be replaced, grasp it firmly by one corner and pull it out. Before attempting to install a new gasket, both the unit and the gasket itself must be at room temperature. Insert the four corners first by using a rubber mallet (or hammer with a block of wood). After the corners are properly inserted, work your way towards the center from both ends by gently hitting with a mallet until the gasket is completely seated in place (see figure 5 for proper gasket placement).

NOTE: The gasket may appear too large, but if it is installed as indicated above it will slip into place.

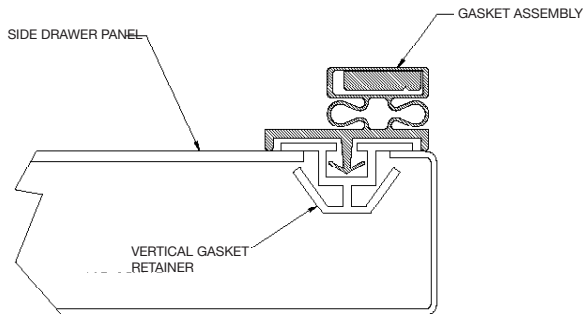

Fig. 5

V. c - CLEANING THE CABINET SURFACES:

WARNING: DISCONNECT ELECTRICAL POWER SUPPLY BEFORE CLEANING ANY PARTS OF THE UNIT.

Exterior stainless steel should be cleaned with warm water, mild soap and a soft cloth. Apply with a dampened cloth and wipe in the direction of the metal grain.

Avoid the use of strong detergents and gritty, abrasive cleaners as they may tend to mar and scratch the surface. Do NOT use cleansers containing chlorine, such as bleach, this may promote corrosion of the stainless steel.

Care should also be taken to avoid splashing the unit with water, containing chlorinated cleansers, when mopping the floor around the unit.

For stubborn odor or spills, use baking soda and water (mixed to a 1 tbsp baking soda to 1 pint water ratio).

A stainless steel polish is recommended for shining of unit.

VI. DRAWERS

VI. a - REMOVING THE DRAWERS AND FRAME MODULE:

Remove the drawer (s) from the drawer frame by lifting up on the drawer and pull out.

Once the drawer(s) have been removed, the drawer frame module can also be removed by loosening the black front and back clamping knobs (2 of each) located on the cross rail locks and liner locks. Slide the front cross rail locks towards the center of the drawer frame module and allow the liner locks to drop down from the top of the liner. Pull the door frame module forward, tip forward and pull out. The entire frame assembly is now free to slide out of the cabinet.

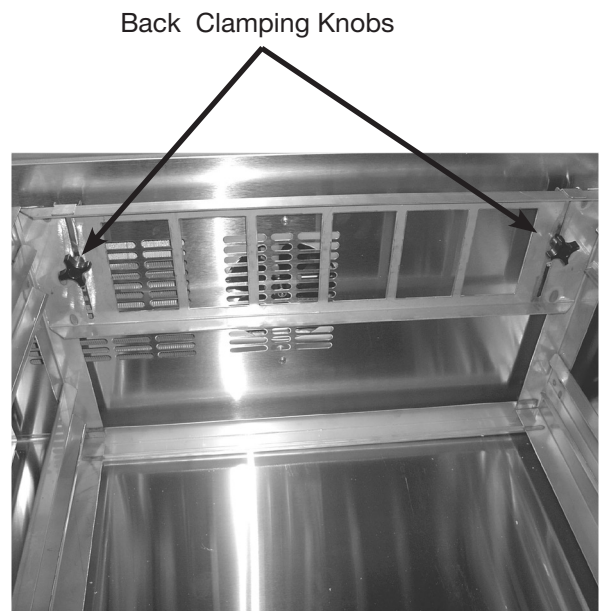
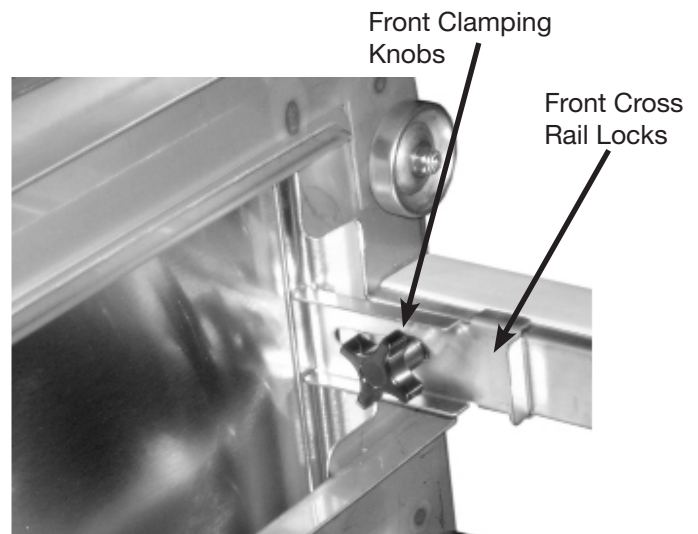

VII. MICROPROCESSOR CONTROL

Your new refrigerator cabinet is equipped with a state-of-the-art microprocessor control, which precisely regulates operation and provides alarms when problems occur. It is supplied from the factory completely ready for use and requires no adjustments, but without the audible alarms activated. See pages 6 thru 16 for more information.

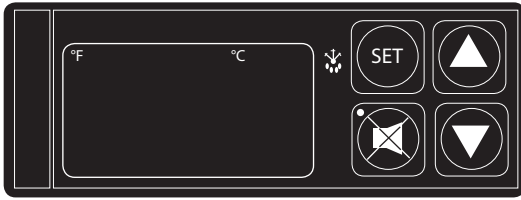

MICROPROCESSOR CONTROL

VII. a - CONTROL FEATURES:

1- Internal Time Clock

- Eliminates external defrost time clock.
- Defrost cycle can be quickly adjusted to suit individual location and use.
- Must be set at power-up. (See page 11, "Setting the 24-Hour Clock")
- Will automatically update for Daylight Savings Time.

2- Water Resistant Housing - The face of the control is water resistant to provide for protection during cleaning.

3- Parameter/Service Levels

- See "Customer / Service Parameters" on Page 9.

4- Defrost Lockouts - See "Setting Defrost Lockouts" on page 14.

Customers can set up to 4 different defrost lockout periods. The lockout prevents the unit from going into a defrost cycle during peak kitchen use. Note: The 24-hour clock must be set for this feature to operate correctly.

5- Communication Ability - A NAFEM Data Protocol (NDP) compliant RS-485 serial communications port is available to interface with data collection software (by others). All microprocessor control equipped models are capable of communicating within a NAFEM Data Protocol network if provided with an optional Gateway Hub (available from Traulsen). The actual communications software is available from a number of third party software vendors.

6- Anti-Condensate Door Perimeter Heater Control

The "No-Sweat" feature is an energy savings system that allows the customer to adjust the percent of time for the drawer heater to be "On" as needed for the prevailing ambient conditions (from 0 - 100% of the time each day). It is used to prevent condensation from forming around the perimeter of the drawers. The factory default setting is 100%. Adjust this set point down to a point just before condensation forms to save energy.

7- Alarms (See the following pages for explanations)

- High Cabinet Air Temperature
- Low Cabinet Air Temperature
- Loss Of Power
- Sensor Failure
- Clean Condenser

8- Display Features

- 3-Digit LED Display
- Defrost in Progress Icon
- Fahrenheit or Celsius Temperature Scale In Use

VII. MICROPROCESSOR CONTROL (continued)

VII. b - ALARM EXPLANATIONS:

*NOTE: Explanation of alarms assume the audible alarm style is set at a 3-second burst or a continuous audible alarm. References to the audible alarm do not apply if the audible alarm style is set to OFF (Refer to page 16 for setting the audible alarm style).

The display shows the text "HI CAB" in a segmented font. "HI" is on the left and "CAB" is on the right.

High Cabinet Air Temperature: The audible alarm will sound and the display will read HI CAB when the temperature inside the cabinet rises above a pre-programmed limit. The limit is determined by the type of unit being operated (i.e.: refrigerator/freezer). To turn off the audible alarm, press the alarm cancel button. The visual alarm text will continue to display until the cabinet air temperature falls below the limit. If the temperature does not fall below the limit within 5 minutes, the audible alarm* will sound again and an additional Call Service message will display.

POSSIBLE CAUSES:

- Drawers open for extended periods of time.
- Large amounts of hot product placed inside the cabinet.
- Condenser coil dirty.

The display shows the text "Lo CAB" in a segmented font. "Lo" is on the left and "CAB" is on the right.

Low Cabinet Air Temperature: The audible alarm will sound and the display will read Lo Cab when the temperature inside the cabinet falls below a pre-programmed limit. The limit is determined by the type of unit being operated (i.e.: refrigerator/ freezer). To turn off the audible alarm, press the alarm cancel button. The visual alarm text will continue to display until the cabinet air temperature rises above the limit. If the temperature does not rise above the limit within 5 minutes, the audible alarm will sound again and an additional Call Service message will display.

POSSIBLE CAUSES:

- No product in unit.
- Failed sensors.

The display shows the text "ELE LOS" in a segmented font. "ELE" is on the left and "LOS" is on the right.

Loss Of Power: The audible alarm will sound and the display will read ELE LOS, when the unit regains power after an outage. To turn off the audible alarm and/or clear the visual text, press the alarm cancel button.

The display shows the text "ClnFIL" in a segmented font. "Cln" is on the left and "FIL" is on the right.

Condenser Clean: The audible alarm will sound and the display will read "Clean Filter" when discharge temperatures exceeds 140 degrees. As the load on the condenser decreases, the alarm will turn off by itself. As the temperature on the condenser continue to rise, the audible alarm will return until the problem has been eliminated.

The display shows the text "CAB Senr" in a segmented font. "CAB" is on the left and "Senr" is on the right.The display shows the text "COL Senr" in a segmented font. "COL" is on the left and "Senr" is on the right.The display shows the text "dis Senr" in a segmented font. "dis" is on the left and "Senr" is on the right.

Sensor Failures:

The audible alarm will sound and the display will read CAB SEN, COL SEN or DIS SEN when that particular sensor has failed to operate. To turn off the audible alarm, press the alarm cancel function of the sensor, the audible alarm will sound again in either 5 minutes or 24 hours.

VII. MICROPROCESSOR CONTROL (continued)

VII. c - CONTROL PANEL DIAGRAM:

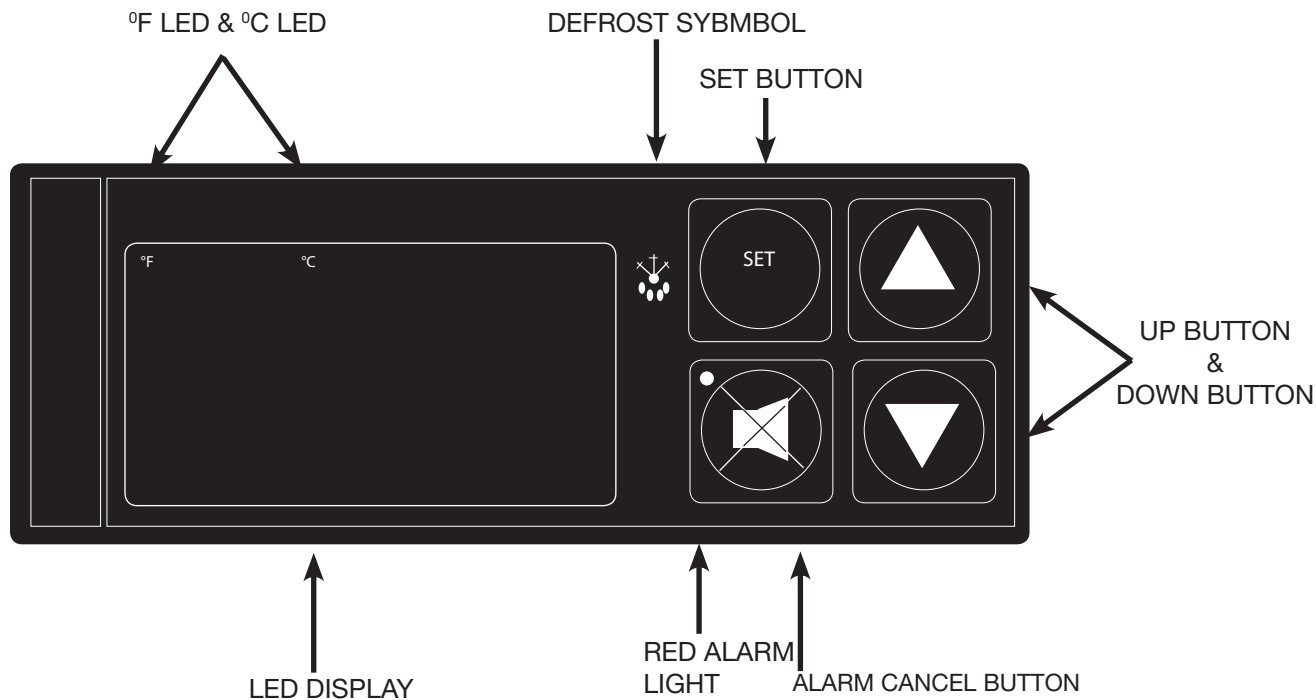



VII. d - NOTES TO THE USER:

You only have 20-30 seconds between button pushes. If you take longer than 30 seconds, the controller will revert back to displaying the cabinet temperature. If you enter the wrong security code, the controller will revert back to displaying the cabinet temperature. You can exit the parameters at any time by pressing the alarm cancel button or by waiting 20-30 seconds.

VII. MICROPROCESSOR CONTROL (continued)

VII. e - ENTER THE SERVICE ACCESS:

Use the security code 0, A, 1  and the following instructions:

Press the set button . The display will read  Service Access.

Press the set button .

The display will show three zeros with the left zero flashing 

Press the set button .

The display will show three zeros with the center zero flashing 



Press the down arrow key  to sequence through F, E, d, C, b, A, 9, 8, 7,...etc.

When you reach A press set .

The display will show zero, A, zero with the right zero flashing 

Press the up arrow key  to sequence through 1, 2, 3, 4, 5, 6, 7, 8, 9, A, b,...etc.

When you reach 1 press set .

The display will read  Thermostat Set Point High. Press  to view and  again to exit.

You are now in the SERVICE PARAMETERS.

VII. MICROPROCESSOR CONTROL (continued)

VII. f - SERVICE PARAMETERS:

Listed below are the available parameters in the order they appear, using the down arrow key on the controller. You can use either the up or down arrow keys to scroll through the options.

Thermostat Set Point High

Defrost Lockout 3

Thermostat Set Point Low

Defrost Lockout 4

Temperature Scale

Dew Point Compensation Factor

Time (24-hour clock)

Room Temperature Offset

Date (month-day-year)

Audible Alarm Style

Daylight Savings

Cabinet Air Sensor Temp

Start Manual Defrost

Evaporator Coil Sensor

Defrost Lockout 1

Discharge Line Sensor

Defrost Lockout 2

VII. g - ADJUSTING THERMOSTAT SET POINT HIGH:

This parameter sets the high point of the desired cabinet temperature range. Typically, freezers will range from -3° F to 0° F (-19° C to -18° C) and refrigerators will range from 36° F to 40° F (2° C to 4° C) for this parameter setting. This parameter is preset at the factory and does not have to be adjusted unless the customer chooses to do so. Note: Set Point Low and Set Point High cannot be set to the same temperature. There must be at least 1-2 degree difference between the two settings.

Follow the instructions to enter the customer access code on page 8. When the control

display reads Thermostat Set Point High. Press the set button .

Use the arrow keys to adjust the temperature to your desired setting.

When the display shows the temperature you want press the set button .

The display will then read Thermostat Set Point High.

You can use the up or down arrow keys to scroll to the next parameter .



or press the alarm cancel button to exit .

VII. MICROPROCESSOR CONTROL (continued)



VII. h - ADJUSTING THERMOSTAT SET POINT LOW:

This parameter sets the low point of the desired cabinet temperature range. Typically, freezers will range from -6°F to -4°F (-21°C to -20°C) and refrigerators will range from 32°F to 34°F (0°C to 1°C) for this parameter setting. This parameter is preset at the factory and does not have to be adjusted unless the customer chooses to do so. Note: Set Point Low and Set Point High cannot be set to the same temperature. There will be at least 1-2 degree difference between the two settings.

Follow the instructions to enter the service access code on page 8. When the control



displays  Thermostat Set High, press the down arrow key  until the control

display reads  Thermostat Set Point Low. Press the set button .

Use the arrow keys   to adjust the temperature to your desired setting.

When the display shows the temperature you want press the set button .

The display will then read  Thermostat Set Point Low.

You can use the up or down arrow keys to scroll to the next parameter  



or press the alarm cancel button to exit .



VII. i - CHANGING THE TEMPERATURE SCALE:

The temperature scale determines if the temperature displayed will be in degrees



Fahrenheit or degrees Celsius.

Follow the instructions to enter the customer access code on page 8. When the control

displays  Thermostat Set High, press the down arrow key  until the control

display reads  Temperature Scale. Press the set button .

The display will start with the current setting either  for degrees Fahrenheit

or  for degrees Celsius. Use the arrow keys   to toggle between the options.

When the display shows the scale you want press the set button .

The display will then read  Temperature Scale.

You can use the up or down arrow keys   to scroll to the next parameter

or press the alarm cancel button to exit .



VII. MICROPROCESSOR CONTROL (continued)



VII. j - SETTING THE 24-HOUR CLOCK:

The internal time clock must be set in order for the data storage memory to correctly log events and to allow any defrost lockout to occur at the correct time of day. If the clock is not set, the control assumes the time is 12 am at the time power is supplied to the unit. The hours on a 24-hour time clock read the following way:

H01 = 1:00 a.m.	H07 = 7:00 a.m.	H13 = 1:00 p.m.	H19 = 7:00 p.m.
H02 = 2:00 a.m.	H08 = 8:00 a.m.	H14 = 2:00 p.m.	H20 = 8:00 p.m.
H03 = 3:00 a.m.	H09 = 9:00 a.m.	H15 = 3:00 p.m.	H21 = 9:00 p.m.
H04 = 4:00 a.m.	H10 = 10:00 a.m.	H16 = 4:00 p.m.	H22 = 10:00 p.m.
H05 = 5:00 a.m.	H11 = 11:00 a.m.	H17 = 5:00 p.m.	H23 = 11:00 p.m.
H06 = 6:00 a.m.	H12 = 12:00 p.m.	H18 = 6:00 p.m.	H24 = 12:00 a.m.

Follow the instructions to enter the customer access code on page 8. When the control

displays  Thermostat Set High, press the down arrow key  until the control



display reads  Clock. Press the set button .

The display will show  Hours. The right two numbers will be flashing.

Use the arrow keys   to set the hour.

When the correct hour is displayed, press the set button .

The display will show  minutes. The right two numbers will be flashing.

Use the arrow keys to set the minutes  .

When the correct minutes are displayed, press the set button .

The display will then read  clock.

You can use the up or down arrow keys   to scroll to the next parameter

or press the alarm cancel button to exit .



VII. MICROPROCESSOR CONTROL (continued)



VII. k - SETTING THE DATE:



The date must be set in order for the data storage memory to correctly log events. Follow the instructions

to enter the service access code on page 8. When the control displays  Thermostat Set Point



High, press the down arrow key  until the control display reads  Date. Press the set



button . The display will show  (year). The right two numbers will be flashing. Press the

arrow keys   to set the year. When the correct year is displayed, press the set button .

The display will show  (month). The right two numbers will be flashing. Use the arrow keys  

to set the month. When the correct month is displayed, press the set button . The display will

show  (day). The right two numbers will be flashing. Press the arrow keys   to

set the day. When the correct day is displayed, press the set button . The display will then read 



Date. You can use the up or down arrow keys   to scroll to the next parameter, press the alarm



cancel button to exit .

VII. l - SETTING DAYLIGHT SAVINGS TIME:



This parameter is preset at the factory to automatically adjust the 24-hour clock for Daylight Savings

Time. Follow the instructions to enter the customer access code on page 8. When the control displays  Thermostat Set Point High,



press the down arrow key  until the display reads  Daylight

Savings Time. Press the set button . The display will show  Daylight Savings Time (Yes,

automatically adjust for Daylight Savings Time). For “YES” press the set button , for “NO” press

the up or down arrow key  . The display will read  Daylight Savings Time (no).



Press the set button . The display will read  Daylight Savings Time. You can press the

up or down arrow keys   to scroll to the next parameter or press the alarm cancel button to

exit .

VII. MICROPROCESSOR CONTROL (continued)

VII. m - STARTING A MANUAL DEFROST CYCLE:

This parameter allows a service technician to start a defrost cycle at any time. This parameter will override any lockout settings. Follow the instructions to enter the customer access code on page 8. When the control displays  Thermostat Set High, press the down arrow key  until the control display reads  Start Manual Defrost.

Press the set button



The display will show



Press either arrow key



(YES)

The display will show



Press the set button



DEFROST ICON



The defrost icon will be lit, and the display will read  when the unit is in defrost.

NOTE: Traulsen refrigerator units also have an off-cycle defrost, at which time the control will read 

This defrost is temperature terminated and can last from 3 - 20 minutes (dEF will be displayed for 20-37 minutes time).

VII. MICROPROCESSOR CONTROL (continued)

VII. n - SETTING THE DEFROST LOCKOUTS:

The defrost lockout parameters allow the customer to prevent the unit from going into a defrost cycle for two hours during a set time frame. Customers can set up to four defrost lockout parameters. They are all programmed the same way. The parameters will be set for the time the lockout is to start. The controller automatically calculates 2 hours from that setting. The options are similar to the 24-hour clock settings and are in 30-minute increments. Each of the lockout parameters covers 6 hours of the 24-hour clock. Note: The 24-hour clock must be set for this feature to operate at the correct time of day. See "Setting the 24-Hour Clock" on page 11.

Sample:

243

dL1

OFF

020 = 2:00 a.m.
023 = 2:30 a.m.
030 = 3:00 a.m.
033 = 3:30 a.m.
040 = 4:00 a.m.
043 = 4:30 a.m.
050 = 5:00 a.m.
053 = 5:30 a.m.
060 = 6:00 a.m.
063 = 6:30 a.m.
070 = 7:00 a.m.
073 = 7:30 a.m.
080 = 8:00 a.m.

dL2

OFF

080 = 8:00 a.m.
083 = 8:30 a.m.
090 = 9:00 a.m.
093 = 9:30 a.m.
100 = 10:00 a.m.
103 = 10:30 a.m.
110 = 11:00 a.m.
113 = 11:30 a.m.
120 = 12:00 p.m.
123 = 12:30 p.m.
130 = 1:00 p.m.
133 = 1:30 p.m.
140 = 2:00 p.m.

dL3

OFF

140 = 2:00 p.m.
143 = 2:30 p.m.
150 = 3:00 p.m.
153 = 3:30 p.m.
160 = 4:00 p.m.
163 = 4:30 p.m.
170 = 5:00 p.m.
173 = 5:30 p.m.
180 = 6:00 p.m.
183 = 6:30 p.m.
190 = 7:00 p.m.
193 = 7:30 p.m.
200 = 8:00 p.m.

dL4



OFF

200 = 8:00 p.m.
203 = 8:30 p.m.
210 = 9:00 p.m.
213 = 9:30 p.m.
220 = 10:00 p.m.
223 = 10:30 p.m.
230 = 11:00 p.m.
233 = 11:30 p.m.
240* = 12:00 a.m.
243* = 12:30 a.m.
010 = 1:00 a.m.
013 = 1:30 a.m.
020 = 2:00 a.m.



* Denotes not available.

A lockout can not be programmed to start at 12:00 am or 12:30 am due to conflicts with other internal programs. The defrost lockouts can not be programmed to run back-to-back. For example, if dL1 is set to 080, then a defrost cycle would be locked out from 8:00 am to 10:00 am. Because of the dL1 setting the dL2 parameter would not let the user choose a lockout start time before 10:30 am. All lockouts are preset at the factory to OFF.

Follow the instructions to enter the customer access code on page 9. When the control

displays  Thermostat Set High, press the down arrow key  until the control the

control display reads    or . Press the set button .

The display will show  Off. Press the arrow keys   to set the start time.

When the correct time is displayed, press the set button .

The display will then read    or .











You can press the up or down arrow keys   to scroll to the next parameter

or press the alarm cancel button to exit .

VII. MICROPROCESSOR CONTROL (continued)











VII. o - ADJUSTING THE DRAWER PERIMETER HEATERS:

This parameter allows the customer to turn ON and OFF the anti-condensate drawer perimeter heaters. This parameter is set to the highest setting (100) at the factory so that the drawer heaters stay on continuously. If you choose to have the drawer heaters cycle on and off, lower this parameter to approximately 30. If condensation forms around the drawers, increase the parameter until condensation stops. The exact setting will vary depending on ambient conditions.

Follow the instructions to enter the customer access code on page 8. When the control displays  Thermostat Set High, press the down arrow key  until the control display reads  DewPoint Compensation Factor. Press the set button . Press the arrow keys   to adjust the factor to your desired setting. When the display shows the factor you want press the set button . The display will then read  DewPoint Compensation Factor. You can use the up or down arrow keys   to scroll to the next parameter or press the alarm cancel button to exit .

VII. p - ADJUSTING THE ROOM TEMPERATURE OFFSET:

The room temperature offset parameter allows a service technician or end user the ability to have the display show a temperature that is within three degrees of the actual temperature being read by the cabinet air sensor. This allows for continuity of reading between different temperature reading devices. (i.e.: thermistor vs. thermocouple vs. handheld thermometer) This parameter is preset at the factory to “-2.5°F”.















Follow the instructions to enter the customer access code on page 8. When the control displays  Thermostat Set High, press the down arrow key  until the control display reads  Room Temperature Offset. Press the set button . Use the arrow keys   to adjust the offset to your desired setting. When the display shows the offset you want press the set button . The display will then read  Room Temperature Offset. You can use the up or down arrow keys   to scroll to the next parameter or press the alarm cancel button to exit .

VII. MICROPROCESSOR CONTROL (continued)

VII. q - SETTING THE AUDIBLE ALARM STYLE:









These parameters will allow the customer to turn on/off the audible alarm feature on the INTELA-TRAUL® control. The audible alarm is preset from the factory to OFF. The customer can choose between an audible alarm that sounds for 3 seconds then automatically turns off, or a continuous audible alarm that must be manually acknowledged. Regardless of this feature's setting, visual alarm text will display when conditions warrant.

To adjust this setting, follow the instructions to enter the customer access code on page 8. When the control displays

 Thermostat Set Point High, press the up arrow key  until the display reads  Audible Alarm Style. Press the set button . The display will read  OFF. Use the arrow keys   to scroll between  for the 3-Second Audible Alarm Burst or  for Continuous Audible Alarm. When the display shows your choice of style, press the set button . The display will then read  thermostat Set Point High. Use the arrow keys   to scroll to the next parameter or press the Alarm Cancel Button  to exit.

VII. r - VIEWING SENSOR TEMPERATURES:

These parameters allow a service technician or customer to view the temperature of all sensors within the unit. The temperatures cannot be adjusted.

Follow the instructions to enter the customer access code on page 8. When the control displays Thermostat Set Point High  press the up arrow key  until the display reads Evaporator Coil Sensor  or Discharge Line Sensor  or press the SET button . The display will read the temperature of the designated sensor. Press the UP or DOWN arrow keys   to scroll through the parameters or press the ALARM CANCEL button  to exit.

VIII. WIRING DIAGRAM

Note: Refer to the wiring diagram below for any service work performed by a qualified technician.

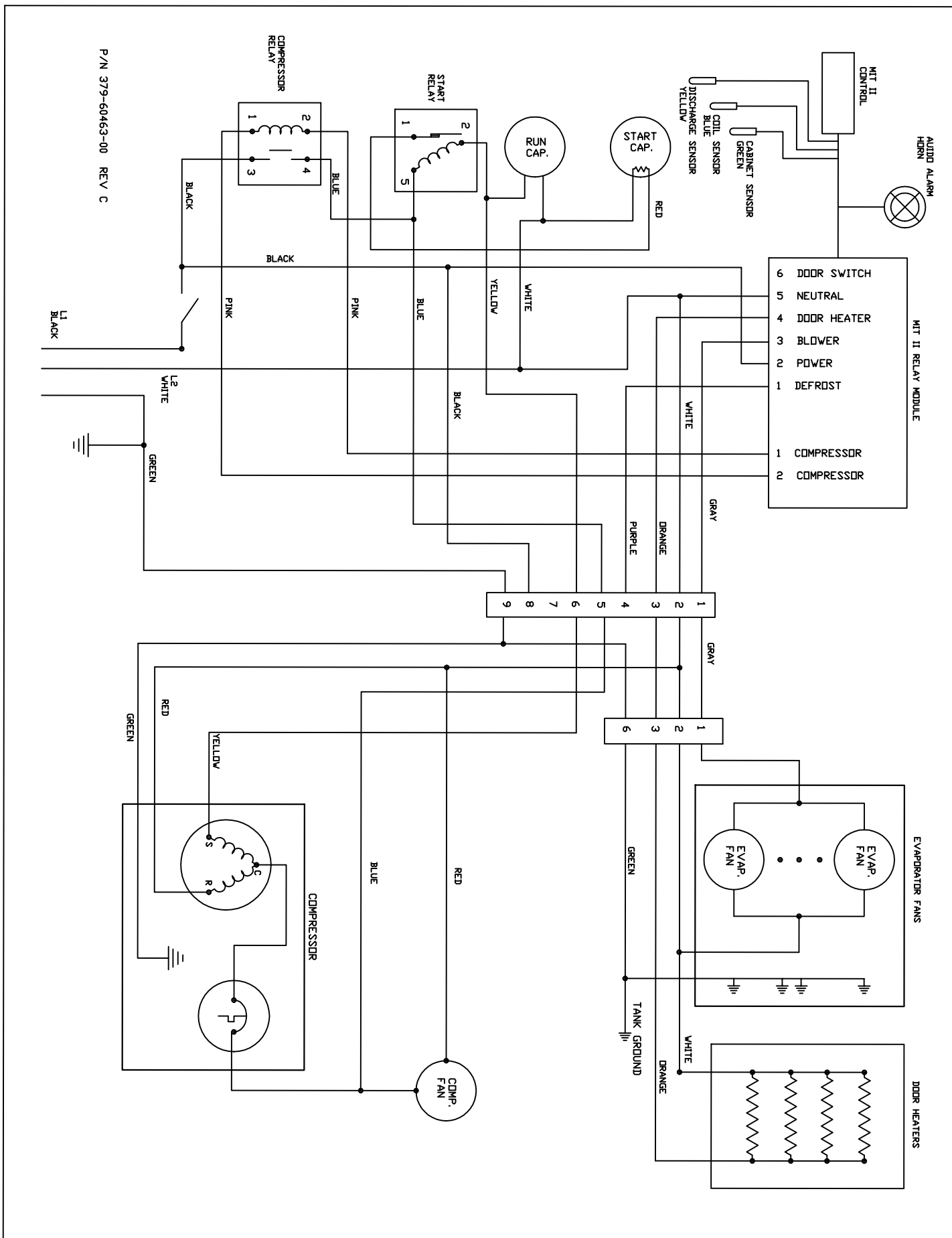

IX. TROUBLE SHOOTING GUIDE

PROBLEM	POSSIBLE SOLUTION
1. Condensing unit fails to start.	a. Check if cord & plug has been disconnected.
2. Condensing unit operates for prolonged periods or continuously.	a. Are drawers closing properly? b. Dirty condenser or filter. Clean properly. c. Evaporator coils iced. Needs to defrost. See instructions for setting a manual defrost cycle p. 13.
3. Food Compartment is too warm.	a. Check drawer (s) and gasket (s) for proper seal. b. Check if a large quantity of warm food was recently added or the door was kept open for a long period of time. c. Microprocessor Control setting is too high. Readjust per instructions on p. 9 and 10.
4. Food Compartment is too cold.	a. Check if a large quantity of very cold or frozen food has recently been added. Allow adequate time for the cabinet to recover its normal operating temperature. b. Adjust the microprocessor control to warmer setting. Readjust per instruction on p. 9 and 10.
5. Condensation on exterior surface.	a. Check drawer (s) alignment and gaskets for proper seal. b. Condensation on the exterior surface of the unit is perfectly normal during periods of high humidity. c. Check perimeter heat setting and increase setting if <100 (see section VII).
6. Compressor hums & does not start.	a. Call for service.

X. SERVICE ASSISTANCE

X. a - SERVICE INFORMATION:

Before calling for service, please check the following:

Is the electrical cord plugged in?

Is the fuse OK or circuit breaker on?

Clean condenser coil

Is the power switch on? (See XI f. for switch location)

If after checking the above items and the unit is still not operating properly, please contact an authorized Traulsen service agent. A complete list of authorized service agents was provided along with your Traulsen unit. If you cannot locate this, you may also obtain the name of a service agent from the Tech Service page of our website: www.traulsen.com. If service is not satisfactory, please contact our in-house service department at:

Traulsen
4401 Blue Mound Road
Fort Worth, TX 76106
(800) 825-8220

Traulsen reserves the right to change specifications or discontinue models without notice.

X. b - SPARE PARTS INFORMATION:

To purchase replacement parts or to speak to service support for Traulsen and most Hobart Refrigeration units please contact our Ft. Worth facility by phone at 800-825-8220 or fax to 817-740-6748 (parts) or 817-740-6757 (service).

To source parts locally follow instructions below for nearest location:

1. Log onto www.traulsen.com
2. Select Service Directory (top of screen)
3. Select Locate Parts (left side of screen)
4. Click on State desired

To source service support locally follow instructions below for nearest authorized service agent:

1. Log onto www.traulsen.com
2. Select Service Directory (top of screen)
4. Click on State desired

Note: When calling for spare parts or service support, please make sure you have model and serial number of unit available.

X. c - WARRANTY REGISTRATION:

The warranties for your new Traulsen unit may be registered with us by contacting our Ft. Worth facility by phone at 800-825-8220 or you may register on line:

1. Log onto www.traulsen.com
2. Select Service Directory (top of screen)
3. Select Warranty Registration Form (left side of screen)
4. Fill out information requested
5. Select Submit to complete unit warranty registration

XI. WARRANTIES

STANDARD DOMESTIC WARRANTY

TRAUlsen & CO., INC. warrants new equipment to the original purchaser, when installed within the United States against defective material and workmanship for one (1) year from the date of original installation. Under this warranty, TRAUlsen & CO., INC. will repair or replace, at its option, including service and labor, all parts found to be defective and subject to this warranty. The compressor part is warranted for an additional four (4) years. During this period TRAUlsen & CO., INC. will supply replacement compressor (s) if deemed defective, however, all installation, recharging and repair costs will remain the responsibility of the owner. The drawer (s) are warranted for and an additional two (2) years. During this Period TRAUlsen will supply replacement parts only if deemed defective (excluding gaskets), however, all installation and repair costs will remain the responsibility of the owner.

This warranty does not apply to damage resulting from fire, water, burglary, accident, abuse, misuse, transit, acts of God, terrorism, attempted repairs, improper installation by unauthorized persons, and will not apply to food loss.

For Traulsen units purchased with a remote feature, standard warranty will apply only to those components contained within the unit to the point of connection of the refrigeration lines leading to the remote compressor.

THERE ARE NO ORAL, STATUTORY OR IMPLIED WARRANTIES APPLICABLE TO TRAUlsen, INCLUDING BUT NOT LIMITED TO, ANY IMPLIED WARRANTY OF MERCHANTABILITY OR FITNESS FOR ANY PARTICULAR PURPOSE WHICH EXTEND BEYOND THE DESCRIPTION ON THE FACE HEREOF. TRAUlsen SHALL HAVE NO OBLIGATION OR LIABILITY FOR CONSEQUENTIAL OR SPECIAL DAMAGES, GROWING OUT OF OR WITH RESPECT TO THE EQUIPMENT OR ITS SALE, OPERATION OR USE, AND TRAUlsen NEITHER ASSUMES NOR AUTHORIZES ANYONE ELSE TO ASSUME FOR IT ANY OBLIGATION OR LIABILITY IN CONNECTION WITH THE EQUIPMENT OR ITS SALE, OPERATION OR USE OTHER THAN AS STATED HEREIN.

MICROPROCESSOR CONTROL WARRANTY

TRAUlsen, warrants to the original purchaser of the microprocessor control when installed as part of the Refrigeration/Hot Food Equipment manufactured and sold by TRAUlsen, to be free of defects in material and workmanship under normal service and use for a period of two (2) years from the date of installation. Under this warranty statement, TRAUlsen will repair or exchange at TRAUlsen'S discretion, F.O.B. factory, any part of said control, which proves to be defective. Inspection by the TRAUlsen Service Department of parts claimed defective shall be final in determining warranty status. The warranty is to include repair or exchange of any defective In-Warranty control or part (s) of said control for:

Part (s) –Any TRAUlsen microprocessor control supplied part (s) found to be defective.

Labor –The labor charges from a Traulsen Certified Service Agent to effect the repair or exchange of the defective part(s).

“Defective Part Return” – All claimed defective part(s) must be returned to TRAUlsen for defect validation within 30 days from the date of the repair. Failure to return all claimed defective part(s) to TRAUlsen will invalidate the warranty claim, this warranty statement, and forfeit payment for those repairs effected.

This warranty does not apply to damage resulting from fire, water, burglary, accident, abuse, misuse, transit, acts of God, terrorism, attempted repairs, improper installation by unauthorized persons, and will not apply to food loss, and will not apply if said equipment is located outside The United States.

INTERNATIONAL COMMERCIAL WARRANTY

(for Canadian warranties see domestic US warranty)

TRAUlsen & CO., INC. warrants to the original purchaser the Refrigeration Equipment manufactured and sold by it to be free from defects in material and workmanship under normal use and service for a period of one (1) year from date of shipment. Under this warranty, TRAUlsen & CO., INC. will reimburse the purchaser for the replacement of any part of said equipment (excluding dryers & refrigerant gas) which then proves to be defective. This warranty does not apply to damage resulting from fire, water, burglary, accident, abuse, misuse, transit, acts of God, terrorism, attempted repairs, improper installation by unauthorized persons, and will not apply to food loss.

TRAUlsen'S standard warranty does not apply to Export Sales. Rather, for a period of one (1) year from date of original installation not to exceed Fifteen (15) months from date of shipment from factory, TRAUlsen:

will replace, F.O.B. factory, any defective parts normally subject to warranty.

will not cover the cost of packing, freight or labor such costs being the sole responsibility of the dealer/end user.

THIS WARRANTY IS IN LIEU OF ALL OTHER WARRANTIES EITHER EXPRESSED OR IMPLIED AND CONSTITUTES TRAUlsen'S FULL OBLIGATION AND LIABILITY. WARRANTIES NOT AVAILABLE ON REMOTE MODELS.

XII. SERVICE PARTS LIST

NOTE: Part numbers listed are for standard products as currently manufactured.

For products manufactured as other than standard, please contact the factory. Drawers: Models with a * next to model number are designed with two pan configurations. Determine which is needed based on configuration of drawer.

ITEM	DESCRIPTION	PART NUMBER
CASTER	ALL MODELS	
	4" ADJUSTABLE CASTER NO LOCK	SER-60536-00
	4" ADJUSTABLE CASTER WITH LOCK	SER-60536-01
	3 1/8" ADJUSTABLE CASTER NO LOCK	348-10013-00
	3 1/8" ADJUSTABLE CASTER WITH LOCK	348-10013-01
DRAWER	1 PAN SIDE-BY-SIDE MODELS TE035HT & TE065HT*	
	DRAWER ASSEMBLY	550-10053-00
	DRAWER FACE ASSEMBLY	550-10057-00
	DRAWER FRAME ASSEMBLY	550-10059-00
	DRAWER FRAME INSERT	SER-60537-00
	DRAWER GASKET	341-60176-02
	DRAWER ROLLER	344-60155-00
DRAWER	2 PAN SIDE-BY-SIDE MODELS TE048HT, TE065HT*, TE084HT, TE096HT, TE110HT, TE125HT* TE139HT	
	DRAWER ASSEMBLY	550-10054-00
	DRAWER FACE ASSEMBLY	550-10058-00
	DRAWER FRAME ASSEMBLY	550-10060-00
	DRAWER FRAME INSERT	SER-60537-01
	DRAWER GASKET	341-60176-03
	DRAWER ROLLER	344-60155-00
DRAWER	3 PAN SIDE-BY-SIDE MODELS TE060HT & TE125HT*	
	DRAWER ASSEMBLY	550-10067-00
	DRAWER FACE ASSEMBLY	550-10076-00
	DRAWER FRAME ASSEMBLY	550-10077-00
	DRAWER FRAME INSERT	SER-60537-03
	DRAWER GASKET	341-60176-04
	DRAWER ROLLER	344-60155-00
DRAWER	2 PAN FRONT-TO-BACK MODEL TE072HT	
	DRAWER ASSEMBLY	550-10074-00
	DRAWER FACE ASSEMBLY	550-10069-00
	DRAWER FRAME ASSEMBLY	550-10070-00
	DRAWER FRAME INSERT	SER-60537-02
	DRAWER GASKET	341-60176-01
LOUVER	ALL MODELS	
	LOUVER PANEL LEFT HAND SYSTEM	500-70075-00
	LOUVER PANEL RIGHT HAND SYSTEM	500-70075-01
MICROPROCESSOR	ALL MODELS	
	MICROPROCESSOR CONTROL HEAD	337-60403-00
	MICROPROCESSOR CABINET TEMPERATURE SENSOR	337-60405-03
	MICROPROCESSOR COIL TEMPERATURE SENSOR	337-60406-03
	MICROPROCESSOR LIQUID LINE TEMPERATURE SENSOR	337-60407-01
	MICROPROCESSOR RELAY MODULE	337-60317-00

NOTES:

HOURS OF OPERATION:

Monday thru Friday 7:30 am - 4:30 pm CST



Quality Refrigeration

Traulsen

4401 Blue Moud Road Fort Worth, TX 76106

Phone (800) 825-8220 Fax (817) 740-6757

Website: www.traulsen.com