



PFC SERIES COUNTERTOP FRYERS INSTALLATION - INSPECTION - MAINTENANCE



Be sure ALL operators read, understand and have access to this manual at all times.

PERFECT FRY

www.perfectfry.com

42 Allen Martin Drive, Essex Junction, Vermont 05452 USA Telephone: (802) 658-6600 Fax: (802) 864-0183

PN 83539 Rev B (10/20)

© 2020 - Perfect Fry Company

TABLE OF CONTENTS

Owner's Responsibilities	4
Regulations & Recycling.....	5
Safety First	6
INSTALLATION	
Electrical Power Supply (North American Models).....	7
Prepare Countertop Area.....	8
Unpack	8
ASSEMBLY	10
COOKING	14
CLEANING	
Daily Maintenance	15
Weekly Maintenance	15
Periodic Maintenance	17
TIPS ON DEEP FRYING	18
OIL FACTS	19
OPERATING INSTRUCTIONS	22
Manual Mode.....	23
Open Door - Paused Cook Cycle	25
Shutting Down	26
USER DEFINED OPTIONS	27
CTS™ (Cook Time Sensitivity).....	28
Option Changes.....	33
Customizing Presets.....	34
Customizing Presets on the Front Label	35
HELP	
System Error Conditions.....	36
Troubleshooting Table	39
PFS AUTOMATIC EXTINGUISHER	40
DECLARATION OF CONFORMITY	42
ORIGINAL STANDARD EQUIPMENT LIMITED WARRANTY	43
US & Canada.....	43
International Units.....	45

THANK YOU FOR PURCHASING A PFC FROM PERFECT FRY!

WARRANTY REGISTRATION

Be sure ALL operators read, understand and have access to this manual at all times.

1. Simply fill out the online warranty registration form anytime at www.perfectfry.com and automatically receive your warranty activation code.

FRYER ACTIVATION

SEE THIS LCD

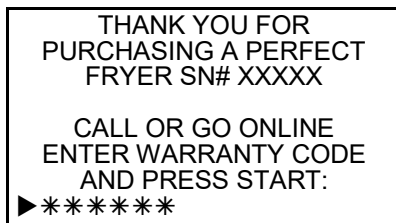

DO THIS

1. Enter your warranty activation code.
2. Press START.
3. Your PFC is now permanently activated.

GET THIS LCD

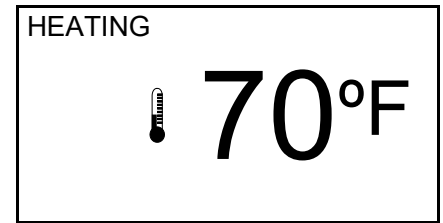

**For temporary access, enter 123456 then press START.
Temporary access is valid for 90 entries.**

Now that you have registered and activated your fryer;

- Take comfort in knowing that the management and staff at Perfect Fry Company are dedicated to ensure that you, the owner and operator of a Perfect Fry unit, receive a top quality product that is thoroughly inspected and tested prior to shipment.
- Take comfort in knowing that our local Authorized Service and Parts Distribution (ASAPD) network is committed to supplying your service and warranty needs. Each ASAPD has dedicated service staff that is able to answer any questions you may have regarding the operation of your Perfect Fry unit. We also have an online knowledgebase available 24/7/365 at perfectfry.com with many great tips and solutions.

OWNER'S RESPONSIBILITIES



IT IS THE OWNER'S RESPONSIBILITY TO:

- Ensure the Perfect Fry unit is properly maintained.
- Allow only properly trained personnel to operate, clean and maintain a Perfect Fry unit.
- Contact local authorities having jurisdiction to insure that the installation conforms to all local fire, building and health regulations.
- Schedule and maintain documentation that the appropriate inspection and maintenance of the PFS Automatic Extinguisher has been completed.
- Ensure that the model ready for installation matches the supply voltage.
- Ensure that the main power supply is disconnected before the Perfect Fry unit is serviced.
- Ensure that all safety devices are intact.
- Ensure that a proper surface is provided for the Perfect Fry unit to sit on.
- Ensure that proper clearances are kept.
- Operate and store the Perfect Fry unit above 32°F (0°C).
- Return the Perfect Fry unit for recycling when it reaches end of life.

REGULATIONS & RECYCLING

Installation of your Perfect Fry unit must conform to all local fire and health regulations and building codes. The installation use and maintenance is to be in accordance with the Standard for Ventilation Control and Fire Protection of Commercial Cooking Operations, NFPA 96 - 2004.

The table below describes the standards that your Perfect Fry unit has been tested to and the corresponding listing marks depending on your region.

STANDARD	DESCRIPTION	LISTING MARK
UL 197 UL 197 SB (UL 710B)	Commercial electric cooking appliances. Commercial electric cooking appliances with recirculating systems. UL 197 & UL 197 SB supplement also reference the following standards which your Perfect Fry unit meets applicable parts thereof:	
	<ul style="list-style-type: none"> • UL 1046: Grease Filters for Exhaust Ducts. • UL 300: Fire Testing of Fire Extinguishing Systems for Protection of Restaurant Cooking Areas. • NFPA 17A: Wet Chemical Extinguishing Systems. • NFPA 96: Standard for Ventilation Control and Fire Protection of Commercial Cooking Operations. • EPA 202: Determination of Condensable Particulate Emissions for Stationary Sources. 	
CSA 22.2 No. 109-M1981	Commercial Cooking Appliances forming part of Canadian Electrical Code, Part 2 Safety Standards for Electrical Equipment.	
NSF 4	Commercial Cooking, Rethermalization, and Powered Hot Food Holding and Transport Equipment.	
EN60335-1	Safety of Household and Similar Electrical Appliances Part 1. General Requirements Amendment 8913 - October 1995 Amendment 9475 - May 1997	
EN60335-2-37	Safety of Household and Similar Electrical Appliances Part 2. Commercial Electric Deep Fat Fryers	
EN61000-6-1 EN61000-6-3	Electromagnetic Compatibility (EMC) – Emissions & Immunity for Light Industrial Environments	

The table below describes the recycling procedures for your PERFECT FRY PFC.

WEEE (Waste Electrical & Electronic Equipment) 2002/96/EC	When your PFC has reached end of life, please deliver the fryer to your local distributor. They will prepare and deliver the fryer for recycling to the WEEE collection system in your country. Most of the fryer's materials can be recycled. DO NOT DISPOSE OF THE FRYER IN MUNICIPAL WASTE!	
---	---	---

SAFETY FIRST



LIFTING & MOVING:

- Your fryer's gross shipping weight is 92 lb. (42 kg). Net weight = 80 lb. (36 kg). **DO NOT LIFT THE FRYER BY YOURSELF. ALWAYS REMOVE OIL BEFORE MOVING FRYER.**

DEEP FRYING:

- Cooking oil is very hot ~350°F (177°C). Hot oil can cause severe burns. **DO NOT TOUCH THE COOKING OIL UNLESS YOU ARE SURE IT HAS COOLED.**

HEATER MODULE:

- DO NOT DROP
- DO NOT IMMERSE IN WATER

CLEANING:

- Before cleaning fryer or removing oil, let fryer cool to 122°F (50°C). **DO NOT TOUCH HEATER MODULE, VAT OR OIL UNLESS YOU ARE SURE IT HAS COOLED.**

COOKING OIL MAINTENANCE:

- For sanitation and safety, we recommend that the cooking oil is replaced once a week, more often for higher volume usage. Use a commercial grade deep-fryer formulated cooking oil. See Oil Facts on page page 19.

SERVICING:

- **DISCONNECT THE POWER SOURCE BEFORE SERVICING THE FRYER.** There is no need to unplug your Perfect Fry unit for normal cleaning or maintenance.

STORAGE:

- Do not store your fryer below 32°F (0°C)
- Intended for indoor use only

INSTALLATION

ELECTRICAL POWER SUPPLY (NORTH AMERICAN MODELS)

- Your PERFECT FRY PFC must be connected to a dedicated electrical circuit that meets your fryer's requirements (see table below).

 **CAUTION**

Improper installation may damage the fryer and void your warranty.

- All electrical connections to comply with local and national standards and codes.
- If your fryer's plug does not fit your wall outlet receptacle, have an electrician install the appropriate NEMA receptacle within 4 feet of the fryer.
- See the manufacturer's label on your fryer for the electrical Model No. PFCXXX, then check off your Model Number.

PFC Model	Voltage	Amps	Circuit Amps	Watts	Power Supply
<input type="checkbox"/> PFC 570	240	24	25	5700	For Use on an individual branch circuit rated 25A minimum. For supply connectors, use minimum no. 10 AWG wire (30A rated). This Fryer must be properly Connected to a grounded dedicated 240 VAC single phase circuit according to local installation standards and codes
<input type="checkbox"/> PFC 570	208	27	30	5700	For Use on an individual branch circuit rated 30A minimum. For supply connectors, use minimum no. 8 AWG wire (40A rated). This Fryer must be properly Connected to a grounded dedicated 208 VAC single phase circuit according to local installation standards and codes
<input type="checkbox"/> PFC 375	240	16	20	3750	For Use on an individual branch circuit rated 20A minimum. For supply connectors, use minimum no. 12 AWG wire (25A rated). This Fryer must be properly Connected to a grounded dedicated 240 VAC single phase circuit according to local installation standards and codes
<input type="checkbox"/> PFC 300	240	12.5	20	3000	For Use on an individual branch circuit rated 20A minimum. For supply connectors, use minimum no. 12 AWG wire (20A rated). This Fryer must be properly Connected to a grounded dedicated 240 VAC single phase circuit according to local installation standards and codes
<input type="checkbox"/> PFC 187	120	16	20	1875	For Use on an individual branch circuit rated 20A minimum. For supply connectors, use minimum no. 12 AWG wire (12A rated). This Fryer must be properly Connected to a grounded dedicated 120 VAC single phase circuit according to local installation standards and codes
<input type="checkbox"/> PFC 570*	400/230/3Ø Wye (4 wire)	9	15	5700	This Fryer must be properly connected to a grounded dedicated 400 VAC three phase circuit according to local installation standards and codes

International only, not available in US or Canada.

PREPARE COUNTERTOP AREA

Clear space for your PFC fryer on the counter. Refer to the following figure for product and clearance requirement dimensions.

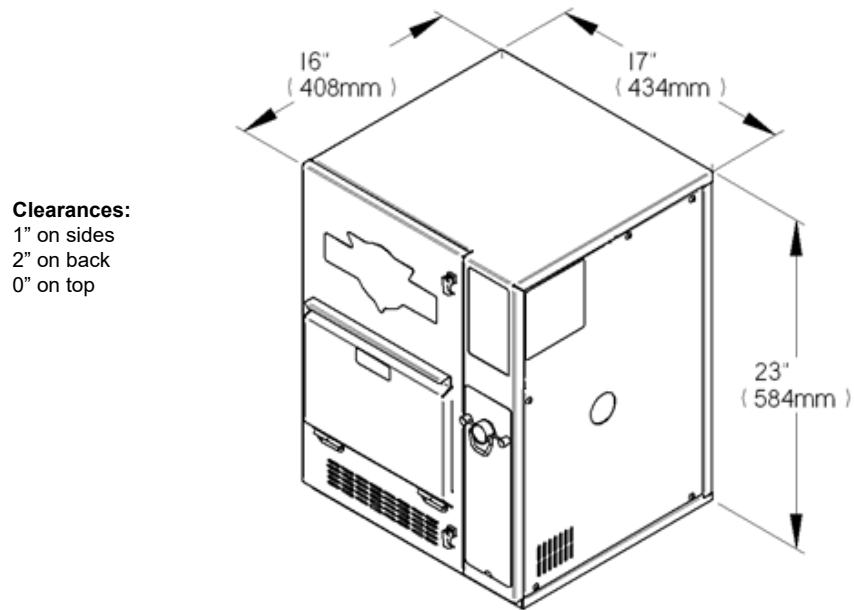

UNPACK

1. Cut straps on shipping box.
2. Remove box top and body
3. Remove outer plastic wrapping and keep box along with foam corners and sides
4. Remove all foam stuffing and parts

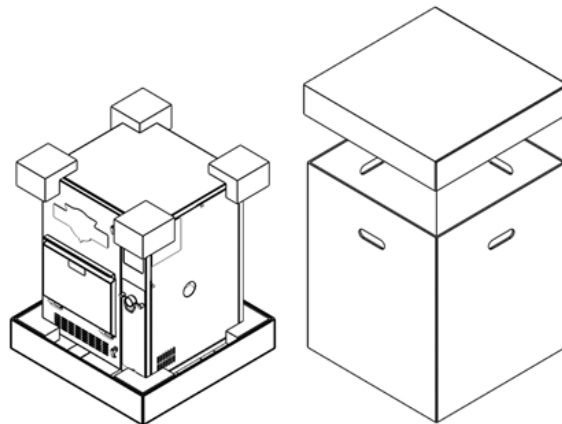

5. Put check mark in the box once the part is removed

CAUTION

Your PERFECT FRY weighs 80 lbs (36 kg). Lift it carefully with your legs or with the help of another person and place it in its final location.

6. Ensure that blow-off caps on fire extinguisher nozzles are kept in place
7. Proceed to ASSEMBLY section.

1 Air Filter Cage

2 Air Filter Cartridge

3 Grease Filter

4 Grease Filter Tray

5 Basket Lift

6 Heater Module

7 Oil Vat

8 Oil Spill Tray

9 Front Panel

10 Door

11 Door Spring (2)

12 Extra Large Basket

13 Oil Drainage Kit (Optional)

14 Extra Large Basket Cover (Optional)

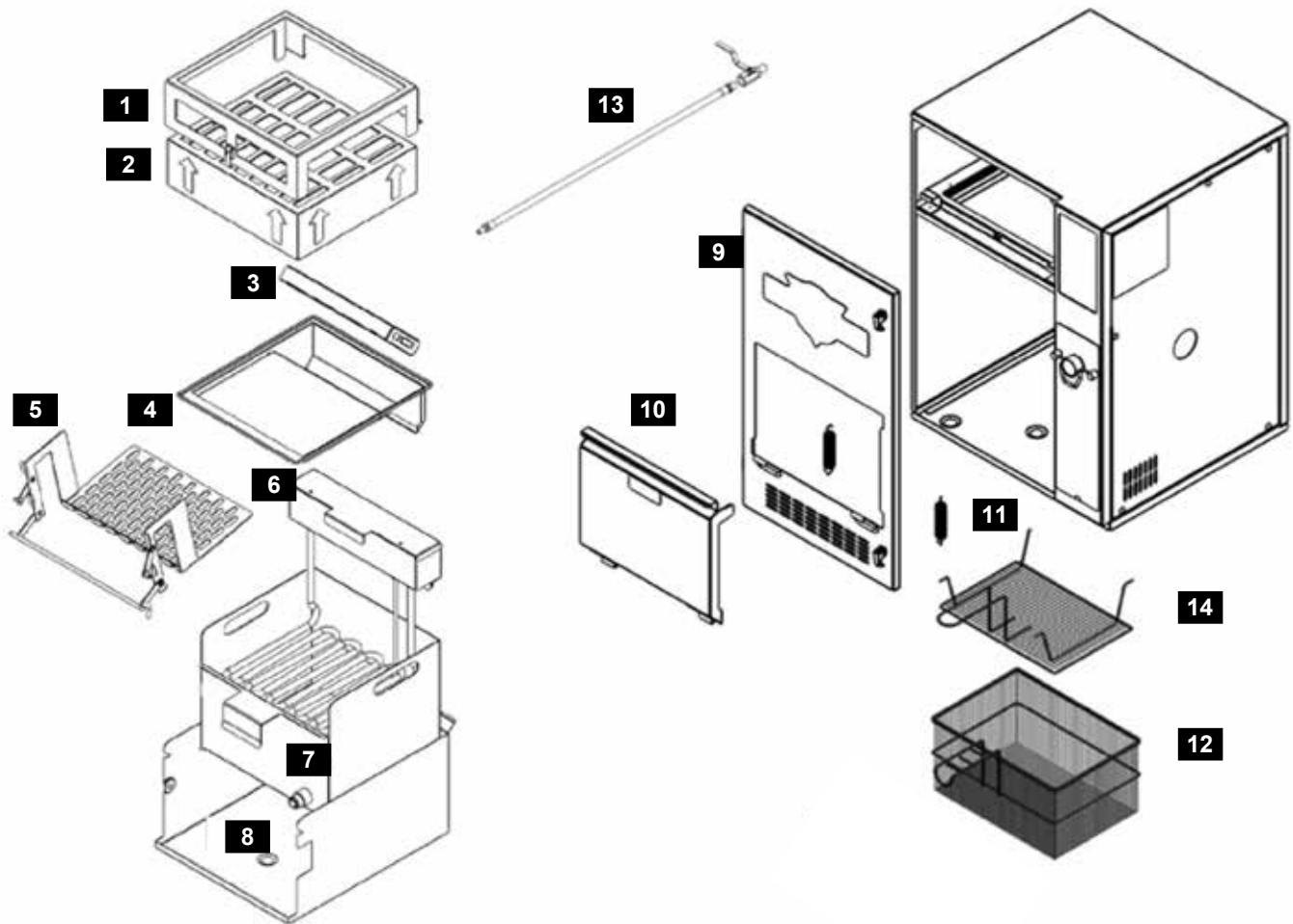

ASSEMBLY

1. Clean parts and inside of cabinet (all except air filter cartridge)
 - a. Wash in warm soapy water
 - b. Rinse with hot water
 - c. Rinse with vinegar solution (1 part vinegar to 2 parts water)

CAUTION

The heater box and heat lamp must NOT be immersed in water or other liquid.

2. Plug in fryer and press **ON/OFF**
NOTE: LCD will display what is missing and will beep twice when part is installed
3. Install grease filter into grease filter tray
Note: magnet should be on right side
4. Install grease filter/grease filter tray into filter compartment by sliding along rails and towards back.
5. Fit air filter cage over air filter cartridge.
Note: Make sure arrows are pointing up.

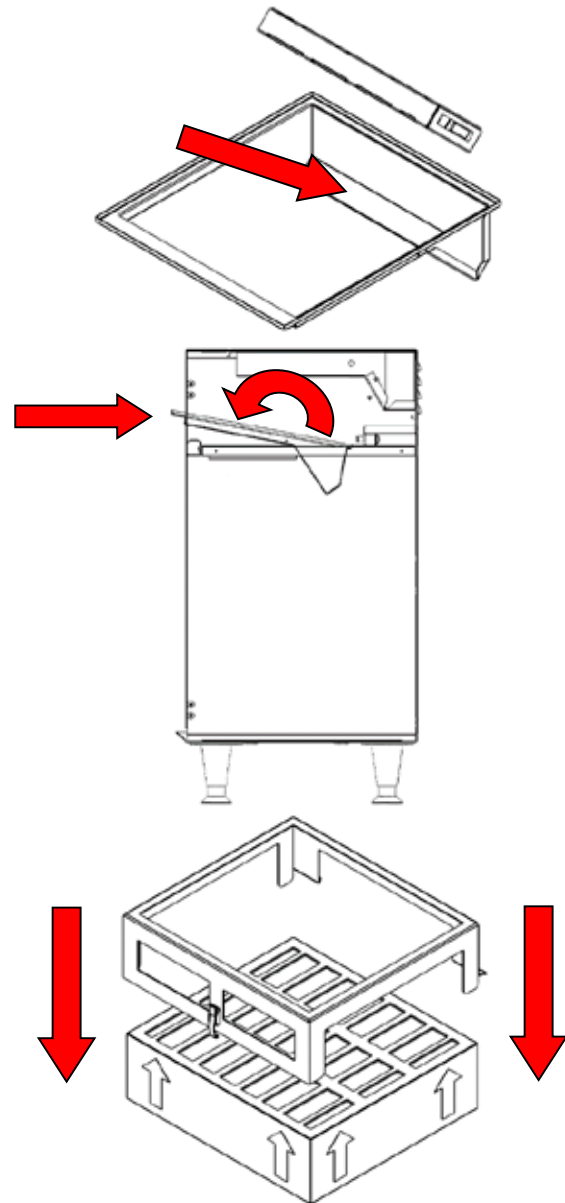
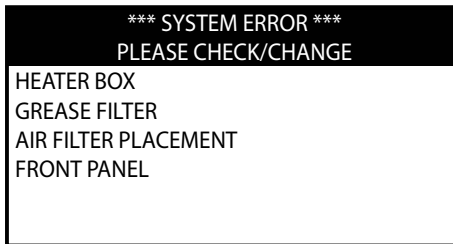

6. Slide air filter cartridge firmly back into filter compartment and fasten down with latch.

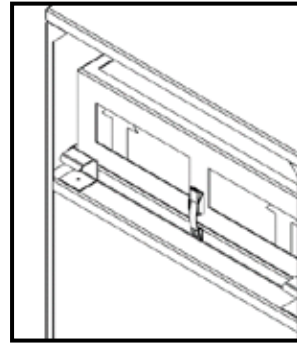

7. Install spill tray into bottom cooking compartment.

NOTE: Indents on bottom of spill tray should fit into indents on bottom of cabinet.

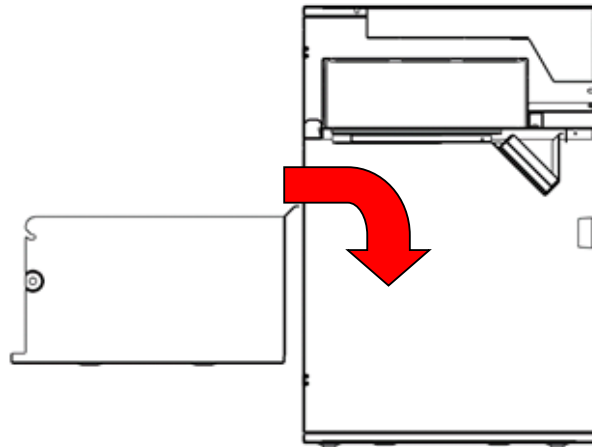

8. Set heater module onto vat.

Note: “^” grooves on bottom of heater module should fit onto back of vat

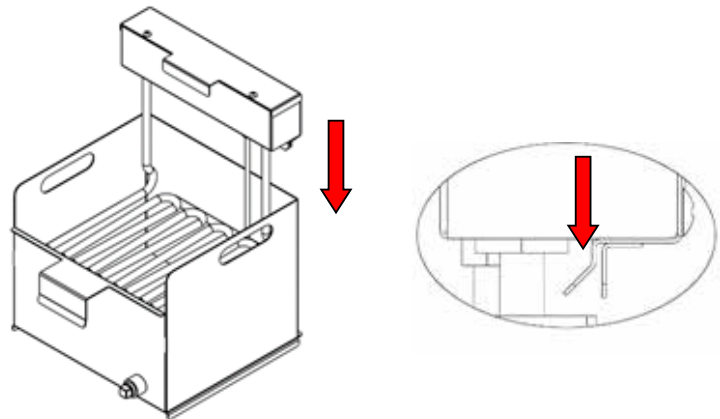

9. Pour frying oil into vat. Fill to **COLD** level mark. Use commercial grade deep fryer cooking oil. **DO NOT OVERFILL**

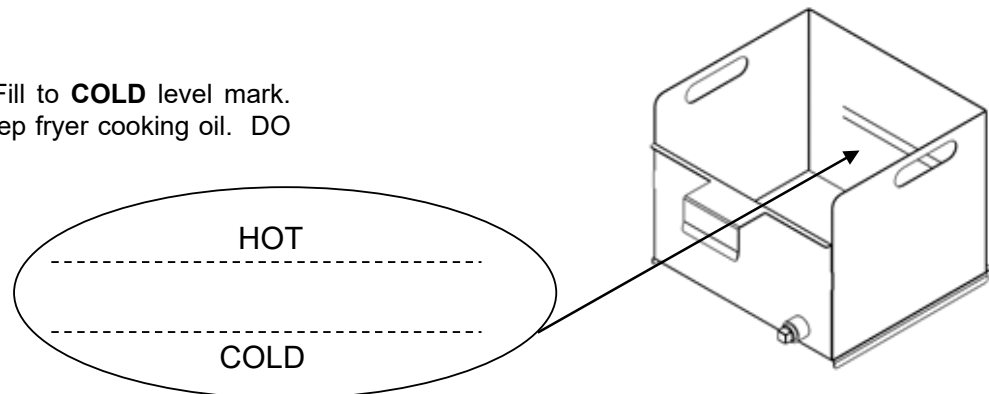

10. Slide heater module/vat into cooking compartment and push in all the way. Ensure electrical connection is complete with a firm push on the heater module.

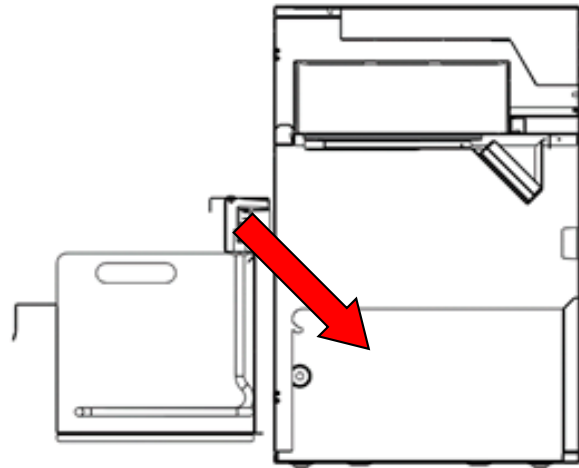

11. Install drip tray in-front of oil vat. Drip tray will fit snug between front edge of oil vat and inside edge of spill tray

NOTE: If drip tray does not fit, press heater module in further to complete connection.

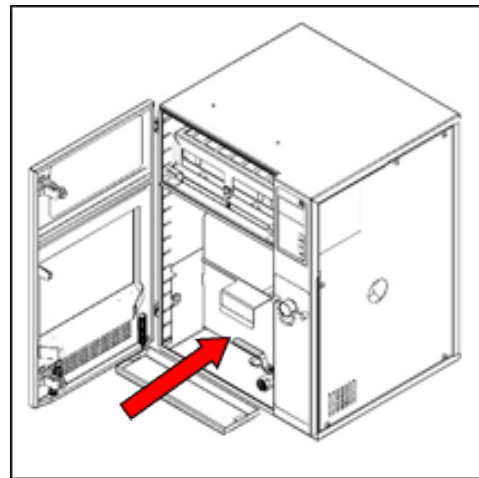

12. Install basket lift.

- a. Hold basket tray vertical
- b. Install rod into pivot hole – left side

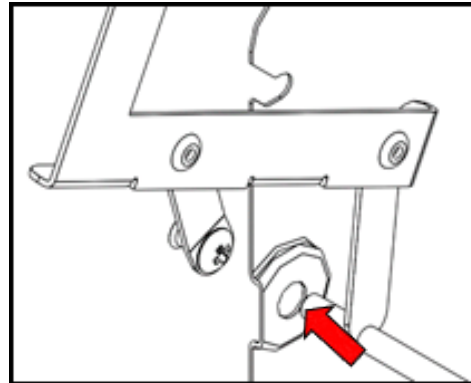

- c. Install rod into motor coupler – right side

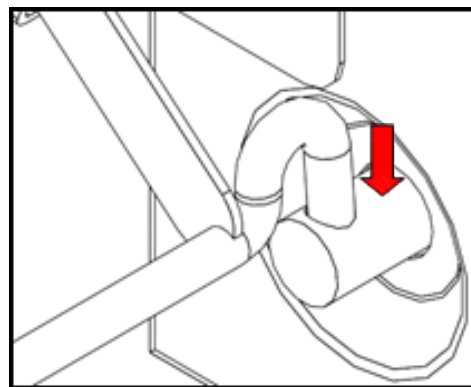

- d. Pivot basket tray forward from vertical position and insert arms into spill tray

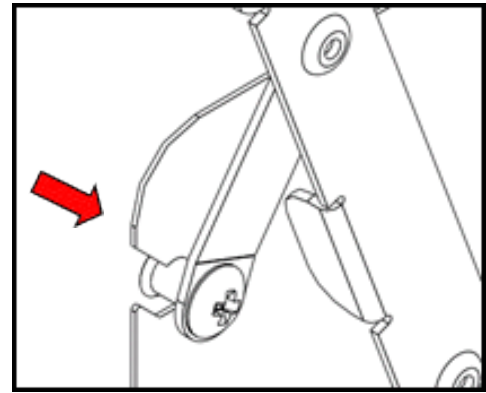

13. Install and close front panel. Turn latch $\frac{1}{4}$ turn clockwise and press down.

14. The fryer will now begin heating. In a few minutes, you will be ready to start cooking!

COOKING

Extra Large Basket

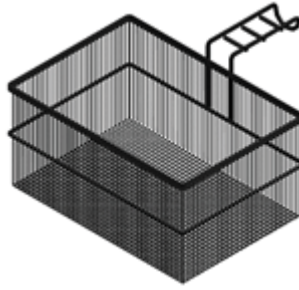

Fill Line

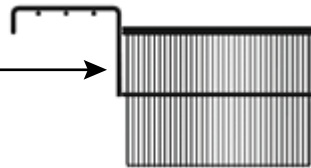

1. Insert Basket



2. Press start



3. Frying



4. Remove & Serve



CLEANING

DAILY MAINTENANCE

CAUTION

Do not unplug the fryer and always make sure the fryer is turned off.

CAUTION

Do not touch heater module, oil vat or oil unless you are sure it has cooled.

1. Wipe basket(s) with paper towel to remove crumbs and food particles.
2. Wipe crumbs, oil and any other food matter from inside of drawer using a paper towel.
3. Clean outside of fryer with a good stainless steel cleaner and wipe dry.

CAUTION

Do not clean the outside or any other stainless steel part using abrasive cleaners.

4. Check oil level on the back of vat to make sure it is up to cold line (at room temperature). If not, add oil as necessary. Replace the cooking oil once a week or more often if necessary. Use a **COMMERCIAL GRADE DEEP FRY COOKING OIL**.

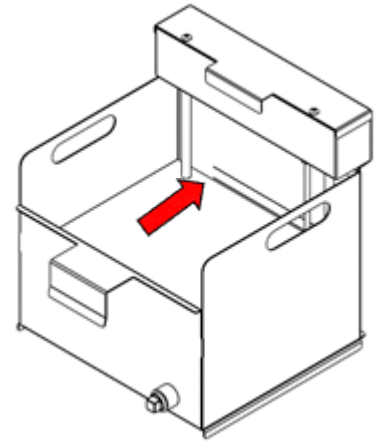

WEEKLY MAINTENANCE

CAUTION

Do not unplug the fryer and always make sure the fryer is turned off.

CAUTION

Do not touch heater module, oil vat or oil unless you are sure it has cooled.

1. Open front panel by lifting and turning latches. Lift it off its hinges. The front panel can be cleaned as is or apart if preferred.
2. Remove air filter cartridge and set aside (for replacement, see page 20).

CAUTION

Do not wash air filter cartridge.

3. Remove grease filter tray from cabinet. Remove grease filter from tray and drain any oil that has accumulated. Wash both parts in soap and hot water. Rinse well in hot water and dry.

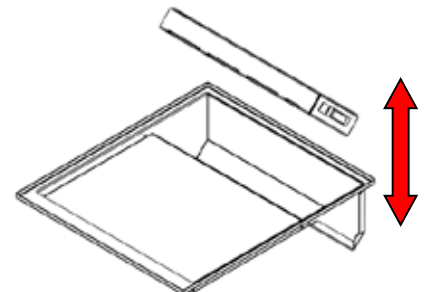
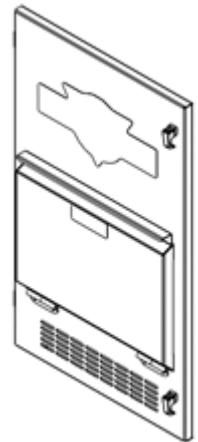

4. Pour cooking oil from vat into containers for disposal. Have empty containers handy for proper disposal of used cooking oil. A rendering company can help with proper disposal.
5. Remove basket lift, oil vat and heater module (picture right). Spray parts with oven cleaner, enclose with plastic bag for at least one hour or leave overnight if possible. Wash in soap and hot water and rinse well in hot water. Rinse parts in a solution of: 1 part white vinegar [5% acetic acid] and 2 parts water. **The vinegar rinse is very important.** It neutralizes soap residue that causes oil breakdown foaming. Soap residue turns oil dark and reduces its performance significantly. Clear water rinse parts. **Clean the male and female terminals on connectors with rubbing alcohol and cotton swab.**

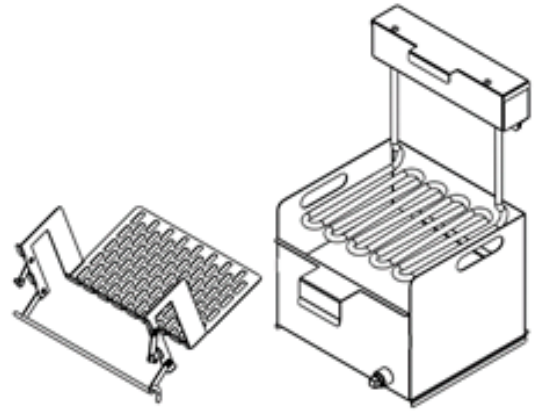

CAUTION

The heater box must **NOT** be immersed in water or other liquid.

CAUTION

Do not spray male connector.

6. Remove spill tray and drain any oil that has accumulated. Wash in soap and hot water. Rinse well in hot water and dry.
7. After removing heater module, push plug cover over female plug before cleaning. After cleaning replace in holder.
8. With internal components removed, clean cooking and filter compartments with grease cutting soap or oven cleaner if necessary. Rinse with damp cloth and dry.

CAUTION

Do not spray female connector.

9. Clean countertop and external surfaces.
10. Ensure that blow-off caps on fire extinguisher nozzles are kept in place.
11. Re-install all parts.P

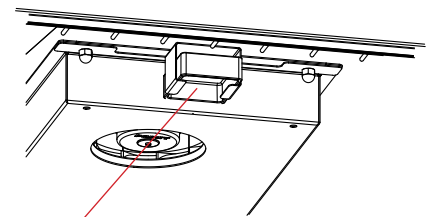
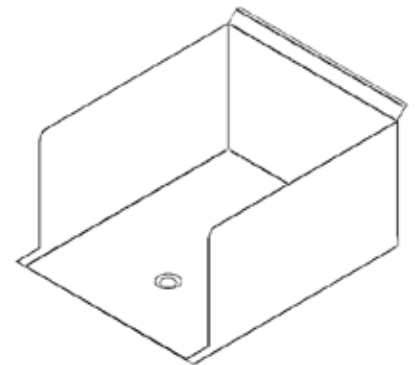

Plug holder

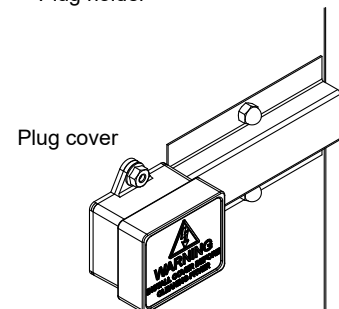

Plug cover

PERIODIC MAINTENANCE

Air Filter Cartridge Replacement

- Replace the air filter cartridge at least once every 3 months, more often for higher volume usage. Replacement is safer and easier when the fryer is cool rather than hot.
- Only PERFECT FRY filters may be used in your Perfect Fry unit.

Steps to replace air filter cartridge

1. Open front panel by lifting and turning latches
2. Release latch on air filter cage, and remove air filter cage and air filter cartridge from filter compartment
3. Remove old used air filter cartridge from air filter cage.
4. Wipe air filter cage clean.
5. Fit air filter cage over new air filter cartridge and write date on cartridge. (↑↑ Arrows up)
6. Install air filter cage and new air filter cartridge firmly back into filter compartment and latch in place.
7. Close front panel and latch shut.

PFS Automatic Extinguisher

- The PFS automatic extinguisher must be inspected monthly by the owner/operator and semi-annually by authorized service personnel as per NFPA 17A. It is important that a maintenance program is set up with a local fire service company to ensure that local jurisdictional codes are being met. Please refer to PFS Automatic Extinguisher section for more information.

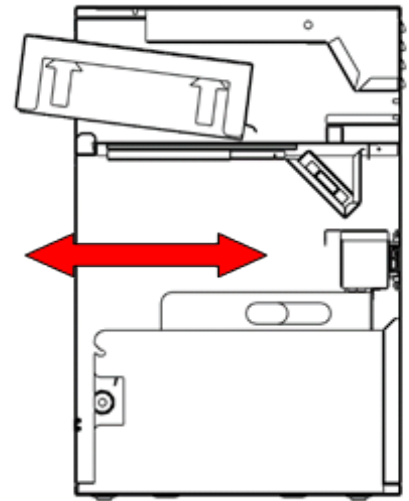
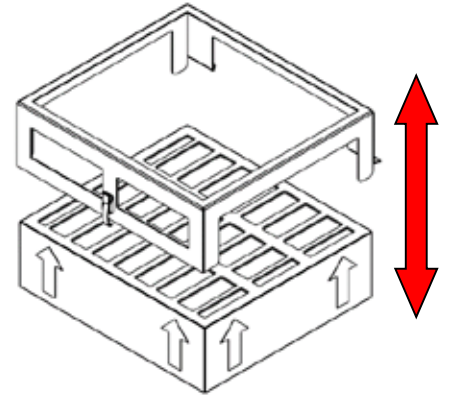

TIPS ON DEEP FRYING

GREAT FOOD IN LESS TIME

- **Use premium quality commercial deep frying oil.** Canola and Soybean oils are recommended. Do not use household cooking oils from your local supermarket. Poor quality oils may shorten the life of the air filter cartridge.
- **Keep food frozen until ready to fry.** Frozen product will absorb less oil during the cooking process.
- **Remove ice from food.** Ice results in excess bubbling and spillage of oil out of the vat.
- **Minimize the moisture.** Excess moisture extends the cooking time. Water, ice, sugar and breading all contribute to shortening the life of the oil

MINIMIZE THE MOISTURE

REDUCE THE COOKING TIME

MAXIMIZE THE PROFIT

- **Try to reduce the amount of breading that falls off of the food.** Breading often has sugar and other ingredients that will reduce the oil's life and darken the appearance of food. Consider filtering the oil to remove the breading particles.
- **Do not overfill the basket.** Excess food may not be cooked properly

COMMON QUESTIONS

• **How Much Oil to Use?**

The PERFECT FRY has a capacity of 2 gallons(8L) of oil. Fill the oil vat to the cold line only.

• **How Much to Fry?**

Fill the drawer to the top only. The drawer has an approximate capacity of 2 lbs (1 kg) of product per cycle.

• **What is the Ideal Temperature Range for Cooking?**

The ideal temperature range for cooking product is between 350°F and 360°F (177°C and 182°C). The factory default setting for cooking temperature is 350°F (177°C).

• **Should Frozen Food Be Defrosted?**

DO NOT THAW FROZEN FOOD! Frozen foods only should be put directly into the fryer in order to minimize moisture.

• **Can I Refreeze Frozen Foods?**

NO, do not refreeze frozen foods. Foods that are refrozen can absorb more oil, which will result in a dry, brittle and tasteless product.

OIL FACTS

Frying oil is especially formulated to withstand high temperatures. For this reason, you must ensure you are using the right product. Liquid vegetable shortening is produced by several companies; the oil has an additive and/or has been formulated to increase the performance during high temperature usage.

DO NOT USE OIL THAT IS RECOMMENDED BOTH FOR SALAD AND FRYING!

Fill the oil vat to the cold line only. The oil expands as it heats and if overfilled, the bottom of the basket will remain in the oil when in the up/serve position.

How Much to Fry?

- Fill the basket no higher than the top. Do not overfill the basket.
- Keep basket clean and free of breading/batter build up.
- Remove ice crystals or excess water before frying.
- Do not salt or season before frying.
- Remove surplus and/or batter before frying.
- Do not allow frozen food to thaw before frying.
- Drain fried foods before serving.

How Hot is TOO Hot?

Ideal frying temperature range is between 350°F and 360°F (177°C and 182°C). Factory default setting is 350°F (177°C). When frying at too low a temperature, food absorbs more oil which increases oil consumption.

Excessive Oil Usage?

The fried product is absorbing oil. Possible reasons for this include:

- Excess breading or batter, shake off excess before frying.
- Allow basket to drain longer, adjust the drain time.
- Food is being allowed to thaw before frying.

Cleaning Your Fryer?

- Refer to the Cleaning section of this owner's manual. Remember to clean the basket and drawer daily.

Filtering Your Oil?

The most important procedure you can do is to maintain the oil, extending its life:

- Filter at least once a day, preferably first thing in the morning when the oil is at room temperature.
- Filtering removes all the contaminants from the previous days cooking.
- Clean the oil vat.

Points to Remember:

- Clean the cooking chamber at least once a week and rinse thoroughly.
- Filter oil daily.
- Do not overheat oil.
- Use the standby mode when possible.
- Do not salt product prior to frying.
- Remove ice crystals and moisture before frying.
- Maintain oil level in vat, check to ensure it is at the hot line often.
- The oil is dead when foaming appears continuously on the oil surface

Your oil, product taste, and customers depend on you.

If the oil temperature is set too high, the food will cook on the exterior and the interior will be undercooked. When the interior is cooked completely, the exterior will be overdone or burnt. The higher temperature will also cause the oil to break down faster and smoke.

During slow periods, take advantage of the standby mode which allows the oil to cool down to 275°F (135°C), prolonging the oil life and reducing energy costs while allowing quick recover time when required.

The oil temperature should not be adjusted when cooking different products. Adjust the cooking time instead.

Frozen Foods

Put frozen foods directly into the fryer. **DO NOT THAW FROZEN FOODS!** Blot excess water from food before frying. Remove ice crystals that may be at the bottom of the product bag.

OIL AND WATER DO NOT MIX! Water reacts with oil and makes it break down rapidly resulting in darkening, smoking and foaming (a process called hydrolysis). Excess water in the oil can cause the following problems:

- Unnecessary temperature drop meaning longer cooking times.
- More energy usage to maintain cooking temperature.
- Excessive splattering inside the fryer resulting in a mess to clean up.
- Decreased life of the air filter and the oil.

Refreezing Frozen Foods?

Frozen foods should be fried frozen. Foods that are refrozen can absorb more oil and make your fried foods taste greasy. Refrozen food forms excessive ice and these ice crystals can bond food pieces together causing clumping. Remember:

- Always FRY FOOD FROZEN.
- NEVER REFREEZE thawed food
- REMOVE ice crystals from product before frying.
- DO NOT accept thawed or refrozen product from supplier.

Excessive Foaming?

The main reason for foaming is improper rinsing of oil vat after cleaning:

- To remove soap residue, rinse 3 times with water after cleaning or neutralize with a water and vinegar solution (1 part white vinegar to 2 parts water).
- Take care of your oil; use standby mode during slow periods. High temperature and oxygen contribute to oil breakdown. Filter oil and clean vat at least once a day when using heavily breaded products.

Excessive Smoking/Oil Darkening?

- Oil is too hot, check temperature.
- Inadequate filtering, breading or batter build-up in vat causes oil breakdown, giving food a bitter taste.
- Moisture content is too high. Use precooked frozen products only. Remember to remove ice crystals.

Grease Soaked Food?

- Frozen food is being allowed to thaw before frying.
- Oil is in the advanced stages of breakdown, replace immediately.
- Oil temperature is too low, check temperature.
- Product has too much breading or batter, remove excess

Food Not Browning Properly?

- New oil may not brown the product; check color again after a few basket loads.
- Too much product is in the basket; fill no higher than the fill line.
- Product is not frying long enough, follow manufacturers suggested cooking times.
- Oil temperature is too low, check oil temperature.
- Product is frying in excess foam.
- Oil level is too low, check the oil level.

Premature Oil Breakdown?

- Oil is at full temperature during slow periods, use standby mode.
- Oil is contaminated. Never use wire brushes, copper pads or steel wool for cleaning. Use a hard bristle brush and filter oil regularly. Rinse with water vinegar solution.
- Also, see section; **HOW HOT IS TOO HOT?**

Statements used in OIL FACTS section are taken from:

- NAFEM Food Service Industry
- Canola Research Foundation
- Sysco Oil Publication

OPERATING INSTRUCTIONS

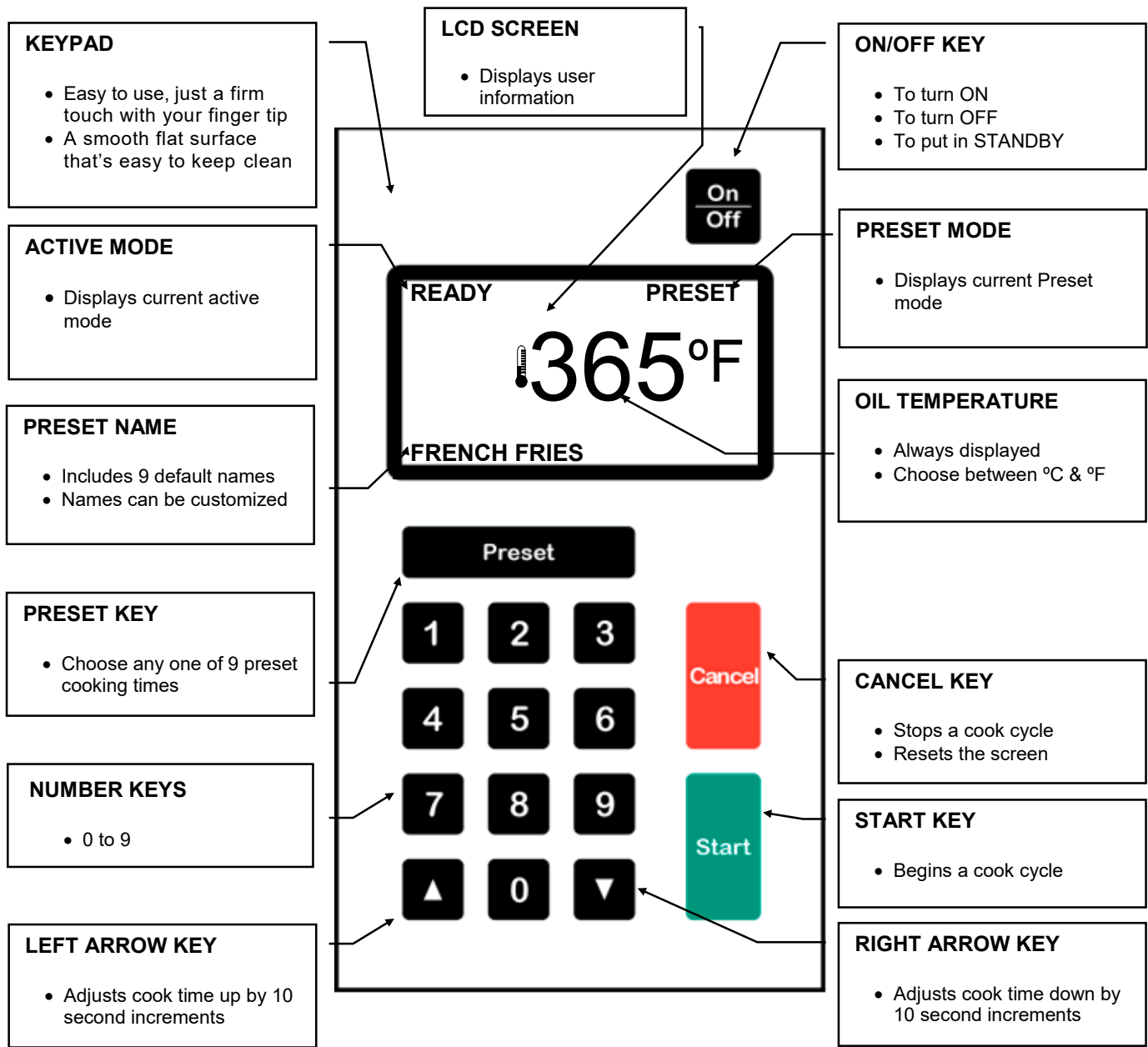
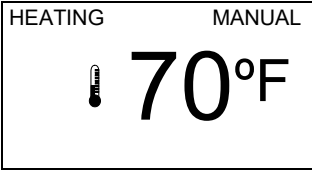



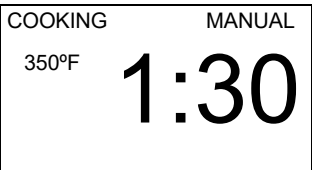

Table 1 Preset Mode Functionality

Feature	Manual Mode	Preset Mode	Preset Locked Mode
Manually enter cook time	X		
Automatically enters preset time		X	X
Remains in same mode after cook cycle			X

STARTING UP

OPERATOR ACTION	DISPLAY READS	PFC FRYER
1) Press ON/OFF for 1/2 second.		1) Now in HEATING mode 2) Oil temperature rising to operating temperature
2) Allow 10 to 30 minutes for oil to reach operating temperature (350°F or 177°C).		3) Once operating temperature is reached, now READY to start cooking.

MANUAL MODE

OPERATOR ACTION	DISPLAY READS	PFC FRYER
1) Put food in basket 2) Open door 3) Set basket on basket lift 4) Close door 5) Enter cook time and press START , ex 1 3 0 START 6) Wait for “Beep” 7) Open door 8) Remove basket	 	4) LCD displays SELECT TIME/ START 5) Drawer loads food into oil 6) COOKING cycle begins 7) Fryer counts down time remaining 8) Basket raises out of oil 9) Food drains (time adjustable) 10) Fryer “beeps” to let you know that food is cooked 11) Fryer dumps food into warming tray

PRESET TIMES

COOKING TIMES & NAMES (factory defaults)								
Preset	Name	Time	Preset	Name	Time	Preset	Name	Time
1	French Fries	3:00	4	Poppers	3:00	7	Fish Fillets	4:00
2	Chicken Tenders	4:00	5	Cheese Bites	2:00	8	Chicken Wings	4:00
3	Onion Rings	2:30	6	Corn Dogs	3:00	9	Chicken & Fries	4:00

*NOTE: Pressing **PRESET** repeatedly will toggle between MANUAL mode, PRESET mode and PRESET LOCKED mode.*

NOTE: The default presets are programmed and displayed to show you the fryers capabilities. We recommend that you change the presets to match your own requirements.

PRESET MODE

OPERATOR ACTION	DISPLAY READS	PFC FRYER
<ol style="list-style-type: none"> Put food in basket Open door Set basket on basket lift Close door Press PRESET 		<ol style="list-style-type: none"> Now in PRESET mode LCD displays PRESET
<ol style="list-style-type: none"> Press 1 (for example) Cook cycle starts automatically <p><i>Note: You can choose between 9 different presets</i></p>		<ol style="list-style-type: none"> LCD displays FRENCH FRIES (default is 3:00) Brief pause, basket lowers into oil COOKING cycle begins Fryer counts down time remaining
<ol style="list-style-type: none"> Wait for “Beep” Open door Remove basket Follow steps 1 through 6 to cook another order this way 		<ol style="list-style-type: none"> COOKING cycle is complete Basket raised out of oil Food drains Fryer “beeps” to let you know that food is cooked Fryer returns to READY mode Fryer returns to MANUAL mode

PRESET LOCKED MODE

OPERATOR ACTION	DISPLAY READS	PFC FRYER
<ol style="list-style-type: none"> Press PRESET + PRESET 		<ol style="list-style-type: none"> Now in PRESET LOCK mode PRESET is displayed on LCD
<ol style="list-style-type: none"> Put food in basket Open door Set basket on basket lift Close door Press 2 (for example) Cook cycle starts automatically 		<ol style="list-style-type: none"> LCD displays 4:00 (for example) Brief pause, basket lower into oil COOKING cycle begins. Fryer counts down time remaining
<ol style="list-style-type: none"> Wait for “Beep” Open door Remove basket Follow steps 2 through 6 to cook another order this way 		<ol style="list-style-type: none"> COOKING cycle is complete Basket raises out of oil Food drains Fryer “beeps” to let you know that food is cooked <p><i>Note: Still in PRESET mode</i></p>

COOK TIME CORRECTION

OPERATOR ACTION	DISPLAY READS	PFC FRYER
<ol style="list-style-type: none"> 1) Enter incorrect cooking time (4:30 instead of 3:30 for example) 2) Press 4 3 0 START 		<ol style="list-style-type: none"> 1) Brief pause, basket lowers into oil 2) COOKING cycle begins 3) Fryer counts down time remaining
<ol style="list-style-type: none"> 3) Press CANCEL 		<ol style="list-style-type: none"> 4) COOKING cycle PAUSE 5) Basket raises out of oil
<ol style="list-style-type: none"> 4) Press CANCEL to erase cooking time 		<ol style="list-style-type: none"> 6) Cooking time erased, now in READY mode
<ol style="list-style-type: none"> 5) Enter correct cooking time 6) Press 1 3 0 START 		<ol style="list-style-type: none"> 7) Brief pause, basket lowers into oil 8) COOKING cycle begins. 9) Fryer counts down time remaining

OPEN DOOR - PAUSED COOK CYCLE

(Safety and Health regulations require doors and panels to be closed during cooking)

OPERATOR ACTION	DISPLAY READS	PFC FRYER
<ol style="list-style-type: none"> 1) Open door during product loading 		<ol style="list-style-type: none"> 1) COOKING cycle PAUSE 2) Basket raises out of oil
<ol style="list-style-type: none"> 2) Close door and press START if you want the cooking cycle to continue 		<ol style="list-style-type: none"> 3) Brief pause, basket lowers into oil 4) COOKING cycle begins 5) Fryer counts down time remaining
<ol style="list-style-type: none"> 3) Close door and press CANCEL if you do not want the cooking cycle to continue 		<ol style="list-style-type: none"> 6) Cooking time erased, now in READY mode

STANDBY MODE

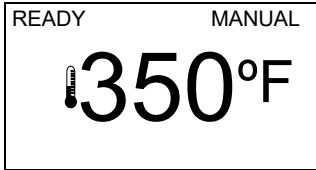
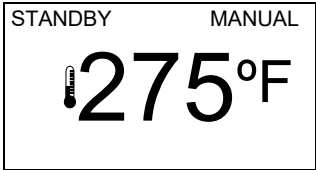
DISPLAY READS	OPERATOR ACTION	DISPLAY NOW READS
 <p>READY MANUAL 350°F</p>	<ol style="list-style-type: none"> 1) Press ON/OFF and CANCEL together 2) Release both. <p>NOTE: Temperature will decrease to 275°F (to set default standby temperature)</p>	 <p>STANDBY MANUAL 275°F</p>

Note: During slow periods, using standby mode reduces energy costs, allows a quick recovery and minimizes oil breakdown.

SHUTTING DOWN

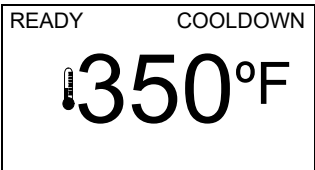
OPERATOR ACTION	DISPLAY READS	PFC FRYER
<p>TURN YOUR PERFECT FRY OFF:</p> <ul style="list-style-type: none"> • At end of day • To replace deep fry oil • To clean • For other service or maintenance 	 <p>READY MANUAL 350°F</p>	<ol style="list-style-type: none"> 1) Now in READY mode
<ol style="list-style-type: none"> 1) Press ON/OFF 	 <p>READY COOLDOWN 350°F</p>	<ol style="list-style-type: none"> 2) Now in COOLDOWN mode 3) No power to heater element 4) Fans continue to cool fryer 5) Fryer counts down temperature 6) LCD backlighting goes off
<p>DO NOT UNPLUG FRYER</p> <p>Fans must remain ON during COOLDOWN mode</p>		<ol style="list-style-type: none"> 7) Temperature decreases to 122 °F (50°C) 8) Fans stop 9) LCD goes blank 10) Your Perfect Fry unit is off

USER DEFINED OPTIONS

CUSTOMIZE YOUR Perfect Fry unit WITH YOUR OWN SETTINGS

- CTS™ Cook Time Sensitivity
- Temperature read-out: °C or °F
- Preset Cooking Times
- Cooking Oil Standby Temperature
- Count of Cook Cycles
- Cooking Oil Temperature
- Basket Drain Time
- Sound Volume
- And Much More

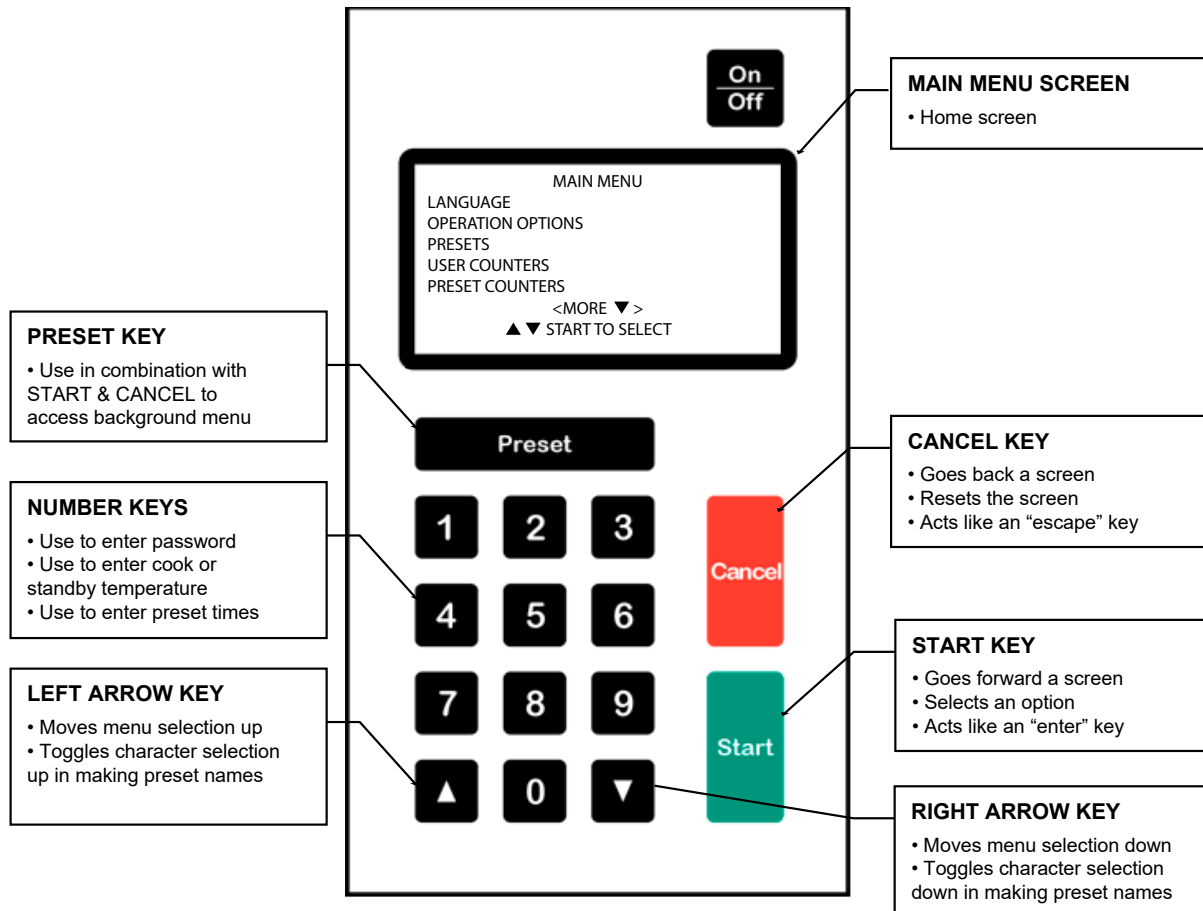

BACKGROUND MENU - ACCESSING

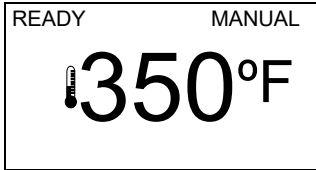
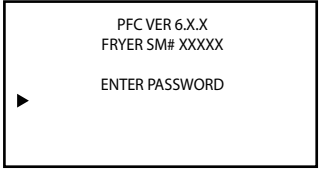
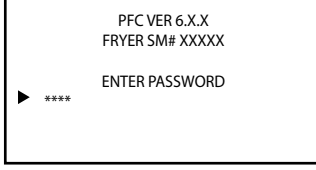
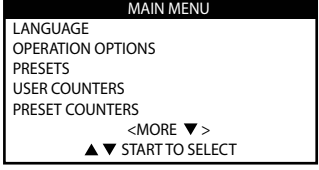
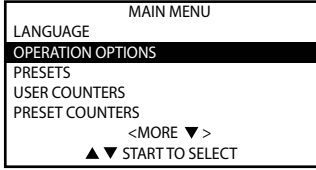
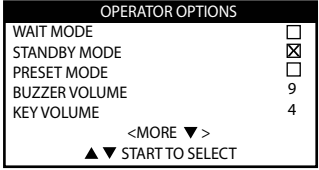
DISPLAY READS	OPERATOR ACTION	DISPLAY NOW READS
	<ol style="list-style-type: none"> 1) Press CANCEL START PRESET together 2) Release together 	
	<ol style="list-style-type: none"> 3) Press 4 7 5 0 START 	
	<ol style="list-style-type: none"> 4) Scroll down to the desired menu selection and press START 	

CTS™ (COOK TIME SENSITIVITY)

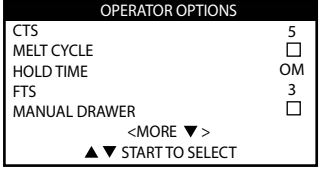
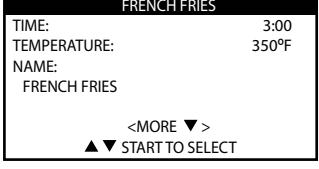
<ul style="list-style-type: none"> • CTS™ adjusts cooking time to compensate for the drop in cooking oil temperature when a basket of product is placed into the fryer. CTS™ increases cooking time to accommodate for differences in product moisture content, basket-load size, and initial temperature. • A proper CTS™ setting will ensure a high quality product. For example; 2 lbs of French fries will cook to the same quality as only 6 ounces of French Fries. • In addition to having a “global” CTS™ setting under the Operation Options menu for manually entered cook cycles, each preset can be programmed with its own individual setting. This provides for a lot of flexibility among different food products. • Some experimenting with the range of 1 to 9 may be required to achieve optimum quality. A value of 5 is a good place to start and is the default. • A setting of 0 means no CTS™ whatsoever. 	 
---	--

BACKGROUND MENU MAP

LANGUAGE

- ▶ ENGLISH (factory default)
- ▶ ESPANOL
- ▶ FRANCAIS

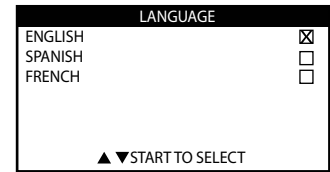

OPERATOR OPTIONS

- ▶ WAIT MODE
 - When , will not allow cooking until oil has reached operating temperature
 - Default is
- ▶ STANDBY MODE
 - When gives user ability to put fryer into standby mode
 - This is an energy saving feature which holds oil temperature at desired standby temperature
 - Default is

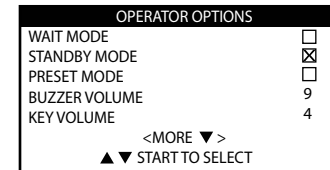

- ▶ BUZZER VOLUME
 - Intensity of “beep” for finish of cook cycle and system errors
 - Choose between 0 and 9
 - Default is 9
- ▶ KEY VOLUME
 - Intensity of “beep” when key is pressed
 - Choose between 0 and 9
 - Default is 4

- ▶ UNITS
 - Temperature of oil in the vat
 - Choose between °C (Celsius) and °F (Fahrenheit)

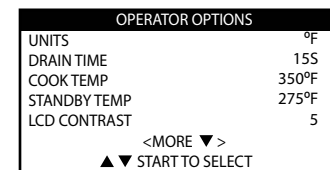

- ▶ DRAIN TIME
 - Time a basket of cooked food sits out of the oil before finishing the cook cycle
 - Choose between 0 and 30 seconds
 - Default is 15 seconds

OPERATOR OPTIONS - CONTINUED

▶ COOK TEMPERATURE

- Operating temperature of the oil
- Choose between 275°F (135°C) and 375°F (190°C)
- Note: Between 350°F and 360°F (177°C and 182°C) is ideal. If the temperature is set too low, the food will absorb too much oil and taste greasy. If the temperature is set too high, the food will cook too quickly on the outside and will be too dark once the inside is cooked. It may also cause the oil to breakdown quicker and cause smoking.
- Default is 350°F (177°C)

▶ STANDBY TEMPERATURE

- Oil temperature when fryer is in standby mode
- Choose between low (ambient room temperature) and high (cook temperature)
- Default is 275°F (135°C)

▶ LCD CONTRAST

- Visibility of screen
- Choose between 0 and 9

▶ CTS™ COOK TIME SENSITIVITY

- Adjusts cooking time to compensate for drop in cooking oil temperature when basket of product is placed into fryer.

OPERATOR OPTIONS	
CTS	5
REMINDER TIME	0M
MELT CYCLE	<input type="checkbox"/>
FACTORY SETUP	
<MORE ▼>	
▲▼ START TO SELECT	

▶ REMINDER TIME

- Time elapsed after cook cycle is finished
- Reminds operator to remove product after it has finished cooking
- “Beeps” and displays “PRODUCT READY” on LCD
- Choose between 0 and 99 minutes
- Default is 0 (disabled)

▶ MELT CYCLE

- When , fryer will gradually melt solid blocks of shortening until temperature reaches 212°F (100°C). It is designed to prevent scorching shortening and overheating element.
- Press **ON/OFF** to cancel and heat regularly. **DO NOT CANCEL IF USING SOLID SHORTENING!**
- Default is

PRESETS

- ▶ 1 FRENCH FRIES
- ▶ 2 CHICKEN TENDERS
- ▶ 3 ONION RINGS
- ▶ 4 POPPERS
- ▶ 5 CHEESE BITES
- ▶ 6 CORN DOGS
- ▶ 7 FISH FILLETS
- ▶ 8 CHICKEN WINGS
- ▶ 9 POTATO WEDGES

PRESETS	
1 FRENCH FRIES	3:00
2 CHICKEN TENDERS	4:00
3 ONION RINGS	2:30
4 POPPERS	3:00
5 CHEESE BITES	2:00
<MORE ▼>	
▲▼ START TO SELECT	

PRESETS	
6 CORN DOGS	3:00
7 FISH FILLETS	4:00
8 CHICKEN WINGS	4:00
9 POTATO WEDGES	3:30
<MORE ▼>	
▲▼ START TO SELECT	

Preset properties that can be changed

- ▶ TIME
 - Cook Cycle Time
- ▶ TEMP
 - Cook Cycle Temperature
- ▶ CTS
 - Cook Time Sensitivity
- ▶ NAME
 - Preset Name

FRENCH FRIES	
TIME:	3:00
TEMPERATURE:	350°F
CTS	5
NAME:	
FRENCH FRIES	
<MORE ▼>	
▲▼ START TO SELECT	

USER COUNTERS

- ▶ COOK TIME
 - Accumulated cook cycle time in hours
- ▶ NUMBER OF CYCLES
 - Accumulated number of cook cycles
- ▶ ON TIME
 - Accumulated on time in hours
- ▶ RESET ALL
 - To reset all values to 0

USER COUNTERS		
COOK TIME		0HR
NO CYCLES		0
ON TIME		0HR
RESET ALL		
▲▼ START TO SELECT		

PRESET COUNTERS

- ▶ NUMBER OF CYCLES
 - Accumulated number of cook cycles
- ▶ RESET ALL
 - To reset all values to 0

PRESET COUNTERS		
1 FRENCH FRIES		115
2 CHICKEN TENDERS		230
3 ONION RINGS		138
4 POPPERS		221
5 CHEESE BITES		121
<MORE ▼>		
▲▼ START TO SELECT		

PRESET COUNTERS		
6 CORN DOGS		32
7 FISH FILLETS		56
8 CHICKEN WINGS		223
9 PTOTAO WEDGES		61
RESET ALL		
<MORE ▼>		
▲▼ START TO SELECT		

TOTAL COUNTERS

- ▶ COOK TIME
 - Accumulated cook cycle time in hours, cannot be reset
- ▶ NUMBER OF CYCLES
 - Accumulated number of cook cycles, cannot be reset
- ▶ ON TIME
 - Accumulated on time in hours, cannot be reset

TOTAL COUNTERS		
COOK TIME		0HR
NO CYCLES		0
ON TIME		0HR
▲▼ START TO SELECT		

OPERATION TESTS (for service personnel)

▶ FANS

- Use the arrow keys to turn fans on and off [note: oil temperature must be below 122°F (50°C)]
- Monitor rpm and current values of each fan

▶ INTERLOCKS

- To view interlocks and if they're open or closed
- = open, = closed

▶ BASKET

- Use the arrow keys to move basket up and down
- Monitor current values of motor

▶ DRAWER

- N/A (for PFA models only)

▶ HEATER

- For factory heater calibration. **Do not adjust.**

▶ DISPLAY

- Use START and CANCEL to turn all the pixels of the LCD on and off

▶ CIRCUIT BOARD

- Monitor the circuit board temperature

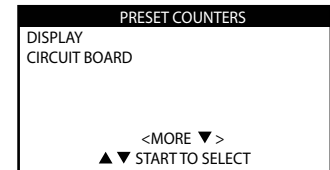
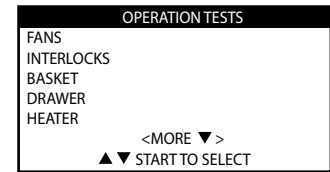

SET DEFAULTS

- Press start to reset options and presets to factory defaults
- PRESETS and UNITS will not change

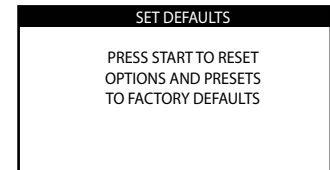





OPTION CHANGES

Example °F to °C)

DISPLAY READS	OPERATOR ACTION	DISPLAY NOW READS
	<ol style="list-style-type: none"> 1) From OPERATION OPTIONS menu, scroll down to UNITS using ▼ key 2) Press START 	

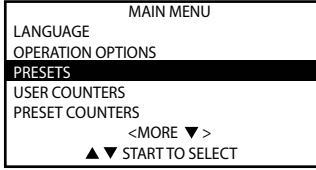
Note: All OPERATION OPTIONS menu items can be customized by following this basic procedure (some use the arrow keys).

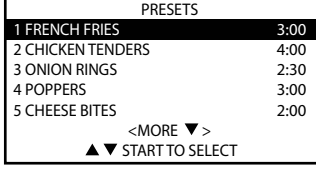
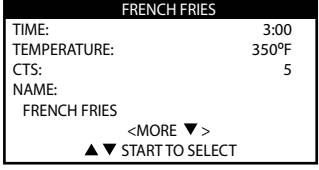
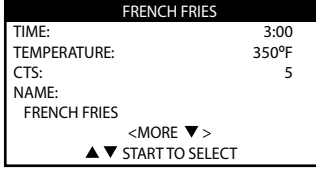
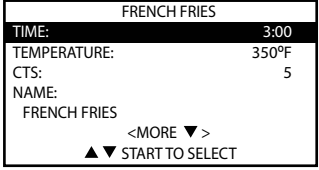
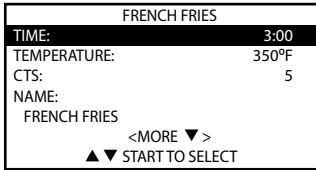
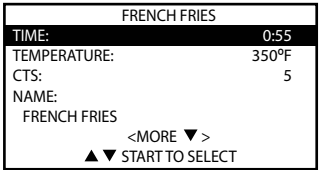
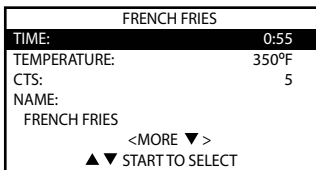
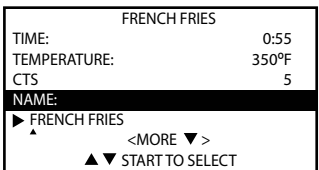
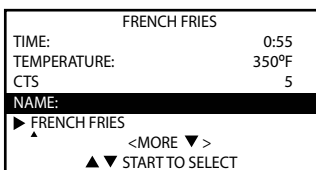
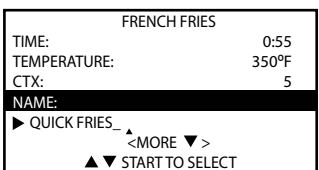
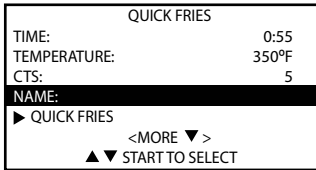
CUSTOMIZING PRESETS

DISPLAY READS	OPERATOR ACTION	DISPLAY NOW READS
 <p>MAIN MENU LANGUAGE OPERATION OPTIONS PRESETS USER COUNTERS PRESET COUNTERS <MORE ▼> ▲▼ START TO SELECT</p>	<p>1) From main menu, scroll down to PRESETS using ▼ KEY. 2) Press START</p>	 <p>PRESETS 1 FRENCH FRIES 3:00 2 CHICKEN TENDERS 4:00 3 ONION RINGS 2:30 4 POPPERS 3:00 5 CHEESE BITES 2:00 <MORE ▼> ▲▼ START TO SELECT</p>
 <p>PRESETS 1 FRENCH FRIES 3:00 2 CHICKEN TENDERS 4:00 3 ONION RINGS 2:30 4 POPPERS 3:00 5 CHEESE BITES 2:00 <MORE ▼> ▲▼ START TO SELECT</p>	<p>3) Change PRESET 1's settings by scrolling down using the ▼ KEY. 4) Press START</p>	 <p>FRENCH FRIES TIME: 3:00 TEMPERATURE: 350°F CTS: 5 NAME: FRENCH FRIES <MORE ▼> ▲▼ START TO SELECT</p>
 <p>FRENCH FRIES TIME: 3:00 TEMPERATURE: 350°F CTS: 5 NAME: FRENCH FRIES <MORE ▼> ▲▼ START TO SELECT</p>	<p>5) Change PRESET 1's cook time by scrolling down using the ▼ KEY. 6) Press START</p>	 <p>FRENCH FRIES TIME: 3:00 TEMPERATURE: 350°F CTS: 5 NAME: FRENCH FRIES <MORE ▼> ▲▼ START TO SELECT</p>
 <p>FRENCH FRIES TIME: 3:00 TEMPERATURE: 350°F CTS: 5 NAME: FRENCH FRIES <MORE ▼> ▲▼ START TO SELECT</p>	<p>7) Set new COOK TIME (ex: 55 seconds) 8) Press 5 5 START</p>	 <p>FRENCH FRIES TIME: 0:55 TEMPERATURE: 350°F CTS: 5 NAME: FRENCH FRIES <MORE ▼> ▲▼ START TO SELECT</p>
 <p>FRENCH FRIES TIME: 0:55 TEMPERATURE: 350°F CTS: 5 NAME: FRENCH FRIES <MORE ▼> ▲▼ START TO SELECT</p>	<p>9) Change PRESET 1's name by scrolling down using the ▼ KEY. 10) Press START (a small cursor appears under first letter of the name PRESET 1)</p>	 <p>FRENCH FRIES TIME: 0:55 TEMPERATURE: 350°F CTS: 5 NAME: ▶ FRENCH FRIES ▲ <MORE ▼> ▲▼ START TO SELECT</p>
 <p>FRENCH FRIES TIME: 0:55 TEMPERATURE: 350°F CTS: 5 NAME: ▶ FRENCH FRIES ▲ <MORE ▼> ▲▼ START TO SELECT</p>	<p>11) To change character above small cursor, use the ▼ or ▲ keys 12) Press START to move forward 13) Press CANCEL to move back 14) To enter your selection press START after underscore mark (_) appears</p>	 <p>FRENCH FRIES TIME: 0:55 TEMPERATURE: 350°F CTX: 5 NAME: ▶ QUICK FRIES_ ▲ <MORE ▼> ▲▼ START TO SELECT</p>
 <p>QUICK FRIES TIME: 0:55 TEMPERATURE: 350°F CTS: 5 NAME: ▶ QUICK FRIES <MORE ▼> ▲▼ START TO SELECT</p>	<p>15) QUICK FRIES now appears on bottom left of LCD during PRESET models NOTE: maximum 20 characters</p>	 <p>COOKING PRESET 0:55 QUICK FRIES</p>

CUSTOMIZING PRESETS ON THE FRONT LABEL

Used in conjunction with your custom programmed presets, easily identify your own custom presets by using the supplied label page. Simply follow the steps below:

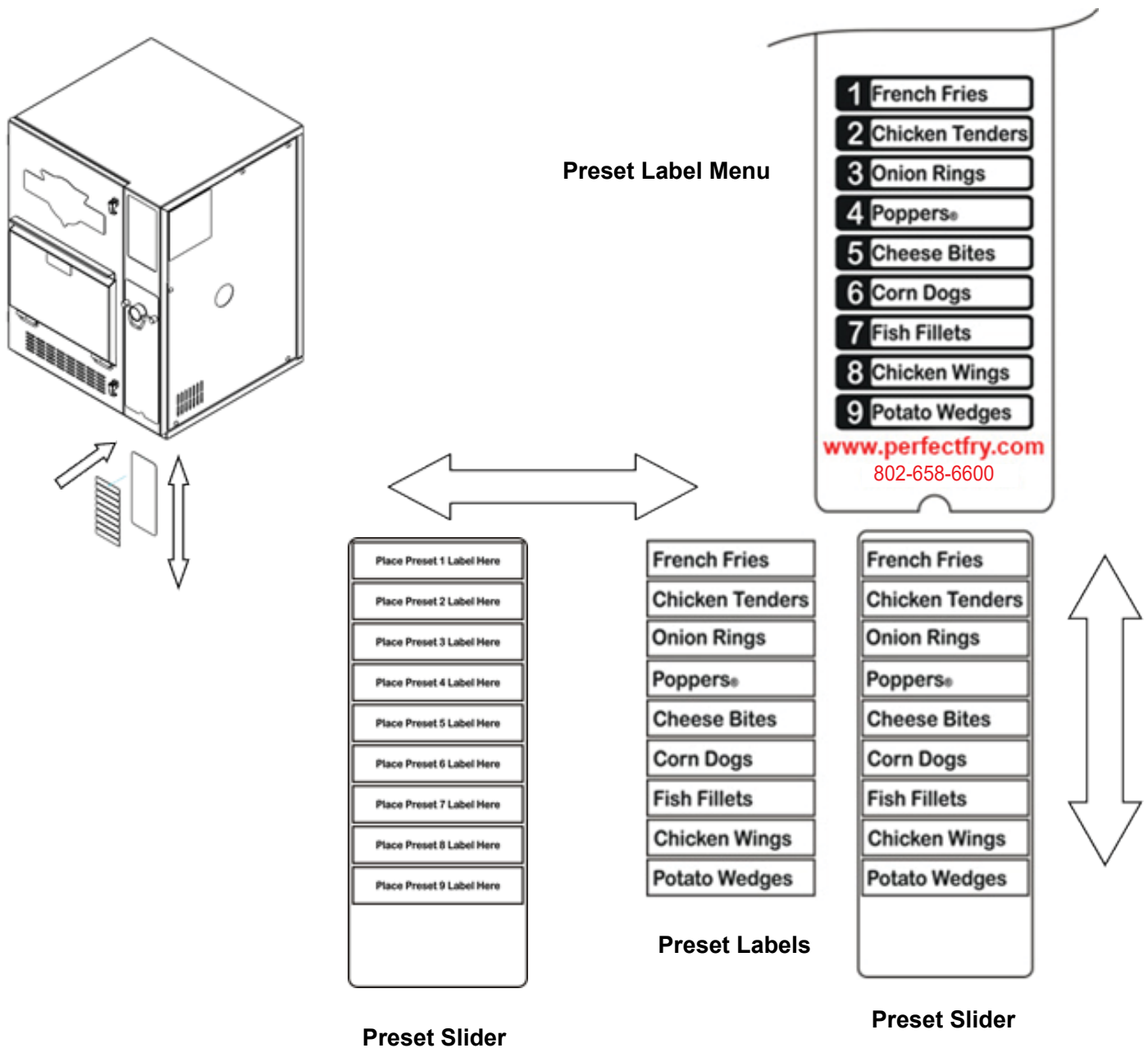

1. Remove preset slider (default presets are located on front and custom preset label template is located on back).
2. Choose preprinted labels or create your own label from supplied label sheet.
3. Apply labels to preset slider in proper preset box (up to 9 labels corresponding to 9 programmed presets may be used on preset slider).
4. Install preset slider under preset menu label by starting from bottom.





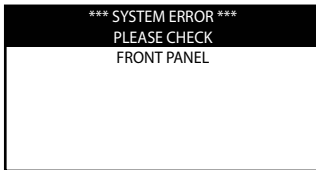
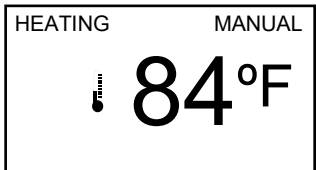
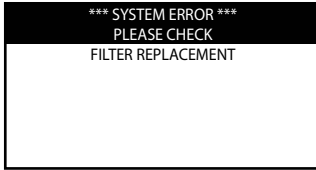
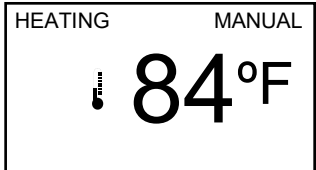
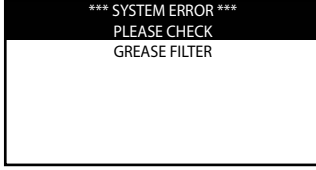
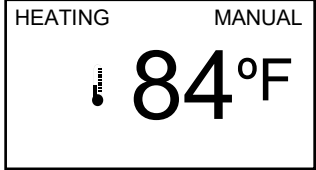

HELP

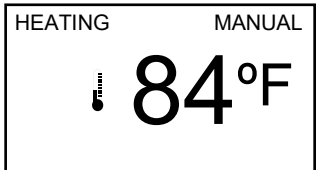
- Before opening the front panel, make sure the oil has cooled to below 122°F (50°C).
- Your Perfect Fry unit “beeps” twice to signal an error condition. When the error condition is corrected, two beeps signal OK.
- It is possible to have more than one SYSTEM ERROR displayed at the same time. When that happens, all error conditions will be displayed on the LCD. All must be corrected.
- When a SYSTEM ERROR condition exists, the PERFECT FRY de-energizes the heating element, but the fans continue to run.
- When there appears to be a problem, but no SYSTEM ERROR message is displayed, refer to the troubleshooting table. If the solution suggested doesn’t solve the problem, call your service rep. or PERFECT FRY at 802-658-6600



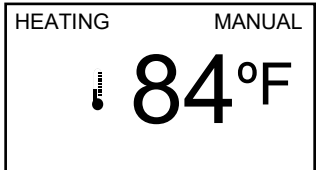

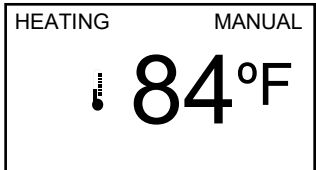
SYSTEM ERROR CONDITIONS

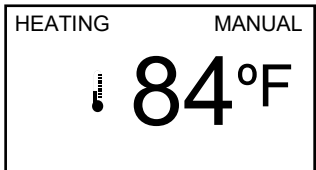
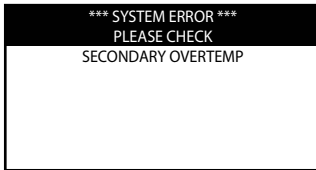
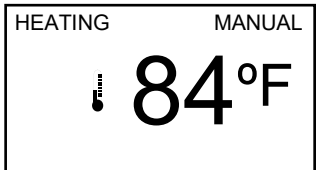
DISPLAY READS	OPERATOR ACTION	DISPLAY NOW READS
	<ul style="list-style-type: none"> • Hinged front panel is not installed or shut properly • Check to see that front panel is closed securely with two black latches 	
	<ul style="list-style-type: none"> • Air filter cartridge is not installed properly • Check to make sure cartridge is properly installed (▲▲ up) in air filter cage, and cage is securely latched in place 	
	<ul style="list-style-type: none"> • Grease filter is not installed properly • Check to see that it sits in grease tray (magnet on right hand end of grease filter), and that filter and tray are properly installed in filter chamber 	
	<ul style="list-style-type: none"> • Heating Element is not installed properly • Check to see that heater module has been properly placed on oil vat • Check to see the electrical connection between heater module and connector is made at inside back of fryer compartment • Clean the male and female terminals on connector with rubbing alcohol and cotton swab 	

SYSTEM ERROR CONDITIONS (CONTINUED)

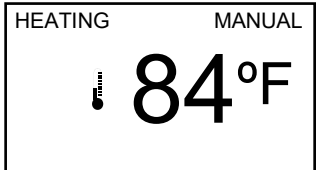
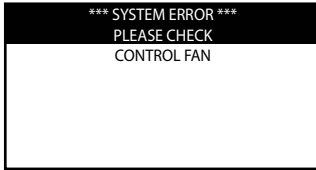
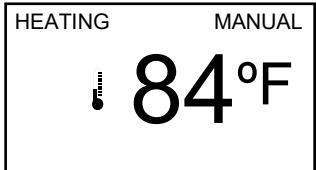
DISPLAY READS	OPERATOR ACTION	DISPLAY NOW READS
	<ul style="list-style-type: none"> • There is improper air flow • Make sure air intake (front) and exhaust (rear) vents are not obstructed • Clean grease filter thoroughly • Replace the air filter cartridge 	
	<ul style="list-style-type: none"> • Loss of pressure in the Fire Extinguisher, system needs to be recharged • Call PERFECT FRY at 802-658-6600 for recommended fire Service Company near you. 	
	<ul style="list-style-type: none"> • Heating Element is not installed properly • Check to see that heater module has been properly placed on oil vat • Check to see the electrical connection between heater module and connector is made at inside back of fryer compartment • Clean the male and female terminals on connector with rubbing alcohol and cotton swab 	
	<ul style="list-style-type: none"> • Cooking oil level is too low. • Make sure oil level is between the hot and cold lines at rear of vat. • Cooking oil has overheated. • Press ▼ and ▲ keys together and release to reset • Is it possible the heater module was submerged in water? If so, call 802-658-6600. 	

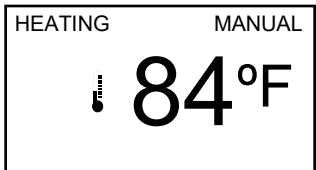
SYSTEM ERROR CONDITIONS (CONTINUED)

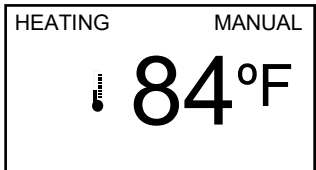
DISPLAY READS	OPERATOR ACTION	DISPLAY NOW READS
	<ul style="list-style-type: none"> • Main ventilation fan is not functioning properly • Check main ventilation fan to see if it is moving air and the fan blades are moving • Remove obstruction and/or check electrical connection 	
	<ul style="list-style-type: none"> • Control fan is not functioning properly • Check control fan to see if it is moving air and the fan blades are moving • Remove obstruction and/or check electrical connection 	
	<ul style="list-style-type: none"> • Electronics box fan is not functioning properly • Check main ventilation fan to see if it is moving air and the fan blades are moving • Remove obstruction and/or check electrical connection 	
	<ul style="list-style-type: none"> • Basket motor has been obstructed • Check for cause of obstruction before returning fryer to normal use • Correct cause of obstruction 	

TROUBLESHOOTING TABLE

PROBLEM	PROBABLE CAUSE	PROBABLE SOLUTION
Won't turn on when you press the ON/OFF key	<ol style="list-style-type: none"> 1. Not plugged in 2. Circuit breaker or fuse 3. Wiring 	<ol style="list-style-type: none"> 1. Plug in fryer 2. Check circuit breaker or replace fuse 3. Make sure Perfect Fry unit is plugged in according to its electrical specifications
ON but will not heat	<ol style="list-style-type: none"> 1. Connector on heater module 2. Electronics box module 	<ol style="list-style-type: none"> 1. Replace heater module 2. Replace electronics box module
Baskets will not lower into or rise out of cooking oil.	<ol style="list-style-type: none"> 1. Basket lift not working 2. Motor not working 	<ol style="list-style-type: none"> 1. Make sure that the basket lift is installed properly 2. Check wiring 3. Replace Motor
Outer surface is unusually hot	<ol style="list-style-type: none"> 1. Dirty grease filter 2. Air filter cartridge plugged 3. Fans not operating 	<ol style="list-style-type: none"> 1. Remove and clean grease filter 2. Replace air filter cartridge 3. Check rear of fryer for air flow
Cooking oil spills into spill tray, excessively	<ol style="list-style-type: none"> 1. Too much oil in vat 2. Too much ice or water in food 3. Too much food in basket 4. Oil has reached end of its life 	<ol style="list-style-type: none"> 1. Remove some oil (when oil is cold it should not be above cold oil line inside vat) 2. Cook only frozen foods recommended for use in deep fryers; remove excess ice from food before placing food in basket 3. Do not fill food above top of basket 4. Change oil
Food floats out of basket	<ol style="list-style-type: none"> 1. Too much cooking oil in vat. 	<ol style="list-style-type: none"> 1. Remove some oil; do not fill above cold oil line.
Excessive smoking	<ol style="list-style-type: none"> 1. Oil has "broken down" 2. Moisture 	<ol style="list-style-type: none"> 1. Replace the cooking oil 2. Too much moisture or ice crystals
Excessive foaming	<ol style="list-style-type: none"> 1. Soap residue 2. Oil has "broken down" 	<ol style="list-style-type: none"> 1. Rinse parts with vinegar solution 2. Replace the cooking oil

PFS AUTOMATIC EXTINGUISHER

NOTE: Please refer to the PFS Automatic Extinguisher Installation, Inspection, Maintenance & Recharge Manual (L20-361) for more detailed information.



CAUTION The PFS must be stored above 32°F (0°C)

1. GENERAL DESCRIPTION

The PFS consists of a cylinder assembly (with pressure switch and gauge), actuating lever, fusible link assembly, manual pull station, and two nozzles. It is designed and acceptable for use in areas that have ambient conditions between 32°F (0°C) and 50°C (120°F).

2. OPERATION

Automatic Operation

Upon the detection of a fire, the PFS will automatically operate. The fusible link rated at 280°F (138°C) will operate when exposed to the fire and operate the PFS automatic extinguisher unit. When operated, the PFS unit will discharge wet chemical agent through the provided discharge piping and distribution nozzles.

Manual Operation

The PFS unit can also be operated manually by pulling the remote lever (to be mounted on the front of the cooking appliance) that is clearly marked “In Case Of Fire - PULL”.

IMPORTANT:

The manual pull handle is to be pulled **ONLY IN CASE OF FIRE** in the Perfect Fry unit (use when the automatic system has failed).



NOTE: Power shut-off is also achieved by system operation. If the pressure in the cylinder(s) drops below 92 psi (6.3 bar), the pressure switch opens, deactivating the power relay causing the appliance to de-energize.

3. INSPECTION & MAINTENANCE

The PFS Automatic Extinguisher must be serviced on a regular basis. Three types of servicing are required by NFPA 17A:

Monthly

An inspection or “quick check” must be conducted by the owner/operator and include verification of the following:

1. The PFS is in its proper location.
2. The PFS shows no physical damage or condition that might prevent operation.
3. The pressure gauge is in the green operating range.
4. The maintenance tag is in place and is up to date.
5. The manual pull is unobstructed.
6. The nozzle blow-off caps are intact and undamaged.
7. At least monthly, the date the inspection is performed and the initials of the person performing the inspection shall be recorded.

Semi-Annually

Maintenance must be conducted by a service technician that is trained and shall have passed a written or online test that is acceptable to the authority having jurisdiction. Maintenance shall be performed at intervals no more than 6 months apart as outlined in NFPA 17A and shall include the following::

1. A check to see that the hazard has not changed.
2. Examination of the fusible link, cylinder, tubing, nozzles and all auxiliary equipment.
3. Fusible links must be replaced at least Semi-annually from the date of installation. They must be destroyed when removed. Only use Perfect Fry part number: 83089, in the detection line. A fusible link loaded with grease or other material can result in an excessive delay in actuation.
4. Verification that the agent distribution piping is not obstructed. Remove the blow-off caps (83108) from the nozzles to ensure that they are free of grease build-up and inspect them for deterioration. Replace them as necessary.

- 5. Where semi-annual maintenance of any wet chemical containers or PFS components reveals conditions such as, but not limited to, corrosion or pitting in excess of manufactured limits, structural damage or fire damage, repairs by soldering, welding, or brazing, the affected part(s) shall be replaced or hydrostatically tested. The hydrostatic testing of wet chemical containers shall follow the applicable procedures outlined in NFPA 17A.
- 6. All wet chemical systems must be tested for proper operation, which shall include operation of the detection system signals and releasing devices, including the manual pull station and other associated equipment. A discharge of the wet chemical is not a required part of the test.
 - a. Simply disconnect one lead from the pressure switch to initiate appliance shut-down.
- 7. Where the maintenance of the PFS reveals defective parts that could cause an impairment or failure of proper operation of the PFS, the affected parts must be replaced or repaired.

- 8. The maintenance report, with recommendations if any, shall be filed with the owner or with the designated party responsible for the PFS.
- 9. The PFS must have a tag or label indicating the month and year the maintenance is performed and identifying the person performing the service. Only the current tag or label must remain in place.

Twelve Years

Maintenance must be done by authorized service personnel, as per NFPA 17A and include the following:

- 1. The wet chemical extinguishing agent must be removed and discarded.
- 2. The cylinder needs to be hydrostatically tested to 300 psi (21 bar).
- 3. If the cylinder shows no signs of rupture or distortion, recharge the PFS as directed in the recharging instructions.

SEMI-ANNUAL INSPECTION & MAINTENANCE (I & M) LOG: PERFECT FRY Serial No. _____

Date _____ I & M by _____	Date _____ I & M by _____
Date _____ I & M by _____	Date _____ I & M by _____
Date _____ I & M by _____	Date _____ I & M by _____
Date _____ I & M by _____	Date _____ I & M by _____
Date _____ I & M by _____	Date _____ I & M by _____
Date _____ I & M by _____	Date _____ I & M by _____
Date _____ I & M by _____	Date _____ I & M by _____
Date _____ I & M by _____	Date _____ I & M by _____
Date _____ I & M by _____	Date _____ I & M by _____
Date _____ I & M by _____	Date _____ I & M by _____
Date _____ I & M by _____	Date _____ I & M by _____



DECLARATION OF CONFORMITY



(FOR CE PERFECT FRY ONLY)

Application of Council Directive(s):

**Low Voltage Directive (93/68/EEC & 72/23/EEC)
EMC Directive (2004/108/EC & 89/336/EEC)
WEEE Directive (2002/96/EC)
RoHS Directive (2002/95/EC)**

Standard(s) to which Conformity is Declared:

**EN 60335-1, EN 60335-2-37
EN 61000-6-1, EN 61000-6-3**

Manufacturer's Name

Perfect Fry Company LLC

Manufacturer's Address:

**42 Allen Martin Drive
Essex Junction, VT USA
05452**

Importer's Name

Importer's Address

Type of Equipment

Commercial Electric Deep Fat Fryer

Model Number:

Serial Number:

Year of Manufacture:

I, the undersigned, hereby declare that the equipment specified above conforms to the above Directive(s) and Standard(s)

Place: Perfect Fry Company
Essex Junction, VT, USA

_____ (Signature)

Date: ___ / ___ / ___

_____ (Full Name)

_____ (Position)

ORIGINAL STANDARD EQUIPMENT LIMITED WARRANTY

US & CANADA

Effective January 1, 2018, Serial Number E18AA000000

GENERAL WARRANTY

Perfect Fry warrants to the original purchaser of its commercial cooking appliances and related equipment that said appliances and related equipment will be free from defects in material and workmanship under normal use for a period of one (1) year from the date of installation, with appropriate documentation, to a maximum of fifteen (15) months from the date of manufacture, subject to the following additions, exceptions, exclusions and limitations.

WHAT IS COVERED

This warranty is limited to the repair or replacement at the Company's option, without charge, of any part found to be defective within the warranty period and reasonable expenses incurred for freight and material for the installation of such part; in addition, the Company's obligation shall be limited to reimbursement for normal labor on such parts.

Perfect Fry, Inc. agrees to pay the Authorized Service and Parts Distributor, for any labor and material required to repair or replace, at the Company's option, any part which may fail due to defects in material or workmanship during the above general warranty period.

ADDITIONAL PART ONLY WARRANTY

After the end of the above general warranty, the computer is warranted to be free of defects for an additional one (1) year. This additional warranty only covers the cost of the part. Customer is responsible for all labor and shipping costs during this warranty period.

HOW TO KEEP YOUR WARRANTY IN FORCE

- Make sure any shipping damages are reported immediately. Damages of this nature are the responsibility of the carrier and must be reported by the receiver.
- Install the appliance properly. This is the responsibility of the installer and the procedures are outlined in the manual.
- Register your equipment at www.perfectfry.com. This is necessary to start your warranty and to obtain the unlock code for the computer. The unlock code will be sent via email.
- Do not install the appliance in a home or residence.
- Maintain the appliance properly. This is the responsibility of the purchaser of the appliance and the procedures are outlined in the manual.
- Replace the air filter at regular intervals to prevent filter saturation. Record when the air filter is replaced in the Installation & Operations Manual. Also regularly inspect the door gasket for gaps, cracks and tears. Failure to do so could result in a non-warranty main fan failure due to grease build up.
- Adjustments, such as calibration, leveling, tightening of fasteners or plumbing or electrical connections normally associated with initial installation are outlined in the manual and are not covered under warranty.
- Damages as a result of fire, flood or other acts of God are not covered under this warranty.
- Use the appliance for what it is intended. If the appliance is used for a purpose other than for which it was intended or designed, resulting damages are not covered under the warranty.
- Make sure that the appliance has the correct voltage. If a failure is due to incorrect or erratic voltage, these damages are not covered under the warranty.
- Do not materially alter or modify the appliance.
- Do not obliterate, remove or alter the serial number rating plate.

- Use only Genuine OEM parts from Perfect Fry or its Authorized Parts and Service Distributors. Repairs are not covered by the warranty if non-OEM parts or non-Authorized Parts and Service Distributors are used.
- Failures that are not attributable to a defect in materials or workmanship are not covered.

This warranty specifically excludes parts which wear or would be replaced under normal usage, including, but not limited to, electric lamps, fuses, interior or exterior finishes, filters and gaskets.

LIMITS TO THE WARRANTY

Charges for mileage over one hundred (100) miles and travel time over two (2) hours from the Authorized Service and Parts Distributor are not covered under this warranty. Extended mileage charges are the responsibility of the individual or firm requesting these services.

If any oral statements have been made regarding the appliance, these statements do not constitute warranties and are not part of the contract of sale. This limited warranty constitutes the complete, final and exclusive statement with regard to warranties.

THIS LIMITED WARRANTY IS EXCLUSIVE AND IS IN LIEU OF ALL OTHER WARRANTIES WHETHER WRITTEN, ORAL OR IMPLIED, INCLUDING, BUT NOT LIMITED TO ANY WARRANTY OF MERCHANTABILITY OR FITNESS FOR A PARTICULAR PURPOSE OR WARRANTY AGAINST LATENT DEFECTS.

LIMITATIONS OF LIABILITY

In the event of a warranty or other claim, the sole obligation of Perfect Fry will be limited to the repair or replacement, at the Company's discretion, of the appliance or the component part. This repair or replacement will be at the expense of Perfect Fry except as limited by this warranty statement. Any repair or replacement under this warranty does not constitute an extension in time to the original warranty. Parts covered under this warranty will be repaired or replaced, at the Company's discretion, with new or functionally operative parts. The liability of Perfect Fry on any claim of any kind, including claims based on warranty, express or implied contract, negligence, strict liability or any other legal theories will be limited to the repair or replacement of the appliance. This liability will not include, and the purchaser specifically renounces any right to recover special, incidental, consequential or other damages of any kind, including, but not limited to, injuries to persons, damage to property, loss of profits or anticipated loss of the use of this appliance.

If any provision of this warranty is unenforceable under the law of any jurisdiction, that provision only will be inapplicable there, and the remainder of the warranty will remain unaffected.

The maximum exclusion or limitation allowed by law will be substituted for the unenforceable provision.

HOW TO OBTAIN WARRANTY SERVICE

Direct your claim to the Perfect Fry Authorized Service and Parts Distributor, found at <http://perfectfry.com/servicemap.aspx>, closest to you giving complete model and serial number, voltage and description of the problem. Proof of the date of installation and/or the sales slip may also be required. If there are questions about this procedure, write the National Service Manager, Perfect Fry, 42 Allen Martin Drive, Essex Junction, VT 05452. USA

This warranty gives you certain specific legal rights; you may have other rights which vary from state to state.

ORIGINAL STANDARD EQUIPMENT LIMITED WARRANTY

INTERNATIONAL UNITS

Effective January 1, 2018, Serial Number E18AA000000

WARRANTY

1 Year Parts

During the first year after purchase, all parts of the fryer which prove to be defective in materials or workmanship will be replaced free of charge (parts only).

2 Years Electronics:

During the first 2 years after purchase, if the electronics module proves to be defective in materials or workmanship, it will be replaced free of charge (parts only).

TERMS OF WARRANTY

1. Perfect Fry Company LLC warrants this fryer to be free from defects in materials and workmanship and will repair or replace it at Perfect Fry Company LLC's option for a period of one year after purchase providing the purchaser follows the manufacturer's recommended procedures for operation and maintenance contained in this manual. Perfect Fry Company LLC shall not be liable for injury or damage to property other than this fryer.
2. The warranty applies to materials at the factory for one year (2 years electronics) from date of purchase. The warranty does not include materials and labor employed in cleaning the fryer. Any and all transportation and shipping charges and expenses are the responsibility of the Purchaser. The warranty card must be completed and registered with Perfect Fry Company LLC. within 30 days of purchase to validate the warranty. The warranty will cease to exist if maintenance has not been performed according to the manufacturer's instructions. This warranty does not cover damage arising from or caused by improper maintenance, directly or indirectly, transportation, accident, misuse, improper installation, fire, flood, or acts of God. Parts repaired or replaced under this warranty are warranted throughout the remainder of the original warranty period only. The warranty does not apply to parts and service supplied or obtained from other than Perfect Fry or its authorized distributors.
3. Other than the warranty expressed in clause 1) hereof, Perfect Fry Company LLC expressly disclaims all conditions and warranties, express or implied, including, without limitation, the implied warranties of merchantability and fitness for a particular purpose. Perfect Fry shall not be responsible for, nor does this warranty extend to, any consequential or incidental damages or expenses of any kind or nature, regardless of the cause thereof or any knowledge which Perfect Fry may have regarding the probability of the occurrence of such damages or expenses including, without limitation, injury to persons or property, loss of life, loss of use of the products, lost goodwill, loss of income, lost resale profits, work stoppage, impairment of other goods, breach of contract, negligence or such other actions as may be deemed or alleged to be the cause of a loss or damage.