



REFRIGERATION

SERVING THE FOOD INDUSTRY SINCE 1951

WHITE GELATO DISPLAY SHOWCASES

Item: 47571 / 47498 / 47572

Model: FR-CN-0007 / FR-CN-0010 / FR-CN-0013



10 Pans



13 Pans



7 Pans

**SERVE AND DISPLAY MOUTHWATERING
ICE CREAM, GELATO, AND SORBETS**

STANDARD FEATURES

- White Exterior
- Internal LED on top
- Digital controller
- Dual LED temp. displays inside and at back
- Sliding doors at back
- Front curved glass
- 4 casters, 2 with brakes
- Ventilating cooling system
- Automatic defrost



WARRANTY
PARTS AND LABOR



NEMA
5 - 15
125 VAC / 15 AMP
RECEPTACLE



Authorized Dealer

TECHNICAL SPECIFICATIONS

Item Number	47571	Adjustable Shelf	No
Model	FR-CN-0007	Temperature Controller	Digital Control
Color	White	Temperature Display	LED Display
Pan Quantity	7 x 5L Ice-Cream Pan	Defrost	Autodefrost With Heating Element
Ice-Cream Pan Dimensions	1 x Small Scoop Pan	Tray Heater (W)	No
Scoop Pan Dimensions	14.2" x 6.5" x 4.5" / 360 x 165 x 115mm	Type Of Light:	LED
Temperature Range	6.5" x 7.6" x 2.4" / 165 x 149 x 60mm	Lock	No
Power Supply	-12° to -22°C	Door Type	Sliding Doors At Back
Running Amps	110v / 60hz	Climate Class	4
Power Input (W)	11.8	Dimensions	41.3" x 33.5" x 51.2" / 1050 x 850 x 1300mm
Refrigerant Type	1300 W	Weight	306.4 lbs. / 139 kgs.
Cooling System:	R290 (140g)	Gross Dimensions	44.5" x 37.8" x 57.5" / 1130 x 960 x 1460mm
Space Requirement	Ventilated	Gross Weight	423.3 lbs. / 192 kgs.
	1.6 m ²	Certifications	cETLus, ETL Sanitations

PRODUCT DETAILS



Comes with 5L Ice Cream Pans

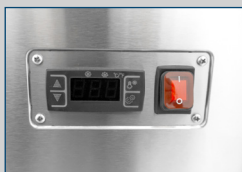

LED Display



Efficient sliding door at the back for easy access

ITEM: 47571
UOM: mm / inches

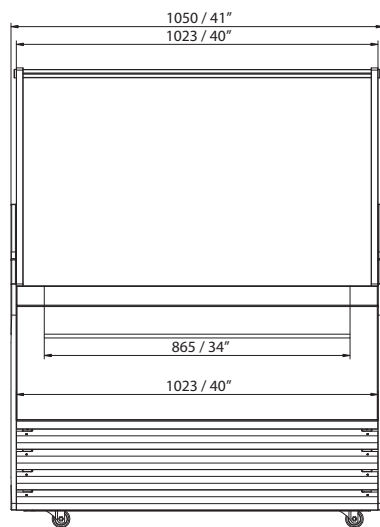

TECHNICAL DRAWINGS AND DIMENSIONS

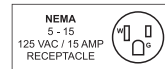
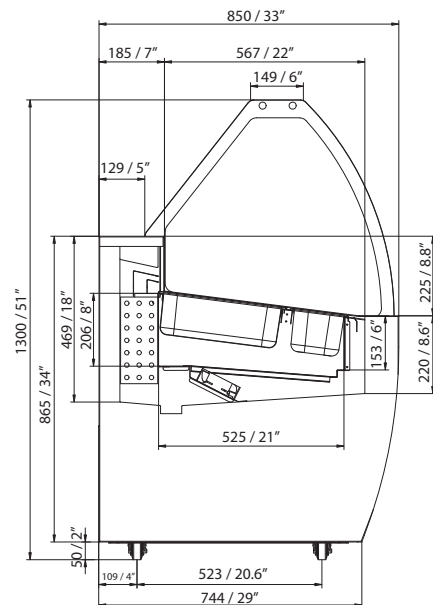

OMCAN INC.

Telephone: 1-800-465-0234

Fax: (905) 607-0234

Email: sales@omcan.com

Website: www.omcan.com



Follow us to keep up to date with the latest news and offers



TECHNICAL SPECIFICATIONS

Item Number	47498	Adjustable Shelf	No
Model	FR-CN-0010W	Temperature Controller	Digital Control
Color	White	Temperature Display	LED Display
Pan Quantity	10 x 5L Ice-Cream Pan	Defrost	Autodefrost With Heating Element
Ice-Cream Pan Dimensions	1 x Small Scoop Pan 14.2" x 6.5" x 4.5" / 360 x 165 x 115mm	Tray Heater (W)	No
Scoop Pan Dimensions	6.5" x 7.6" x 2.4" / 165 x 149 x 60mm	Type Of Light:	LED
Temperature Range	-12° to -22°C	Lock	No
Power Supply	110v / 60hz	Door Type	Sliding Doors At Back
Running Amps	13.6A	Climate Class	4
Power Input (W)	1500 W	Dimensions	55.4" x 33.5" x 51.2" 1408 x 850 x 1300mm
Refrigerant Type	R290 (160g)	Weight	372.6 lbs. / 169 kgs.
Cooling System:	Ventilated	Gross Dimensions	58.5" x 37.8" x 57.5" 1486 x 960 x 1460mm
Space Requirement	2.1 m ²	Gross Weight	504.9 lbs. / 229 kgs.
		Certifications	cETLus, ETL Sanitations

PRODUCT DETAILS



Comes with 5L Ice Cream Pans



LED Display



Efficient sliding door at the back for easy access

ITEM: 47498
UOM: mm / inches

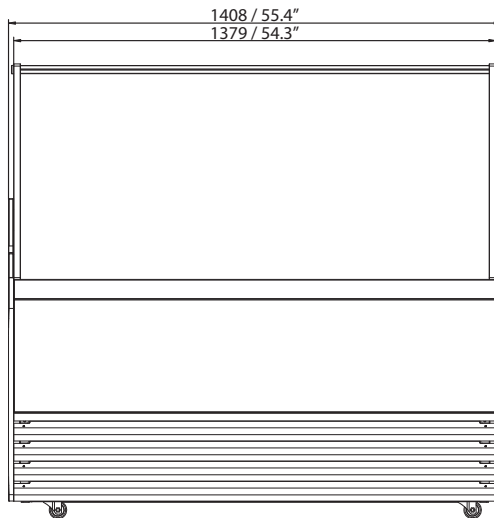

TECHNICAL DRAWINGS AND DIMENSIONS

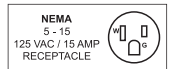
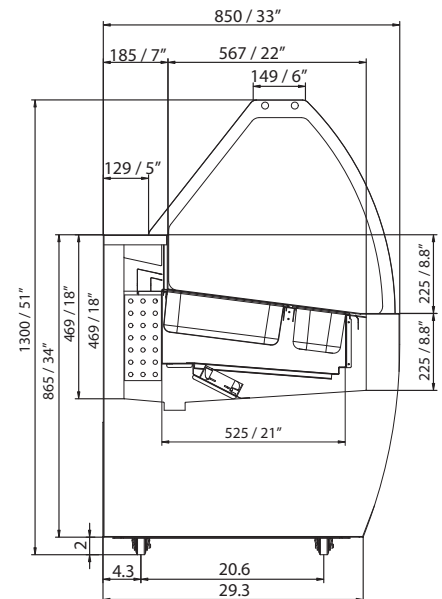

OMCAN INC.

Telephone: 1-800-465-0234

Fax: (905) 607-0234

Email: sales@omcan.com

Website: www.omcan.com



Follow us to keep up to date with the latest news and offers



TECHNICAL SPECIFICATIONS

Item Number	47572	Adjustable Shelf	No
Model	FR-CN-0013W	Temperature Controller	Digital Control
Color	White	Temperature Display	LED Display
Pan Quantity	13 x 5L Ice-Cream Pan	Defrost	Autodefrost With Heating Element
Ice-Cream Pan Dimensions	1 x Small Scoop Pan 14.2" x 6.5" x 4.5" / 360 x 165 x 115mm	Tray Heater (W)	No
Scoop Pan Dimensions	6.5" x 7.6" x 2.4" / 165 x 149 x 60mm	Type Of Light:	LED
Temperature Range	-12° to -22°C	Lock	No
Power Supply	110v / 60hz	Door Type	Sliding Doors At Back
Running Amps	13.6A	Climate Class	4
Power Input (W)	1500 W	Dimensions	69.4" x 33.5" x 51.2" 1764 x 850 x 1300mm
Refrigerant Type	R290 (170g)	Weight	434.3 lbs. / 197 kgs.
Cooling System:	Ventilated	Gross Dimensions	72.5" x 37.8" x 57.5" 1842 x 960 x 1460mm
Space Requirement	2.6 m ²	Gross Weight	582 lbs. / 264 kgs.
		Certifications	cETLus, ETL Sanitations

PRODUCT DETAILS



Comes with 5L Ice Cream Pans



LED Display



Efficient sliding door at the back for easy access

ITEM: 47572
UOM: mm / inches

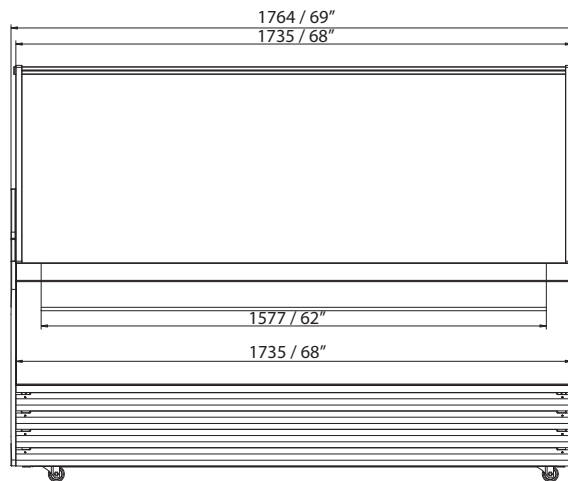

TECHNICAL DRAWINGS AND DIMENSIONS

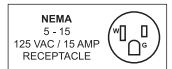
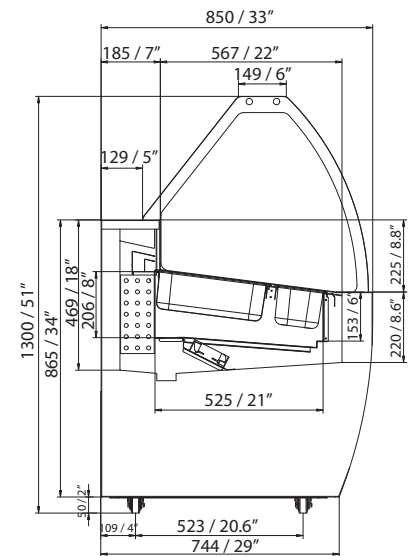

OMCAN INC.

Telephone: 1-800-465-0234

Fax: (905) 607-0234

Email: sales@omcan.com

Website: www.omcan.com



Follow us to keep up to date with the latest news and offers

