



FOOD EQUIPMENT

SERVING THE FOOD INDUSTRY SINCE 1951

WAFFLE MAKER WITH 1600 WATTS

ITEM: 39578 MODEL: CE-CN-0351



OFFER MOUTH-WATERING WAFFLES WITH OMCAN'S SINGLE WAFFLE MAKER

Designed with heavy-duty cast iron grid providing consistent results when making tasty and authentic waffles. This unit is equipped with a thermostat control that provides precise temperature and adjustments. Excellent for cafes, hotels, restaurants, and buffets.



LIMITED WARRANTY
PARTS AND LABOR



Authorized Dealer

FOOD EQUIPMENT

WAFFLE MAKER WITH 1600 WATTS



FEATURES

- Brussel style waffle maker
- On/ off switch with power indicator
- Drip tray to reduce waste
- Thermostatic temperature controller
- Temperature range from 60° - 300°C / 140°- 570°F

TECHNICAL SPECIFICATION

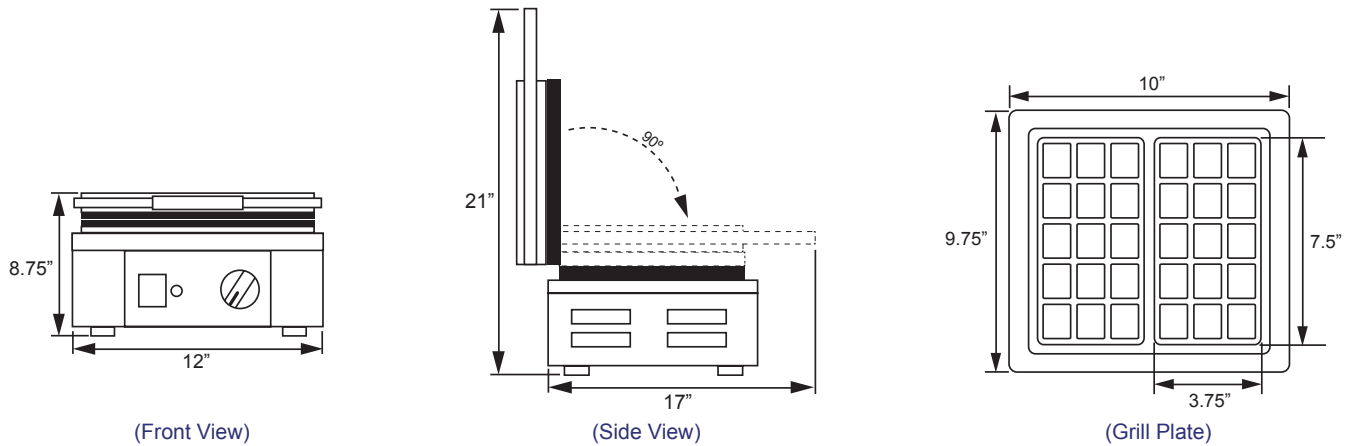

TECHNICAL SPECIFICATION	
ITEM NUMBER	39578
MODEL	CE-CN-0351
POWER	1600W
TEMPERATURE RANGE	60° - 300°C / 140° - 570°F
NUMBER OF WAFFLE	2
WAFFLE SIZE	7.5" x 3.75" / 190.5 x 89 mm
ELECTRICAL	120V/60Hz/1Ph
WEIGHT	37.5 lbs. / 17 kg.
PACKAGING WEIGHT	41.9 lbs. / 19 kg.
OVERALL DIMENSIONS (WDH)	12" x 17" x 8.75" x 8.75" (Close) or 21" (Open) / 305 x 432 x 222 mm (Close) or 533 mm (Open)
PACKAGING DIMENSIONS	18.8" x 15.7" x 13.5" / 478 x 400 x 345 mm

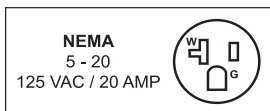

OMCAN INC.

Telephone: 1-800-465-0234
 Fax: (905) 607-0234
 Email: sales@omcan.com
 Website: www.omcan.com



Follow us to keep up to date with the latest news and offers

