



Automatic Citrus Juice Extractors

Models JE-ES-0015-F, 0015-T, 0015, 0015-S, 0028-F, 0028-T, 0045, 0045-B, 0028-BB

Items 39519, 39520, 39517, 39518, 39522, 39521, 40531, 40547, 41965

Instruction Manual



STOP
DO NOT RETURN
THIS PRODUCT TO THE STORE

For questions or assistance with this product call OMCAN Toll Free: 1 800 465 0234
Customer Service
or
visit the Support section of www.omcan.com

Revised - 01/19/2023



Toll Free: 1-800-465-0234
Fax: 905-607-0234
Email: service@omcan.com
www.omcan.com

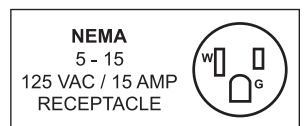

Table of Contents

Model JE-ES-0015-F / Model JE-ES-0015-T / Model JE-ES-0015
Model JE-ES-0015-S / Model JE-ES-0028-F / Model JE-ES-0028-T
Model JE-ES-0045 / Model JE-ES-0045-B / Model JE-ES-0028-BB

Section	Page
General Information -----	3 - 4
Safety and Warranty -----	4 - 6
Technical Specifications -----	6 - 8
Installation -----	8 - 9
Operation -----	9 - 10
Maintenance -----	11 - 13
Troubleshooting -----	13 - 14
Instructions Français -----	14 - 23
Instrucciones en Español -----	23 - 33
Parts Breakdown -----	34 - 46
Electrical Schematics -----	47 - 48
Notes -----	49 - 50
Warranty Registration -----	51



General Information

Omcan Manufacturing and Distributing Company Inc., Food Machinery of America, Inc. dba Omcan and Omcan Inc. are not responsible for any harm or injury caused due to any person's improper or negligent use of this equipment. The product shall only be operated by someone over the age of 18, of sound mind, and not under the influence of any drugs or alcohol, who has been trained in the correct operation of this machine, and is wearing authorized, proper safety clothing. Any modification to the machine voids any warranty, and may cause harm to individuals using the machine or in the vicinity of the machine while in operation.

CHECK PACKAGE UPON ARRIVAL

Upon receipt of an Omcan shipment please inspect for external damage. If no damage is evident on the external packaging, open carton to ensure all ordered items are within the box, and there is no concealed damage to the machine. If the package has suffered rough handling, bumps or damage (visible or concealed), please note it on the bill of lading before accepting the delivery and contact Omcan within 24 hours, so we may initiate a claim with the carrier. A detailed report on the extent of the damage caused to the machine must be filled out within three days, from the delivery date shown in the shipping documents. Omcan has no recourse for damaged products that were shipped collect or third party.

Before operating any equipment, always read and familiarize yourself with all operation and safety instructions.

Omcan would like to thank you for purchasing this machine. It's of the utmost importance to save these instructions for future reference. Also save the original box and packaging for shipping the equipment if servicing or returning of the machine is required.

Omcan Fabrication et distribution Compañie Limité et Food Machinery d'Amérique, dba Omcan et Omcan Inc. ne sont pas responsables de tout dommage ou blessure causé du fait que toute personne ait utilisé cet équipement de façon irrégulière. Le produit ne doit être exploité que par quelqu'un de plus de 18 ans, saine d'esprit, et pas sous l'influence d'une drogue ou d'alcool, qui a été formé pour utiliser cette machine correctement, et est vêtu de vêtements de sécurité approprié. Toute modification de la machine annule toute garantie, et peut causer un préjudice à des personnes utilisant la machine ou des personnes à proximité de la machine pendant son fonctionnement.

VÉRIFIEZ LE COLIS DÈS RÉCEPTION

Dès réception d'une expédition d'Omcan veuillez inspecter pour dommages externes. Si aucun dommage n'est visible sur l'emballage externe, ouvrez le carton afin de s'assurer que tous les éléments commandés sont dans la boîte, et il n'y a aucun dommage dissimulé à la machine. Si le colis n'a subi aucune mauvaises manipulations, de bosses ou de dommages (visible ou cachée), notez-le sur le bond de livraison avant d'accepter la livraison et contactez Omcan dans les 24 heures qui suivent, pour que nous puissions engager une réclamation auprès du transporteur. Un rapport détaillé sur l'étendue des dommages causés à la machine doit être rempli dans un délai de trois jours, à compter de la date de livraison indiquée dans les documents d'expédition. Omcan n'a aucun droit de recours pour les produits endommagés qui ont été expédiés ou cueilli par un tiers transporteur.

General Information

Avant d'utiliser n'importe quel équipement, toujours lire et vous familiariser avec toutes les opérations et les consignes de sécurité.

Omcan voudrais vous remercier d'avoir choisi cette machine. Il est primordial de conserver ces instructions pour une référence ultérieure. Également conservez la boîte originale et l'emballage pour l'expédition de l'équipement si l'entretien ou le retour de la machine est nécessaire.

Omcan Empresa De Fabricacion Y Distribucion Inc. Y Maquinaria De Alimentos De America, Inc. dba Omcan y Omcan Inc. no son responsables de ningun daño o perjuicio causado por cualquier persona inadecuada o el uso descuidado de este equipo. El producto solo podra ser operado por una persona mayor de 18 años, en su sano juicio y no bajo alguna influencia de droga o alcohol, y que este ha sido entrenado en el correcto funcionamiento de esta máquina, y ésta usando ropa apropiada y autorizada. Cualquier modificación a la máquina anula la garantía y puede causar daños a las personas usando la máquina mientras esta en el funcionamiento.

REVISE EL PAQUETE A SU LLEGADA

Tras la recepcion de un envio Omcan favor inspeccionar daños externos. Si no hay daños evidentes en el empaque exterior, Habra el carton para asegurarse que todos los articulos solicitados estén dentro de la caja y no encuentre daños ocultos en la máquina. Si el paquete ha sufrido un manejo de poco cuidado, golpes o daños (visible o oculto) por favor anote en la factura antes de aceptar la entrega y contacte Omcan dentro de las 24 horas, de modo que podamos iniciar una reclamación con la compañía. Un informe detallado sobre los daños causados a la máquina debe ser llenado en el plazo de tres días, desde la fecha de entrega que se muestra en los documentos de envío. Omcan no tiene ningun recurso por productos dañados que se enviaron a recoger por terceros.

Antes de utilizar cualquier equipo, siempre lea y familiarizarse con todas las instrucciones de funcionamiento y seguridad.

Omcan le gustaría darle las gracias por la compra de esta máquina. Es de la mayor importancia para salvar estas instrucciones para futuras consultas. Además, guarda la caja original y el embalaje para el envío del equipo si servicio técnico o devolución de la máquina que se requiere.

Safety and Warranty

- It is the responsibility of the user to read the enclosed warnings prior to using this machine.
- After removing the packaging, check that equipment is not damaged. If in doubt, do not use it and contact Omcan.
- The packaging materials (plastic bags, foam, cork, etc.) should not be left within reach of children, as they are a potential danger.
- Before assembling the machine, please, make sure there are no pieces left in the packaging.
- The machine needs to have some ventilation around it in order to perform properly.

Safety and Warranty

- For models on a stand, remember to set the brakes on the front wheels in order to prevent unwanted moving.
- Before use, clean all the juicing area, SEE CLEANING INSTRUCTIONS in Maintenance.
- Never start the machine without making sure that all components are in their correct place, especially the front cover otherwise the security detector will not allow the machine to run.
- When using the machine, do not touch or access to the moving parts neither by hands nor with any utensils.
- Machine should never be operated by minor or inexperienced staff without supervision.
- Check that the voltage of your outlet is according to voltage stated in technical label on the side of your machine.
- Do not use an extension cord. If you decide to do it, it is on your own responsibility, use only extension that is in good condition and suitable for the power of the machine. The extension cord should be placed so that no one can pull it or stumble.
- Do not allow the cord to come into contact with hot surfaces.
- To protect against risk of electrical shock and personal injury, do not immerse cord, plug or appliance in water or any other liquid.
- This product is designed for indoor use, do not expose this appliance to rain or moisture and do not use it outdoors or with wet hands.
- Always place the machine on a dry, stable and leveled surface.
- To disconnect from the electrical outlet pull the plug gently. Never pull from the cord.
- The use of accessories not recommended by the manufacturer may cause fire, electric shock or injury, always use original spare parts.

THE PROPER SIZE OF ORANGE IN ORDER TO OBTAIN BEST RESULTS IS 60-80MM (2.4 - 3.1 INCH) DIAMETER.

- It is recommended to wash fruit before juice extraction.
- Do not use the machine out of the temperature range: (from -20° to 40°C / -4° to 104°F).
- The manufacturer declines any responsibility for damages resulting from improper, careless or negligent use of equipment, as well as from use by unauthorized persons.

Due to high manufacturing standards and strict quality controls, we guarantee the perfect performance of our machines.

THIS WARRANTY DOES NOT COVER: The breakage or weakness of any part or component as a consequence of improper or inadequate installation, misuse or neglect. Furthermore, we will not be held responsible for damage caused by normal wear and tear, repair or modification to any part of the machine undertaken by any unauthorized person. To fulfil the terms of the warranty, all repairs must be performed by our technical department or the official Omcan distributor.

Any falsification of warranty documentation, or the loss or damage to the machine's identification plate, will void manufacturer's warranty.

RESIDENTIAL USERS: Vendor assumes no liability for parts or labor coverage for component failure or other damages resulting from installation in non-commercial or residential applications. The right

Safety and Warranty

is reserved to deny shipment for residential usage; if this occurs, you will be notified as soon as possible.

5 YEAR PARTS AND 1 YEAR LABOUR WARRANTY

Within the warranty period, contact Omcan Inc. at 1-800-465-0234 to schedule an Omcan authorized service technician to repair the equipment locally.

Unauthorized maintenance will void the warranty. Warranty covers electrical and part failures, not improper use.

Please see <https://omcan.com/disclaimer> for complete info.

WARNING:

The packaging components are classified as normal solid urban waste and can therefore be disposed of without difficulty.

In any case, for suitable recycling, we suggest disposing of the products separately (differentiated waste) according to the current norms.

DO NOT DISCARD ANY PACKAGING MATERIALS IN THE ENVIRONMENT!

Technical Specifications

MINIMAX

Model	JE-ES-0015	JE-ES-0015-S
HP	0.75 HP	
Fruit Diameter	2.36" - 3.15" / 60 - 80mm	
Feeder Capacity	6 Oranges	
Peel Bucket	19.8 lbs. / 9 kgs.	
Production	15 oranges per minute	
Electrical	110-120V / 60Hz / 1	
Current	9 / 8.6 A	
Dimensions	17.7" x 19.3" x 33" / 450 x 490 x 838mm	
Weight	113.1 lbs. / 51.3 kgs.	
Item Number	39517	39518



Technical Specifications

MINIMATIC

Model	JE-ES-0015-F	JE-ES-0015-T
HP	0.75 HP	
Fruit Diameter	2.36" - 3.15" / 60 - 80mm	
Feeder Capacity	13.2 lbs. / 6 kgs.	
Peel Bucket	19.8 lbs. / 9 kgs.	
Production	15 oranges per minute	
Electrical	110-120V / 60Hz / 1	
Current	9 / 8.6 A	
Dimensions	17.7" x 19.3" x 36.6" / 450 x 490 x 930mm	
Weight	119.9 lbs. / 54.4 kgs.	
Item Number	39519	39520

TOP

Model	JE-ES-0028-F	JE-ES-0028-T
HP	0.75 HP	
Fruit Diameter	2.36" - 3.15" / 60 - 80mm	
Feeder Capacity	39 lbs. / 18 kgs.	
Peel Bucket	44 lbs. / 20 kgs.	
Production	28 oranges per minute	
Electrical	110-120V / 60Hz / 1	
Current	9 / 8.6 A	
Dimensions	19.7" x 24.4" x 39" / 500 x 620 x 991mm	
Weight	104.7 lbs. / 47.5 kgs.	
Item Number	39522	39521

FAST TOP

Model	JE-ES-0045	JE-ES-0045-B
HP	0.75 HP	
Fruit Diameter	2.36" - 3.15" / 60 - 80mm	
Feeder Capacity	39 lbs. / 18 kgs.	
Peel Bucket	44 lbs. / 20 kgs.	
Production	45 oranges per minute	
Electrical	110-120V / 60Hz / 1	
Current	9 / 8.6 A	
Dimensions	19.7" x 24.4" x 39" / 500 x 620 x 991mm	
Weight	104.7 lbs. / 47.5 kgs. (188 lbs. / 83.5 kgs. with stand)	
Item Number	40531	40547

Technical Specifications

BIG BASIC

Model	JE-ES-0028-BB
HP	0.75 HP
Fruit Diameter	3" - 3.8" / 76 - 97mm
Feeder Capacity	6 Fruits
Peel Bucket	44 lbs. / 20 kgs.
Production	28 fruits per minute
Electrical	110-120V / 60Hz / 1
Current	4.1 / 3.7 A - 9 / 8.6 A
Dimensions	17" x 28.7" x 33.8" / 432 x 729 x 859mm
Weight	93.9 lbs. / 42.6 kgs.
Item Number	41965

Installation

Proceed to assemble all the pieces that for transportation reasons come disassembled in their proper location.

SET UP OF THE MACHINE

Minimax: Unscrew the thumbscrew and place the feeder tube. Place the peel bucket and the juice tray.

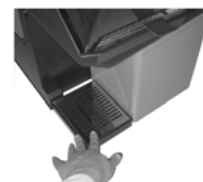

Minimatic: Unscrew the thumbscrew and the screw of the head feeder, place the feeder tube. Place the peel bucket and the juice tray.



Top/Fast Top: Place the basket, remove the filter and the cover screen. Fit the feeding tube. Replace the cover screen and the filter. Finally place the peel buckets and the juice tray.



Installation



Plug the machine into a normal electrical socket with ground protection.

Operation

DIGITAL USER-FRIENDLY DISPLAY SCREEN

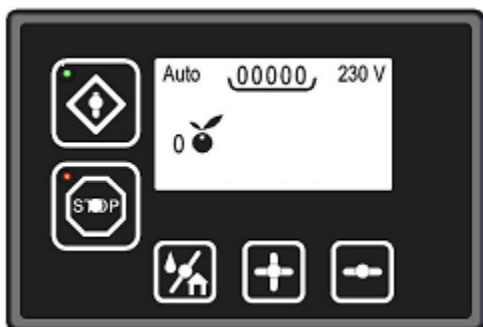

- Number of oranges squeezed.
- Incoming voltage.
- Selection of mode of operation:
 - By the self tap (when available).
 - By the number of oranges selected.
- Self cleaning function (when available).
- Reverse rotation.
- Detection of full peel buckets.
- Detection of failures.
- Easy dismantling mode: Horizontal stop function for cleaning.
- Switch off Timer & Squeezing limit

Proceed to introduce oranges through the feeding tube, or the feeding basket (depending on the model).

TO BEGIN THE SQUEEZING PROCESS

Turn on the switch, which is situated at the upper right side of the machine (position I).

Machines with SELF SERVICE TAP:

Turn the self switch to the position AUT, press the tap (As indicated on the sticker on the cover screen).

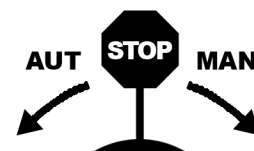

Operation

Machines with PROGRAMMER:

Once the switch has been switched on, push one of the red buttons situated on the front of the machines. The buttons refer to 1, 2, or 3 oranges, while the button on the right refers to continuing squeezing.

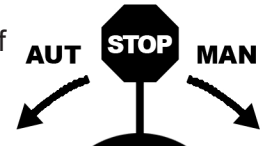

Machines with JUICE LEVEL DETECTOR:

Once the switch of the machine is turned on, turn the detector switch to the position AUT. In manual mode the switch can be used.



Machines with AUTOMATIC SHOWER:

Once the water tube has been connected to the connection at the back of the machine, push the green button. The machine has to work in able to connect the shower.

TO STOP THE SQUEEZING PROCESS

Stop the machine by pressing the 0 red button at the on/off switch.

Machines with SELF SERVICE TAP:

Close the tap and turn the red light switch off (STOP) as indicated on the sticker on the cover screen.

Machines with PROGRAMMER:

The first 3 options stop automatically. To stop the continuing mode, push again this button and put the switch (Pos.0).

Machines with JUICE LEVEL DETECTOR:

In "AUT", the machine stops automatically, once the dispenser is full. If the machine operates in "MAN", disconnect the on switch.

Machines with AUTOMATIC SHOWER:

Push the SHOWER button and close the water connection.

AUT = Automatic

MAN = Manual

CLEANING AND MAINTENANCE

Once the juice extraction has been finished, stop the machine according to the model.

Leave the rods of the squeezer double drum in a vertical position.

Make sure that the squeezer male parts are horizontal.

Unplug the machine from the mains socket.

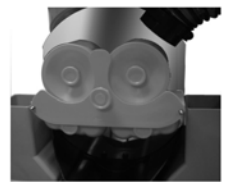

REMOVE THE JUICE FILTER

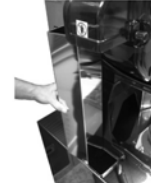

Empty the peel bucket.

Remove the front cover, moving it slowly upwards and towards.



Remove the front cover, by unscrewing the two lateral screws.



MINIMAX – MINIMATIC

Remove the positioner, pushing it upwards.
Remove the knife, by unscrewing the knife screw (Be careful. The knife is sharp). Remove the squeezer male part, by unscrewing the screw.

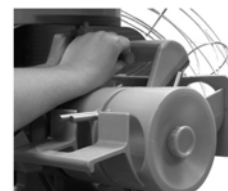
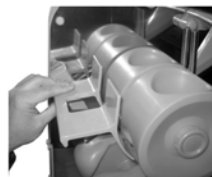

Remove the squeezer drum by unscrewing the screw. Remove the second squeezer male part.



Maintenance

Remove the ejector.

For the models with head feeder: Take of the turning feeder plate, by unscrewing the screw.



TOP/FAST TOP

Unscrew the five principal screws of the squeezing system parts.



Remove the two squeezing drums, the two male parts and knife piece pulling it outwards. Be careful with this part, because of its cutting edge.

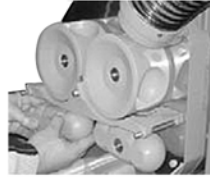

For the models with the upper feeder component, twist softly the upper metal basket all the way towards the left and then gently pull up. Remove the turning dish by unscrewing the screw towards the right.



Thoroughly clean all parts, and block of the machine with cold water and detergent.

Do not use abrasive nor corrosive products, since they could harm the compound of the elements of the machine. Do not clean the machine with water under pressure.

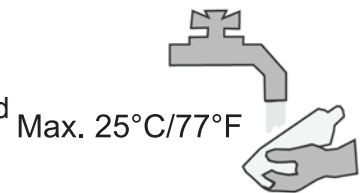

Dry the components of the system and the block of the machine.

Assemble all the parts in reverse order. No tools are required to assemble or disassemble the machine. All parts should fit with ease and without undue force.

For machines with self service tap, IMPORTANT: In order to ensure the perfect hygiene of your orange squeezer, it is necessary to clean the tap periodically. Follow the instructions according to the diagram.

Maintenance

Follow the depicted instructions.

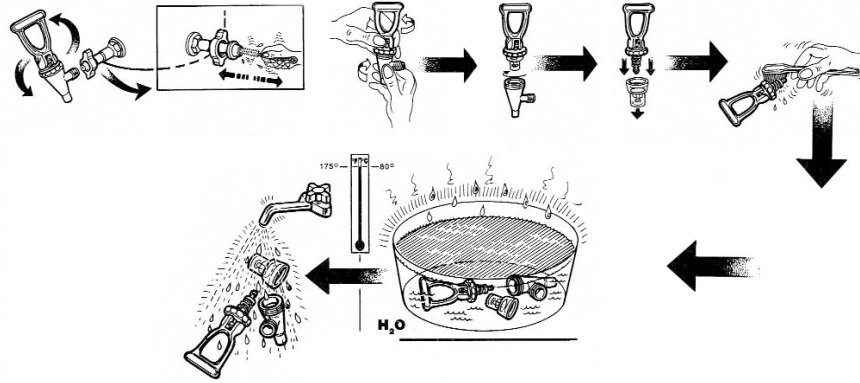

For machines with AUTOMATIC SHOWER: This system does not replace the daily cleaning of the machine. It permits a quick cleaning during the day, of the area the oranges are squeezed.

You must connect a hose with the 3/8" thread end (international common standard thread) to the water connection of the machine and the other end with the thread that has the water outlet.

You can regulate the flow of water by opening and closing the tap. Up is closed and down is open.

Other than daily cleaning, Omcan machines require no other routine maintenance.

Troubleshooting

FAILURE	POSSIBLE CAUSE	SOLUTION
The machine does not operate.	Machine unplugged.	Plug it to socket.
	No power.	Check the plug and socket.
	Transparent cover misplaced.	Make sure it is well placed.
	Defective safe detectors.	Call Customer service.
	Defective ON / OFF button.	Call Customer service.
	Defective electric circuit.	Call Customer service.
The machine is blocked while squeezing is in progress.	Insufficient voltage.	Check that the voltage is according to indicated on the identification label.
	Wrong fruit size.	Check the size of the fruit is as shown in this manual.
The Positioner is broken or bent.	Misplaced drum or positioned.	Make sure the pieces are well placed.

Troubleshooting

The tap is blocked.	Juice has seeds or excessive pulp.	Disassemble and clean the tap as described in the manual.
The machine stops every few minutes.	Insufficient ventilation.	Check that ventilation gratings are not covered.
	Electrical overload.	Call Customer service.

Instructions Français

SECURITE ET GARANTIE

- Il est de la responsabilité de l'utilisateur de lire les avertissements ci-jointe avant l'utilisation de cette machine
- Après retrait de l'emballage, vérifier que l'équipement n'est pas endommagé. En cas de doute, n'utilisez pas l'appareil et contactez Omcan.
- Les matériaux d'emballage (sacs en plastique, mousse, liège, etc.) ne devrait pas être laissé à la portée des enfants, car ils sont un danger potentiel.
- Avant le remontage de la machine, s'il vous plaît, assurez-vous qu'il n'y a pas de morceaux gauche dans l'emballage.
- La machine doit avoir une certaine ventilation autour d'elle afin d'effectuer correctement.
- Pour les modèles sur un stand, n'oubliez pas de régler les freins sur les roues avant afin d'éviter tout déplacement.
- Avant toute utilisation, nettoyer tous les jus zone, voir INSTRUCTIONS DE NETTOYAGE en maintenance.
- Ne jamais démarrer la machine sans s'assurer que tous les composants sont à leur place, en particulier le capot avant sinon le détecteur de sécurité sera pas permettre à la machine de fonctionner.
- Lors de l'utilisation de la machine, ne pas toucher ni l'accès aux pièces en mouvement ni par les mains ni avec ustensiles de cuisine.
- La machine ne doit jamais être utilisé par mineur ou personnel inexpérimenté sans surveillance.
- Vérifier que la tension de votre prise est en fonction de la tension indiqué dans étiquette technique sur le côté de votre machine.
- Ne pas utiliser de rallonge. Si vous décidez de le faire, il est de votre propre responsabilité, utilisez seulement extension qui est en bon état et adapté à la puissance de la machine. La rallonge doit être placé de manière à ce que personne ne peut tirer ou trébucher.
- Ne pas laisser le cordon entrer en contact avec des surfaces chaudes.
- Pour vous protéger contre le risque de choc électrique et de blessure, ne pas immerger le cordon, fiche ou l'appareil dans l'eau ou dans tout autre liquide.
- Ce produit est conçu pour une utilisation intérieure, n'exposez pas cet appareil à la pluie ou à l'humidité et ne l'utilisez pas à l'extérieur ou avec les mains mouillées.
- Toujours placer la machine sur un sec et stable et surface nivelée
- Pour le débrancher de la prise électrique tirer le bouchon avec précaution. Ne jamais tirer sur le cordon.
- L'utilisation d'accessoires non recommandés par le fabricant risque de causer un incendie, un choc électrique ou de blessure, toujours utiliser des pièces de rechange d'origine.

Instructions Français

LA TAILLE ADÉQUATE D'ORANGE AFIN D'OBTENIR DE MEILLEURS RÉSULTATS EST 60-80MM (2,4 - 3,1 POUCES) DE DIAMÈTRE.

- Il est recommandé de laver les fruits avant l'extraction de jus.
- N'utilisez pas la machine hors de la plage de température: (à partir de -20° à 40° C / -4° à 104° F).
- Le fabricant décline toute responsabilité pour les dommages résultant d'un mauvais, imprudente ou négligente utilisation de l'équipement, ainsi que de l'utilisation par l'una.

En raison de hautes normes de fabrication et contrôles de qualité stricts, nous garantir la performance parfaite de nos machines.

CETTE GARANTIE NE COUVRE PAS: la rupture ou la faiblesse de toute pièce ou tout composant en conséquence de installation incorrecte ou inadéquate, d'une mauvaise utilisation ou de négligence. En outre, nous ne pourrons pas être tenu responsable pour les dommages causés par l'usure normale Et de découpe, de la réparation ou de la modification de toute partie de la machine entrepris par toute personne non autorisée. Pour remplir les conditions de la garantie, toutes les réparations doivent être effectuées par notre département technique ou le fonctionnaire Omcan distributeur.

Toute falsification de documentation de garantie, ou la perte ou l'endommagement de la machine de plaque d'identification, annulera la garantie du fabricant.

UTILISATEURS RÉSIDENTIELS: Le fournisseur n'assume aucune responsabilité pour les pièces ou la main-d'œuvre en cas de défaillance des composants ou d'autres dommages résultant de l'installation dans des applications non commerciales ou résidentielles. Le droit est réservé de refuser l'expédition pour un usage résidentiel; si cela se produit, vous en serez informé dans les plus brefs délais.

GARANTIE DE 5 ANS SUR LES PIÈCES ET 1 AN SUR LA MAIN-D'ŒUVRE

Dans la période de garantie, contacter Omcan Inc. au 1-800-465-0234 pour planifier une Omcan technicien autorisé à réparer l'équipement localement.

Entretien non autorisée annulera la garantie. La garantie couvre les pannes électriques et de pièces, pas une mauvaise utilisation.

S'il vous plaît voir <https://omcan.com/disclaimer> pour info complète.

AVERTISSEMENT:

Les composants d'emballage sont classés comme normaux déchets et résidus solides urbains et peuvent donc être éliminés.

En tout cas, pour recyclage adéquats, nous suggérons mise au rebut des produits séparément (différencié des déchets) selon les normes actuelles.

NE JETEZ PAS LES MATÉRIAUX D'EMBALLAGE DANS L'ENVIRONNEMENT!

Instructions Français

DETAILS TECHNIQUES

MINIMAX

Modèle	JE-ES-0015	JE-ES-0015-S
HP	0.75 HP	
Diamètre des fruits	2.36" - 3.15" / 60 - 80mm	
Capacité du chargeur	6 Oranges	
Seau à peler	19.8 lbs. / 9 kgs.	
Production	15 oranges per minute	
Électrique	110-120V / 60Hz / 1	
Courant	9 / 8.6 A	
Dimensions	17.7" x 19.3" x 33" / 450 x 490 x 838mm	
Poids	113.1 lbs. / 51.3 kgs.	
Numéro d'article	39517	39518

MINIMATIC

Modèle	JE-ES-0015-F	JE-ES-0015-T
HP	0.75 HP	
Diamètre des fruits	2.36" - 3.15" / 60 - 80mm	
Capacité du chargeur	13.2 lbs. / 6 kgs.	
Seau à peler	19.8 lbs. / 9 kgs.	
Production	15 oranges per minute	
Électrique	110-120V / 60Hz / 1	
Courant	9 / 8.6 A	
Dimensions	17.7" x 19.3" x 36.6" / 450 x 490 x 930mm	
Poids	119.9 lbs. / 54.4 kgs.	
Numéro d'article	39519	39520

Instructions Français

TOP

Modèle	JE-ES-0028-F	JE-ES-0028-T
HP	0.75 HP	
Diamètre des fruits	2.36" - 3.15" / 60 - 80mm	
Capacité du chargeur	39 lbs. / 18 kgs.	
Seau à peler	44 lbs. / 20 kgs.	
Production	28 oranges per minute	
Électrique	110-120V / 60Hz / 1	
Courant	9 / 8.6 A	
Dimensions	19.7" x 24.4" x 39" / 500 x 620 x 991mm	
Poids	104.7 lbs. / 47.5 kgs.	
Numéro d'article	39522	39521

FAST TOP

Modèle	JE-ES-0045	JE-ES-0045-B
HP	0.75 HP	
Diamètre des fruits	2.36" - 3.15" / 60 - 80mm	
Capacité du chargeur	39 lbs. / 18 kgs.	
Seau à peler	44 lbs. / 20 kgs.	
Production	45 oranges per minute	
Électrique	110-120V / 60Hz / 1	
Courant	9 / 8.6 A	
Dimensions	19.7" x 24.4" x 39" / 500 x 620 x 991mm	
Poids	104.7 lbs. / 47.5 kgs. (188 lbs. / 83.5 kgs. with stand)	
Numéro d'article	40531	40547

BIG BASIC

Modèle	JE-ES-0028-BB
HP	0.75 HP
Diamètre des fruits	3" - 3.8" / 76 - 97mm
Capacité du chargeur	6 Fruits
Seau à peler	44 lbs. / 20 kgs.
Production	28 fruits per minute
Électrique	110-120V / 60Hz / 1
Courant	4.1 / 3.7 A - 9 / 8.6 A
Dimensions	17" x 28.7" x 33.8" / 432 x 729 x 859mm
Poids	93.9 lbs. / 42.6 kgs.
Numéro d'article	41965

Instructions Français

INSTALLATION

Passez à assembler toutes les pièces que le transport pour raisons viennent démonté dans leur emplacement correct.

CONFIGURATION DE LA MACHINE

Minimax: dévisser la vis moletée et placer le tuyau d'alimentation. Placer le godet peel et le jus bac.



Minimatic: dévisser la vis à ailettes et la vis de la tête d'alimentation, placez le tube d'alimentation. Placer le godet peel et le jus bac.

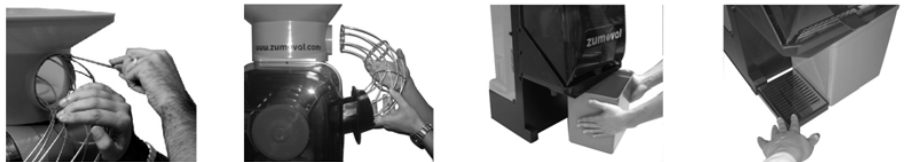

Top/Fast Top: Placez le panier, déposer le filtre et le couvercle écran. Mettre en place le tube d'alimentation. Remplacer le tamis du couvercle et le filtre. Enfin placer le peel les godets et les jus bac.

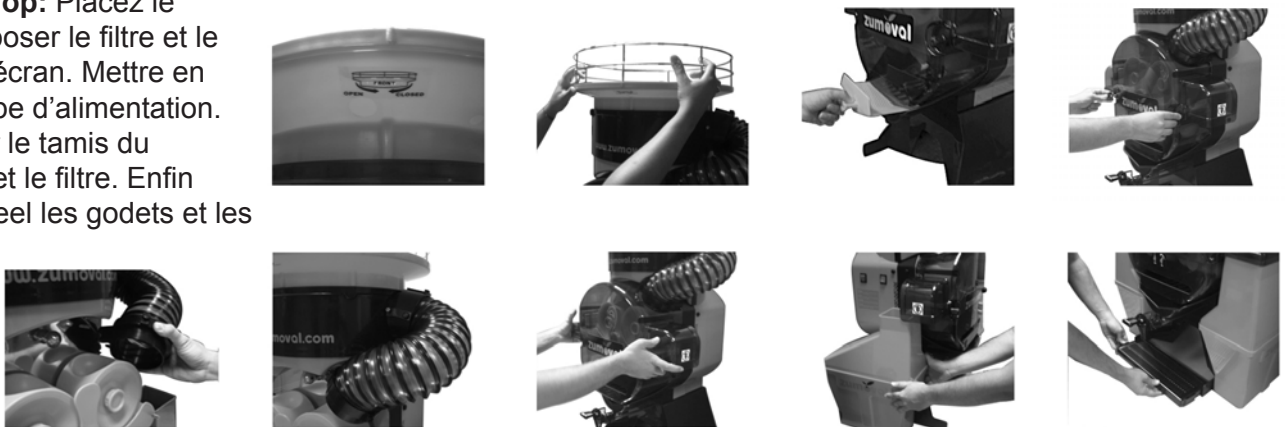

Branchez l'appareil sur une prise électrique normale avec protection du sol.

Instructions Français

OPÉRATION

ÉCRAN NUMÉRIQUE FACILE À UTILISER

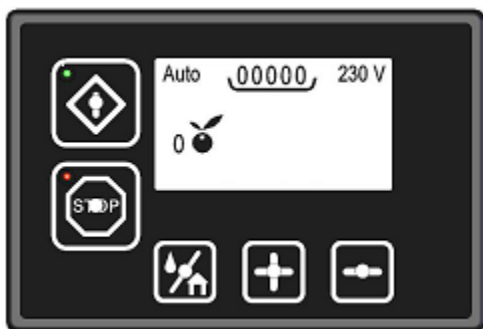

- Quantité d'oranges pressées.
- Tension entrante.
- Sélection de la mode d'opération.
 - En utilisant le robinet automatique (quand il est disponible).
 - Par la nombre d'oranges sélectionnés.
- Fonction autonettoyante.
- Rotation inverse.
- Détection de seaux pleins d'écorces.
- Détection de pannes.
- Démontage facile: fonction arrêt horizontale pour nettoyage.
- Minuterie et limite de pressage.

Continuer à introduire des oranges à travers le tube d'alimentation, ou le panier d'alimentation (selon le modèle).

POUR COMMENCER LE PROCESSUS PINÇANT

Mettez le commutateur, qui est situé en haut à droite de la machine (position I).

LES MACHINES AVEC SELF SERVICE APPUYEZ SUR:

Désactiver l'auto-commutateur à la position AUT, appuyez sur le robinet (comme indiqué sur l'autocollant apposé sur le couvercle écran).

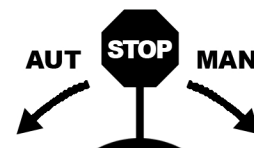

MACHINES AVEC PROGRAMMATEUR:

Une fois que le commutateur a été activé, appuyer sur l'un des boutons rouges situé sur l'avant de la machine. Les boutons se reporter à 1, 2 ou 3 oranges, tandis que le bouton à droite se réfère à la poursuite pinçant.

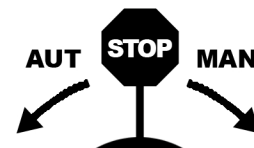

LES MACHINES AVEC NIVEAU DE JUS DÉTECTEUR:

Une fois l'interrupteur de la machine est sous tension, mettez l'interrupteur du détecteur à la position AUT. En mode manuel, le commutateur peut être utilisé.

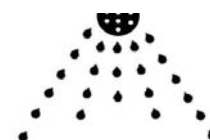

Instructions Français

LES MACHINES AVEC DOUCHE AUTOMATIQUE:

Une fois que le tube à eau a été connecté à la connexion à l'arrière de la machine, appuyez sur le bouton vert. La machine a à travailler en mesure de connecter la douche.

POUR ARRÊTER LE PROCESSUS PINÇANT

Arrêter la machine en appuyant sur le 0 bouton rouge à l'aide de l'interrupteur marche/arrêt.

LES MACHINES AVEC SELF SERVICE APPUYEZ SUR:

Fermez le robinet et tournez le rouge contacteur d'éclairage en position d'arrêt (STOP) comme indiqué sur l'autocollant apposé sur le couvercle écran.

MACHINES AVEC PROGRAMMATEUR:

Les 3 premières options s'arrête automatiquement. Pour arrêter le mode continu, poussez à nouveau ce bouton et mettre le commutateur (Pos.0).

LES MACHINES AVEC NIVEAU DE JUS DÉTECTEUR:

Dans «AUT», la machine s'arrête automatiquement, une fois que le distributeur est plein. Si la machine fonctionne en «MAN», débrancher le commutateur.

LES MACHINES AVEC DOUCHE AUTOMATIQUE:

Poussez le bouton douche et fermer la connexion d'eau.

AUT = Automatique

MAN = Manuele

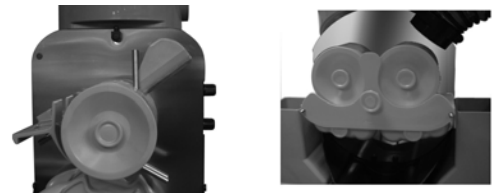

ENTRETIENS

NETTOYAGE ET ENTRETIEN

Une fois le jus d'extraction a été terminé, arrêter la machine en fonction du modèle.

Laisser les tiges du Squeezer brevetées double tambour en position verticale.

Assurez-vous que le Squeezer brevetées pièces mâle sont horizontales.

Branchez la machine à partir de la prise secteur.



Instructions Français

DÉPOSER LE FILTRE DE JUS

Vider le godet de peel.

Retirez le couvercle avant, déplaçant lentement vers le haut et vers.

Retirer le capot avant, en dévissant les deux vis latérales.



MINIMAX – MINIMATIC

Retirer le positionneur, poussant vers le haut.
Retirez le couteau, en dévissant la vis de couteau
(Soyez prudent. Le couteau est tranchant).
Retirer la partie presse-mâle, en dévissant la vis.

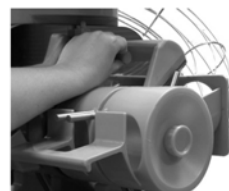
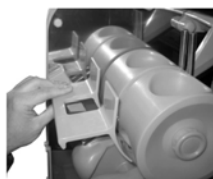

Retirer le tambour de pressage en dévissant la vis.
Retirer la deuxième partie presse-mâle.

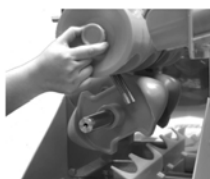

Retirer l'éjecteur.
Pour les modèles avec tête alimentation:
Prenez de la plaque d'alimentation tournant, en dévissant la vis.



TOP/FAST TOP

Dévissez les cinq principaux vis des pièces du système de compression.



Retirez les deux tambours de pressage, les deux parties mâles et knifepiece tirant vers l'extérieur.
Soyez prudent avec cette partie, en raison de son tranchant.

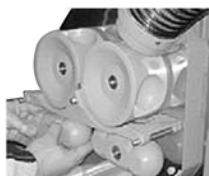

Instructions Français

Pour les modèles avec l'élément supérieur d'alimentation, tournez doucement le panier métallique supérieure tout le chemin vers la gauche, puis tirez doucement. Retirer le plat tournant en dévissant la vis vers la droite.



Nettoyer soigneusement toutes les parties, et le bloc de la machine à l'eau froide et de détergent.

Ne pas utiliser de produits abrasifs ni corrosifs, car ils pourraient nuire à l'composé des éléments de la machine. Ne pas nettoyer la machine avec de l'eau sous pression.

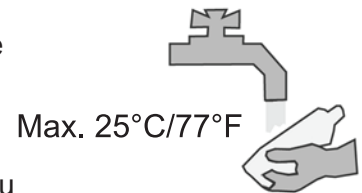

Sécher les composants du système et le bloc de la machine.

Assembler toutes les pièces dans l'ordre inverse. Aucun outil sont nécessaires pour assembler ou de démonter l'appareil. Toutes les pièces doivent s'adapter avec facilité et sans forcer.

Pour les machines self-service robinet, IMPORTANT: Afin d'assurer la parfaite hygiène de votre presse-agrumes, il est nécessaire de nettoyer régulièrement le robinet. Suivre les instructions selon le schéma.

Suivez les instructions illustrées.

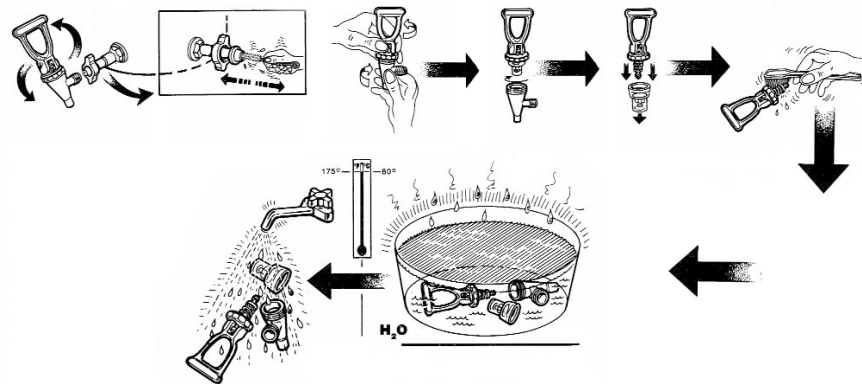

Pour les machines avec douche AUTOMATIQUE: Ce système ne remplace pas le nettoyage quotidien de la machine. Il permet un nettoyage rapide au cours de la journée, de la région les oranges sont pressées.

Vous devez connecter un tuyau avec l'extrémité fileté 3/8» (filetage standard international commun) au raccordement d'eau de la machine et l'autre extrémité avec le filetage qui a la sortie d'eau.

Vous pouvez régler le débit d'eau en ouvrant et fermant le robinet. Le haut est fermé et le bas est ouvert.

Autre que le nettoyage quotidien, machines Omcan nécessitent aucun autre entretien de routine.

Instructions Français

DÉPANNAGE

NON	CAUSE POSSIBLE	SOLUTION
La machine ne fonctionne pas.	Machine débranché.	Branchez-le à la prise.
	Pas d'alimentation.	Vérifiez la fiche et la prise.
	Couvercle transparent égaré.	Assurez-vous qu'il est bien placé.
	Détecteurs de sécurité défectueux.	Appelez le service clientèle.
	Défectueux bouton ON / OFF.	Appelez le service clientèle.
	Circuit électrique défectueux.	Appelez le service clientèle.
La machine est bloquée tout en serrant est en cours.	Tension insuffisante.	Vérifier que la tension est selon indiquée sur l'étiquette d'identification.
	La taille des fruits mal.	Vérifiez la taille du fruit est, comme indiqué dans ce manuel.
Le positionneur est brisée ou pliée.	Égaré tambour ou positionnés.	Assurez-vous que les pièces sont bien placés.
Le robinet est bloqué.	Jus a des graines ou de pâtes excessive.	Dissimuler et nettoyer le robinet comme décrit dans le manuel.
La machine arrête toutes les quelques minutes.	Une ventilation insuffisante.	Vérifiez que les grilles de ventilation ne sont pas couverts.
	Surcharge électrique.	Appelez le service clientèle.

Instrucciones en Español

SEGURIDAD Y GARANTÍA

- Es responsabilidad del usuario leer las advertencias adjuntas antes de utilizar esta máquina.
- Después de quitar el embalaje, compruebe que el equipo no esté dañado. En caso de duda, no lo utilice y póngase en contacto Omcan.
- Los materiales de embalaje (bolsas de plástico, espuma, corcho, etc.) no deben dejarse al alcance de los niños, ya que son un peligro potencial.
- Antes de montar la máquina, por favor, asegúrese de que no hay piezas que quedan en el envase.
- La máquina tiene que tener un poco de ventilación a su alrededor con el fin de realizar de forma adecuada.
- Para los modelos en un soporte, recuerde poner los frenos en las ruedas delanteras para evitar que en movimiento no deseado.
- Antes del uso, limpie toda la zona de prensado, VER INSTRUCCIONES DE LIMPIEZA en Mantenimiento.
- Nunca ponga en marcha la máquina sin asegurarse de que todos los componentes están en su lugar correcto, en especial la portada de lo contrario el detector de seguridad no permitirá que la máquina funcione.

Instrucciones en Español

- Al utilizar la máquina, no lo toque ni el acceso a las partes móviles ni de manos ni con cualquier utensilio.
- Máquina nunca debe ser operado por personal de menor importancia o sin experiencia y sin supervisión.
- Compruebe que el voltaje de la toma de corriente es de acuerdo a la tensión indicada en la etiqueta en la parte técnica de su máquina.
- No utilice un cable de extensión. Si decide hacerlo, es bajo su propia responsabilidad, utilice sólo la extensión que está en buenas condiciones y adecuada para la potencia de la máquina. El cable de extensión debe colocarse de modo que nadie puede tirar de él o tropezar.
- No permita que el cable entre en contacto con superficies calientes.
- Para protegerse contra el riesgo de choque eléctrico y lesiones personales, no sumerja el cable, el enchufe o el aparato en agua o cualquier otro líquido.
- Este producto está diseñado para uso en interiores, no exponga este aparato a la lluvia ni a la humedad y no lo use al aire libre o con las manos mojadas.
- Siempre coloque la máquina sobre una superficie seca, estable y nivelada.
- Para desconectarse de la toma de corriente tirar del enchufe suavemente. Nunca tire del cordón.
- El uso de accesorios no recomendados por el fabricante puede causar incendios, descargas eléctricas o lesiones, utilice siempre repuestos originales.

EL TAMAÑO ADECUADO DE NARANJA PARA OBTENER MEJORES RESULTADOS ES 60-80MM (2.4 A 3.1 PULGADAS) DE DIÁMETRO.

- Se recomienda lavar la fruta antes de la extracción del zumo.
- No utilice la máquina fuera del rango de temperatura: (de -20° a 40°C / 104°F a -4°).
- El fabricante declina cualquier responsabilidad por daños derivados de un uso inadecuado, descuidado o negligente de los equipos, así como de su uso por personas no autorizadas.

Debido a los altos estándares de fabricación y controles de calidad estrictos, te garantizamos el perfecto rendimiento de nuestras máquinas.

ESTA GARANTÍA NO CUBRE: La rotura o debilidad de cualquier parte o componente como consecuencia de la incorrecta o inadecuada instalación, mal uso o negligencia. Por otra parte, nosotros no seremos responsables de los daños causados por el desgaste normal por el uso, reparación o modificación de cualquier parte de la máquina realizada por cualquier persona no autorizada. Para cumplir con los términos de la garantía, todas las reparaciones deben ser realizadas por nuestro departamento técnico o el distribuidor oficial Omcan.

Cualquier falsificación de la documentación de la garantía, o la pérdida o daños a la placa de identificación de la máquina, se anulará la garantía del fabricante.

USUARIOS RESIDENCIALES: El proveedor no asume ninguna responsabilidad por la cobertura de piezas o mano de obra por fallas de componentes u otros daños resultantes de la instalación en aplicaciones residenciales o no comerciales. Se reserva el derecho a denegar el envío para uso residencial; si esto ocurre, se le notificará lo antes posible.

5 AÑOS DE GARANTÍA EN PIEZAS Y 1 AÑO EN MANO DE OBRA



Instrucciones en Español

Dentro del período de garantía, póngase en contacto Omcan Inc. al 1-800-465-0234 para programar una Omcan técnico autorizado para reparar el equipo local.

Mantenimiento no autorizada anulará la garantía. La garantía cubre los fallos eléctricos y piezas, no un uso inadecuado.

Por favor, vea <https://omcan.com/disclaimer> para obtener información completa.

ADVERTENCIA:

Las piezas de embalaje se clasifican como residuos sólidos urbanos y por lo tanto pueden ser eliminados sin dificultad.

En cualquier caso, para el reciclaje adecuado, le sugerimos comercialización de esos productos por separado (residuos diferenciados) de acuerdo con las normas vigentes.

NO DESECHE LOS MATERIALES DE EMBALAJE EN EL MEDIO AMBIENTE!

ESPECIFICACIONES TÉCNICAS

MINIMAX

Modelo	JE-ES-0015	JE-ES-0015-S
HP	0.75 HP	
Diámetro de la fruta	2.36" - 3.15" / 60 - 80mm	
Capacidad del alimentador	6 Oranges	
Cubo de cáscara	19.8 lbs. / 9 kgs.	
Producción	15 oranges per minute	
Eléctrico	110-120V / 60Hz / 1	
Corriente	9 / 8.6 A	
Dimensiones	17.7" x 19.3" x 33" / 450 x 490 x 838mm	
Peso	113.1 lbs. / 51.3 kgs.	
Número de artículo	39517	39518

Instrucciones en Español

MINIMATIC

Modelo	JE-ES-0015-F	JE-ES-0015-T
HP	0.75 HP	
Diámetro de la fruta	2.36" - 3.15" / 60 - 80mm	
Capacidad del alimentador	13.2 lbs. / 6 kgs.	
Cubo de cáscara	19.8 lbs. / 9 kgs.	
Producción	15 oranges per minute	
Eléctrico	110-120V / 60Hz / 1	
Corriente	9 / 8.6 A	
Dimensiones	17.7" x 19.3" x 36.6" / 450 x 490 x 930mm	
Peso	119.9 lbs. / 54.4 kgs.	
Número de artículo	39519	39520

TOP

Modelo	JE-ES-0028-F	JE-ES-0028-T
HP	0.75 HP	
Diámetro de la fruta	2.36" - 3.15" / 60 - 80mm	
Capacidad del alimentador	39 lbs. / 18 kgs.	
Cubo de cáscara	44 lbs. / 20 kgs.	
Producción	28 oranges per minute	
Eléctrico	110-120V / 60Hz / 1	
Corriente	9 / 8.6 A	
Dimensiones	19.7" x 24.4" x 39" / 500 x 620 x 991mm	
Peso	104.7 lbs. / 47.5 kgs.	
Número de artículo	39522	39521

FAST TOP

Modelo	JE-ES-0045	JE-ES-0045-B
HP	0.75 HP	
Diámetro de la fruta	2.36" - 3.15" / 60 - 80mm	
Capacidad del alimentador	39 lbs. / 18 kgs.	
Cubo de cáscara	44 lbs. / 20 kgs.	
Producción	45 oranges per minute	
Eléctrico	110-120V / 60Hz / 1	
Corriente	9 / 8.6 A	
Dimensiones	19.7" x 24.4" x 39" / 500 x 620 x 991mm	
Peso	104.7 lbs. / 47.5 kgs. (188 lbs. / 83.5 kgs. with stand)	
Número de artículo	40531	40547

Instrucciones en Español

BIG BASIC

Modelo	JE-ES-0028-BB
HP	0.75 HP
Diámetro de la fruta	3" - 3.8" / 76 - 97mm
Capacidad del alimentador	6 Fruits
Cubo de cáscara	44 lbs. / 20 kgs.
Producción	28 fruits per minute
Eléctrico	110-120V / 60Hz / 1
Corriente	4.1 / 3.7 A - 9 / 8.6 A
Dimensiones	17" x 28.7" x 33.8" / 432 x 729 x 859mm
Peso	93.9 lbs. / 42.6 kgs.
Número de artículo	41965

INSTALACIÓN

Proceda a montar todas las piezas que, por razones de transporte vienen desmontados en su ubicación correcta.

SET UP DE LA MÁQUINA

Minimax: Afloje el tornillo de mano y coloque el tubo de alimentación. Coloque el cubo de la cáscara y el jugo de la bandeja.



Minimatic: Afloje el tornillo y el tornillo del alimentador de cabeza, coloque el tubo de alimentación. Coloque el cubo de la cáscara y el jugo de la bandeja.

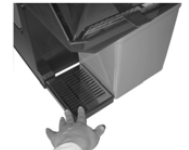

Instrucciones en Español

Top/Fast Top: Coloque la canasta, quitar el filtro y la pantalla de la cubierta. Montar el tubo de alimentación. Vuelva a colocar la cubierta de la pantalla y el filtro. Finalmente colocar los cubos de cáscara y el juco de la bandeja.

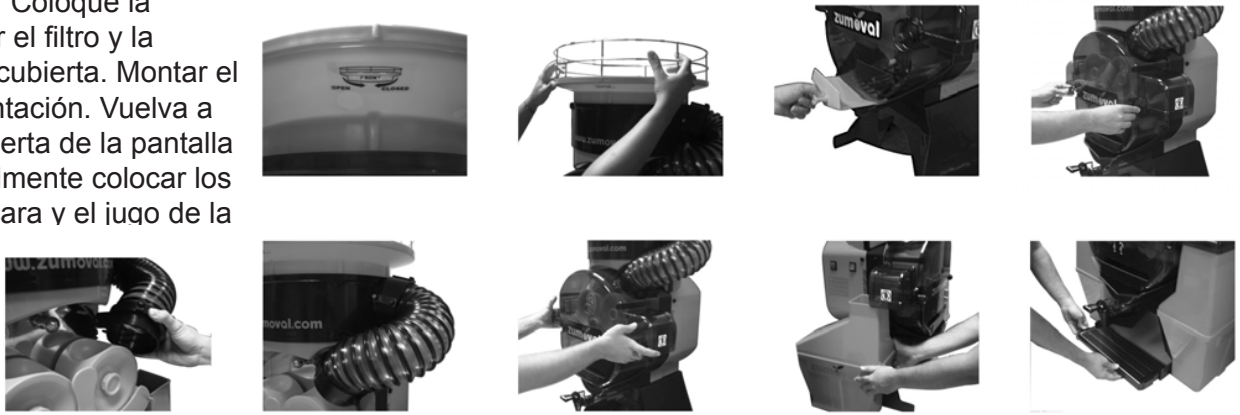

Conecte la máquina a una toma eléctrica normal con la protección del suelo.

OPERACIÓN

PANTALLA DIGITAL FÁCIL DE USAR

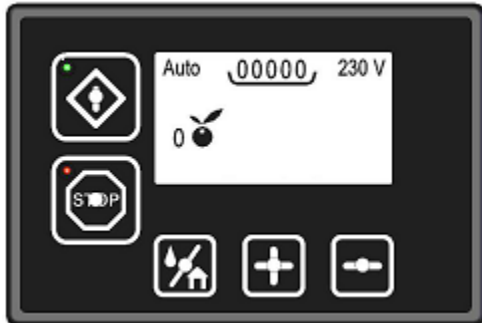

- Cantidad de naranjas exprimidas.
- Voltaje entrante.
- Selección de la modalidad de operación.
 - Usando la llave automática (cuando disponible).
 - Por la cantidad de naranjas exprimidas.
- Rotación reversa.
- Detección de avería.
- Desmontaje fácil: función pare horizontal para limpieza.
- Temporizador y límite de exprimido.

Proceda a introducir naranjas a través de la sonda de alimentación, o la cesta de la alimentación (según el modelo).

Instrucciones en Español

PARA COMENZAR EL PROCESO EXPRIME

Encienda el interruptor, que está situado en la parte superior derecha de la máquina (posición I).

LAS MÁQUINAS CON TAP SELF SERVICE:

Gire el interruptor de uno mismo a la posición AUT, pulse el grifo (Tal como se indica en la etiqueta en la pantalla de la cubierta).

LAS MÁQUINAS CON PROGRAMADOR:

Una vez que el interruptor se ha encendido, presionar uno de los botones rojos situados en la parte frontal de las máquinas. Los botones se refieren a 1, 2, o 3 naranjas, mientras que el botón de la derecha se refiere a la compresión de continuar.

LAS MÁQUINAS CON DETECTOR DE NIVEL JUGO:

Una vez que el interruptor de la máquina se enciende, gire el interruptor detector a la posición AUT. En modo manual, el interruptor se puede utilizar.

MÁQUINAS CON DUCHA AUTOMÁTICO:

Una vez que el tubo de agua ha sido conectado a la conexión en la parte posterior de la máquina, pulsar el botón verde. La máquina tiene que trabajar en capaz de conectar la ducha.

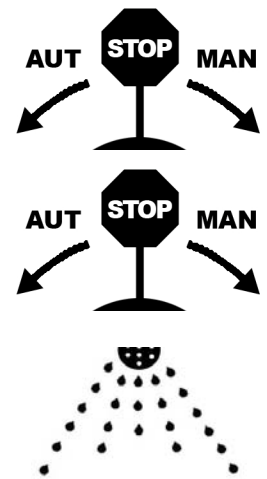

PARA DETENER EL PROCESO EXPRIME

Pare la máquina pulsando el botón rojo 0 en el interruptor de encendido / apagado.

LAS MÁQUINAS CON TAP SELF SERVICE:

Cierre el grifo y encender la luz roja se apaga (STOP) como se indica en la etiqueta en la pantalla de la cubierta.

LAS MÁQUINAS CON PROGRAMADOR:

Las 3 primeras opciones se detienen automáticamente. Para detener el modo de continuar, presionar de nuevo este botón y poner el interruptor (Pos.0).

LAS MÁQUINAS CON DETECTOR DE NIVEL JUGO:

En "AUT", la máquina se detiene automáticamente, una vez que el dispensador está lleno. Si la máquina funciona en "MAN", desconecte el interruptor de encendido.

MÁQUINAS CON DUCHA AUTOMÁTICO:

Pulse el botón de ducha y cerrar la conexión de agua.

AUT = automático

MAN = manual

Instrucciones en Español

MANTENIMIENTO

LIMPIEZA Y MANTENIMIENTO

Una vez que la extracción de zumo ha sido terminada, detener la máquina de acuerdo con el modelo.

Deja las varillas de la exprimidor de doble tambor en una posición vertical.

Asegúrese de que las partes exprimidor masculinos son horizontales.

Desenchufe el equipo de la toma de corriente.

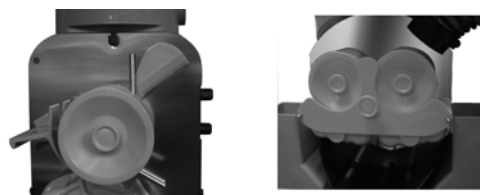

QUITE EL FILTRO JUGO

Vacíe el cubo cáscara.



Retire la cubierta frontal, moviéndose lentamente hacia arriba y hacia.



Quite la cubierta delantera, quitando los dos tornillos laterales.



MINIMAX – MINIMATIC

Retire el posicionador, empujándolo hacia arriba.
Retirar el cuchillo, aflojando el tornillo de cuchillo (Tenga cuidado. El cuchillo está afilado). Quite la parte masculina exprimidor, aflojando el tornillo.

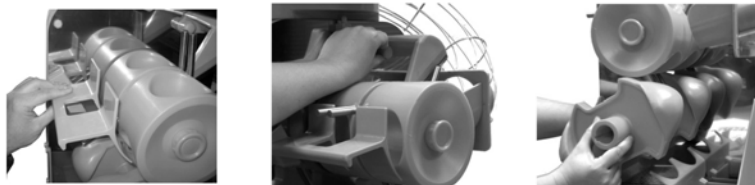

Retire el tambor exprimidor aflojando el tornillo.
Retire la segunda parte exprimidor masculino.



Instrucciones en Español

Retire el eyector.

Para los modelos con alimentador de cabeza:
Tome la placa de giro del alimentador, aflojando el tornillo.



TOP/FAST TOP

Afroje los cinco tornillos principales de las piezas del sistema de compresión.



Retire los dos tambores que exprimen, las dos partes masculinas y knifepiece tirando hacia el exterior. Tenga cuidado con esta parte, debido a su vanguardia.

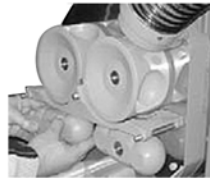

Para los modelos con el componente de alimentación superior, gire suavemente la canasta metálica superior de todo el camino hacia la izquierda y luego tire suavemente hacia arriba. Retire el plato girando aflojando el tornillo hacia la derecha.



Limpiar a fondo todas las piezas, y el bloque de la máquina con agua fría y detergente.

No utilice productos abrasivos ni corrosivos, ya que podrían dañar el compuesto de los elementos de la máquina. No limpie la máquina con agua a presión.

Secar los componentes del sistema y el bloque de la máquina.

Max. 25°C/77°F

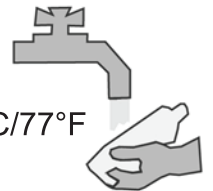

Ensamblar todas las piezas en orden inverso. No se necesitan herramientas para montar o desmontar la máquina. Todas las piezas deben encajar con facilidad y sin fuerza indebida.

Para máquinas con grifo de autoservicio, IMPORTANTE: Con el fin de garantizar la higiene perfecta de su exprimidor de naranja, es necesario limpiar periódicamente el grifo. Siga las instrucciones de acuerdo con el diagrama.

Instrucciones en Español

Siga las instrucciones que aparecen.

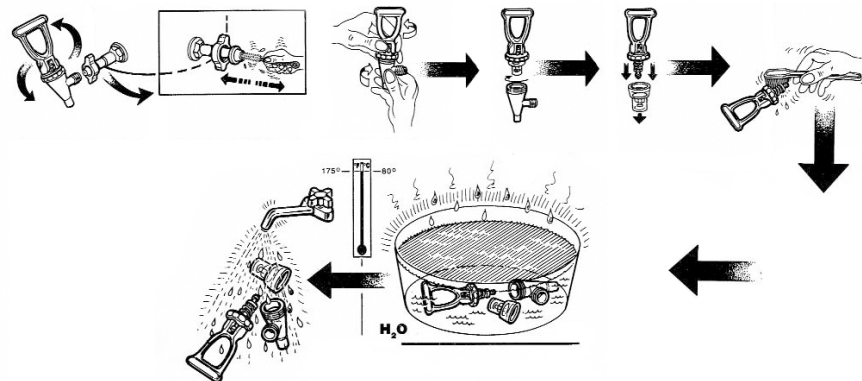

Para las máquinas con ducha AUTOMÁTICO: Este sistema no sustituye la limpieza diaria de la máquina. Permite una limpieza rápida durante el día, de la zona de las naranjas son exprimidas.

Debe conectar una manguera con el extremo de rosca de 3/8" (rosca estándar común internacional) a la conexión de agua de la máquina y el otro extremo con la rosca que tiene la salida de agua.

Puede regular el flujo de agua abriendo y cerrando el grifo. Arriba está cerrado y abajo está abierto.

Aparte de la limpieza diaria, máquinas Omcan no requieren otro mantenimiento de rutina.

SOLUCIÓN DE PROBLEMAS

FRACASO	POSIBLE CAUSA	SOLUCIÓN
La máquina no funciona.	Máquina desenchufado.	Conéctelo a la toma.
	No hay alimentación.	Compruebe el enchufe y el zócalo.
	Cubierta transparente fuera de lugar.	Asegúrese de que está bien colocado.
	Detectores de seguridad defectuosos.	Llamar servicio al cliente.
	Defectuoso botón ON / OFF.	Llamar servicio al cliente.
	Circuito eléctrico defectuoso.	Llamar servicio al cliente.
La máquina se bloquea al momento de apretar está en curso.	Tensión insuficiente.	Compruebe que la tensión es según se indica en la etiqueta de identificación.
	Tamaño incorrecto fruta.	Compruebe el tamaño de la fruta es como se muestra en este manual.
El posicionador está rota o torcida.	Tambor fuera de lugar o colocado.	Asegúrese de que las piezas están bien situados.

Instrucciones en Español

El grifo está bloqueado.	El jugo tiene semillas o pulpa excesiva.	Disimular y limpiar el grifo como se describe en el manual.
La máquina se detiene cada pocos minutos.	Ventilación insuficiente.	Compruebe que las rejillas de ventilación no estén cubiertos.
	Sobrecarga eléctrica.	Llamar servicio al cliente.

Parts Breakdown

Model JE-ES-0015-F 39519

Model JE-ES-0015-T 39520

Model JE-ES-0015 39517

Model JE-ES-0015-S 39518

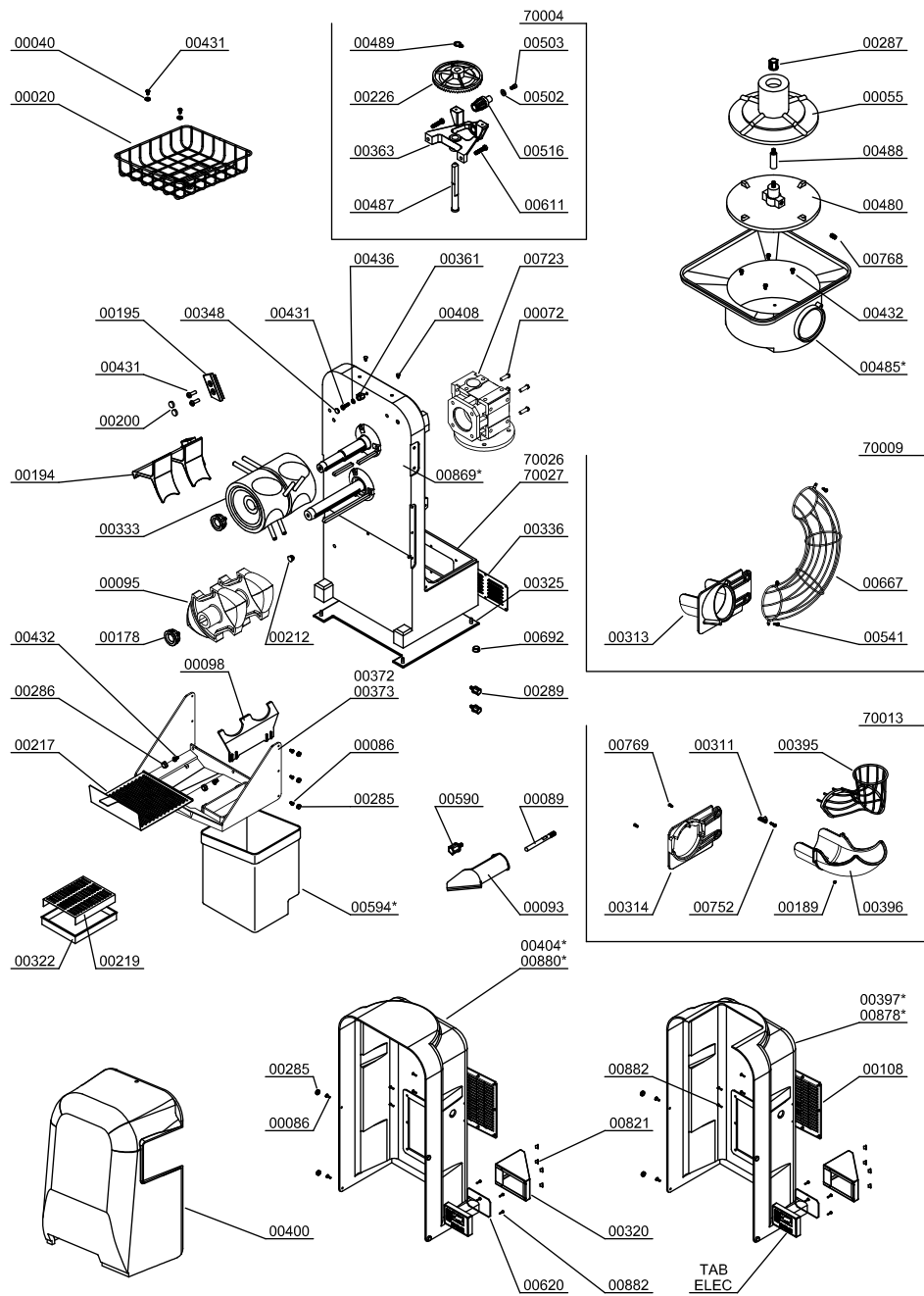

Parts Breakdown

Model JE-ES-0015-F 39519

Model JE-ES-0015-T 39520

Model JE-ES-0015 39517

Model JE-ES-0015-S 39518

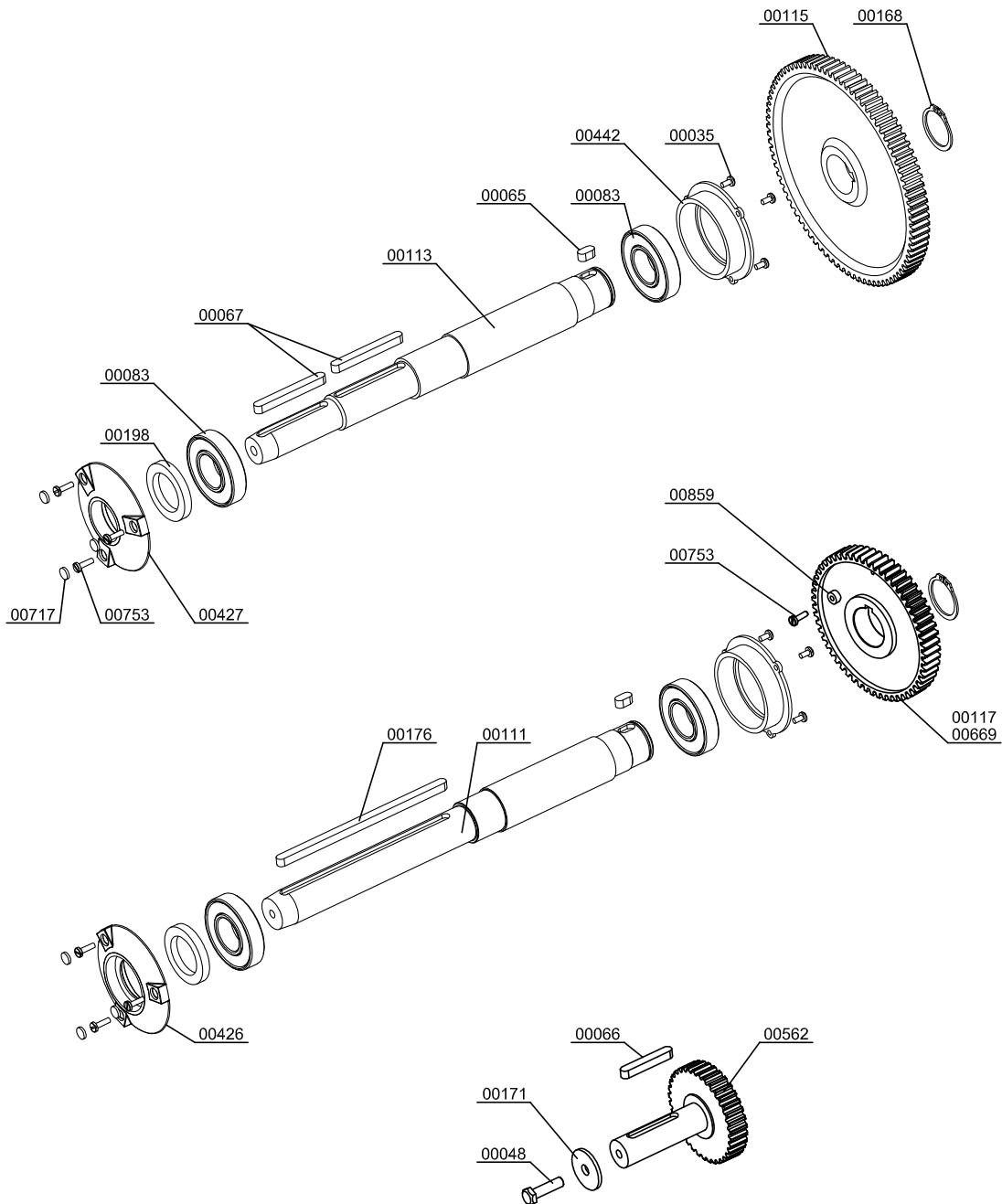

Parts Breakdown

Model JE-ES-0015-F 39519

Model JE-ES-0015-T 39520

Model JE-ES-0015 39517

Model JE-ES-0015-S 39518

STAINLESS STEEL SELF TAP OPTION

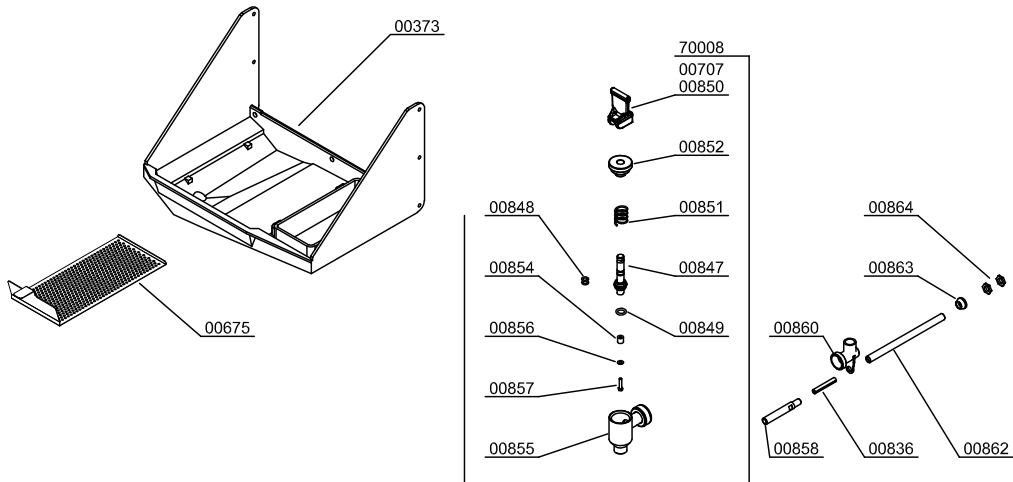

AUTOMATIC SHOWER OPTION

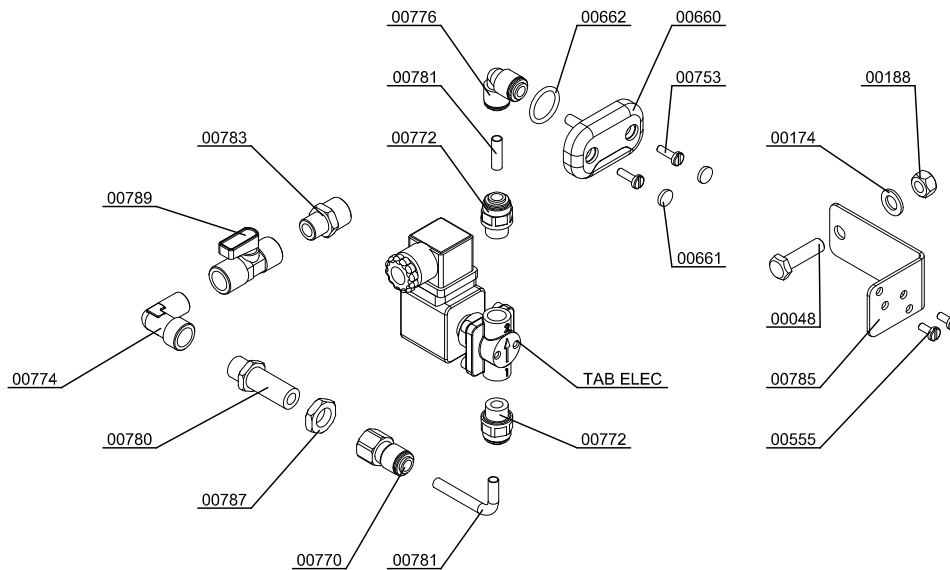



Parts Breakdown

Model JE-ES-0015-F 39519

Model JE-ES-0015-T 39520

Model JE-ES-0015 39517

Model JE-ES-0015-S 39518

Item No.	Description	Position	Item No.	Description	Position	Item No.	Description	Position
72499	Stainless Steel Basket for MXM	00020	72535	Plastic Lid M6 for MXM	00286	72580	Rustless Screw M2.9x10 Inox for MXM	00541
72500	Screw H M4x10 Zinc for MXM	00035	40592	Female Thumbscrew M8 for MXM	00287	72582	Rustless Screw M5x10 Inox for MXM	00555
72501	Rustless Washer DIN-9021 D06 for MXM	00040	72537	Male Thumbscrew M6 for MXM	00289	72583	Reducer Shaft for MXM	00562
72502	Screw H M8x30 Zinc for MXM	00048	72538	Feeder Tube Support Clamp for MXM	00311	40589	Male Thumbscrew M8 for MXM	00590
72503	Turning Feeder Plate for MXM	00055	72539	Feeder Tube Support MM for MXM	00313	72585	Peel Bucket for MXM	00594
72504	Cotter H 8x7x15 for MXM	00065	72540	Feeder Tube Support MX for MXM	00314	72586	Screw H M10x35 Zinc for MXM	00611
72505	Cotter H 8x7x50 for MXM	00066	AK891	E-Tron Basic Support for MXM	00320	AK892	E-Tron Joint for MXM	00620
72506	Rustless Cotter Inox 8x7x70 for MXM	00067	72541	Tray 150x120 for MXM	00322	64837	DC Shower Diffuser for MXM	00660
72507	Screw H M8x25 Zinc for MXM	00072	72542	Sump Base for MXM	00325	64838	DC Shower Diffuser Cap for MXM	00661
72508	Bearing 6007 for MXM	00083	72543	Squeezer Double Drum for MXM	00333	64839	DC O-Ring for MXM	00662
72509	Rustless Screw M4x10 Inox for MXM	00086	72545	Sump Grid for MXM	00336	72612	Feeder Tube Protection for MXM	00667
72510	Blade Rod-Positioner for MXM	00089	72547	Cover Screen Support Cap for MXM	00348	64840	Lower Gear for MXM	00669
40585	Knife Piece for MXM	00093	72548	Cover Screen Support for MXM	00361	40587	Rustless Juice Filter for MXM	00675
71506	Squeezer Male for MXM	00095	72549	Feeder Support for MXM	00363	64841	Plugging Cap Ø19mm for MXM	00692
40593	Ejector for MXM	00098	72550	Juice Tray for MXM	00372	AK893	Tap Handle for MXM	00707
72514	Ventilation Grid for MXM	00108	72551	Juice Tray (Self) for MXM	00373	72597	Lower Seal Protection for MXM	00717
72515	Lower Rustless Shaft for MXM	00111	72552	Feeder Tube Protection for MXM	00395	64842	Reducer for MXM	00723
72516	Upper Rustless Shaft for MXM	00113	72553	Feeder Tube for MXM	00396	64843	Rustless Screw M2.9x16 Inox for MXM	00752
72518	Upper Gear for MXM	00115	72554	Back Cover MM for MXM	00397	44090	Rustless Screw DIN-85 M4x14 Inox for MXM	00753
72519	Lower Gear for MXM	00117	39696	Cover Screen for MXM	00400	72589	Screw H M6x16 for MXM	00768
72520	C Clip Din 471 E-34 for MXM	00168	72556	Back Cover MX for MXM	00404	64845	Rustless Screw M4x16 Inox for MXM	00769
72521	Washer H D35-D09x3 Zinc for MXM	00171	72557	Plugging Cap Ø5x12mm for MXM	00408	64846	DC Adapter Female 6-1/4" for MXM	00770
72522	Rustless Washer Din-125 D08 Inox for MXM	00174	72560	Lower Seal Protection for MXM	00426	64847	DC Adapter Male 6-1/4" for MXM	00772
72523	Stainless Cotter 8x8x170 Inox for MXM	00176	72561	Upper Seal Protection for MXM	00427	64849	DC Elbow 6mm for MXM	00776
40590	Male Thumbscrew M8 for MXM	00178	72563	Rustless Screw M6x20 Inox for MXM	00431	64851	DC Hose 6mm for MXM	00781
64906	Nut H Zinc M8 for MXM	00188	72564	Rustless Screw M6x12 Inox for MXM	00432	64853	DC E-Valve Shower Support for MXM	00785
72526	Rustless Wingnut M4 Inox for MXM	00189	72565	Rustless Washer Din-6798 D06 Inox for MXM	00436	64855	DC Valve 1/4" for MXM	00789
40586	Positioner Orange Color for MXM	00194	64835	Sump Bearing Lid for MXM	00442	AK894	Plugging Cap for MXM	00821
72528	Positioner Guide for MXM	00195	72692	Traction Disc Feeder for MXM	00480	64856	Pin Detect D8 for MXM	00836
72529	Rubber Seal 35x50x07 for MXM	00198	72568	Head Feeder for MXM	00485	64857	Tap Plunger for MXM	00847
72530	Positioner Lid for MXM	00200	72569	Rustless Feeder Shaft for MXM	00487	64858	Plunger O-Ring Ø2 for MXM	00848
64834	Plugging Cap Ø16mm Black for MXM	00212	72570	Feeder Traction Disc Supply for MXM	00488	64859	Plunger O-Ring Ø4 for MXM	00849
40594	Rustless Juice Filter for MXM	00217	72693	C Clip DIN-471 E16 for MXM	00489	64860	Tap Handle for MXM	00850
72532	Luggage-Rack 150x120 for MXM	00219	72572	Washer H D28-D06x2 Zinc for MXM	00502	64861	Tap Spring for MXM	00851
72533	Gear Feeder 3 Horiz for MXM	00226	72573	Rustless Screw M6x10 Inox for MXM	00503	64862	Tap Cap for MXM	00852
72534	Plastic Lid M4 for MXM	00285	72574	Gear Feeder for MXM	00516	64863	Magnet 10-10 for MXM	00854

Parts Breakdown

Model JE-ES-0015-F 39519

Model JE-ES-0015-T 39520

Model JE-ES-0015 39517

Model JE-ES-0015-S 39518

Item No.	Description	Position	Item No.	Description	Position	Item No.	Description	Position
64864	Tap Body for MXM	00855	64871	Tube DET Nut for MXM	00863	64876	Self Service Inox Tap Kit for MXM	70008
64865	Rustless Washer Din-125 D05 Inox for MXM	00856	64872	Nut H CRO M12x100 for MXM	00864	72615	Feeder Tube Kit MM for MXM	70009
64866	Rustless Screw for MXM	00857	AK895	Frontal Sheet for MXM	00869	72616	Feeder Tube Kit MX for MXM	70013
64867	Tap Capsule for MXM	00858	64873	Back Cover for MXM	00878	72617	Sump Kit for MXM	70026
64868	Magnet 10-05 for MXM	00859	64874	Back Cover for MXM	00880	64877	Shower Sump Kit for MXM	70027
64869	Tap Support for MXM	00860	64875	Rustless Screw M2.9x13 Inox for MXM	00882			
64950	Tube DET-180 Stainless Steel for MXM	00862	72614	Feeder Support Kit for MXM	70004			

Parts Breakdown

Model JE-ES-0028-F 39522

Model JE-ES-0028-T 39521

Model JE-ES-0045 40531

Model JE-ES-0045-B 40547

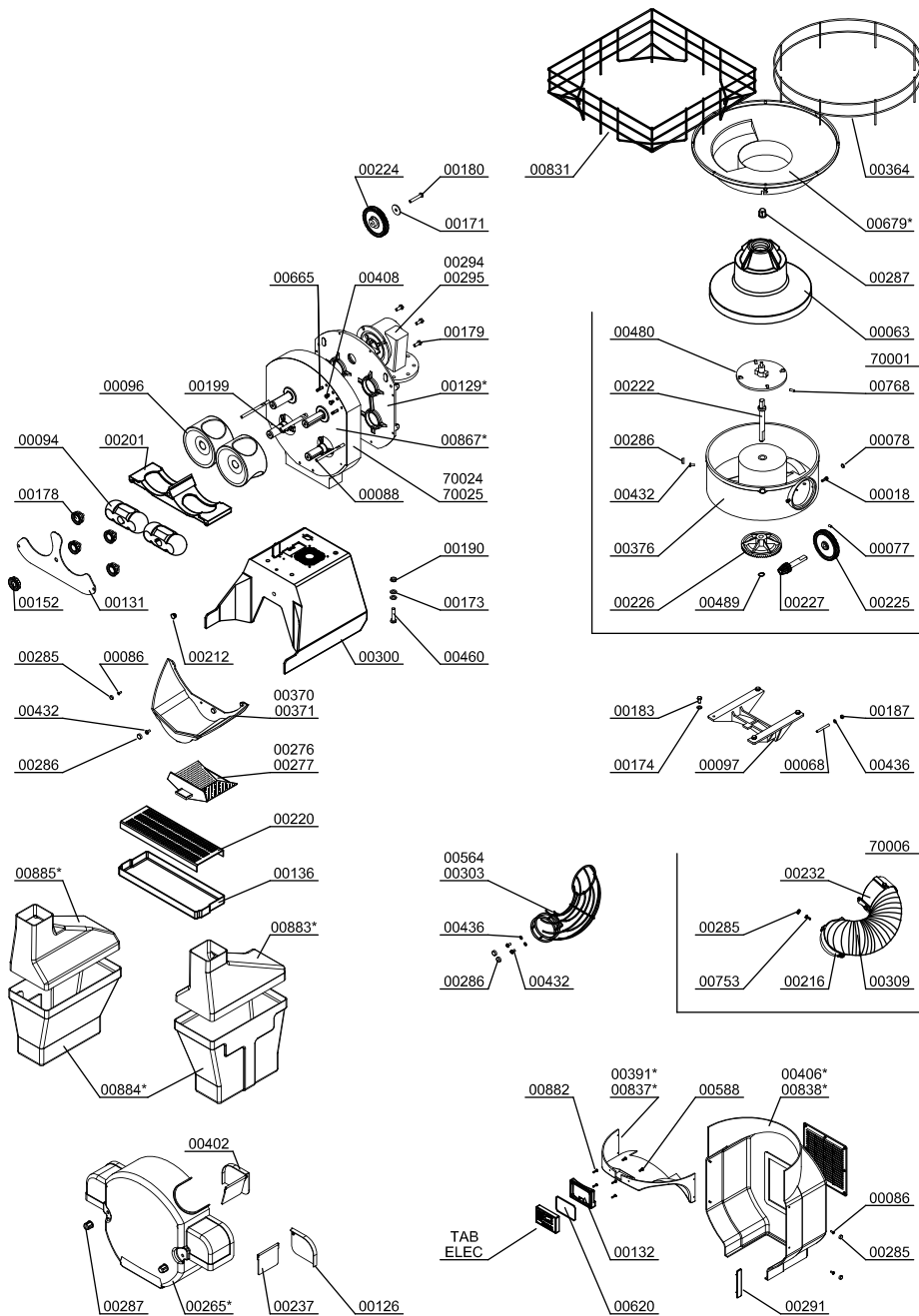

Parts Breakdown

Model JE-ES-0028-BB 41965

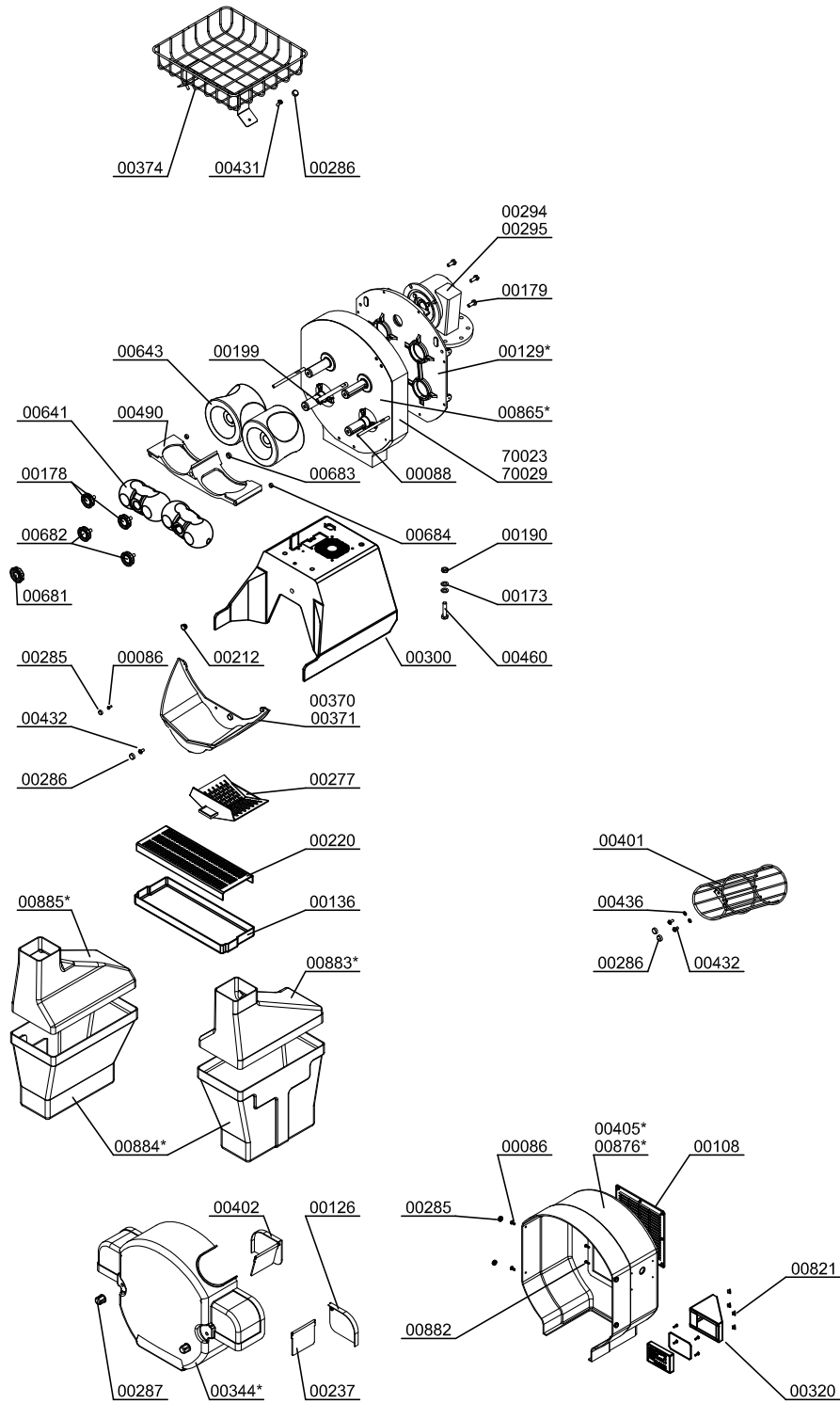

Parts Breakdown

Model JE-ES-0028-F 39522

Model JE-ES-0028-T 39521

Model JE-ES-0045 40531

Model JE-ES-0045-B 40547

Model JE-ES-0028-BB 41965

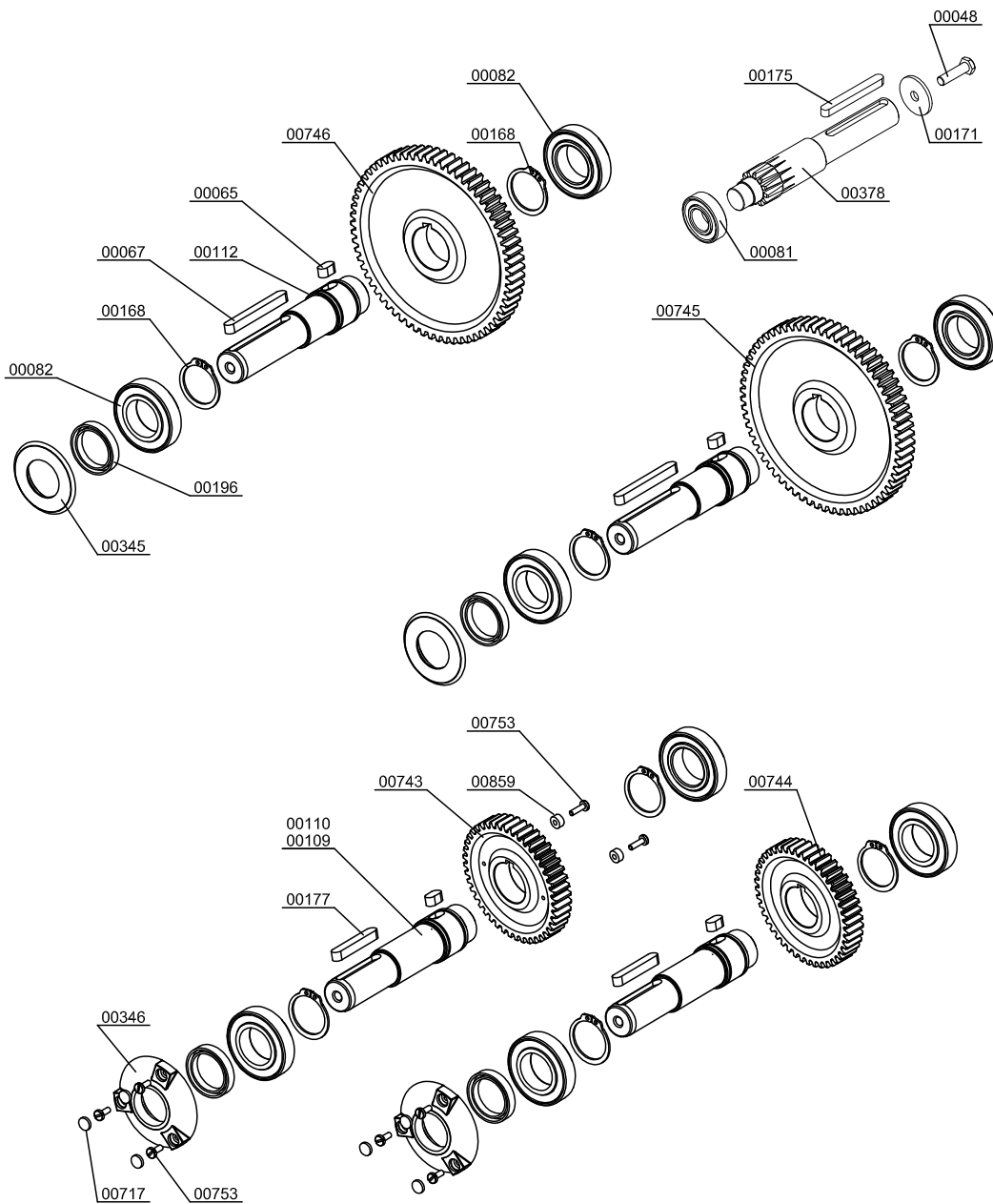

Parts Breakdown

Model JE-ES-0028-F 39522

Model JE-ES-0028-T 39521

Model JE-ES-0045 40531

Model JE-ES-0045-B 40547

Model JE-ES-0028-BB 41965

STAINLESS STEEL SELF TAP OPTION

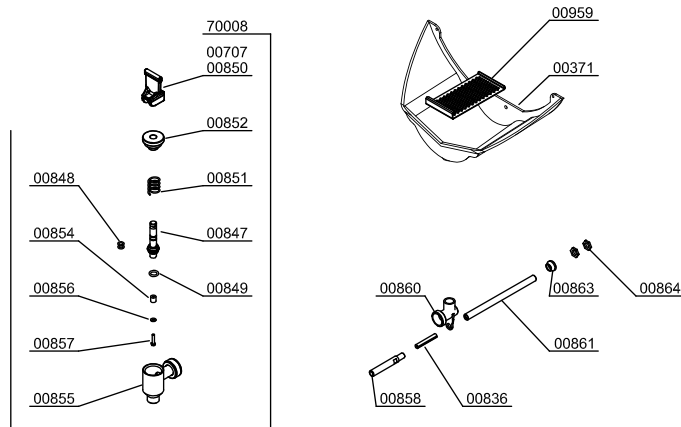

AUTOMATIC SHOWER OPTION

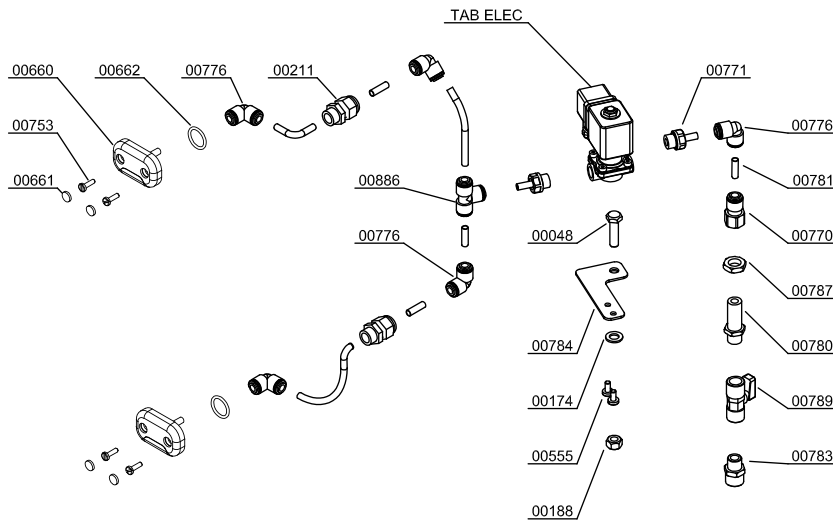

Parts Breakdown

Model JE-ES-0028-F 39522

Model JE-ES-0028-T 39521

Model JE-ES-0045 40531

Model JE-ES-0045-B 40547

Model JE-ES-0028-BB 41965

SELF SERVICE STAND OPTION

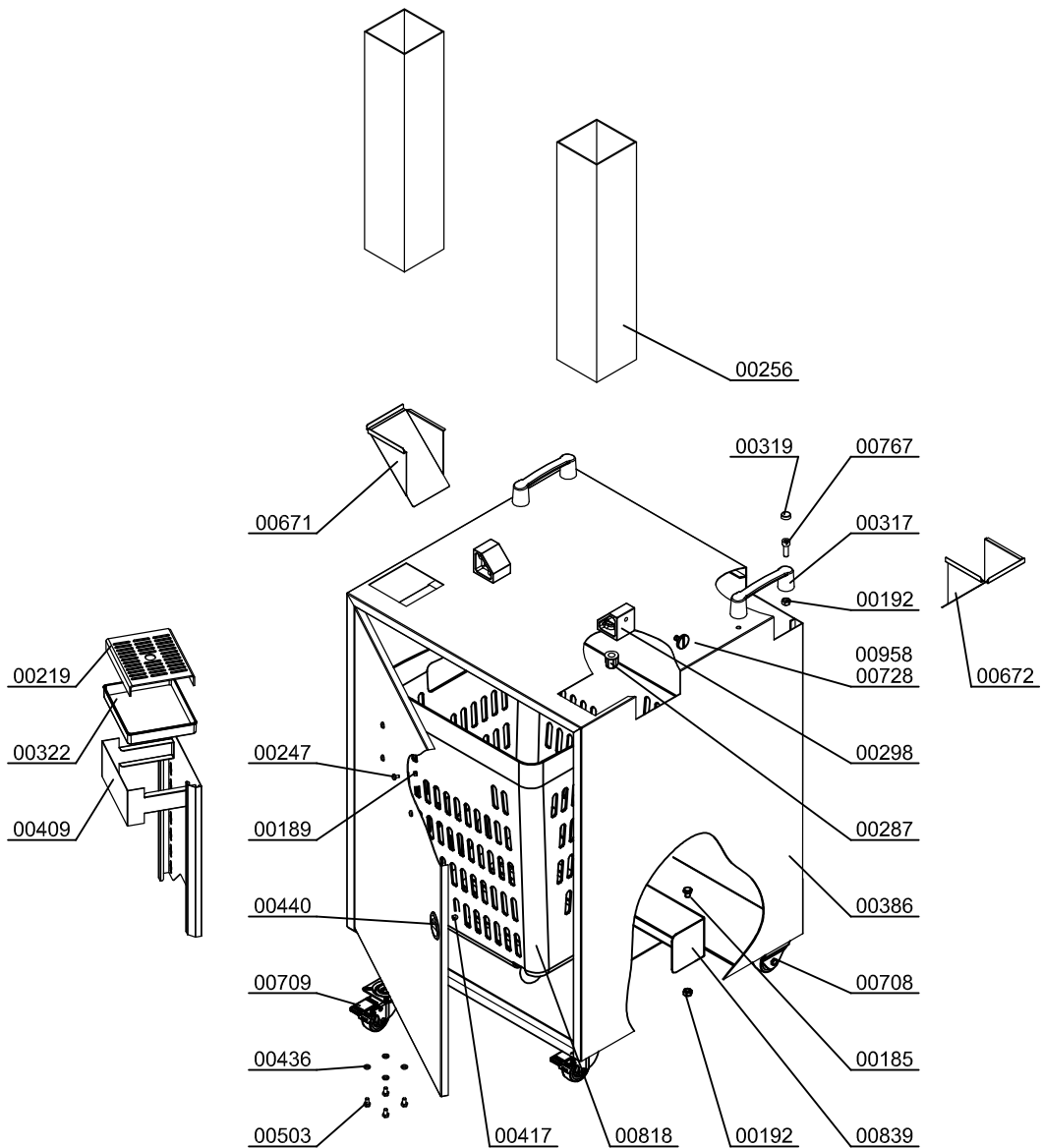

Parts Breakdown

Model JE-ES-0028-F 39522

Model JE-ES-0028-T 39521

Model JE-ES-0045 40531

Model JE-ES-0045-B 40547

Model JE-ES-0028-BB 41965

DISPENSER STAND OPTION

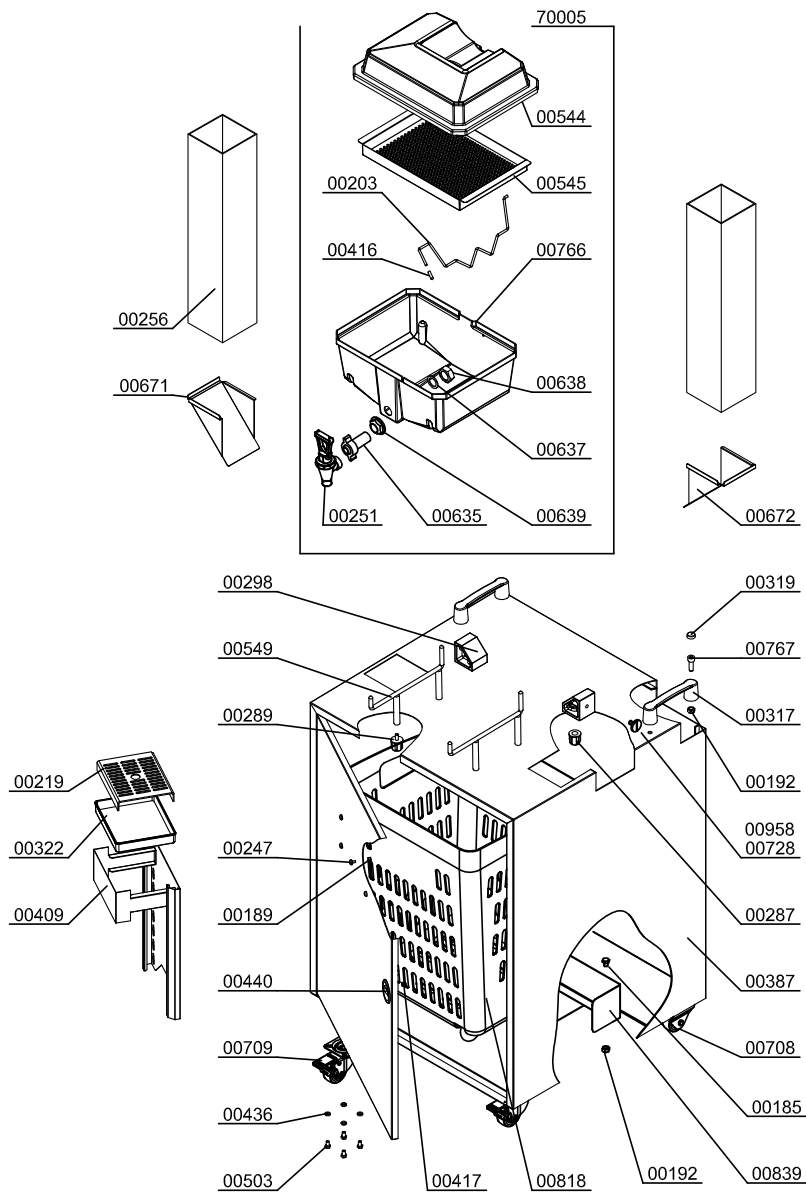



Parts Breakdown

Model JE-ES-0028-F 39522

Model JE-ES-0028-T 39521

Model JE-ES-0045 40531

Model JE-ES-0045-B 40547

Model JE-ES-0028-BB 41965

Item No.	Description	Position	Item No.	Description	Position	Item No.	Description	Position
72618	Rustless Screw M5x18 Inox for BTM	00018	72649	Screw H M8x50 for BTM	00180	72537	Male Thumbscrew M6 for BTM	00289
72502	Screw H M8x30 Zinc for BTM	00048	72650	Rustless Screw M8x16 for BTM	00183	72672	Back Cover Joint BK for BTM	00291
72620	Turning Feeder Plate Top for BTM	00063	64905	Rustless Screw M8x10 for BTM	00185	72673	Reducer 14-160 R:1/28 for BTM	00294
72504	Cotter H 8x7x15 for BTM	00065	72651	Nut H Zinc M6 for BTM	00187	64912	Reducer 14-160 R:1/20 for BTM	00295
72506	Rustless Cotter Inox 8x7x70 for BTM	00067	64906	Nut H Zinc M8 for BTM	00188	64913	Support Bracket Stand for BTM	00298
72623	Screw H M6x55 for BTM	00068	72526	Rustless Wingnut M4 Inox for BTM	00189	72674	Baseplate for BTM	00300
72626	Screw H M6x10 for BTM	00077	72653	Nut H Zinc M10 for BTM	00190	AK897	Feeder Tube for BTM	00303
64901	Plugging Cap PVC M5 Black for BTM	00078	64907	Rustless Nut M8 Inox for BTM	00192	43980	Feeder Plastic Tube Section for BTM	00309
72627	Bearing 6004 for BTM	00081	72654	Rubber Seal 30x40x06 for BTM	00196	64914	Handle Stand for BTM	00317
72628	Bearing 6006 for BTM	00082	72655	Ejector Rod M12 for BTM	00199	64915	Lid Handle Stand for BTM	00319
72509	Rustless Screw M4x10 Inox for BTM	00086	39699	Blade Ejector for BTM	00201	AK891	E-Tron Support for BTM	00320
72630	Screen Rod M8 for BTM	00088	64908	Shaker Dispenser for BTM	00203	72541	Tray 150x120 for BTM	00322
72631	Squeezer Male for BTM	00094	72657	DC Hose Fixing PG9 V-Tec 9GR for BTM	00211	39695	Cover Screen for BTM	00344
72632	Squeezer Drum for BTM	00096	64834	Plugging Cap Ø16mm Black for BTM	00212	43977	Upper Seal Protection Sup for BTM	00345
72633	Feeder Support for BTM	00097	42759	Lower Tube Connection for BTM	00216	43978	Lower Seal Protection Inf for BTM	00346
72514	Ventilation Grid for BTM	00108	72532	Luggage-Rack 150x120 for BTM	00219	72728	Protect Basket Top for BTM	00364
64902	Lower Rustless Shaft Cont/Pos for BTM	00109	72659	Luggage-Rack 350x130 for BTM	00220	72679	Juice Tray BK for BTM	00370
72635	Lower Rustless Shaft for BTM	00110	72660	Rustless Feeder Shaft for BTM	00222	72680	Juice Tray BK Self for BTM	00371
AK896	Upper Rustless Shaft for BTM	00112	72661	Gear Feeder 1 Reduct for BTM	00224	64918	Rustless Basket for BTM	00374
72637	Cover Screen Right Lid for BTM	00126	72662	Gear Feeder 2 Cabez for BTM	00225	72681	Head Feeder BK for BTM	00376
72638	Sump Cover for BTM	00129	72533	Gear Feeder 3 Horiz for BTM	00226	72719	Reducer Shaft F-125 for BTM	00378
72639	Protect Juice Screen NA for BTM	00131	43976	Gear Feeder 4 Eje for BTM	00227	64919	Self Service Stand S/M for BTM	00386
64903	E-Tron Top Support for BTM	00132	72665	Upper Tube Connection BK for BTM	00232	64920	Dispenser Stand S/M for BTM	00387
72640	Tray 350x130 for BTM	00136	72666	Cover Screen Balance for BTM	00237	72682	Front Cover NA for BTM	00391
40591	Female Thumbscrew M12 for BTM	00152	64909	Stand Tray Rustless Screw M4x12 for BTM	00247	64921	Feeder Tube D100 for BTM	00401
72520	C Clip Din 471 E-34 for BTM	00168	64117	Tap for BTM	00251	72683	Cover Screen Left Lid for BTM	00402
72521	Washer H D35-D09x3 Zinc for BTM	00171	64910	Down Tube Stand Stainless Steel for BTM	00256	72684	Back Cover Basic NA for BTM	00405
72644	Washer H Zinc Din-125 D10 for BTM	00173	39695	Cover Screen for BTM	00265	72685	Back Cover Top for BTM	00406
72522	Rustless Washer Din-125 D08 Inox for BTM	00174	40596	Juice Filter for BTM	00276	72557	Plugging Cap Ø5x12mm for BTM	00408
42173	Cotter H 8x7x70 for BTM	00175	64911	Juice Filter Big for BTM	00277	64922	Stand Support Tray Stainless Steel Dispenser for BTM	00409
72647	Rustless Cotter 8x7x50 for BTM	00177	72534	Plastic Lid M4 for BTM	00285	64923	Plugging Cap PVC M4 Black for BTM	00416
40590	Male Thumbscrew M8 for BTM	00178	72535	Plastic Lid M6 for BTM	00286	64924	Plugging Cap PVC M6 Black for BTM	00417
64904	Screw H Zinc M8x20 for BTM	00179	40592	Female Thumbscrew M8 for BTM	00287	72563	Rustless Screw M6x20 Inox for BTM	00431

Parts Breakdown

Model JE-ES-0028-F 39522

Model JE-ES-0028-T 39521

Model JE-ES-0045 40531

Model JE-ES-0045-B 40547

Model JE-ES-0028-BB 41965

Item No.	Description	Position	Item No.	Description	Position	Item No.	Description	Position
72564	Rustless Screw M6x12 Inox for BTM	00432	64937	Separating Rod D8 for BTM	00684	64861	Tap Spring for BTM	00851
72565	Rustless Washer DIN-6798 D06 Inox for BTM	00436	AK893	Tap Handle for BTM	00707	64862	Tap Cap for BTM	00852
64925	Closing Device for BTM	00440	AK899	Fixed Wheel for BTM	00708	64863	Magnet 10-10 for BTM	00854
72691	Screw H Zinc M10x45 for BTM	00460	AK900	Rotatory Brake Wheel for BTM	00709	64864	Tap Body for BTM	00855
72692	Traction Disc Feeder for BTM	00480	72597	Lower Seal Protection for BTM	00717	64865	Rustless Washer DIN-125 D05 Inox for BTM	00856
72693	C Clip DIN-471 E16 for BTM	00489	64938	Rustless Nut M8 Inox for BTM	00728	64866	Rustless Screw M4x20 Inox for BTM	00857
14904	Blade Ejector D80-D100 for BTM	00490	72717	Lower Gear 0 for BTM	00743	64867	Tap Capsule for BTM	00858
72573	Rustless Screw M6x10 Inox for BTM	00503	72718	Lower Gear 1 for BTM	00744	64868	Magnet 10-05 for BTM	00859
40602	Juicer Dispenser Cover for BTM	00544	72715	Upper Gear 0 for BTM	00745	64869	Tap Support for BTM	00860
64926	Rustless Filter for BTM	00545	72716	Upper Gear 1 for BTM	00746	64870	Tube Det 150 for BTM	00861
64927	Dispenser Support Inox for BTM	00549	44090	Rustless Screw DIN-85 M4x14 Inox for BTM	00753	64871	Tube Det Nut for BTM	00863
72582	Rustless Screw M5x10 Inox for BTM	00555	40603	Juice Dispenser Base for BTM	00766	64872	Nut H Cro M12x100 for BTM	00864
AK898	Feeder Tube for BTM	00564	64941	Rustless Screw M8x25 Inox for BTM	00767	AK902	Frontal Sheet for BTM	00865
64928	Rustless Screw M3.9x13 Inox for BTM	00588	72589	Screw H M6x16 for BTM	00768	AK903	Frontal Sheet for BTM	00867
AK892	E-Tron Joint for BTM	00620	64846	DC Adapter Female 6-1/4" for BTM	00770	64951	Back Cover NA E-Tron for BTM	00876
64118	Coupling Tap for BTM	00635	64942	DC Adapter Male 6-1/4" for BTM	00771	64875	Rustless Screw M2.9x13 Inox for BTM	00882
64116	Tap Washer for BTM	00637	64849	DC Elbow 6mm for BTM	00776	72706	Right Peel Bucket Lid for BTM	00883
64115	Tap Nut for BTM	00638	64851	DC Hose 6mm for BTM	00781	72707	Peel Bucket Base for BTM	00884
64932	Tap Nut Valon for BTM	00639	64943	DC E-Valve Shower Support for BTM	00784	72708	Left Peel Bucket Lid for BTM	00885
15403	Squeezer Male D80-D100 for BTM	00641	64855	DC Valve 1/4" for BTM	00789	64952	DC Tee 6mm for BTM	00886
15405	Squeezer Drum D80-D100 for BTM	00643	64946	Trolley 52L for BTM	00818	AK904	Rustless Screw for BTM	00958
64837	DC Shower Diffuser for BTM	00660	AK894	Plugging Cap for BTM	00821	AK244	Rustless Self Filter for BTM	00959
64838	DC Shower Diffuser Cap for BTM	00661	AK901	Protec Basket for BTM	00831	72736	Head Feeder Kit Top BK for BTM	70001
64839	DC O-Ring for BTM	00662	64856	Pin Detect D8 for BTM	00836	64953	Juice Dispenser Kit for BTM	70005
64933	Stainless Steel Tube Guide M6x25 for BTM	00665	64947	Front Cover Top NA E-Tron for BTM	00837	40599	Feeder Tube Kit Top for BTM	70006
64934	Stand Left Ramp Stainless Steel for BTM	00671	64948	Back Cover Top NA E-Tron for BTM	00838	64876	Self Service Inox Tap Kit for BTM	70008
64935	Stand Right Ramp Stainless Steel for BTM	00672	64949	Trolley Holder Disp-Self for BTM	00839	64954	Sump Kit BK for BTM	70023
72704	Feeder Base Basket Top NA for BTM	00679	64857	Tap Plunger for BTM	00847	72738	Sump Kit BK for BTM	70024
14851	Female Thumbscrew D45 M12 NA for BTM	00681	64858	Plunger O-Ring Ø2 for BTM	00848	64955	Sump Kit BK Ducha for BTM	70025
14829	Male Thumbscrew D45 M8 NA for BTM	00682	64859	Plunger O-Ring Ø4 for BTM	00849	64956	Sump Kit BK Ducha for BTM	70029
64936	Separating Rod D12 for BTM	00683	64860	Tap Handle for BTM	00850			

Electrical Schematics

Model JE-ES-0015-F 39519
Model JE-ES-0015-T 39520
Model JE-ES-0015 39517
Model JE-ES-0015-S 39518
Model JE-ES-0028-F 39522

Model JE-ES-0028-T 39521
Model JE-ES-0045 40531
Model JE-ES-0045-B 40547
Model JE-ES-0028-BB 41965

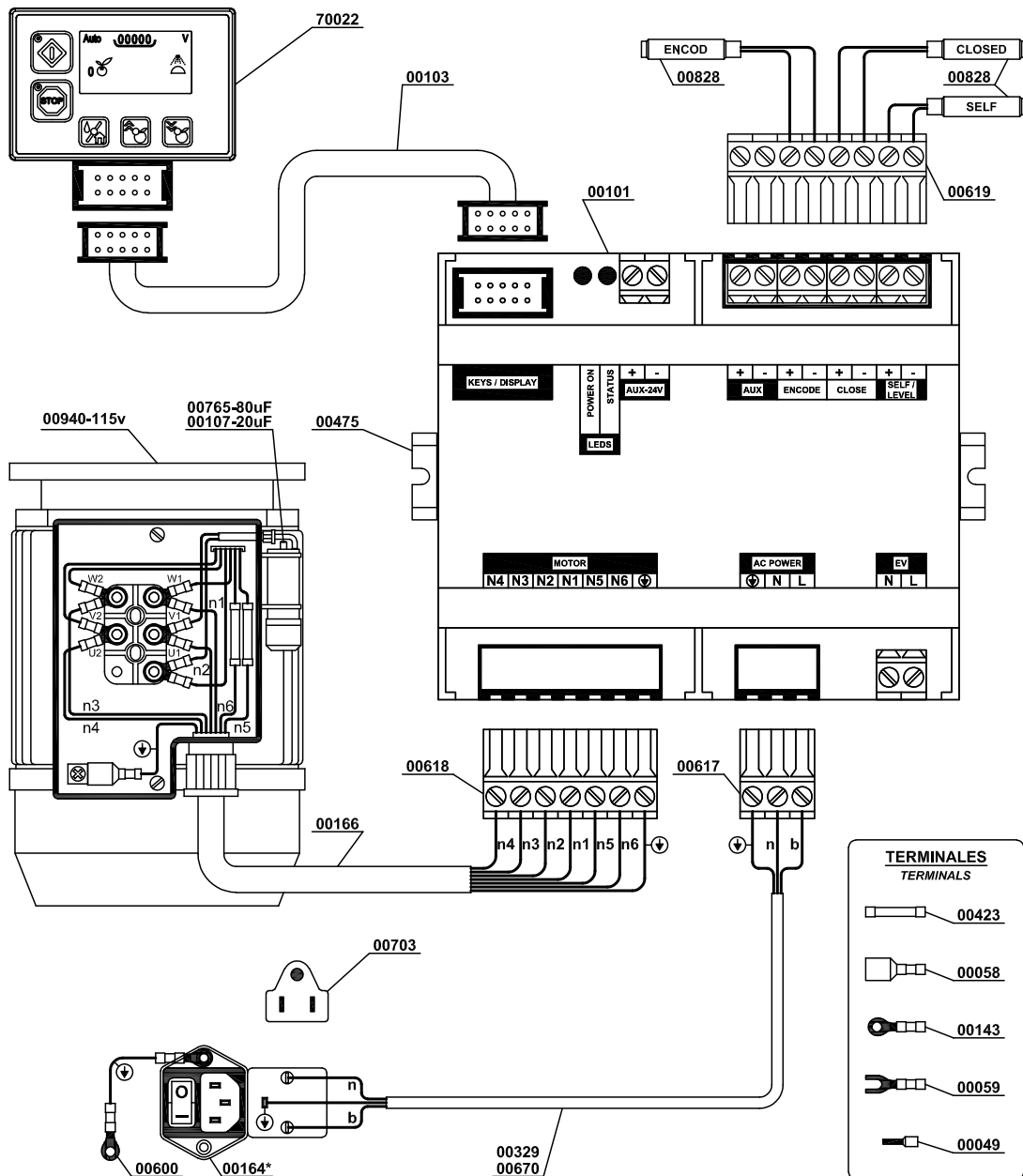

Electrical Schematics

Model JE-ES-0015-F 39519

Model JE-ES-0015-T 39520

Model JE-ES-0015 39517

Model JE-ES-0015-S 39518

Model JE-ES-0028-F 39522

Model JE-ES-0028-T 39521

Model JE-ES-0045 40531

Model JE-ES-0045-B 40547

Model JE-ES-0028-BB 41965

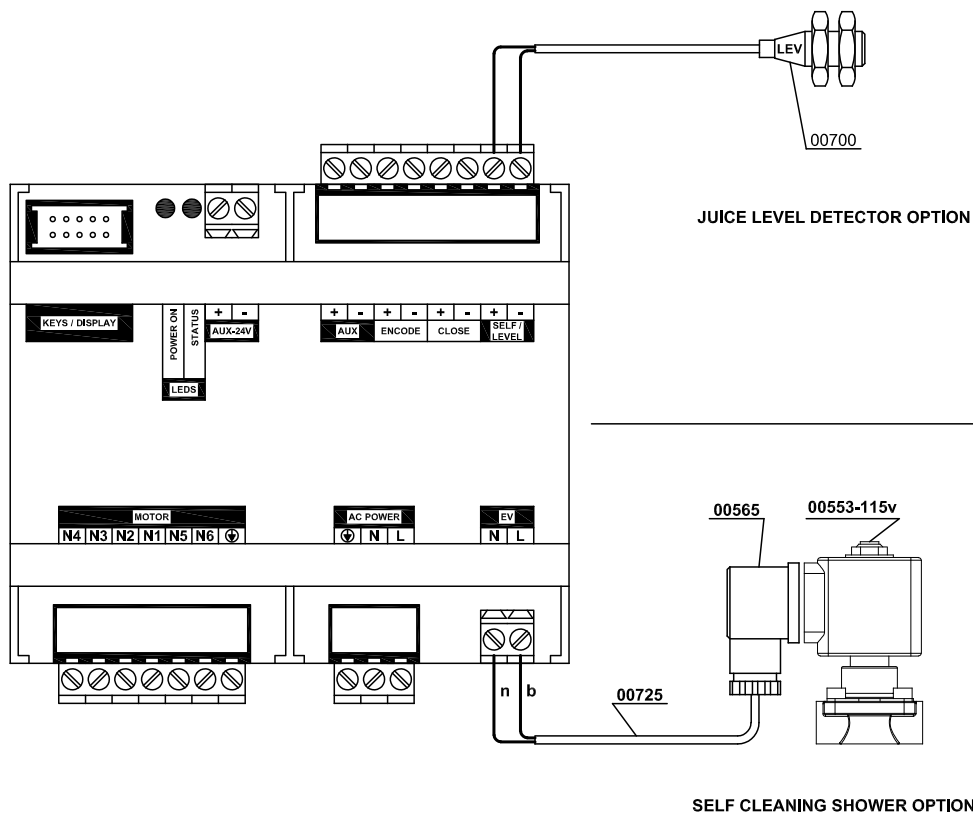

Item No.	Description	Position	Item No.	Description	Position	Item No.	Description	Position
AK905	Solderless Term Insulated	00049	AK913	Internal Wiring	00329	AK920	Internal Wiring	00670
AK906	Solderless Term Insulated	00058	72559	Inductive Proximity Switch	00423	AK921	Capacitive Switch	00700
AK907	Solderless Term Insulated	00059	AK914	Din Rail TS35	00475	72599	Power Cord	00703
AK757	E-Tron Control Module	00101	72581	Solenoid Valve 120VAC-50/60Hz	00553	AK922	Internal Wiring	00725
AK908	E-Tron Internal Wiring	00103	AK915	Coil Connector	00565	AK923	Motor Capacitor	00765
AK909	Motor Capacitor	00107	AK916	Internal Wiring	00600	AF826	Sensor for Cover	00828
AK910	Solderless Term Insulated	00143	AK917	PE-Terminal	00617	AI567	Motor ZEP 0.55KW T-71/90 115V-60Hz	00940
AK911	Power Inlet Connector Filter	00164	AK918	PE-Terminal	00618	AK924	E-Tron Display Kit	70022
AK912	Internal Wiring	00166	AK919	PE-Terminal	00619			



Warranty Registration

Thank you for purchasing an Omcan product. To register your warranty for this product, complete the information below, tear off the card at the perforation and then send to the address specified below. You can also register online by visiting:

Merci d'avoir acheté un produit Omcan. Pour enregistrer votre garantie pour ce produit, complétez les informations ci-dessous, détachez la carte au niveau de la perforation, puis l'envoyer à l'adresse spécifiée ci-dessous. Vous pouvez également vous inscrire en ligne en visitant:

Gracias por comprar un producto Omcan usted. Para registrar su garantía para este producto, complete la información a continuación, cortar la tarjeta en la perforación y luego enviarlo a la dirección indicada a continuación. También puede registrarse en línea en:

<https://omcan.com/warranty-registration/>

For mailing in Canada

Pour postale au Canada

Por correo en Canadá

OMCAN

PRODUCT WARRANTY REGISTRATION

3115 Pepper Mill Court,

Mississauga, Ontario

Canada, L5L 4X5

For mailing in the US

Pour diffusion aux États-Unis

Por correo en los EE.UU.

OMCAN

PRODUCT WARRANTY REGISTRATION

4450 Witmer Industrial Estates, Unit 4,

Niagara Falls, New York

USA, 14305

or email to: service@omcan.com



Purchaser's Information

Name: _____

Address: _____

City: _____ Province or State: _____ Postal or Zip: _____

Country: _____

Dealer from which Purchased: _____

Dealer City: _____ Dealer Province or State: _____

Invoice: _____

Model Name: _____ Model Number: _____

Machine Description: _____

Date of Purchase (MM/DD/YYYY): _____

Would you like to extend the warranty? Yes No

Company Name: _____

Telephone: _____

Email Address: _____

Type of Company:

Restaurant Bakery Deli

Butcher Supermarket Caterer

Institution (specify): _____

Other (specify): _____

Serial Number: _____

Date of Installation (MM/DD/YYYY): _____

Thank you for choosing Omcan | Merci d'avoir choisi Omcan | Gracias por elegir Omcan



Since 1951 Omcan has grown to become a leading distributor of equipment and supplies to the North American food service industry. Our success over these many years can be attributed to our commitment to strengthen and develop new and existing relationships with our valued customers and manufacturers. Today with partners in North America, Europe, Asia and South America, we continually work to improve and grow the company. We strive to offer customers exceptional value through our qualified local sales and service representatives who provide convenient access to over 6,500 globally sourced products.

Depuis 1951 Omcan a grandi pour devenir un des “leaders” de la distribution des équipements et matériel pour l’industrie des services alimentaires en Amérique du Nord. Notre succès au cours de ces nombreuses années peut être attribué à notre engagement à renforcer et à développer de nouvelles et existantes relations avec nos clients et les fabricants de valeur. Aujourd’hui avec des partenaires en Amérique du Nord, Europe, Asie et Amérique du Sud, nous travaillons continuellement à améliorer et développer l’entreprise. Nous nous efforçons d’offrir à nos clients une valeur exceptionnelle grâce à nos ventes locales qualifiées et des représentants de service qui offrent un accès facile à plus de 6500 produits provenant du monde entier.

Desde 1951 Omcan ha crecido hasta convertirse en un líder en la distribución de equipos y suministros de alimentos en América del Norte industria de servicios. Nuestro éxito en estos años se puede atribuir a nuestro compromiso de fortalecer y desarrollar nuevas relaciones existentes con nuestros valiosos clientes y fabricantes. Hoy con socios de América del Norte, Europa, Asia y América del Sur, que trabajan continuamente para mejorar y crecer la empresa. Nos esforzamos por ofrecer a nuestros clientes valor excepcional a través de nuestro local de ventas y representantes de los servicios que proporcionan un fácil acceso a más de 6,500 productos con origen a nivel mundial.

