



USER'S MANUAL

HC

Use and care manual for HC refrigerant gas units.



INCLUDED LINES: LX-R / LX-F

Carefully read this manual before using unit.

Contents

1	IMPORTANT SAFETY INFORMATION	3
	1.1 Safety precautions	3
2	UNIT SERIAL NUMBER	6
	2.1 Locating the labels	6
	2.2 Ownership	7
3	INSTALLATION	7
	3.1 Accessory installation	8
	3.2 Electrical connection	12
	3.3 Turning on the unit	14
4	HOW TO USE THIS UNIT	14
	4.1 Storing product inside unit	14
	4.2 Temperature control	16
	4.3 Lighting	19
	4.4 Hinged door	20
	4.5 Self-closing system for hinged door	21
	4.6 Sliding doors	21
	4.7 Self-closing system for sliding doors	22
5	GENERAL MAINTENANCE	22
	5.1 General cleaning	23
	5.2 Condenser cleaning	23
	5.3 Evaporator defrosting	24
	5.4 Technical maintenance	25
6	UNIT'S FINAL DISPOSITION	25
7	TROUBLESHOOTING GUIDE	26
8	TECHNICAL SUPPORT	30

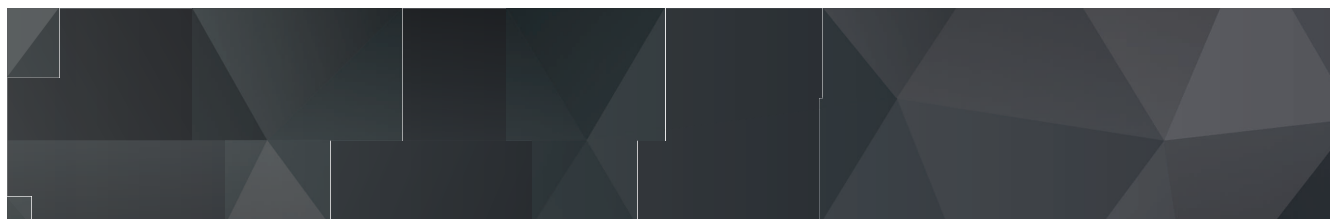

1. IMPORTANT SAFETY INFORMATION

READ ALL INSTRUCTIONS BEFORE USING

WARNING!

Use this unit only for the purpose that it was made for as described in this manual. Proper installation, care and maintenance are essential for proper operation and maximum energy efficiency.

In the event you find a problem not described in this manual, do not attempt to solve it by yourself; call MVP's Technical Support Services for assistance.

IMPORTANT: we strongly recommend you ask for assistance from our Technical Support Services or from our qualified technicians for any failure, problem or malfunction of this unit.

1.1 SAFETY PRECAUTIONS

- Before using, this unit must be installed and placed following the instructions contained in this manual. Save these instructions for future reference.
- Do not allow individuals to climb, stand on or hang from the outer portion of the unit, on the shelves or inside the cabinet. This may cause the unit to tip over and damage the device or cause serious injuries or death.
- Do not touch the inner surfaces of the unit when hands are damp or wet. Skin may adhere to these extremely cold surfaces.
- Do not store or use solvents, flammable vapors or liquids in the vicinity of this or any other electrical devices.
- Unplug the unit before cleaning or performing any kind of repair.
- To avoid stains wipe up any spills inside the cabinet immediately.
- If the unit is equipped with power switches, turn the unit on and off through these buttons. If the unit does not have them, shut down directly from the plug, but never pull the cable to do so. For any maintenance you must disconnect the unit from the electrical supply.
- Children must be supervised to make sure they do not play with the unit.
- This unit is not designed to be used by people with physical or intellectual disabilities, children or people with no experience and knowledge of use, unless they are supervised by an adult who has properly read and understood this manual and looks out for their safety.
- Do not use or operate this device if its use has been excessive, or it has been misused, altered or modified from manufacturer's original specifications.

- 
- Be extremely careful when closing doors, keeping fingers out of the clearances between the doors and cabinet, to prevent injury.
 - This unit contains a charge of refrigerant at a pressure determined by the type of refrigerant used and the internal volume. The installation and welding of the piping should be treated by a service technician authorized by MVP who is properly trained in the use and management of refrigerants.
 - Never stack two or more units; leveling feet are not designed for this purpose, and doing so compromises use safety. Stacking of one unit, only, on top of the same model is approved if using pods, skids or pallets, and supported by the cabinet corners only.
 - Refrigeration system on this unit must not be damaged or manipulated by untrained personnel.

AVOID RISKS: if power cord or other electronic components are damaged, only the manufacturer or an authorized technician may repair it to avoid danger, so as to minimize the risk of possible ignition due to incorrect parts or improper service.

IMPORTANT: do not to use a cutter knife or blade for unit handling. Inappropriate use may scratch or cut off components.



PRECAUTION: do not store explosive substances, such as spray cans with flammable propellant, inside unit.



PRECAUTION: this unit uses highly flammable HC refrigerant. Do not perforate cooling system tubing. This may cause fire or explosion.



WARNING: do not obstruct unit venting grills. It is important to maintain adequate air flow.



WARNING: do not use mechanical devices or other means to speed up deicing process, other than those recommended by the manufacturer.



WARNING: do not damage cooling circuit.



WARNING: do not use electrical equipment inside unit's storage compartment except for types recommended by the manufacturer.



WARNING: in order to reduce flammability danger, unit installation must be performed by qualified personnel only.



DANGER: fire or explosion risk. This unit uses highly flammable HC refrigerant. Any unit repairs must be performed by qualified personnel.



IMPORTANT

MVP reserves the right to perform product improvements. Design and specifications are subject to change without notice

2. UNIT SERIAL NUMBER

2.1 LOCATING THE LABELS

In order to give you the best service, it is necessary to locate the serial number as shown below:

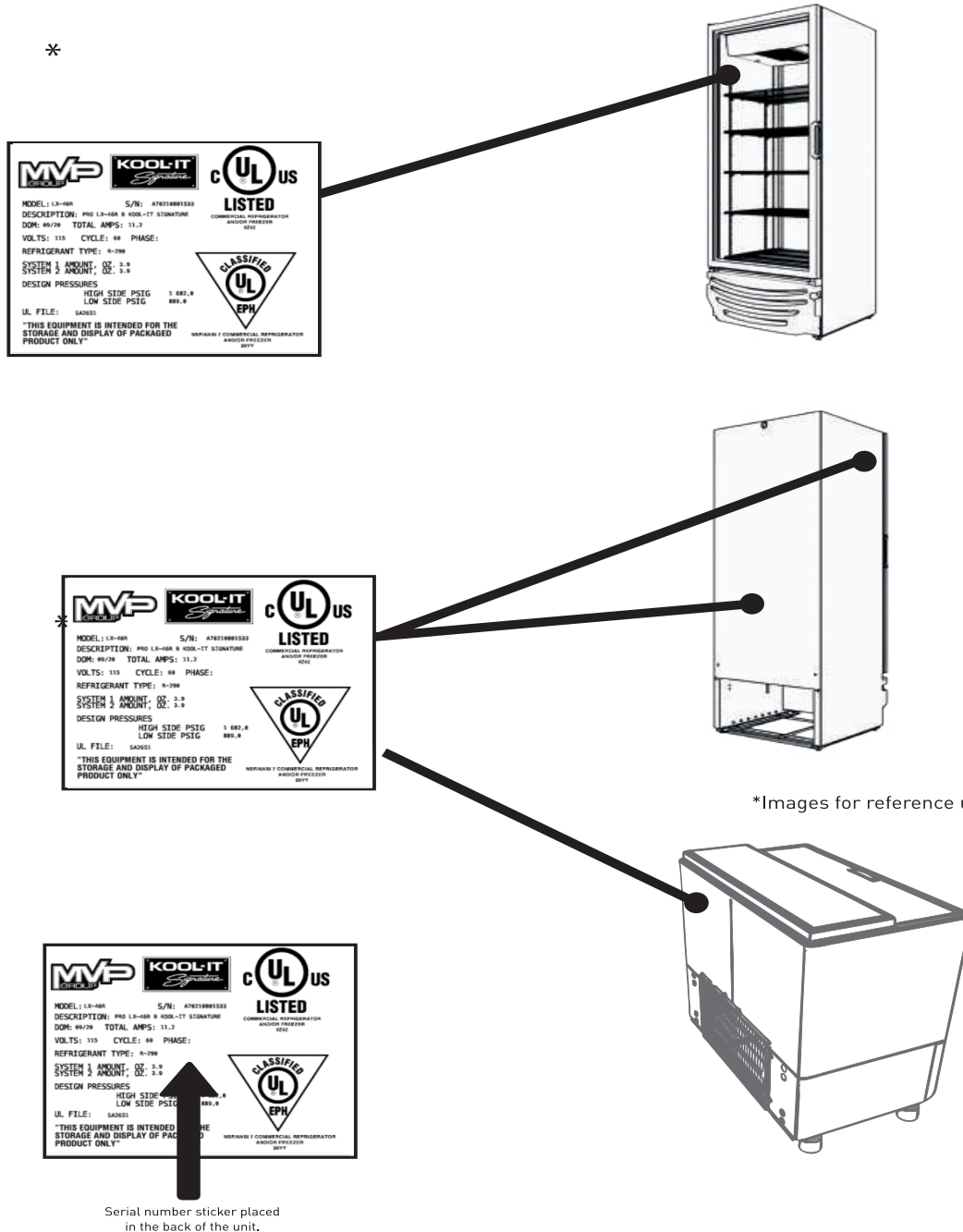

How to read a serial number

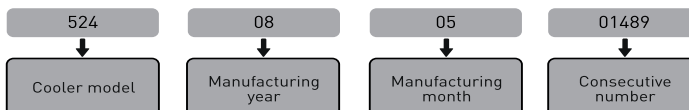

Climate classification

MVP coolers are designed to work according to certain ambient temperatures. Check your cooler's classification on the corresponding serial number label (see page 5). Cooler operation is not recommended under temperatures above indicated as this may create high energy consumption levels.

See table below to identify your cooler's operation temperature.

Climate class	Temperature	Relative humidity
0	20°C	50%
1	16°C	80%
2	22°C	65%
3	25°C	60%
4	30°C	55%
6	27°C	70%
5	40°C	40%
7	35°C	75%
8	23.9°C	55%

NOTE: climate class is specified in ISO 23953-2.

2.2 OWNERSHIP

Before you start to install your MVP unit, carefully inspect it for freight damage. If damage is discovered, immediately file a claim with the delivery freight carrier.

MVP is not responsible for damage incurred during shipment.

3. INSTALLATION

- Install this unit away from direct sunlight.
- Do not install this unit outdoors.
- This unit must not be used or stored where ambient temperature is under 14°F or greater than 140°F or where relative humidity is greater than 90%.
- Never install equipment close to heat sources; otherwise, unit may consume more energy or function incorrectly.
- Do not introduce objects that are hot or warmer than ambient temperature inside unit..
- Never obstruct or place objects along front grill which may obstruct free air flow; this may cause inefficient unit operation and will increase the energy consumption.

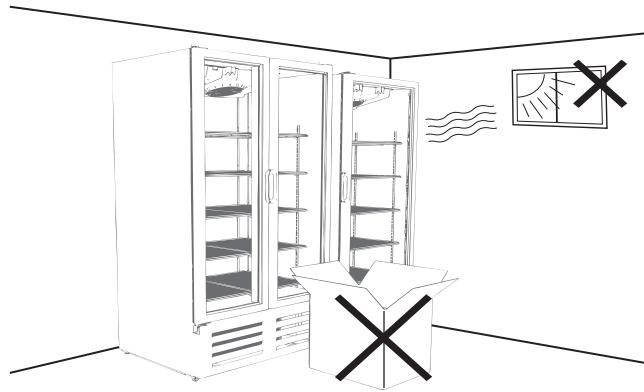

- Never place objects over the unit. Consider that the cabinet's structure has been constructed mainly of laminated sheet metal and polyethylene foam that may easily bend or deform when hit, and it may even deform over time due to placement of TV, microwave oven and other objects.
- For optimal performance, unit separation on back and sides must be at a minimum distance of 4 inches (10 cm) with respect to walls or other nearby objects.

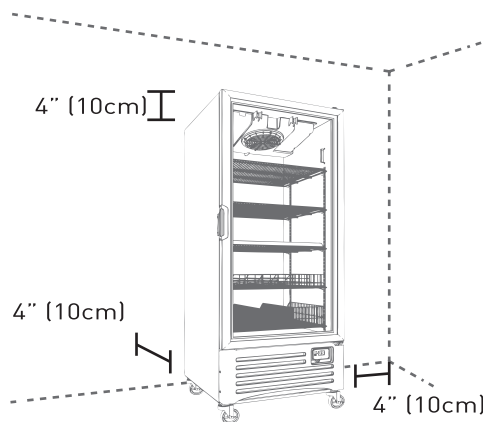

3.1 ACCESSORY INSTALLATION

Before turning the unit on or connecting to power supply, make sure you use the installation kit, such as wall separators, level supports or other accessories.

Depending on your unit's model, you may have some of the following accessories:

Accessories



leveling skid

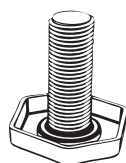

leveling screw

Used to provide support and adequate inclination for door closure.

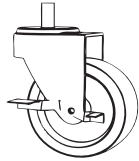

caster

Some models have optional casters for easy mobility inside the establishment. If this is the case, casters are factory-installed, and it is only necessary to remove transport pods.

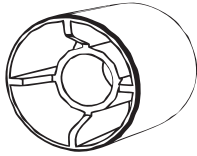

wall spacer

This accessory is designed to provide adequate separation between unit back and wall.

Tool to be used



safety shoes



gloves



safety goggles

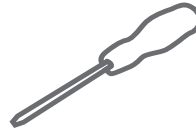

Phillips or flat screwdriver



pliers

Leveling skid / leveling screw

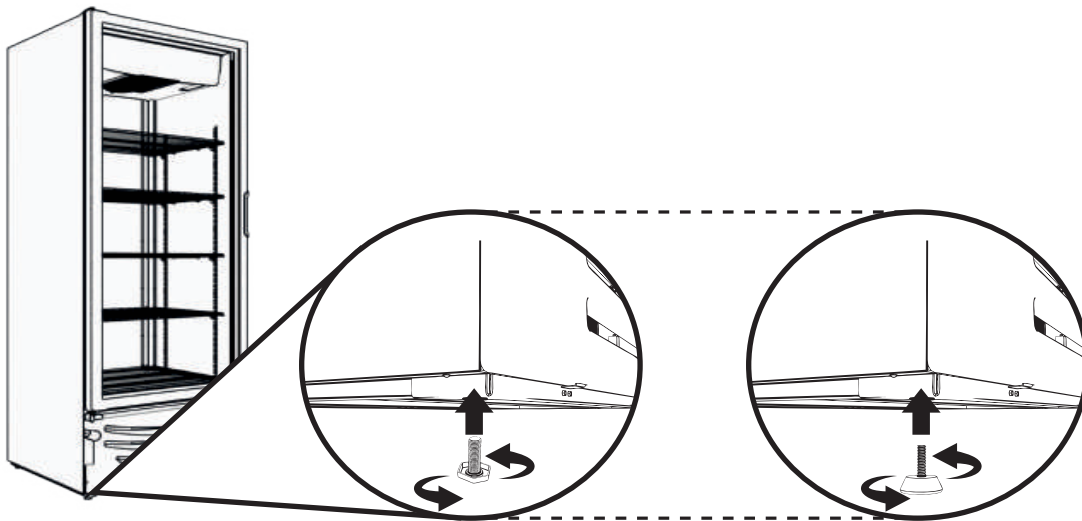

Casters

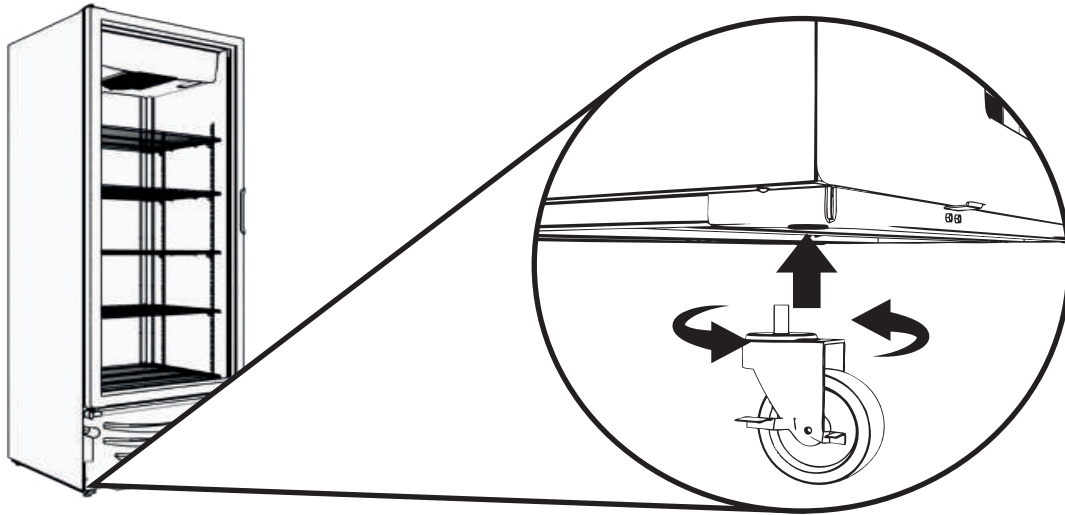

Wall spacer

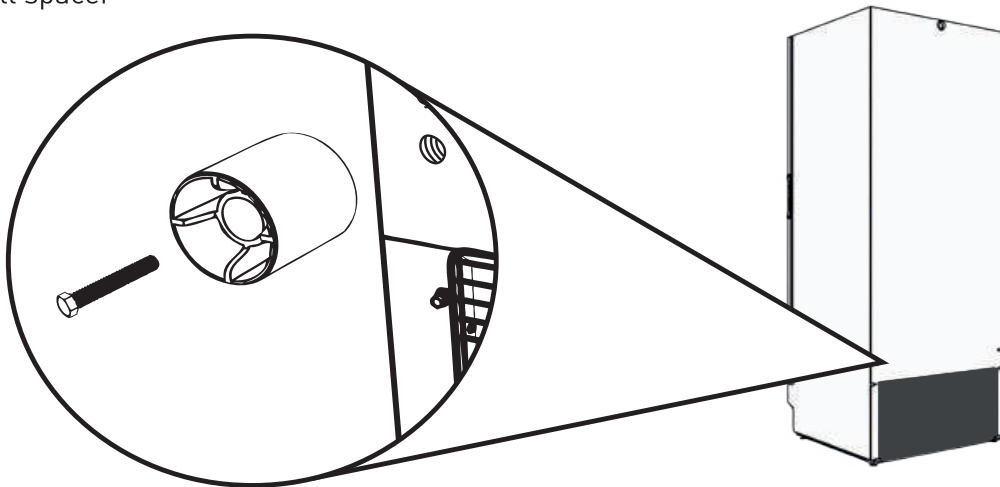

Instructions

1. Use a ¼ "screwdriver
2. Insert the hexagonal screw through the wall spacer
3. Place the hexagonal screw on the insert nuts positioned on the backrest of the unit.
4. Screw the wall spacer.

Shelves



Floor shelf



Level shelf

These accessories must be used to place products inside the unit. They are designed to optimize unit's internal space.

Depending on your unit's model, it may have different types of shelves. These are some types:

Floor Shelves



Type A



Type B



Type C

Observe that these shelves have supports to place them over unit's floor, as well as enough rods to support product load.

Level shelves



Type E



Type F



Type G

Shelves must have an adequate orientation and position, never to be forced or exert pressure on the unit walls or any other accessory.

All shelves must be firmly supported on all four corners with provided accessories:



Metallic clips

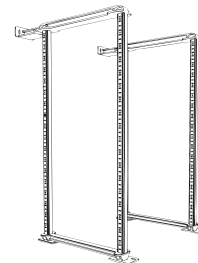

Multilevel frames

Make sure the shelf and the product allow the door to close completely.

IMPORTANT: shelves must have an adequate orientation and position, never to be forced or exert pressure on unit walls or any other accessory.

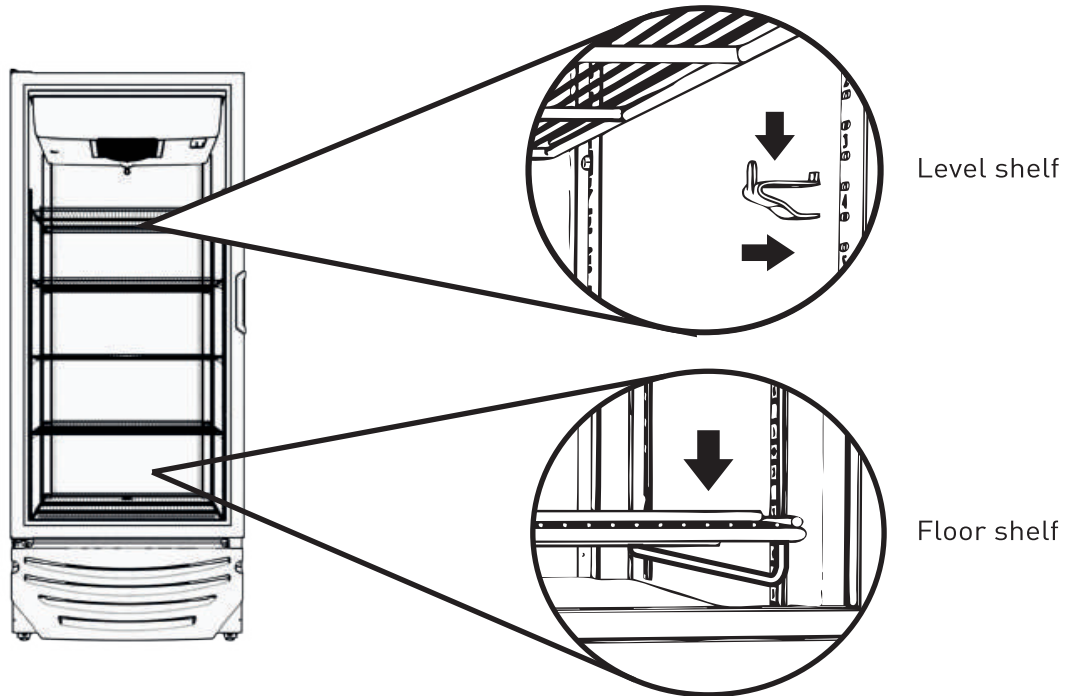

Gravity Organicer (optional*)

The Gravity organicer system allows placing shelves and product at an angle; thus, bottles will always slide to the front.

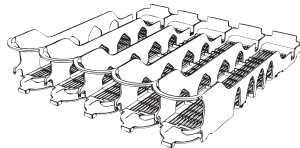

Baskets (optional*)

Unit may also have plastic or metal baskets to exhibit product.

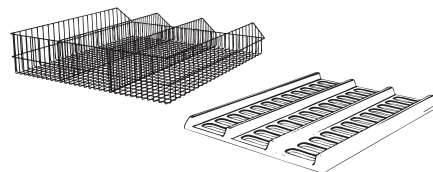

3.2 ELECTRICAL CONECTION

⚠ WARNING

Electric shock risk

- Connect to a three-pin outlet
- Do not remove outlet ground pin
- Do not use power adapters
- Do not use extension cords
- If failure occurs when following these instructions, it may cause fire or electric shock

MVP units with HC refrigerants (R290 / R600a) are designed to operate under a specific electric voltage. Check unit's serial label to make sure that the electrical classification is adequate for installation (see page 5).

IMPORTANT: ground connection is a protection system for equipment connected to electrical network. It is used in electrical installations to avoid current pass-through to user due to an isolation failure of active conductors.

This unit must be connected to physical ground. In case a short circuit occurs, ground connection reduces the risk of electrical shock.

- Unit is equipped with a power cord with a ground cable with a physical ground connection plug. Plug must be connected to an adequately-installed outlet and ground connected; if you don't have this type of plug, it is your responsibility and obligation to have it installed.

- Please contact a certified electrician or a certified technician if you have questions about ground connections.

- Never use extension cords, as that action will void the warranty.

- Under no circumstances cut off or remove the third ground connection pin from power cord. Do not use an adapter; if this recommendation is not followed, it may cause burns or death to user due to electrical shock.

- For optimal operation, it is recommended to have this equipment connected to a dedicated circuit outlet that is for unit use only.

- Connect plug firmly to electrical outlet making sure it is inserted all the way in.

- Never unplug your refrigerator by pulling on the power cord. Always grip plug firmly and pull straight out from the outlet.

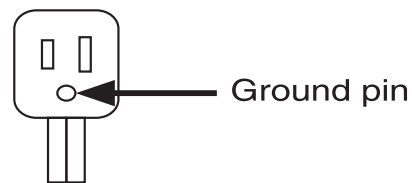
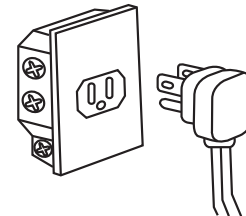

Power cord

Unit is equipped with a polarized power cord, with ground connection. Do not attempt to eliminate ground connection or use two-terminal adapters.

AVOID RISKS: if the power cord or other electronic components are damaged, only the manufacturer or authorized technician may repair them to avoid danger, so as to minimize the risk of possible ignition due to incorrect parts or improper service.

NEVER USE AN ADAPTER PLUG! Because of potential safety hazards under certain conditions, we strongly recommend against the use of an adapter plug.

The incoming power source to the cabinet including any adapters used must have the adequate power available and must be properly grounded. Only adapters listed with UL should be used.

3.3 TURNING ON THE UNIT



After having transported and installed the unit, let it stand for at least twelve hours to allow compressor oil to fully settle.

Once the installing instructions have been followed, connect the unit per electrical specifications indicated on serial number label (placed inside cabinet).

For your own safety, avoid touching the device with wet or damp hands or feet. You should not handle unit when barefooted.

4. HOW TO USE THIS UNIT

4.1 STORING PRODUCT INSIDE COOLER

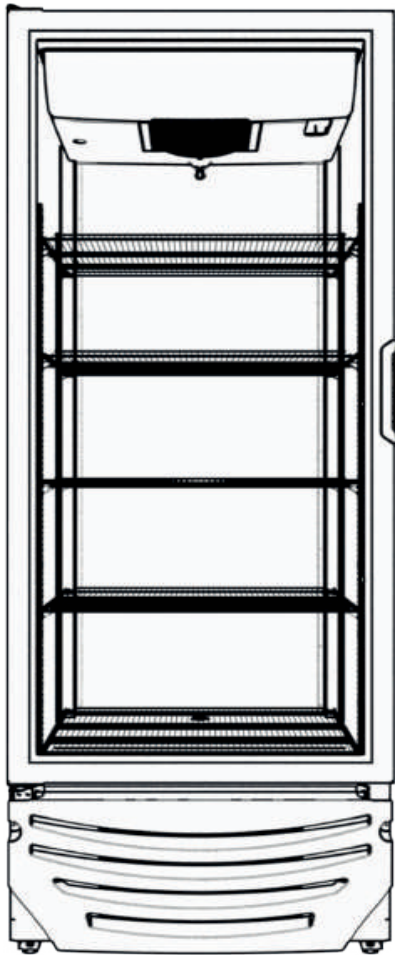

- If a floor shelf is included (Type A, B, C, D), place it directly inside unit, and right after that, place shelves (Type E, F, G), using metallic clips (make sure they are aligned at the same height). If a floor shelf is not included use clips to place a shelf (see pages 9 and 10).
- If the unit has a plastic rack included, it includes supports for each grill, without using metal clip.
- If the unit has been turned off and it is necessary to turn it on, wait for at least one hour to cool the interior of the unit before introducing product.
- When the unit is filled up, arrange and order product inside; do not throw or drop product when placing it inside as that action will damage interiors and shelves.

Airflow inside cabinet is priority for the unit, thus make sure that:

- Product does not exert pressure on internal walls and it does not go beyond perimeter of grill limits.
- Avoid introducing containers inside closed boxes, such as carton board, trays, bags or plastic covers.
- If your unit has a bin and fan avoid placing product and other objects against, or in a way that obstructs, fan air outlets.



IMPORTANT: some models are designed to cool products (i.e. beer), below 0°C. Do not use this type of unit for other products that may be quality-affected due to these low temperatures. Some products freeze when subjected to these temperatures and the containers may explode. If product containers are made of glass, they may cause cuts and serious wounds to you; thus, always follow recommendations and instructions from your supplier. Do not introduce unauthorized containers or product or, ask the Service Center for further details.

IMPORTANT: horizontal shelf maximum load must not exceed equivalent weight of three can trays of 12oz (355ml)..

Design climate condition

Condition	Temperature	Relative Humidity
A	77°F	60%
B	75°F	45%
C	90°F	65%
D	105°F	75%

4.2 TEMPERATURE CONTROL

All MVP temperature controls are electronic and are previously configured by the manufacturer. Thanks to this technology, neither height nor exterior temperature affect the interior environment, thus, no adjustments are necessary.

Your unit may include one of these controls:

- CIF: Intelligent Control Function
- EMS: Energy Management System
- ETC1H: Electronic Controller
- LAE: Digital Control for Refrigerated Cabinets
- ERC: Electronic Refrigeration Controller.

The temperature control display is usually located inside the unit, or on the plastic front grill.

In the case of ETC1H control, it is located on the condenser unit. It is protected by the front plastic grill. In smaller units, ETC1H is located on the back of unit. It does not have a display.

If your unit has an Intelligent Control Function (CIF), follow the instructions attached to unit for further detail.

Each CIF has its own cooling configuration. It may also include energy savings modes and it may transmit information to your suppliers. Energy savings modes may be activated with the display button or automatically when the unit is not in use.

In case of units without door, although some versions have CIF, they don't include the savings mode due to lack of a door; however, you must use the night curtain just before closing your business to reduce energy consumption and to allow compressors to rest.

If the unit includes an EMS controller, it will also be preconfigured. It analyzes temperatures inside and outside the unit for better cooling of product. Temperatures and alarms are shown on integrated display.

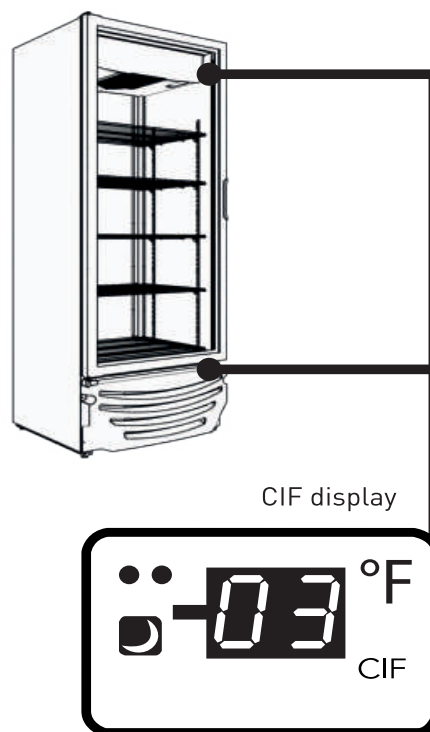

The ERC controller is preconfigured and allows the user to set the right temperature for the product. It includes inner temperature sensor and also has sensors for the refrigeration and lighting system that allow a better performance.

The LAE control is preconfigured, allowing user to select an adequate temperature for different products. Alarms are shown on the display. It also includes an automatic deicing mode, manual deicing, and lighting control.

*IMPORTANT: if the unit has a temperature control issue or, if failure alarms occur on CIF, EMS, LAE or ERC displays, never attempt to make control adjustments; please call the **MVP** Technical Services Department. You will be assisted by experienced and authorized personnel.*

The ETC1H control in some models is also preconfigured by the manufacturer to maintain product temperature. It does not include a display that shows temperature or alarms. If you notice malfunctioning, please notify the MVP USA Technical Services Department.

CIF

The Intelligent Control Function is designed by Imbera to satisfy market cooling needs, achieving maximum energy efficiency.

There are many CIF models to provide various solutions for multiple cooling needs for each product.

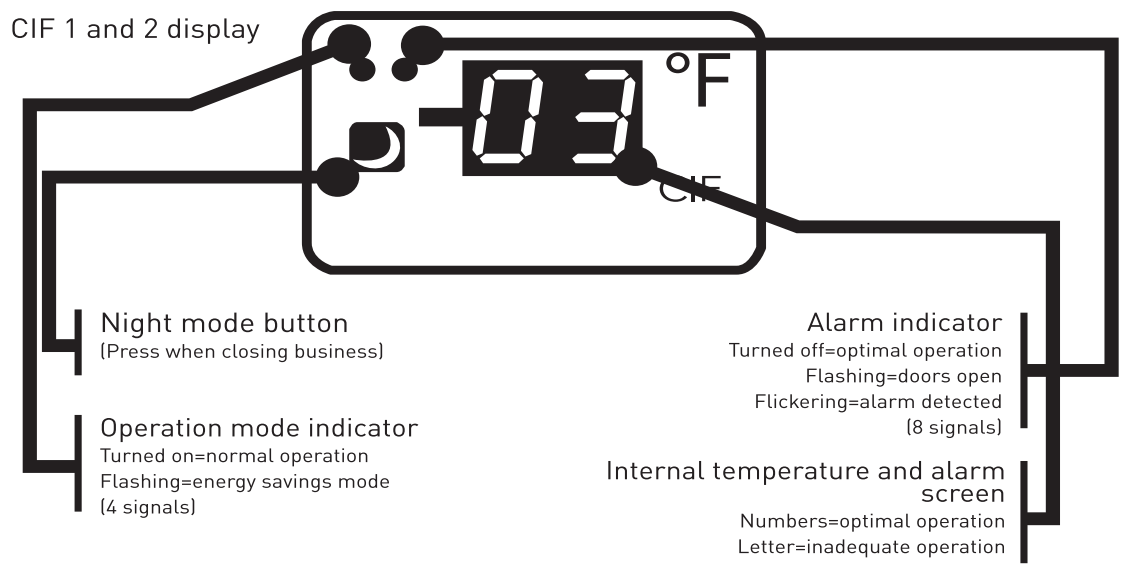

CIF NOVO display

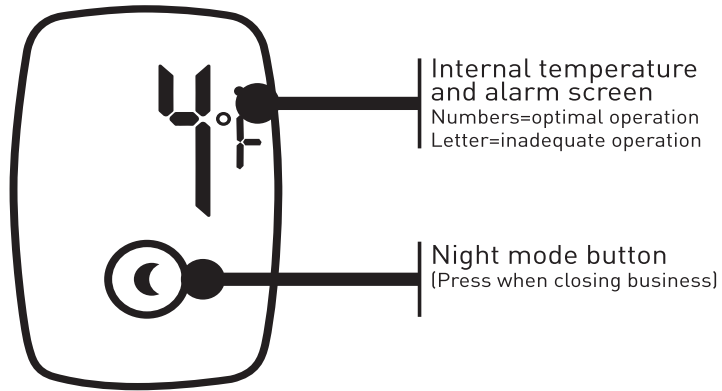

CIF EVO display

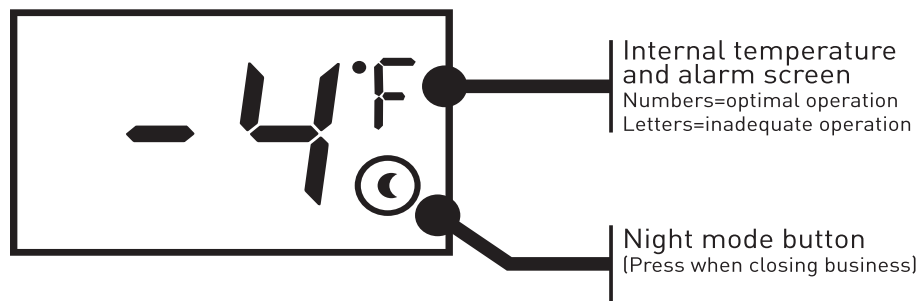

EMS

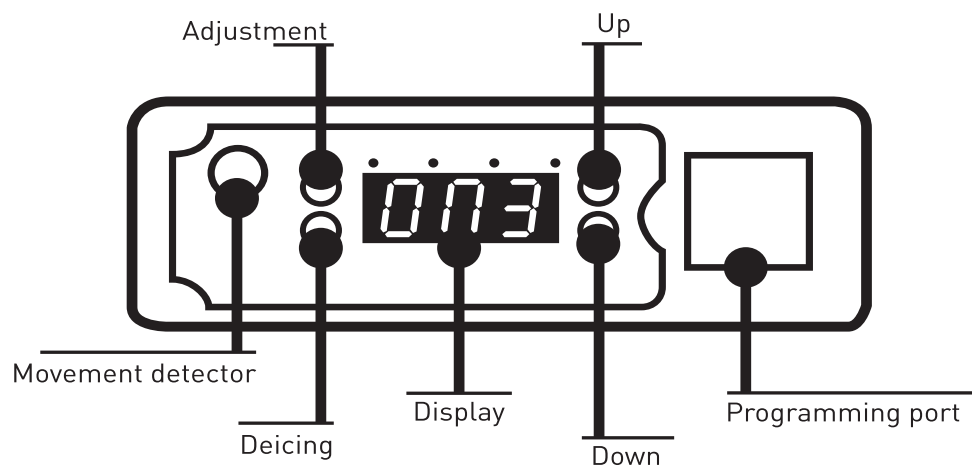

LAE

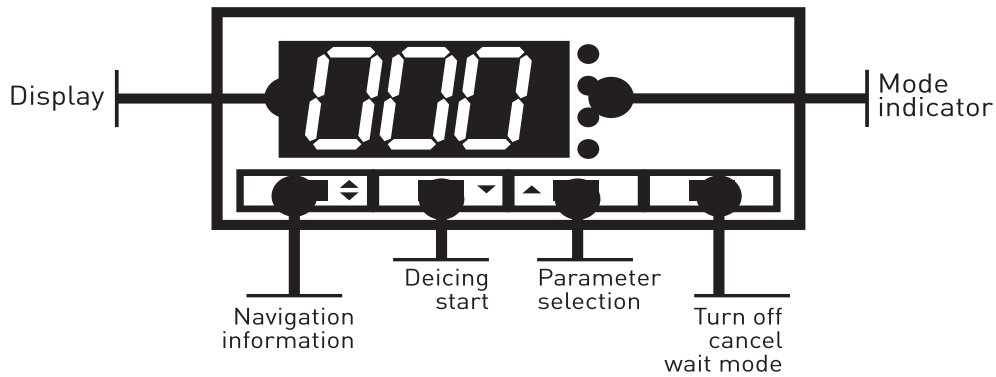

ETC1H

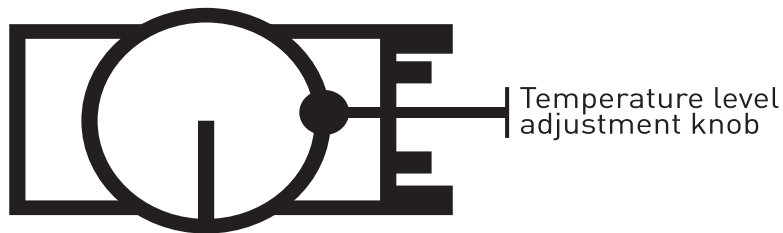

ERC

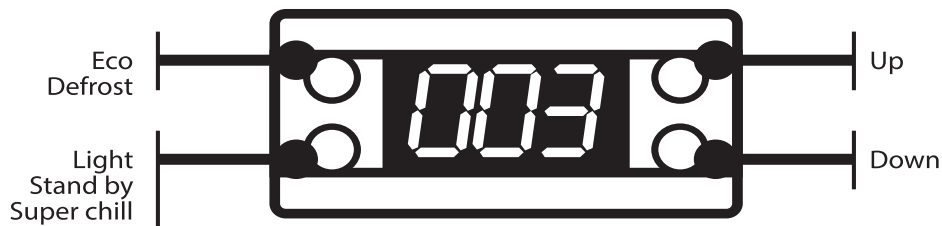

4.3 LIGHTING

Consider that this unit has been designed with the intention to exhibit products to encourage your and your supplier's sales. For best results, lighting must be turned on during sale hours.

Our LED lighting technology allows an improved electric efficiency, reducing and providing more operation years with regard to lighting. LED lighting is located around the door perimeter, on the internal cabinet upper portion, or around the perimeter of the internal cabinet.

Your unit may include a switch that allows you to turn off lighting manually. Use it only when your business is closed. During sale schedule, this lighting technology represents a minimum percentage of the unit's total energy consumption.

If the unit includes an Intelligent Control Function (CIF), lighting will be tuned off automatically in savings mode. You don't have to worry about this, each control will turn lighting off according to unit characteristics and the products contained in it. Just open the door to exit savings mode.

IMPORTANT: if you notice any lighting malfunction, please contact the MVP Service Department.

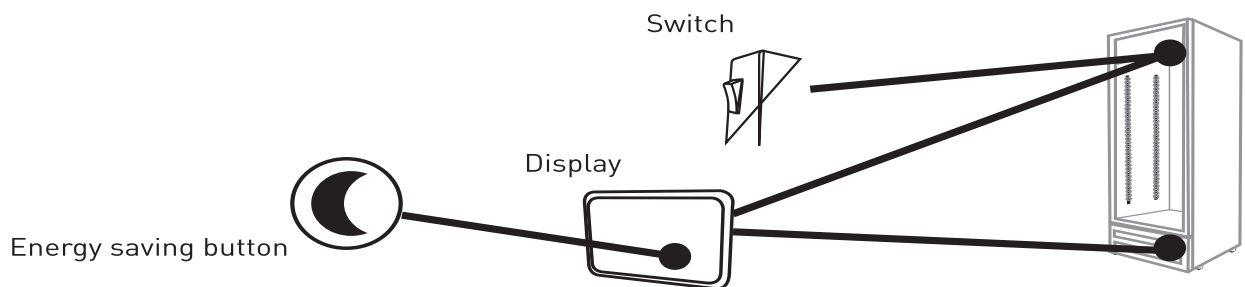

4.4 HINGED DOOR

Unit's door is designed to thermally isolate the refrigerated product from the environment. If it gets fractured or broken, do not attempt to repair it; call the MVP USA Service Department.

Door hinges and supports have been designed for an adequate turning radius and a proper seal separation distance. If for any reason you need to replace or adjust, request support from the MVP USA Service Department.

If the unit includes reversible doors and requires a change at the opening, allow this task to be performed by a knowledgeable authorized technician with regard to the self-closing system and electrical installation.

Keep fingers out of risk areas such as door frame and hinges, always use the handle.

Pay special attention when closing doors especially when children are nearby.

Door opening must be free from objects or obstacles as they might fall down or slide down causing injuries or wounds to users.

4.5 SELF-CLOSING SYSTEM FOR HINGED DOOR

Door may be equipped with a self-closing system that keeps door from being left open carelessly, forcing it to close by an internal spring part of its mechanism. If you notice that it lacks sufficient force to fully close or it closes with too much force such that damage to the door or refrigerated product may be at risk, call the MVP Service Department.

The unit may include a self-closing system with lock, with two user modes:

1. Automatic closure: thanks to an internal spring in the mechanism, the system closes the door automatically when it is positioned from 20° to 90° in aperture.
2. Reloading: if aperture is greater than 90°, the door lock will be activated and door will remain open at 90°. Thus, you can conveniently reload unit. To release lock, you simply push the door again from 90° to 75° to return to mode 1.

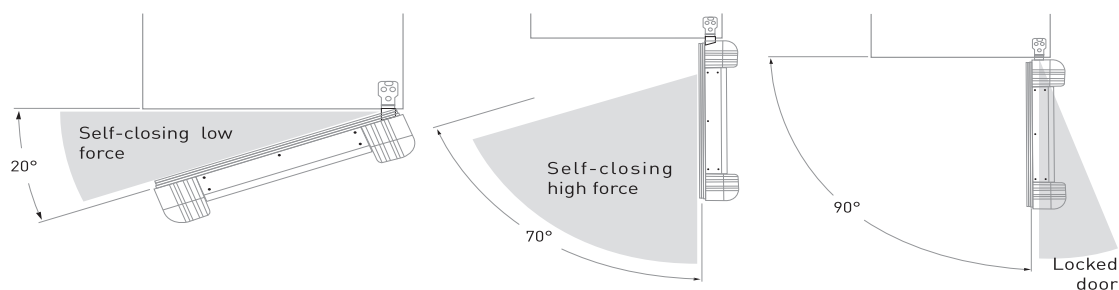

4.6 SLIDING DOOR

Just as with hinged doors, sliding doors are designed to provide optimal thermal isolation of refrigerated products, making product display more efficient at the point of sale. If the sliding door is damaged, do not attempt repairing it yourself. Call the MVP USA Service Department.

Sliding doors are supported by a set of rails, allowing door opening with minimal force, providing access to product.

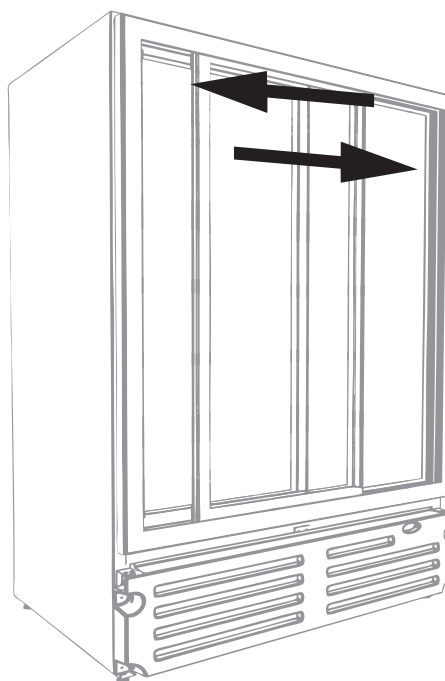

4.7 SELF-CLOSING SYSTEM FOR SLIDING DOOR

The unit may be equipped with an integrated self-closing sliding door system inside the frame, which prevents doors from remaining open carelessly, forcing them to close by an internal spring part of its mechanism. If you notice that it lacks sufficient force to fully close or it closes with too much difficulty, such that it could damage the door or refrigerated product may be at risk, call the **MVP** Service Department.

To open doors, just slide from left to right on the opposite side where they are located.

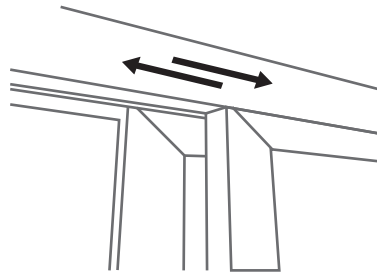

To refill unit, open left door and turn right door lock. Thus, you may keep doors open temporarily, while you fill the unit with product to be refrigerated.

5. GENERAL MAINTENANCE

IMPORTANT: disconnect the unit from wall outlet before you perform any maintenance or cleaning task.

IMPORTANT: do not perform any cleaning task with water hose or jet wash as it may cause damage to electrical components and cause electric shock.

It is preferable to perform cleaning and maintenance tasks using safety work gloves.

With a moistened cloth, clean glass solid and glass door internal and external surfaces at least once per week accordingly.

At least every three months, clean the door's seal, check it for perfect condition, and check whether it makes contact with frame inside cabinet.

With a moistened cloth, clean glass solid door internal and external surfaces at least once per week.

At least once per month, clean sliding door rails and check for perfect conditions for adequate door slide

5.1 GENERAL CLEANING

Cleaning the unit regularly prevents deterioration and reduces malfunctioning that may alter product preservation.

Clean with a piece of cloth only, warm water and neutral soap. Dry surfaces using a soft cloth or rag.

Avoid cleaning surfaces with water hose or jet wash.

Do not use solvent or abrasive products for cleaning tasks as they may damage surface finish.

Do not use sharp points to remove excessive dirt; use brush if required.

Use a broom or mop to clean area under unit. Avoid splattering water directly under unit's internal front area.

Do not use cleansers, detergents, degreasers, sanitizers or bleaching agents that contain chlorides or phosphates on stainless steel.



5.2 CONDENSER CLEANING

Condenser must be cleaned once per month or when required to prevent dirt from reducing cooling system efficiency.

To clean condenser, it is necessary to remove the unit's front grill.

Remove dust, lint and trash with soft bristle brush or broom.

In grease-based locations, such as kitchens and/or food cooking areas, accumulated grease or grime must be cleaned off with water and degreasing agents.

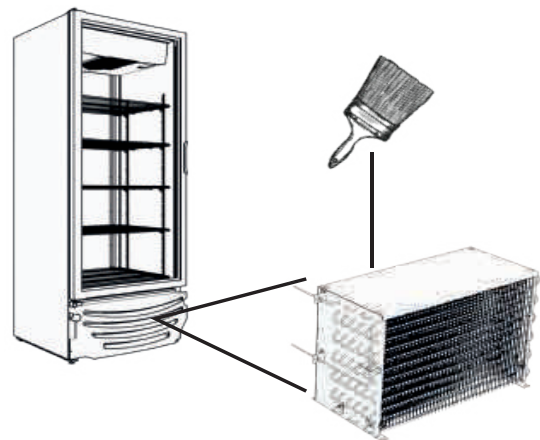

Vacuum Valve

To clean the vacuum valve, follow the next steps:

- 1) Remove the vacuum valve cover.
- 2) Turn and pull the vacuum valve until you remove it.

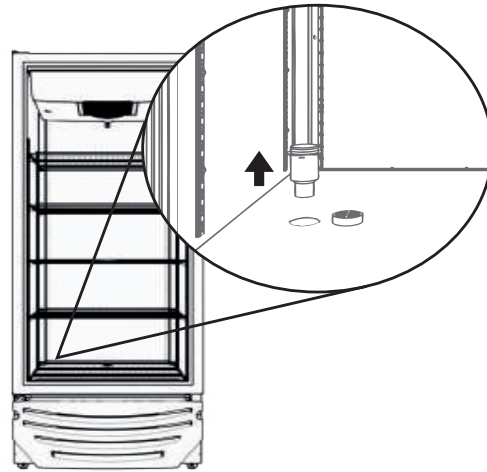

5.4 TECHNICAL MAINTENANCE

If your MVP unit requires major maintenance due to refrigeration, electric or lighting system failure, please contact the MVP USA Service Department.

All repairs must be performed by an authorized technician. Attempts to repair this unit by inexperienced personnel or yourself may create malfunctions, damage to unit or to yourself. Such attempts will be considered to automatically void the warranty.

Request and make sure original spare parts are used with the same characteristics to guarantee the unit's optimal operation.

Before calling the MVP USA Service Department check the Troubleshooting Guides included in this manual.

6. UNIT'S FINAL DISPOSITION

CAUTION: Risk of fire or explosion. Dispose of property in accordance with Federal or local regulations. Flammable refrigerant used.

This unit's packaging is manufactured with materials that may be recycled. When disposing of packaging, separate materials to be recycled.

This unit uses refrigerant gas that does not damage the ozone layer and it has a low greenhouse effect. These gases are flammable.

This unit contains cyclopentane foam as isolating agent, components that contain oil and electrical/electronic components. Do not discard unit together with household waste; find a collection center approved by local legislation.

Before discarding unit:

- Cut off power cord.
- Remove door(s).
- Leave shelves in a place far from reach of children.

Do not use sharp pointed objects to remove excessive grime, use brush if required.

IMPORTANT: do not use solvent or abrasive products for cleaning as they may damage surface finish.

5.3 EVAPORATOR DEFROSTING

Unit has an automatic evaporator defrosting system to guarantee adequate interior air flow.

If you notice that the unit is forming ice and it does not cool properly, report this issue to the MVP USA Service Department.

Tool to be used



safety shoes



gloves



safety goggles

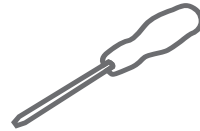

Phillips or flat screwdriver



pliers

How to remove the plastic evaporator housing

- 1) Unscrew the drain nut
- 2) Remove the drain hose
- 3) Remove screws from the evaporator housing.
- 4) Remove the plastic evaporator housing

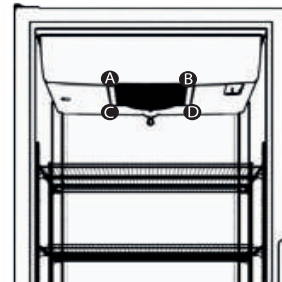

How to remove the tube cover

- 1) Remove grills
- 2) Unscrew the tube cover
- 3) Remove screws from the tube cover
- 4) Remove the tube (s) cover.

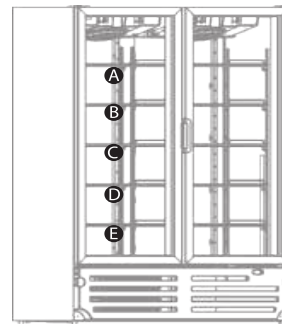

7. TROUBLESHOOTING GUIDE

Failure description	Possible causes	Check	Corrective actions
Cooler cannot be turned on	Power supply failure	Electric power in the business	Wait until electricity service is restored
	Cooler is not well connected	Outlet must have electrical power	Wait until electricity service is restored
	Loose connection	Plug is well connected	Correctly connect plug to contact
	Just connected and no more than 5 minutes have passed		Wait for at least 5 minutes for compressor to start running.
	Burned fuse or tripped circuit breaker	Physical state of fuse or circuit breaker	Replace fuse or reset circuit breaker
Cooler vibrates and/or makes noises	It is not correctly leveled on a firm and flat surface	Cooler stability	Make sure you place cooler on a firm and flat surface
		No objects are kept under cooler that might cause instability	Remove any carpeting, carton, or other objects from under cooler
	Level supports are unlevelled	Leveling supports are correctly adjusted	Adjust leveling supports until 4 support points are firm
	Loose parts vibrate or against surfaces or walls	Loose components	Locate and tighten loose parts or adjust those that might hit others
	Tubing vibration is transmitted		Separate parts that due to contact may be vibrating together
Equipment works continuously for long periods of time	Condenser coil is dirty		Clean coil to remove dust, lint and waste



Failure description	Possible causes	Check	Corrective actions
Equipment works continuously for long periods of time	Evaporator coil blocked by frost or frozen	Door closure and seals are firm and adequate throughout perimeter	Turn cooler off to defrost coil. Do not to use a cutter knife or blade for handling. Inappropriate use may scratch or cut off components
	Doors remain open for a long time or doors don't close	Doors closed when not used	Do not allow doors to remain open for prolonged periods of time
	Door magnetic seals do not close or seal	Seal wear	Adjust door or change seals, if necessary
	Hot product load in cabinet is excessive	Review that the shipping brackets has been removed	Allow enough time to cool product
Compressor does not start, makes buzzing noises or stops due to thermal protector	Voltage variation is excessive or undervoltage is observed	If business lamps vary their intensity	Allow for voltage restore and voltage increase
	Vent motor is protected or burnt. Fan blade is damaged	Fan rotation without variations and for complete blade	Call Customer Service Center if required
	Condenser coil is dirty		Clean dust, lint and waste from coil
	Insufficient air flow or blocked		Remove objects that may obstruct air flow or move to provide enough space around it
Cooler inside temperature is too high or does not cool product	More than three hours have not passed since cooler was connected		Wait for a minimum of 14 hours until cooler recovers its temperature
	Condenser coil is dirty		Clean dust, lint and waste from coil

Failure description	Possible causes	Check	Corrective actions
Cooler inside temperature is too high or does not cool product	Evaporator coil blocked by frost or frozen	Door closure and seals are firm and adequate throughout perimeter	Turn cooler off to defrost coil
	Doors remain open for a long time or doors do not close	Doors closed when not used	Do not allow doors to remain open for prolonged periods of time
	Hot product load in cabinet is excessive		Allow enough time to cool product
	Poor or obstructed air flow		Arrange product to allow adequate air flow. Ensure load does not exceed max fill height label
Temperature inside cooler is too low and freezes product	Product is located too close to evaporator	Product is not near fan inlet	Place product at least 2 inches away
Equipment works continuously for long periods of time	Condenser coil is dirty		Clean coil to remove dust, lint and waste
	Evaporator coil blocked by frost or frozen	Door closure and seals are firm and adequate throughout perimeter	Turn cooler off to defrost coil. Do not to use a cutter knife or blade for handling. Inappropriate use may scratch or cut off components
	Doors remain open for a long time or doors don't close	Doors closed when not used	Do not allow doors to remain open for prolonged periods of time
	Door magnetic seals do not close or seal	Seal wear	Adjust door or change seals, if necessary

Failure description	Possible causes	Check	Corrective actions
Equipment works continuously for long periods of time	Hot product load in cabinet is excessive		Allow enough time to cool product
Compressor does not start, makes buzzing noises or stops due to thermal protector	Voltage variation is excessive or undervoltage is observed	If business lamps vary their intensity	Allow for voltage restore and voltage increase
	Vent motor is protected or burnt. Fan blade is damaged	Fan rotation without variations and for complete blade	Call Customer Service Center if required
	Condenser coil is dirty		Clean dust, lint and waste from coil
	Insufficient air flow or blocked		Remove objects that may obstruct air flow or move to provide enough space around it



8. TECHICAL SUPPORT

PROCEDURE TO REQUEST SERVICE

Before requesting a warranty service make sure you have followed the installation guide outlined in this manual.

When requesting a service call, it is mandatory that the customer provides the following information:

- Company Name - Owner
- Full Address (City, state, zip code) - site
- Telephone and Contact Name – at site & of owner
- Serial #

ADDITIONAL SERVICES

In addition to supporting the MVP product warranty, the MVP USA Service Department also offers:

- Warranty extension service agreements
- Preventive maintenance service agreements
- Sale of original spare parts

IMPORTANT NOTES

MVP has no responsibility for accidents or damage suffered as a result of inadequate wiring, overloads and lack of ground wire, misuse of equipment, lack of training, etc.

This warranty does not cover expenses incurred for freight, transportation, shipping, etc. generated by sending the refrigerator or part thereof for repair and return to the client.



NOTES



NOTES

