

Induction Range

User's Manual

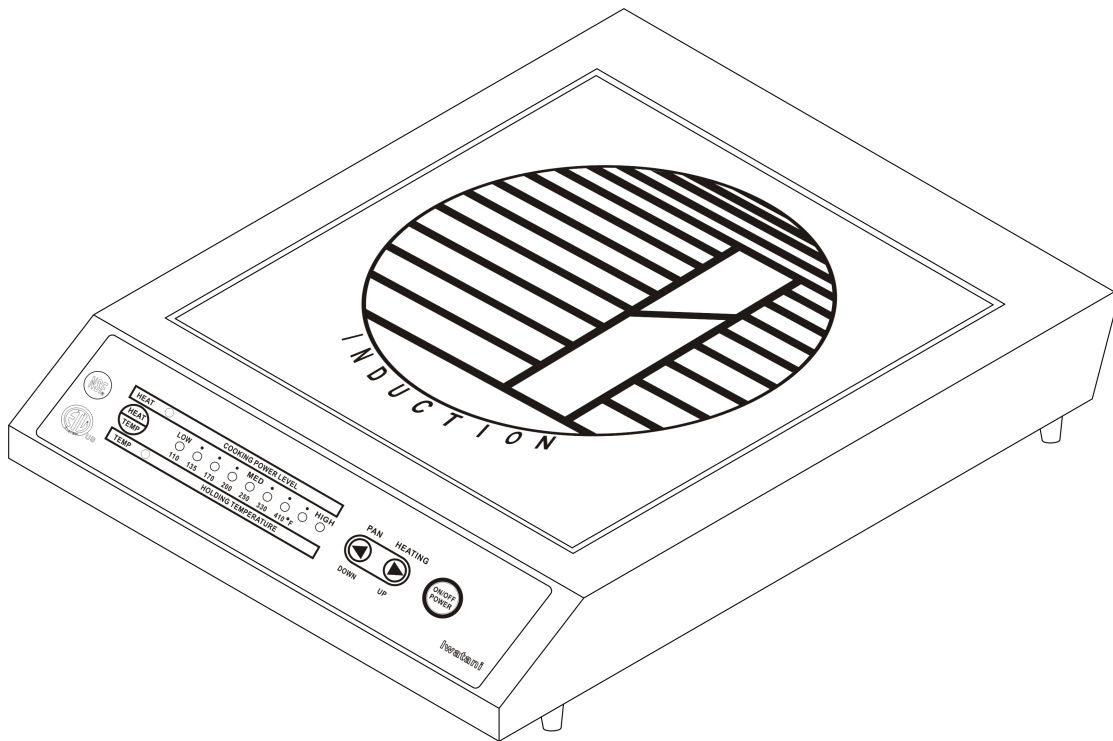

Model No.

- IWA-1800** 120V, 60Hz, 1,800Watt
- IWA-1500** 120V, 60Hz, 1,440Watt
- IWA-2500** 208v/240V, 60Hz
2200Watt @ 208V
2500Watt @ 240V

USE AND CARE INSTRUCTIONS - IMPORTANT SAFEGUARDS

● READ ALL INSTRUCTIONS BEFORE OPERATION ●







1. USE AN INDIVIDUAL 120VOLT, 15AMP FOR IWA-1500 & IWA-1800 ELECTRICAL SOCKET.
IWA-1800 & IWA-1500 120V
USE AN INDIVIDUAL 208VOLT/240VOLT, 15AMP FOR IWA-2500 ELECTRICAL SOCKET.
IWA-2500 208v/240V
2. DO NOT BLOCK THE AIR-OUTLET LOCATED AT THE BACK OF THE INDUCTION RANGE. BLOCKING MAY OVERHEAT THE UNIT.
3. USE PANS 5 INCHES OR LARGER IN DIAMETER. WE RECOMMEND PANS BE LESS THAN 10 1/2 INCHES IN DIAMETER. PLEASE REFER TO THE NEXT PAGE FOR A LIST OF SUITABLE AND UNSUITABLE PANS.
4. DO NOT TOUCH THE HOT SURFACE OF THE VITRO-CERAMIC GLASS PLATE.
NOTE: THE INDUCTION RANGE ITSELF DOES NOT PRODUCE ANY HEAT DURING COOKING. HOWEVER, THE HEAT FROM THE PAN WILL LEAVE THE SURFACE OF THE VITRO-CERAMIC GLASS PLATE HOT !
5. DO NOT COOK EMPTY POTS OR PANS. HEATING AN EMPTY PAN WILL AUTOMATICALLY ACTIVATE THE OVERHEATING PROTECTION DEVICE AND THE UNIT WILL SHUT OFF.
6. PLACE THE INDUCTION RANGE ON A HORIZONTAL SURFACE AND AT LEAST 4 INCHES AWAY FROM THE WALL AND OTHER OBJECTS FOR PROPER VENTILATION.
7. DO NOT PLACE ANY OBJECTS OR TOOLS IN THE AIR-INTAKE (ON THE BOTTOM) OR AIR-OUTLET (ON THE BACK). DOING SO MAY CAUSE ELECTRICAL SHOCK.
8. TO PROTECT AGAINST ELECTRICAL SHOCK, DO NOT IMMERSE THE UNIT, THE CORD, OR THE PLUG IN OR NEAR WATER OR OTHER LIQUIDS.
9. CLOSE SUPERVISION IS NECESSARY WHEN THE INDUCTION RANGE IS USED BY OR NEAR CHILDREN.
10. DO NOT OPERATE THE INDUCTION RANGE IF IT HAS BEEN DAMAGED IN ANY MANNER OR IF THE UNIT MALFUNCTIONS. RETURN THIS UNIT TO THE NEAREST AUTHORIZED SERVICE FACILITY FOR EXAMINATION OR REPAIR.
11. THE USE OF ANY ACCESSORIES NOT RECOMMEND BY THE MANUFACTURER MAY CAUSE INJURIES.
12. KEEP THE POWER CORD AWAY FROM HEAT.
13. DO NOT PLACE THE INDUCTION RANGE IN, ON , OR NEAR OPEN FLAMES, ELECTRIC BURNERS, HEATED OVENS OR OTHER HIGH TEMPERATURE SURROUNDINGS.
14. DO NOT HEAT ANY SEALED CANS ON THE INDUCTION RANGE. A HEATED CAN MAY EXPLODE.
15. DO NOT MOVE THE INDUCTION RANGE WHILE COOKING OR WHEN THE PAN IS HOT.
16. AFTER THE INDUCTION RANGE HAS COOLED DOWN, UNPLUG THE CORD AND CLEAN AS FOLLOWS,
VITRO-CERAMIC GLASS: WIPE WITH DAMP CLOTH OR USE A MILD, NON-ABRASIVE CLEANING SOLUTION.
BODY: WIPE THE CONTROL PANEL WITH SOFT CLOTH OR USE A MILD CLEANER.
17. DO NOT USE INDUCTION RANGE FOR OTHER THAN INTENDED USE.
18. UNPLUG WHEN NOT IN USE.
19. WHEN STORING, DO NOT PLACE ANY OBJECTS ON TOP OF THE INDUCTION RANGE.

SAVE THIS INSTRUCTION !!!

SUITABLE AND UNSUITABLE POTS AND PANS

SUITABLE POTS

1. IRON
2. CAST IRON
3. STAINLESS STEEL
4. ENAMEL WARE

				
Stainless Steel Pan	Iron Pan (Iron Griddle)	Enamel Pan	Stainless Steel kettle	Iron pan
				
Stainless steel fry pan				





ALL POTS AND PANS MUST HAVE A MAGNETIC BOTTOM.

ALL POTS AND PANS MUST HAVE A FLAT BOTTOM.

ALL POTS AND PANS SHOULD HAVE A DIAMETER BETWEEN 5 AND 10 1/2 INCHES.

UNSUITABLE POTS

1. POT WITH DIAMETER BELOW 2 INCHES.
2. STAINLESS STEEL PANS WITH ALUMINUM BOTTOM
3. POTTERY
4. GLASS PANS
5. ALUMINUM PANS
6. BRONZE PANS
7. COPPER POTS
8. PANS WITH FEET

				
Ceramic Pan	Aluminum Pan	Bottom not flat	Dia smaller than 12 cm (4 IN.)	Pan with legs

FEATURES

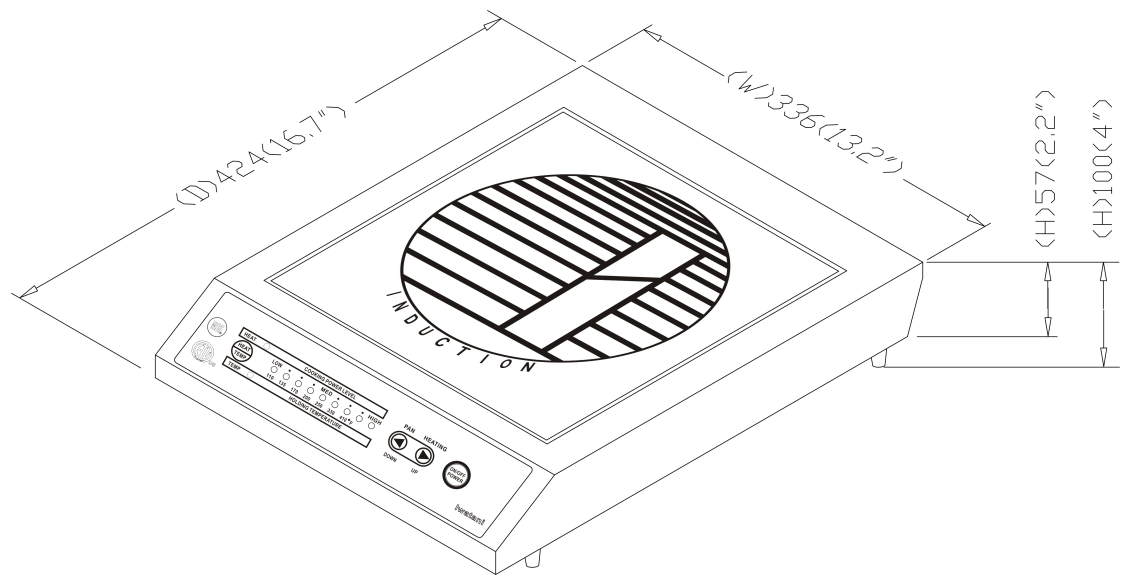
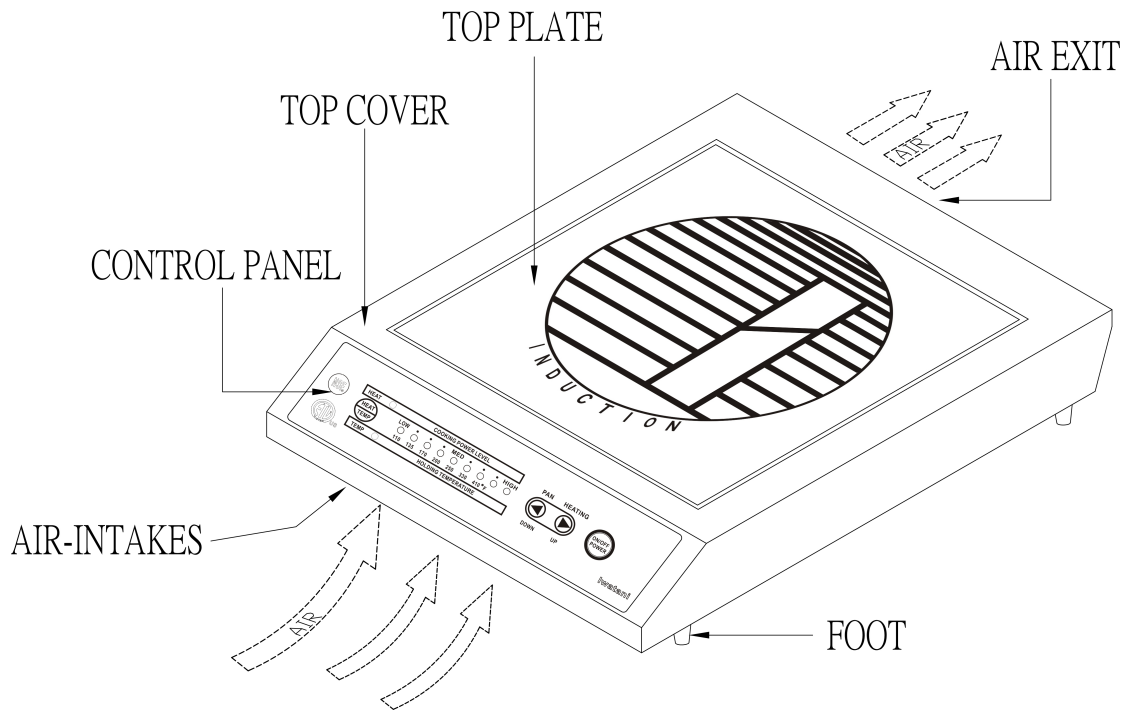

CONTROL PANEL

MODEL NO. IWA-1800

HEAT/TEMP BUTTON

COOKING POWER
MODE INDICATOR
LIGHT

PAN HEATING LIGHT /
SUITABLE PAN
INDICATOR

POWER

BUTTON

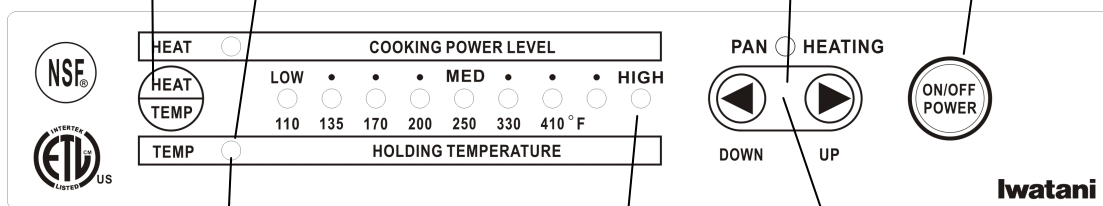

HOLDING
TEMPERATURE
MODE INDICATOR
LIGHT

HEAT/HOLDING
TEMPERATURE
LEVEL INDICATOR
LIGHTS

HEAT/HOLDING
TEMPERATURE
ADJUSTMENT
SWITCHES

MODELNO. IWA-1500

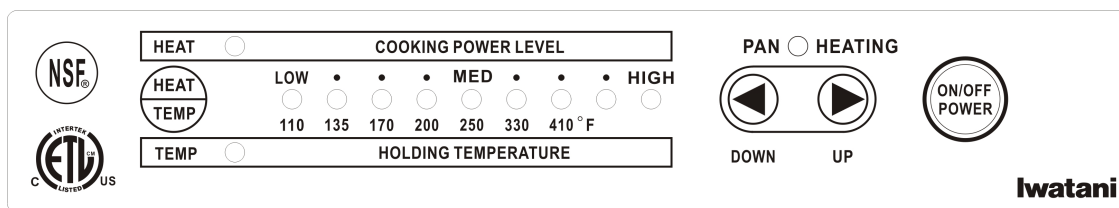

MODELNO. IWA-2500

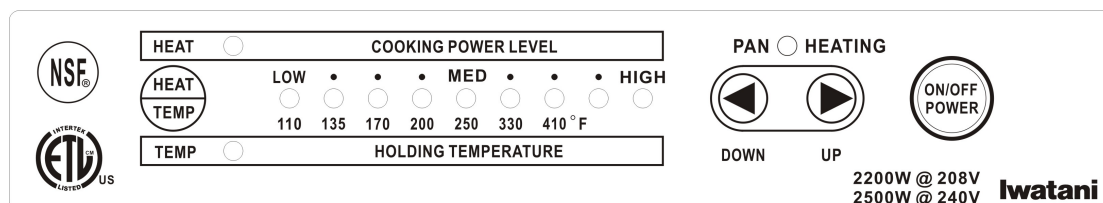

CONTROL KEYS DESCRIPTION

POWER

PRESS THE 'ON/OFF' BUTTON TO TURN THE UNIT ON.
PRESS THE 'ON/OFF' BUTTON AGAIN TO TURN THE UNIT OFF.

HEAT-TEMP FUNCTION

PRESS HEAT-TEMP BUTTON TO SELECT EITHER:

☆ "HEAT" POWER LEVEL CONTROL:

USE FOR MAXIMUM HEATING POWER FOR STIR FRY, OMELETS, ETC.

PRESS THE UP ARROW BUTTON TO SET HIGHER POWER,
PRESS THE DOWN ARROW BUTTON TO SET LOWER POWER.

COOKING POWER LEVEL

LOW ● ● ● ● ● MED ● ● ● ● ● HIGH
● ● ● ● ● ● ● ● ●

☆ "TEMP" HOLDING TEMPERATURE CONTROL:

USE FOR DELICATE SAUCES OR TO MAINTAIN A CONSTANT TEMPERATURE
AFTER COOKING-FUNCTION.

PRESS THE UP ARROW BUTTON TO SET HIGHER TEMPERATURE.
PRESS THE DOWN ARROW BUTTON TO SET LOWER TEMPERATURE.

● ● ● ● ● ● ● ●
110 135 170 200 250 330 410°F ●

HOLDING TEMPERATURE

SAFETY DEVICE

OVERTIME DETECTOR

IF THE PAN IS LEFT ON THE INDUCTION RANGE FOR MORE THAN 2 HOURS, IF THE USER DOES NOT OPERATE ANY FUNCTIONS FOR MORE THAN 2 HOURS, THE RANGE WILL AUTOMATICALLY SHUT OFF.

AUTOMATIC SAFETY SHUT-OFF

IF THE INDUCTION RANGE IS LEFT FOR MORE THAN 60 SECONDS WITHOUT A PAN OR WITH AN INCOMPATIBLE PAN, THE UNIT WILL AUTOMATICALLY SHUT OFF.

MATERIAL COMPATIBILITY DETECTOR

IF THE PAN'S MATERIAL OR IT'S DIMENSIONS ARE NOT SUITABLE FOR THIS INDUCTION RANGE, THE PAN INDICATOR WILL NOT LIGHT.

SMALL OBJECT DETECTOR

THE INDUCTION RANGE WILL NOT RECOGNIZE ANY OBJECTS OR UTENSILS SMALLER THAN 2 INCHES IN DIAMETER. FOR BEST RESULTS, USE PANS THAN ARE BETWEEN 5 AND 10 INCHES IN DIAMETER.

OVERHEATING PROTECTION DEVICE

IF THE PAN'S TEMPERATURE BECOMES TOO HIGH, THERE WILL BE A SHORT WARNING SOUND. YOU MUST EITHER LOWER THE TEMPERATURE OR SELECT A LOWER HOLDING TEMPERATURE WITHIN 60 SECONDS. IF THE TEMPERATURE REMAINS TOO HIGH, THE UNIT WILL SHUT OFF AUTOMATICALLY.

It's recommended that user's of pace makers do not operate this equipment. Or, during operation of the cooking, remain at least 2 feet from the cooker.

SPECIFICATION

MODEL NO.	IWA-1800	IWA-1500	IWA-2500
VOLTAGE	120V / 60Hz		208V / 240V
VITRO-CERAMIC GLASS	APPROX. 10 3/4 INCHES X 10 3/4 INCHES		
ELECTRICAL POWER CONSUMPTION	MAX. 1800W	MAX. 1440W	MAX. 2500W
ELECTRICAL POWER RANGE	APPROX. 300W-1800W	APPROX. 300W-1440W	APPROX. 300W-2500W
APPROVALS	ETLus approval for Commercial Cooking Appliances	cETLus approval for Commercial Cooking Appliances	cETLus approval for Commercial Cooking Appliances
	FCC part 18		
	NSF		
SAFETY DEVICE	<ul style="list-style-type: none"> ◆ Over Time Protector ◆ Automatic Safety Shut-Off ◆ Material Compatibility Detector ◆ Small Object Detector ◆ Overheating Protection Device 		
DIMENSION	(W) 33.6cm x (D) 42.4cm x (H) 100cm (13.23 in. x 16.69 in. x 3.93" in.)		
WEIGHT	6.15 Kgs. 13.55 Lbs.		

FEDERAL COMMUNICATION (FCC) STATEMENT

This equipment has been tested and found to comply with the limits for a Class B digital device, pursuant to Part 18 of the FCC rules. These limits are designed to provide reasonable protection against radio frequency energy and, if not installed and used in accordance with the instructions, may cause harmful interference to radio communications. However, there is no guarantee that interference will not occur in a particular installation. If this equipment does cause harmful interference to radio or television reception, which can be determined by turning the equipment off and on, the user is encouraged to try to correct the interference by one or more of the following measures:

- Reorient or relocate the receiving antenna.
- Increase the separation between the equipment and receiver.
- Connect the equipment into an outlet on a circuit different from that to which the receiver is connected.
- Consult the dealer or an experienced radio/TV technician for help.

Warning:

Use only shielded cables to connect I/O devices to this equipment.

You are cautioned that changes or modifications not expressly approved by the party responsible for compliance could void your authority to operate this equipment.

This device complies with Part 18 FCC Rules.
Operation is subject to the following two conditions:

- (1) This device may not cause harmful interference.
- (2) This device must accept any interference received including interference that may cause undesired operation.

