



Project _____
 AIA # _____ SIS # _____
 Item # _____ Quantity _____ C.S.I. Section 114000



HSL220 Spiral Mixer



MODELS

- HSL220 220 lb. spiral mixer

STANDARD FEATURES

- + Fixed bowl
- + Stainless steel wireform bowl guard
- + Dual electronic timer control
- + Reversible bowl drive
- + Bowl jog control
- + Front and rear casters
- + Adjustable front stabilizing feet
- + Two speeds
- + Aluminum cast cover
- + Steel body frame
- + Powder coat finish

HSL220 - SPIRAL MIXER



SPECIFIER STATEMENT

Specified mixer will be an NSF rated maximum heavy-duty spiral mixer with a fixed bowl, reversible bowl drive and bowl jog control. Mixer has ¾ HP bowl motor and two fixed speeds. Features include adjustable front stabilizing feet, a stainless steel wireform bowl guard and front and rear casters. Mixer finished with a powder coat finish.

Approved by _____ Date _____ Approved by _____ Date _____



SOLUTIONS / BENEFITS

PERFORMANCE

Double Pulley Belt-Driven Motor

- + Creates more torque to handle heavy loads

Bidirectional Bowl Rotation

- + Improves mix consistency and allows batches of dough as small as 10% of maximum capacity to be mixed

Two Mixing Speeds

- + Automatically shift from first to second speed for consistent mixing

Rugged Construction

- + Steel body frame, cast aluminum hood, stainless steel bowl, guard and dough hook/arm

EASE OF USE

Bowl-Pulsing System

- + Designed for quick and easy dough removal

SANITATION & CLEANING

Kneading Zone

- + Absence of debris-collecting crevices allows for simple and fast cleaning

OPERATOR ASSURANCE

Bowl Guard

- + Wireform, stainless steel bowl guard interlock is provided to prevent spiral arm operation when the guard is up

SPECIFICATIONS

Electrical: 208/60/3; 34.5 amps. ETL listed. 380/60/3; 9.6 amps.

Motor: High torque, ball bearing, totally enclosed, fan cooled, polyphase squirrel cage, induction run type. The spiral arm is two speed 3.3/6.0 H.P. The bowl motor is .75 H.P.

Bowl Guard: Wireform, stainless steel. A bowl guard interlock is provided to prevent spiral arm operation when the guard is up.

Drives: The spiral mix arm and the bowl have separate drive systems. Each uses a constant mesh helical gear train that is driven by its motor and multiple belt drive. All gears are lubricated. All shafts run on ball bearings.

Controls: Operator and main control boxes are dustproof. Magnetic contactors with automatic resetting thermal overload protection for each motor. "Start-Stop" push buttons. Reduced voltage fused pilot circuit. Direction of bowl rotation selectable by rotary switch. Bowl can be operated without spiral arm using "Bowl Jog" push button. Unit can operate in continuous mode or with timer.

Timers: Dual electronic timer controls can be set between 0-20 minutes. Time for low and high speeds can be preset to increase productivity. Mixer will automatically shift from low to high speed when the time cycle is completed for low speed. Audible tone informs operator when mix cycle is completed. Large knob dial simplifies setting time.

Speed: Spiral arm speed "one" is 100 RPM. Speed "two" is 200 RPM. The bowl speed is 15 RPM.

Bowl: Polished stainless steel, 170-quart capacity with center post.

Casters: Ball bearing mounted front and rear casters allow easy movement for cleaning. Adjustable front stabilizing feet are provided.

Accessories: Mixer is finished in gray powder coat paint. Top is gray liquid bicomponent paint.

Warranty: Unit has full one-year warranty on parts, labor and mileage against manufacturer's defects. Service contracts are available.

Weight: Shipping – 1,215 lbs.; Net – 1,125 lbs.

MIXER CAPACITY CHART

Product	Flour	Batch
Bread, 60% AR	120 lbs.	220 lbs.
Whole Wheat	120 lbs.	232 lbs.
Thin Pizza, 40% AR	75 lbs.	110 lbs.
Medium Pizza, 50% AR	100 lbs.	155 lbs.
Light Pizza, 60% AR	120 lbs.	170 lbs.
Pie Dough	–	75 lbs.
Bagel Dough, 50% AR	85 lbs.	120 lbs.

NOTE: %AR (% Absorption Ratio) – water weight divided by flour weight. Above capacities are based on 12% flour moisture content and 70°F water. Bread flour was used for bread dough capacities and high gluten flour was used for pizza and bagel doughs.

1 gallon of water weighs 8.33 lbs.

If water temperature is below 55°F or if 25% or more of the water is ice, reduce batch size by reducing flour by 25 lbs. and other ingredients accordingly. Cold water or ice causes dough to be stiff and hard to mix, increasing the load on the mixer transmission and motor.

Pie dough can be successfully mixed in speed 1 with counterclockwise bowl rotation.

DETAILS AND DIMENSIONS

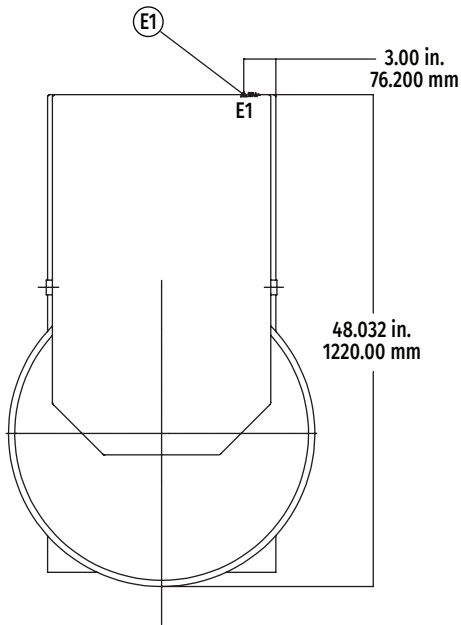

Plugs and Receptacles:

Dependent on local power codes

Machine Voltages		
HSL220	208/60/3	380/60/3
Service Current Requirement if Plug Connected	34.5 amps	9.6 amps
Molded Plug on Cord	No	No
Power Cord Included	Yes	Yes

WARNING: Electrical and grounding connections must comply with the applicable portions of the National Electrical Code and/or other local electrical codes.

