



Model GVP20A



Model #: _____

Serial #: _____

Date of
Purchase: _____



Instruction Manual for Vacuum Packaging Machine Models GVP6, GVP20 and GVP20A

For all after sales support, visit www.globefoodequip.com

- Complete the Warranty Registration
- Find an Authorized Servicer
- View Parts Catalogs

For additional Technical Support call Globe at 1-866-260-0522.

- IMPORTANT SAFETY NOTICE -

This manual contains important safety instructions which must be strictly followed when using this equipment.

Maintain and use this manual as a reference for training.

Intentionally Left Blank

Index

ATTENTION OWNERS AND OPERATORS.....	5
KEY COMPONENTS OF THE VACUUM PACKAGING MACHINE	6
GLOBE SAFETY TIPS	7
UNPACKING AND INSTALLATION	8-9
OPERATING INSTRUCTIONS.....	10-14
CLEANING & SANITIZING.....	15-16
TROUBLESHOOTING	17
RECOMMENDED MAINTENANCE	19
VACUUM PACKAGING MACHINE ACCESSORIES.....	19
LIMITED VACUUM PACKAGING MACHINE WARRANTY	20



GLOBE FOOD EQUIPMENT COMPANY
2153 DRYDEN RD
DAYTON, OH 45439
PHONE: 937-299-5493
TOLL FREE: 800-347-5423
FAX: 937-299-8623
E-MAIL: info@globefoodequip.com
WEBSITE: www.globefoodequip.com

Intentionally Left Blank

Attention Owners and Operators

This equipment is designed to provide safe and productive packaging of food products as long as the equipment is used in accordance with the instructions in this manual and is properly maintained. Importantly, unless the operator is adequately trained and supervised there is a possibility of serious injury. Owners of this equipment bear the responsibility to make certain that this equipment is used properly and safely, to strictly follow all the instructions contained in this manual and the requirements of local, state or federal law.

Owners should not permit anyone to touch this equipment unless they are over 18 years old, are adequately trained and supervised, and have read and understand this manual. Owners should also ensure that no customers, children, visitors or other unauthorized personnel come in contact with this equipment. Please remember that we cannot anticipate every circumstance or environment in which our equipment will be operated. It is the responsibility of the owner and the operator to remain alert to any hazards posed by the function of this equipment and all moving parts. If you are ever uncertain about a particular task or the proper method of operating this equipment, ask your supervisor.

To prevent illness caused by the spread of food-borne pathogens, it is important to properly clean and sanitize the entire vacuum packaging machine as any surface of the vacuum packaging machine can become contaminated. It is the responsibility of the vacuum packaging machine owner/operator to follow all guidelines, instructions and laws as established by your local and state health departments and the manufacturers of chemical sanitizers.

When cleaning your vacuum packaging machine, pay particular attention to cracks, broken seams and any area that may collect food debris. If your vacuum packaging machine, or any of its parts, are damaged or broken, it may become more difficult to properly clean and sanitize the unit. If your vacuum packaging machine is damaged or needs repair, contact an experienced service individual immediately to ensure the vacuum packaging machine can be properly sanitized. If you have any questions, please contact Globe at 866-260-0522.

Throughout the manual you will see warnings to help alert you to potential hazards and to help promote safe use of this equipment.

Warnings affecting your personal safety are indicated by:



Warnings related to possible damage to the equipment are indicated by:



Make certain that the instruction manual is available for easy reference by any operator. English and French language warning labels have been placed on the vacuum packaging machine. If the warning labels or this manual are misplaced, damaged, or illegible, or if you require additional copies, please contact your nearest representative or the factory directly for these items at no charge.

Please remember that neither this manual nor the warning labels replace the need to be alert, to properly train and supervise operators, and to use common sense when using this equipment.

Key Components of the Vacuum Packaging Machine

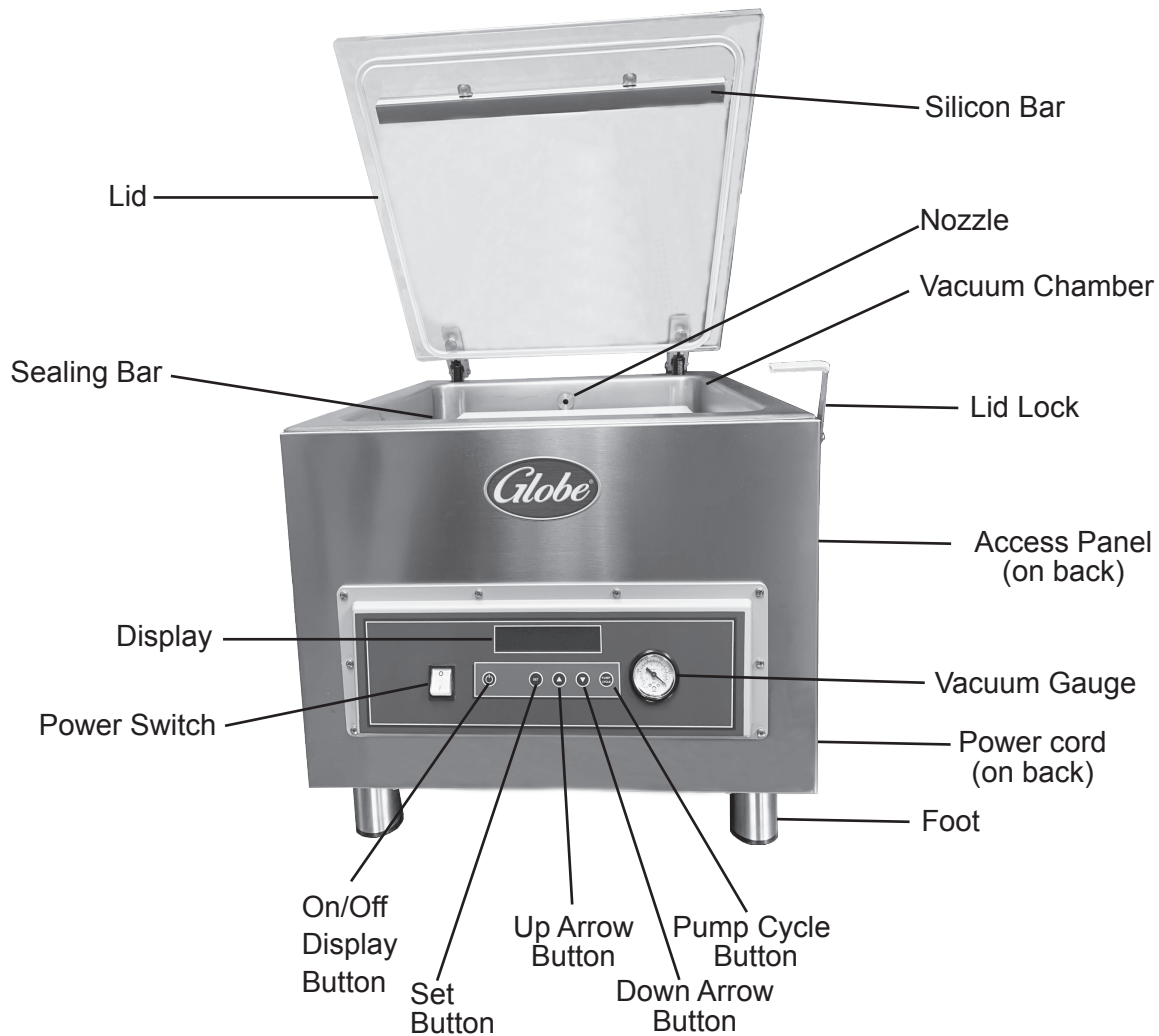

GVP20A

Globe Safety Tips



**Risk of
Electrical
Shock**

TO AVOID SERIOUS PERSONAL INJURY:

- **NEVER** touch vacuum packaging machine before reading and completely understanding everything in this instruction manual. You must be at least 18 years old and have had proper training and authorization from your supervisor.
- **NEVER** bypass, alter or modify this equipment in any way from its original condition. Doing so can create hazards and will void the warranty.
- **ALWAYS** ground vacuum packaging machine utilizing proper power source.
- **KEEP unit UNPLUGGED** when not in use to prevent accidental start up.
- **ALWAYS** keep hands and arms away from all moving parts.
- **BEFORE CLEANING, SERVICING, OR REMOVING ANY PARTS** always turn vacuum packaging machine OFF and unplug power cord.
- **ALWAYS** properly clean and sanitize your vacuum packaging machine to prevent illness or death caused by the spread of food-borne pathogens.
- **USE ONLY PROPERLY INSTALLED GLOBE ACCESSORIES.**

Unpacking & Installation



TO AVOID SERIOUS PERSONAL INJURY, USE VACUUM PACKAGING MACHINE IN A SUFFICIENT WORK AREA

- **ALWAYS** use equipment in a work area with sufficient light and space.
- **NEVER** bypass, alter or modify this equipment in any way from its original condition. Doing so can create hazards and will void the warranty.
- **NEVER** operate vacuum packaging machine without all warnings attached.

UNPACKING:

1. Inspect the package carefully before unpacking. Note any damage on the delivery paperwork and take pictures.
2. Unpack the vacuum packaging machine immediately after receipt. If the machine is found to be damaged, save the packaging material and take pictures of damage. Contact Globe Food Equipment as soon as possible. Contact information and further details can be found at <https://globefoodequip.com/support/order-return-policy.html>
3. You should receive the vacuum packaging machine, two filler plates, pump oil, Allen wrench and an instruction manual. Contact the factory or your local supplier if you did not receive all of these materials.
4. Read this manual thoroughly before operation. DO NOT continue with use of the vacuum packaging machine if you have any questions or do not understand everything in the manual. Contact your local representative or the factory first.
5. Remove vacuum packaging machine from the corrugated box.
6. Make sure warning labels are correctly positioned, legible, and instruction manual is available near vacuum packaging machine.
7. Screw legs into the permanently fastened nuts on the four corners of the unit and tighten by hand. Legs must be installed to adequately provide proper cleaning under the unit.
8. Level unit by adjusting the four feet and tighten securely. The feet have an adjustment of one inch to line up with other Globe countertop products. Do not slide unit with legs installed: use two people to lift if necessary to move unit.
9. Release the lid lock located on the right side of the vacuum packaging machine and allow the lid to lift and remain open.

Note: To extend the life of the lid hinges, leave the lid open when vacuum packaging machine is not in use.

10. Install oil provided with the vacuum packaging machine in the motor/pump.
 - a. Locate the access panel on the back of the vacuum packaging machine.
 - b. Unscrew four screws that attach the access panel to the back of the vacuum packaging machine.
 - c. Use the provided Allen wrench to remove the nut above the sight glass.
 - d. Install the oil in the motor/pump.

Note: Make sure oil level is halfway between the MIN and MAX indicator lines on the motor/pump.

Unpacking & Installation

CONNECTING TO ELECTRICAL POWER



THIS MACHINE IS PROVIDED WITH A THREE-PRONG GROUNDING PLUG. THE OUTLET TO WHICH THIS PLUG IS CONNECTED MUST BE PROPERLY GROUNDED. IF THE RECEPTACLE IS NOT THE PROPER GROUNDING TYPE, CONTACT AN ELECTRICIAN. DO NOT UNDER ANY CIRCUMSTANCES CUT OR REMOVE THE THIRD GROUND PRONG FROM THE POWER CORD OR USE ANY ADAPTER PLUG (FIGURE 9-1 AND FIGURE 9-2).

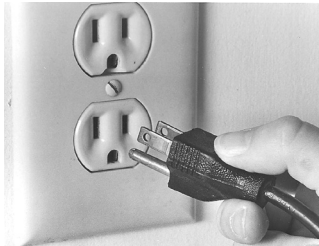

Figure 9-1 Correct

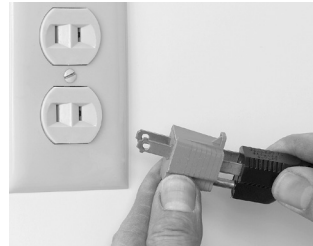

Figure 9-2 Incorrect

1. Complete the online warranty/registration at:
www.globefoodequip.com/support/warranty-registration-form.
2. Before use, clean and sanitize vacuum packaging machine. Refer to Cleaning and Sanitizing section of this manual.
3. Contact your local representative, or the factory directly, if you have any questions or problems with the operation of the vacuum packaging machine.

Operating Instructions

⚠ WARNING

TO AVOID SERIOUS PERSONAL INJURY:

- **NEVER** touch vacuum packaging machine without training and authorization from your supervisor or if you are under 18 years old. Read the instruction manual first.
- **ONLY** use the vacuum packaging machine in a clean, well-lighted work area away from children and visitors.
- **NEVER** put hands or fingers into the vacuum packaging machine during operation.
- **BEFORE CLEANING, SERVICING, OR REMOVING ANY PARTS**, always turn vacuum packaging machine OFF and unplug unit.
- **KEEP unit UNPLUGGED** when not in use to prevent accidental start up.

VACUUM PACKAGING MACHINE OPERATION (MODELS GVP6 AND GVP20)

⚠ CAUTION

- **Do not operate vacuum packaging machine without first checking/installing oil into the motor/pump. Damage to vacuum packaging machine will occur.**
- **Activate the pump cleaning every 2000 cycles or monthly to prevent damage to the motor/pump. Refer to the Cleaning Section for instructions on how to activate the pump.**

1. Place one or two of the filler plates in the vacuum packaging machine in order to level the product with the height of the sealing bar (Figure 10-2).

Note: Filler plates can be used to reduce the required vacuum time. Filler plates take up space, leaving less air to be removed from the vacuum chamber.

2. Place the vacuum sealing bag (or bags) with the product, inside the vacuum chamber.
3. Position the vacuum sealing bag with the opening flat on the sealing bar (Figure 10-3).

Note: Any excess top portion of the vacuum sealing bag should be placed between the vacuum chamber wall and the seal bar. Excess top portion should not exceed 2 cm over the vacuum sealing bag.

Note: Make sure to place any vacuum sealing bag that contains liquids or wet product below the height of the seal bar.

4. Turn on the ON/OFF switch. ON/OFF switch light will illuminate. Display will show current vacuum mode setting (Figure 10-4).

Note: The quality of the vacuum can be verified by checking the tightness of the pouch and the product. Check for air pockets or air leaks. If product is not vacuum packaged tightly, increase the vacuum time by 5 seconds, vacuum and seal again.

5. Select the required vacuum time by pressing the VACUUM “up” or “down” arrows on the control panel.



Figure 10-2



Figure 10-3

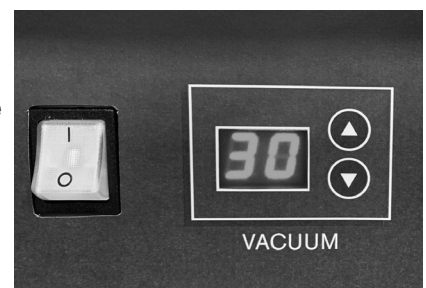

Figure 10-4

Operating Instructions

Note: The quality of the seal can be verified by checking that the seal is clear. If the seal is spotty or incomplete, increase the seal time by 0.1 second. If the seal appears white or milky, decrease the seal time by 0.1 second.

6. Select the SEAL “up” or “down” arrow buttons to increase or decrease the time of sealing (tenths of a second, between 2 and 9.9 seconds) (Figure 11-1).
7. Lower the lid to start the vacuum cycle. When lid is fully closed the vacuum cycle will begin.

Note: To completely stop the vacuum cycle, select and hold the STOP button for 2-3 seconds.

Note: To stop the vacuum cycle and seal the vacuum sealing bag, select and hold the STOP/SEAL button for 2-3 seconds.

8. If at anytime during the cycle, the vacuum needs to be stopped, select and hold either the STOP or the STOP/SEAL button for 2-3 seconds.
9. Once the vacuum cycle is complete, the lid will automatically open.

PROGRAM SETTINGS (MODELS GVP6 AND GVP20)

1. Turn on the ON/OFF switch. ON/OFF switch light will illuminate. Display will show program number “P0” on the VACUUM. After 5 seconds the Vacuum and Seal settings will display (Figure 11-2).

2. Select and hold the SEAL “up” and “down” buttons for 2 seconds to enter display settings (Figure 11- 3).

Note: The “P0” indicates the program that is being used. Up to 9 programmable programs are available on Model GVP6 and GVP20.

3. Select the VACUUM “up” or “down” buttons to select the correct program (Figure 11-4).
4. Select and hold the SEAL “up” button to change the program settings.
5. Select the VACUUM or SEAL “up” and “down” buttons to select the setting.
6. Lower the lid to start the vacuum cycle to confirm the selected settings.
7. Select and hold the SEAL “up” and “down” buttons to save the program.
8. Select the SEAL “down” button to return to operation.

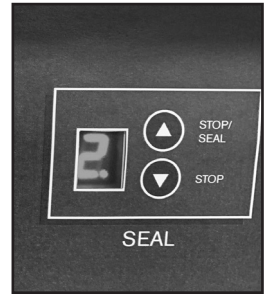

Figure 11-1

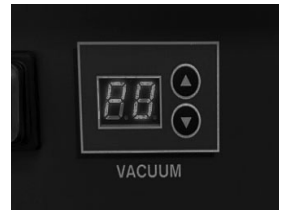

Figure 11-2

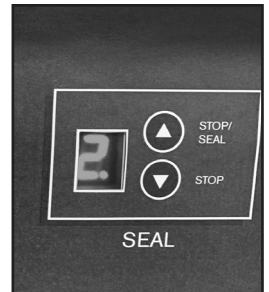

Figure 11-3

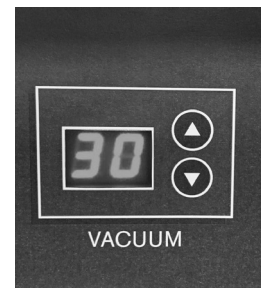

Figure 11-4

Operating Instructions

USER SETTING MENU (MODEL GVP20A)

1. Hold down the SET and ON/OFF buttons for 2-3 seconds. Display will show Language Setting (Lang) (Figure 12-1).
 - a. Use the "up" or "down," arrow buttons to select the desired language: English, Italian, Spanish, German or French.
 - b. Select the SET button to confirm and move to the next option.
2. Display (Figure 12-2).

Note: Display mode is used when the vacuum packaging machine is equipped with a printer option.

- a. Select the "up" or "down" arrow buttons to select 0 for fixed hour/date or 1 for intermittence hour/date.
 - b. Select the SET button to confirm and move to next option.
3. Time/date setting (Figure 12-3).
 - a. Use the "up" or "down" arrow buttons to select the desired time and date.
 - b. Select the SET button to select the time. Time is set in 24 hour format.
 - c. Select the SET button to select the date. Date is set as DD/MM/YY.
 - d. Select the SET button to confirm and move to the next option.



Figure 12-1



Figure 12-2



Figure 12-3

PROGRAM SETTINGS (MODEL GVP20A)

1. Turn on the ON/OFF switch. ON/OFF switch light will illuminate. Display will show Program number, time and date (Figure 12-4).
2. Select and hold the ON/OFF display button for 3 seconds to enter display settings (Figure 12- 5).

Note: The "1" indicates the program that is being used. Up to 20 programmable programs are available on Model GVP20A.

Note: Each program can be set to save individual vacuum percentage settings, seal, gas settings and vacuum mode (soft vacuum option).

3. Select the "up" or "down" arrow buttons to select the correct program.
4. Select the SET button to select vacuum percentage setting. Display will show current vacuum percentage setting (Figure 12- 6).
5. Select the "up" or "down" arrow buttons to increase or decrease the vacuum percentage (40% to 99%).



Figure 12-4

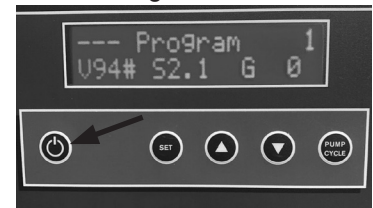

Figure 12-5



Figure 12-6

Operating Instructions

Note: Extra Vacuum setting extends the vacuum suction for 15 seconds when the vacuum machine has reached 99% vacuum. This allows for a better vacuum, closer to 99.99%.

1. Select the SET button. Display will show Extra Vacuum mode setting (Figure 13-4).
2. Select the "up" or "down" arrow buttons to increase or decrease the extra vacuum percentage (1 to 15 seconds).
3. Select the SET button. Display will show current vacuum mode setting (Figure 13-5).

Note: Vacuum Mode 1, allows the pump intermittence working to vacuum liquids and creamy products. The vacuum mode 1 consists of 4 seconds of vacuum and 7 seconds of pause until the end of the total vacuum time.

4. Select vacuum mode 0 for standard vacuum or vacuum mode 1 for soft vacuum with pump intermittence.

Note: Marinating using the vacuum packaging machine, allows the marinate to reach the food product more quickly.

5. Hold down the SET button for 2 seconds to enter the submenu to select the marinating setting.
6. Press SET button until the words "Marination 0" appear (Figure 13-6).

Note: Marinating time setting can be set in 10 minute increments.

7. Select the "up" or "down" arrow buttons to increase or decrease the minutes from 0 to 180.
8. Press SET to confirm the value and exit the submenu.

Note: Display program will show a "#" (pound sign) if a time value different from "0" has been selected (Figure 13-7).

9. Once the set marinating time or vacuum percentage has been selected, close the lid to start the vacuum cycle.

Note: The vacuum packaging machine will countdown the set minutes for marinating.

10. At the end of marinating, the vacuum packaging machine lid will open and the vacuum sealing bag will be sealed.

Note: To stop the marinating process in progress, select the ON/OFF display button. The lid will open without sealing the vacuum sealing bag.

Note: To stop the marinating process and seal the vacuum sealing bag, select the PUMP CYCLE button.

11. Select the SET button. Display will show current seal setting (Figure 13-8).
12. Select the "up" or "down" arrow buttons to increase or decrease the time of sealing (tenths of a second, between 0 and 9.9 seconds).
13. Select the SET button to confirm the setting or select the next option.

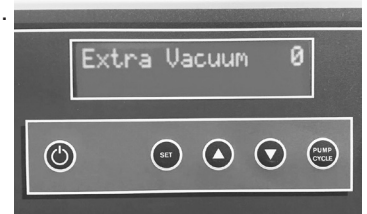

Figure 13-4



Figure 13-5



Figure 13-6



Figure 13-7



Figure 13-8

Operating Instructions

Note: If no other options are available, display will return to the program number modified.

14. Connect the hose from the gas cylinder to the nozzle in the vacuum chamber.
15. Select the SET button. Display will show current gas setting (Figure 14-2).



Figure 14-2

CAUTION Do not set time of gas flush longer than vacuum time. The lid will open, anticipating the end of the cycle.

CAUTION Make sure the gas pressure entering the chamber is not higher than 1-1.5 bar.

16. Select the “up” or “down” arrow buttons to increase or decrease the time of the gas injection (tenths of seconds, between 0 and 9.9 seconds).
17. Select the SET button to confirm the setting or select the next option.



Figure 14-3

VACUUM PACKAGING MACHINE OPERATION MODEL GVP20A

CAUTION Do not operate vacuum packaging machine without first checking/installing oil into the motor/pump. Damage to vacuum packaging machine will occur.

1. Place one or two of the filler plates in the vacuum packaging machine in order to level the product with the height of the sealing bar (Figure 14-3).

Note: Filler plates can be used to reduce the required vacuum time. Filler plates take up space, leaving less air to be removed from the vacuum chamber.

2. Place the vacuum sealing bag (or bags) with the product, inside the vacuum chamber.
3. Position the vacuum sealing bag with the opening flat on the sealing bar (Figure 14-4).

Note: Any excess top portion of the vacuum sealing bag should be placed between the vacuum chamber wall and the sealing bar. Excess top portion should not exceed 2 cm over the vacuum sealing bag.

Note: Make sure to place any vacuum sealing bag that contains liquids or wet product below the height of the seal bar.

4. Turn on the ON/OFF switch to power on the vacuum packaging machine. The ON/OFF switch light will illuminate (Figure 14-5).
5. Refer to Program Settings in order to select the correct settings for the vacuum chamber.
6. Once settings have been selected, lower the lid to start the vacuum cycle. When lid is fully closed the vacuum cycle will begin.
7. If at anytime during the vacuum cycle the vacuum cycle needs to be stopped, select and hold the ON/OFF display button for 3 seconds (Figure 14-6).

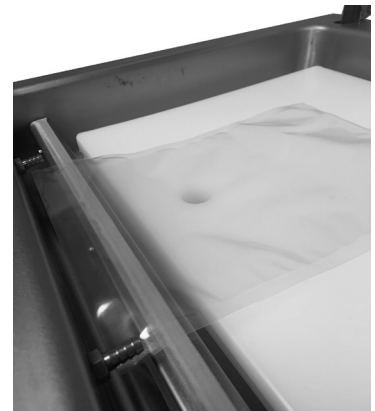

Figure 14-4



Figure 14-5

Note: The vacuum packaging machine will allow the air to enter the vacuum chamber and the lid will open.

Note: To stop the vacuum cycle and seal the vacuum sealing bag, select and hold the PUMP CYCLE button for 2-3 seconds.



Figure 14-6

8. Once the vacuum cycle is complete, the lid will automatically open.

Cleaning & Sanitizing

WARNING

TO AVOID SERIOUS PERSONAL INJURY:

- **BEFORE CLEANING, SERVICING, OR REMOVING ANY PARTS**, always turn vacuum packaging machine OFF and unplug unit.
- **NEVER** attempt to clean vacuum packaging machine while vacuum packaging machine is in operation.

CAUTION

- **Dilute detergent per supplier's instruction.** Products containing sodium hypochlorite should not be used on vacuum packaging machine.
- **DO NOT** hose down, pressure wash, or pour water on vacuum packaging machine.
- **NEVER** use a scrubber pad, steel wool, or abrasive material to clean vacuum packaging machine.

WARNING

To prevent illness or death caused by the spread of food-borne pathogens, it is important to properly clean and sanitize the entire vacuum packaging machine as any surface of the vacuum packaging machine can become contaminated. It is the responsibility of the vacuum packaging machine owner/operator to follow all guidelines, instructions and laws as established by your local and state health departments and the manufacturers of chemical sanitizers.



Once your vacuum packaging machine makes contact with food product, the entire vacuum packaging machine, including removable parts, must be thoroughly cleaned and sanitized. This process is to be repeated at least every 4 hours using these procedures and information; and must comply with additional laws from your state and local health departments.



As with all food contact surfaces, it is extremely important to properly sanitize the entire vacuum packaging machine and to **closely follow the instructions on your quaternary sanitizer container to make sure proper sanitation is achieved to kill potentially harmful bacteria.**

IMPORTANT: If a chemical sanitizer other than chlorine, iodine or quaternary ammonium is used, it must be applied in accordance with the EPA-registered label use instructions. Excessive amounts of sanitizer and use of products not formulated for stainless steel or aluminum can VOID your warranty.

Sanitizer concentration must comply with section 4-501.114, Manual and Mechanical Warewashing Equipment, Chemical Sanitization - Temperature, pH, Concentration, and Hardness of the FDA Food Code.

For more information on proper kitchen and equipment sanitation, visit www.servsafe.com provided by the National Restaurant Association (NRA).

CAUTION

- **ALWAYS** turn vacuum packaging machine OFF and unplug the power cord BEFORE cleaning.
- It is extremely important to follow the instructions on the sanitizer container to make sure proper sanitation is achieved. Allow the parts to air dry before placing them back on vacuum packaging machine!

Cleaning & Sanitizing

VACUUM PACKAGING, CLEANING AND SANITIZING

1. Make sure the vacuum packaging machine is turned OFF and unplugged.

CAUTION

**Do not place the sealing bar in a dishwasher, hand wash only.
Damage to the sealing bar can occur.**

2. Remove the sealing bar. Clean the sealing bar with mild detergent and warm water solution. Sanitize the sealing bar and allow part to air dry (Figure 16-1).
3. Remove the filler plates. Clean the filler plates with mild detergent and warm water solution. Sanitize the filler plates and allow to air dry (Figure 16-2).
4. With a clean damp cloth soaked in mild detergent, wipe down the lid, silicon bar on the lid and the vacuum chamber to remove any food, debris and grease/oil (Figure 16-3).
5. Sanitize the vacuum packaging machine following the instructions on your quaternary sanitizer container. Allow vacuum packaging machine to air dry.
6. Make sure that all surfaces are dry before reassembling the unit.



Figure 16-1



Figure 16-2

PUMP CLEANING

CAUTION

Cleaning the pump doesn't replace the need to maintain the oil in the pump. Oil must be replaced when it is no longer clear, approximately every 4 months or 2000 cycles. Damage to the pump can occur.

Note: Every 2000 cycles or monthly, it is recommended to activate the pump cleaning in order to make oil more fluid and dispose of any impurities.

1. Hold the VACUUM "up" and "down" arrows on the control panel for 3 seconds.
2. Close the lid and hold firmly closed.
3. Select the VACUUM "up" button for 2 seconds (Figure 16-4).
4. Vacuum Display will show PC (Pump Cleaning).

Note: Each of the 9 cleaning steps will take approximately one minute.

5. The Seal Display will begin to countdown starting at 9 and will go until 0.
6. To interrupt the cleaning cycle at anytime during cleaning select and hold the Seal "down" button for 2 seconds.
7. Hold the Seal "down" button for 2 seconds to exit the pump cleaning.



Figure 16-3

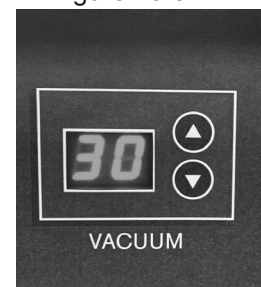

Figure 16-4

Troubleshooting

ISSUE	CAUSE	SOLUTION
Vacuum packaging machine does not start.	Vacuum is unplugged.	Plug in vacuum packaging. Turn on the ON/OFF switch to start. Light will illuminate.
Vacuum packaging machine stops unexpectedly while it is running.	Check that the rear microswitch is correctly energized.	Make sure microswitch under the left hinge is correctly energized when the lid is lowered.
Vacuum sealing bag is not sealed or is not sealed correctly at lid opening.	One or more of the two cables have disconnected from the sealing bar.	Make sure the 2 cables are fixed to the sealing bar.
	Sealing time not suitable for the vacuum sealing bag thickness.	Adjust the seal time for the vacuum sealing bag thickness.
	Vacuum sealing bag is wet or creased.	Make sure the vacuum sealing bag is not wet or that there are no creases.
	Silicone bar on lid is damaged.	Clean or replace the silicone bar on the lid.
Vacuum packaging machine does not maintain the optimum vacuum.	Oil is old.	Change the oil.
	Cleaning pump	Call for service.
	Vane pump	Call for service.
	Seal on lid needs cleaned or replaced.	Clean or replace the seal on the lid.
Air leaking from lid.	Seal on lid needs cleaned or replaced.	Clean or replace the seal on the lid.
Vacuum sealing bag starts to swell during vacuum cycle.	Vacuum sealing bag not in correct position.	<p>Stop the vacuum packaging machine and reposition the vacuum sealing bag on the sealing bar.</p> <p>Make sure that the bags excess portion is straight and does not reach the vacuum packaging machine chamber walls.</p>
Lid does not lift properly.	Pistons are not properly placed inside of vacuum packaging machine.	Call for service to adjust pistons.

If problem continues and the above solution does not remedy the issue, please call Globe's Service Department at 866-260-0522.

Intentionally Left Blank

Recommended Maintenance

PART	REQUIRED ACTION	FREQUENCY
Pump	Check oil level on pump. If oil level is low, apply pump oil to pump.	Every Month
	Check to make sure oil is clear. If oil begins to look "milky" the oil must be changed.	When using the vacuum packaging machine with flour products, it is necessary to check the oil monthly. For standard use, the oil will likely need changed Every 5,000 cycles or 4 months.
	Pump cleaning. Push the "PUMP CYCLE" button and lower the lid at the same time. Pump Cleaning will appear on display. When cleaning is complete, "OIL" will no longer display and the program number will appear.	When "OIL" appears on display.
Pump Heating (GVP20A Only)	<p>With vacuum packaging machine lid open, press the button "PUMP CYCLE" for 3 seconds and let the pump work for 5 seconds. Press the "PUMP CYCLE" button to stop the pump.</p> <p>Run the pump, but not at full power, for few seconds. Lower the lid until the pump starts. Open the lid after 5 seconds. Repeat two or 3 times.</p>	During winter time or cold weather, it is recommended to pre-heat the pump in the morning in order to liquefy the oil before it circulates throughout the vacuum packaging machine.
Sealing Bar	Clean the sealing bar with alcohol.	Every day. Replace sealing bar every 200 working hours.
Silicon Bar	Clean the silicon bar with alcohol.	Every day. Replace silicon bar every 200 working hours.
Oil Filter	Replace the oil filter.	Every year.

Vacuum Packaging Accessories

XBAGS Pack of vacuum sealing bags

Limited Vacuum Packaging Machine Warranty

Globe Food Equipment Company ("GFE") warrants to the original purchaser of new equipment that said equipment, when installed in accordance with our instructions within North America and subjected to normal use, is free from defects in material or workmanship for a period of 1 year on parts (excludes wear/expendable parts). The labor warranty is one year from original installation or 18 months from actual shipment date, whichever date occurs first.

THIS WARRANTY IS IN LIEU OF ALL OTHER WARRANTIES, WHETHER EXPRESSED OR IMPLIED. GFE EXPRESSLY DISCLAIMS ANY IMPLIED WARRANTY OF MERCHANTABILITY OR EXPRESSED OR IMPLIED WARRANTY OF FITNESS FOR A PARTICULAR PURPOSE.

GFE'S OBLIGATION AND LIABILITY UNDER THIS WARRANTY IS EXPRESSLY LIMITED TO REPAIRING AND REPLACING EQUIPMENT WHICH PROVES TO BE DEFECTIVE IN MATERIAL OR WORKMANSHIP WITHIN THE APPLICABLE WARRANTY PERIOD. All repairs pursuant to this Warranty will be performed by an Authorized Designated GFE Service Location during normal working hours. IN NO EVENT SHALL GFE BE LIABLE FOR INCIDENTAL OR CONSEQUENTIAL DAMAGES TO BUYER OR ANY THIRD PARTY, INCLUDING, WITHOUT LIMITATION, LOSS OF PROPERTY, PERSONAL INJURY, LOSS OF BUSINESS OR PROFITS OR OTHER ECONOMIC LOSSES OR STATUTORY OR EXEMPLARY DAMAGES, WHETHER IN NEGLIGENCE, WARRANTY, STRICT LIABILITY OR OTHERWISE.

This warranty is given only to the first purchaser from a retail dealer. No warranty is given to subsequent transferees.

This warranty does not cover product failures caused by: failure to maintain, neglect, abuse, damage due to excess water, fire, normal wear, improper set up and use. Periodic maintenance is not covered.

Example of items not covered under warranty, but not limited to just these items:

1. Acts of God, fire, water damage, burglary, accident, theft.
2. Freight damage.
3. Improper installation or alteration of equipment.
4. Use of generic or after market parts.
5. Repairs made by anyone other than a GFE designated servicer, or not pre-authorized by GFE.
6. Lubrication.
7. Expendable wear parts, knife, rubber boots, blown fuses, lamps.
8. Cleaning of equipment.
9. Misuse or abuse.

Service under this warranty is not in force until such time as a properly completed, digitally signed, Installation/Warranty Registration has been received by GFE within 30 days from the date of installation. Complete warranty registration at: www.globefoodequip.com/support/warranty-registration-form.

THE FOREGOING WARRANTY PROVISIONS ARE A COMPLETE AND EXCLUSIVE STATEMENT BETWEEN THE BUYER AND SELLER. GFE NEITHER ASSUMES NOR AUTHORIZES ANY PERSONS TO ASSUME FOR IT ANY OTHER OBLIGATION OR LIABILITY IN CONNECTION WITH SAID EQUIPMENT.

WARRANTY REGISTRATION
GO TO WWW.GLOBEFOODEQUIP.COM
TO FILL OUT AND SUBMIT YOUR WARRANTY REGISTRATION.

WWW.GLOBEFOODEQUIP.COM/SUPPORT/WARRANTY-REGISTRATION-FORM