



OWNER'S MANUAL



Instructions for the installation, operation and maintenance of all Centerline™ by Traulsen: Reach-In Refrigerators & Freezers*

*Please Note: This manual is intended for use with the above referenced equipment manufactured after May 01, 2020.

4401 Blue Mound Road Fort Worth, Texas 76106 (USA)

Phone: 800.825.8220 | Service Fax: 817.740.6757 | E-mail: service@traulsen.com | Website: centerlinefoodequipment.com

Form Number: TR36229 | Part Number: 375-60364-00 | Revision Date: 06-09-20

Hours of Operation: Monday - Friday 7:30 a.m. - 4:30 p.m. (CST)

TABLE OF CONTENTS

I. THE SERIAL TAG	Page 1	V. CARE AND MAINTENANCE	Page 5
a) Serial Tag & Location	Page 1	a) Cleaning the Condenser	Page 5
b) Reading The Serial Tag	Page 1	b) Hinge Replacement	Page 6
II. RECEIPT INSPECTION	Page 2	c) Replacing the Gaskets	Page 6
III. INSTALLATION	Page 2	d) Cleaning the Exterior	Page 6
a) Location	Page 2	e) Cleaning the Interior	Page 6
b) Packaging	Page 2	f) Adjusting the Shelves	Page 7
c) Installing Legs or Casters	Page 2	VI. CONTROL BASICS	Page 7
d) Installing Drain Pan	Page 3	a) Information Menu	Page 7
e) Shelves	Page 3	b) Adjusting Cabinet Setpoint	Page 7
f) Removing Doors and Hardware	Page 3	c) Initiating a Defrost	Page 7
g) Door Removal for Half Door Units	Page 4	d) Configuration Parameters	Page 8
h) Cord & Plug	Page 4	e) Technical Data	Page 8
i) Power Supply	Page 4	f) Componets and Wiring Diagram	Page 13
j) Wiring Diagram	Page 4	VII. TROUBLESHOOTING GUIDE	Page 14
k)Installing Optional Interior Kits	Page 4	VIII. SERVICE/WARRANTY INFORMATION	Page 15
IV. OPERATION	Page 5	a) Service Information	Page 15
a)Operation Display Indicators	Page 5	b) Spare Parts Information	Page 15
b) Refrigerators	Page 5	c) Warranty Registration	Page 15
c) Freezers	Page 5	d) Warranty Statement	Page 16
d) Light Switches	Page 5		
e) Loading Unit	Page 5		

I. THE SERIAL TAG





I. a - SERIAL TAG & LOCATION

The serial tag is a permanently affixed label on which is recorded vital electrical and refrigeration data about your Centerline product, as well as the model and serial number. This tag is located in upper right interior compartment on all reach-in refrigerator and freezer models.

I. b - READING THE SERIAL TAG

- **Model** = The model # of your Traulsen unit
- **(S/N) Serial Number** = The permanent ID# of your Traulsen unit
- **Refrigerant SYS1** = System 1 Refrigerant type used and refrigerant charge
- **Design Pressure** = System 1 High and Low Pressure
- **Refrigerant SYS2** = System 2 Refrigerant type used and refrigerant charge
- **Design Pressure** = System 2 High and Low Pressure
- **Volts** = Voltage
- **Hz** = Cycle
- **PH** = Phase
- **Total Current** = Maximum amp draw
- **Min Circuit Amps** = Minimum circuit ampacity
- **Lights** = Light wattage
- **Agency Labels** = Designates agency listings
- **Components** = Component Ratings



MODEL: MODELO: MODELE:	CLBM-23R-FS			 SCAN FOR SERVICE INFO
S/N:	T99999A99			
REFRIGERANT / REFRIGERANTE / RÉFRIGÉRANT				
SYS1 (REFM):	R-450A	14.00 oz	396.89 g	
Hi Press. (PRESH):	330 psi	2.28 MPa	(2,28 MPa)	
Lo Press. (PRESL):	150 psi	1.03 MPa	(1,03 MPa)	
SYS2 (REFA):				
Hi Press. (PRESH):				
Lo Press. (PRESL):				
Input Power (ELIN) - FOR INDOOR USE ONLY				
115 V	60 Hz	~	3.8 A	(3,80 A)
				
Intertek 5017388 CERTIFIED TO IEC 60335-1	Intertek 5017388 CONFORMES TO NBT / ANSI 574.7			
Device/Part Number:	Device/Part Notes:			
CLBM-23R-FS-L				
COMPONENTS / COMPOSANTS / COMPONENTES				
COMP AMPS:		LIGHT WATTS:	4	
COND FAN AMPS:		CTRL AMPS:		
DEF HTR AMPS:		B/TMCE HTR AMPS:		
DOOR HTR AMPS:		MIN CIRCUIT IN AMPS:		
EVAP FAN AMPS:		MAX OVR. CURRENT PROTECTION AMPS:		

370-60297-00 REV.B 11/21/14

II. RECEIPT INSPECTION

II. a - RECEIPT INSPECTION

All Centerline products are factory tested for performance and are free from defects when shipped. The utmost care has been taken in crating this product to protect against damage in transit. All interior fittings have been carefully secured and the casters/legs are boxed and strapped inside to prevent damage. Door keys will be attached to electric cord with nylon strip.

You should carefully inspect your Centerline unit for damage upon delivery. If damage is detected, you should save all the crating materials and make note on the carrier's Bill of Lading describing this. A freight claim should be filed immediately. If damage is subsequently noted during or immediately after installation, contact the respective carrier and file a freight claim. Under no condition may a damaged unit be returned to Traulsen without first obtaining written permission (return authorization). You may contact Traulsen customer care at (800) 333-7447 and select option 2 to request a return.

III. INSTALLATION

III. a - LOCATION

Select a proper location for your Centerline unit, away from extreme heat and allow proper clearance for air circulation. Allow enough clearance between the unit and the side wall in order to make use of the door stay open feature at 110° (self-closing feature operates up to 90°). The door(s) must be able to open a minimum of 90° in order to make use of the maximum clear door width available.

III. b - PACKAGING

All Centerline units are shipped from the factory bolted to a sturdy wooden pallet and packaged in a durable hexacomb cardboard panels.

Most exterior stainless steel and aluminum surfaces have a protective vinyl covering to prevent scratching during manufacturing, shipping and installation. After the unit is installed in place of service, remove and discard the covering from all surfaces.

If possible, we suggest that the cabinet remain bolted to the pallet during all transportation to the point of final installation. To remove the wooden pallet, the bolts can then be removed with a 3/4" socket wrench. Avoid laying the unit on its front, side or back for removal of the pallet.

NOTE: DO NOT LAY THE UNIT ON ITS SIDE DURING TRANSPORTATION OR INSTALLATION.

III. INSTALLATION (continued)

III. c - INSTALLING LEGS OR CASTERS

A set of four (4) 4" high casters are supplied standard for all Centerline Reach-In units. These are shipped from the factory packed inside a cardboard box which is strapped inside the cabinet to the lower shelf.

⚠ WARNING THE CABINET MUST BE BLOCKED AND STABLE BEFORE INSTALLING LEGS OR CASTERS.

The "Stem" casters are installed by threading them firmly into the cabinet bottom at each corner (see figure 1). For levelling, turn the casters counterclockwise to raise it, clockwise to lower it. Level the unit from front to back as well as side to side in this manner. The caster bolts are tightened using a 1/2" socket wrench.

Legs & 6" casters are available in lieu of 4" casters as an optional accessory kit for the same models. These are shipped inside a separate cardboard box containing four (4) casters/legs.

To install the legs or casters, first raise and block the reach-in a minimum of 7" from the floor. For installing legs, thread the legs into the threaded holes on the bottom of the cabinet (see figure 2). Be certain that all legs are tightly secured. When the unit is set in its final position, it is important for proper operation that the unit be level. The legs are adjustable for this purpose; turn the bottom of the leg counterclockwise to raise it, clockwise to lower it. Level the unit from front to back as well as side to side in this manner.

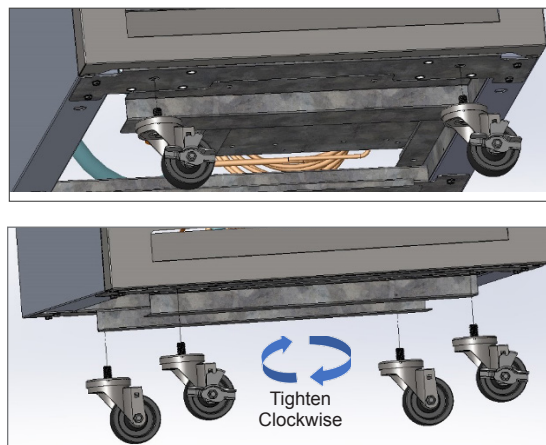

Fig. 1

III. INSTALLATION (continued)

III. c - INSTALLING LEGS OR CASTERS (cont'd)

Please note that Centerline units are not designed to be moved while on legs. If the unit requires moving, a pallet jack or fork- lift should be used to prevent damage.

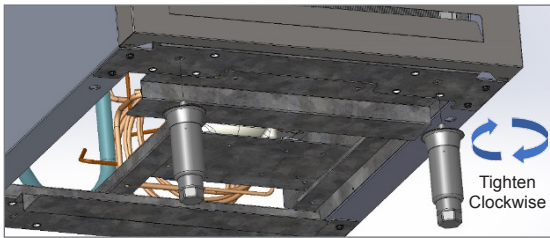
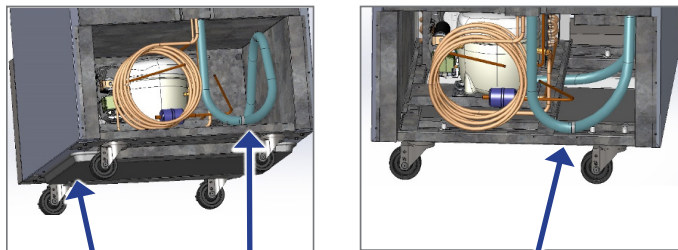

Fig. 2

III. d - INSTALLING DRAIN PAN

Centerline uprights are shipped with the drain pan wrapped up and stored inside the unit.

Remove the full-size sheet pan (drain pan) and slide it on the rails underneath the cabinet. Route the drain tubing through a bracket on the side wall to form a loop before dropping it into the drain pan. This will allow the water to drain into the pan.



Drain pan sits on rails under the unit

Routed Drain Tubing

Fig. 3

III. e - SHELVES

The unit is supplied with shelves and shelf clips to be installed on the pilasters. Check all shelf clips to assure they are firmly in place as they may have come loose during shipping. See section V.f for adjusting the shelves.

III. f - REMOVING DOORS & HARDWARE

In order to fit through narrow (less than 33.5") doorways, it may be necessary to remove the door(s), access panels and/or hinges. A Philip screwdriver may be required. First, unlock and open door to its open feature position about 110° and remove the screw holding each access panel (see figure 4 and figure 5).

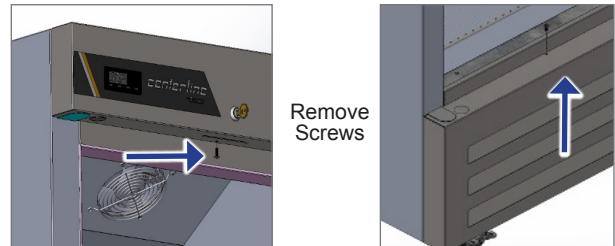

Remove Screws

Fig. 4

After removing the screws, the panels can be pulled off the pins to access hinge hardware. Set the top panel on top of the unit as it will have wiring still attached to the control display. The bottom panel of full door configuration can be set aside. Half door configuration bottom panel may have wiring attached to the door switch. If needed, the wiring connectors can be disconnected so louver can be set aside.

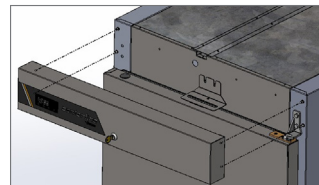

Pull panel corners off evenly; avoid pulling one corner at a time for easier removal.

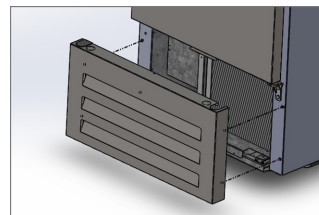

NOTE: Top/bottom louvers contain door switch for controlling interior lighting. Special care should be taken to prevent damaging the wiring during removal.

Fig. 5

After removing the panels, the hinge hardware can be accessed.

NOTE: ALWAYS SUPPORT THE DOOR WEIGHT OPPOSITE THE HINGE SIDE WHEN REMOVING TO PREVENT INJURY OR DAMAGE TO THE DOOR.

Remove the top & bottom hinge brackets from the unit. Remember to support the door weight opposite the hinge side.

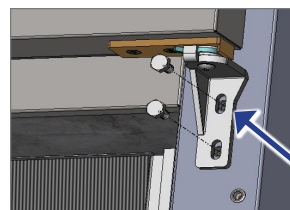

The bottom hinge plate bolts can be removed.

Fig. 6

III. INSTALLATION (continued)

III. f - REMOVING DOORS & HARDWARE (cont'd)

To remove the door, two bolts on the bottom hinge brackets need to be removed. Then remove two bolts on the top hinge bracket. The door can then be lifted from the unit.

Note that hinge brackets are under spring tension. Carefully move the door just far enough to allow the bracket to unwind.

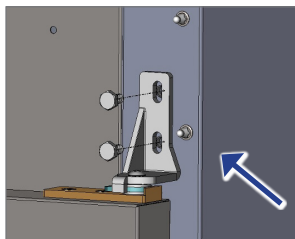

First, ensure the door weight opposite the hinge side is supported. The top hinge bracket bolts can be removed.

Fig. 7

To re-install the door, top and/or bottom louvers, and hinges, please reverse the appropriate sections of the preceding procedure.

III. g - DOOR REMOVAL FOR HALF DOOR UNITS

To begin, remove top/bottom panels, then open the door to its open feature position about 110°. For top door, remove two bolts on the top hinge bracket. The door can then be lifted up from the center hinge hardware. The plastic bushing will remain in the top door.

For bottom door: support the bottom door weight opposite the hinge side so minimum movement occurs when the bolts from the lower hinge plate are removed. Remove two bolts on the bottom hinge bracket. The door can then be moved down from the center hinge hardware. The plastic bushing will remain in the bottom door. Once top/bottom doors removed, two screws can then be removed on the center hinge.

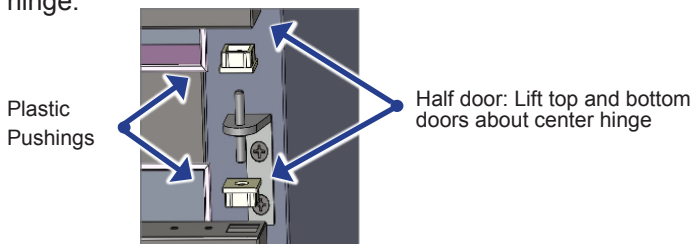

Fig. 8

Note that hinge brackets are under spring tension. Carefully move the door just far enough to allow the bracket to unwind.

III. h - CORD & PLUG

All Centerline reach-in models are supplied with a cord & plug attached. It is shipped coiled and secured by a nylon strip to the back of the cabinet near condensing unit area. For your safety and protection, all units supplied with a cord and plug include a special three-prong grounding plug on the service cord. Select only a dedicated electrical outlet with grounding plug for power source.

NOTE: DO NOT UNDER ANY CIRCUMSTANCES CUT OR REMOVE THE ROUND GROUNDING PRONG FROM THE PLUG OR USE AN EXTENSION CORD.

III. i - POWER SUPPLY

The supply voltage should be checked prior to connection to be certain that proper voltage for the cabinet wiring is available (refer to the serial tag to determine correct unit voltage). Make connections in accordance with local electrical codes. Use qualified electricians.

Use of a separate, dedicated circuit is required. Size wiring to handle indicated load and provide necessary over current protector in circuit (see amperage requirements on the unit's serial tag).

III. j - WIRING DIAGRAM

Refer to the wiring diagram located on the exterior back of the cabinet for any service work performed on the unit. Should you require one, please contact Traulsen Service at (800) 825-8220, and provide the model and serial number of the unit involved.

III. k - INSTALLING OPTIONAL INTERIOR KITS

In addition to their standard interiors, Centerline models also offer the option for additional shelves or tray slides. If ordered, these are shipped as kits along with the unit, packaged in a separate cardboard box which contains all the necessary parts and hardware for on-site installation.

To install additional shelves, install the included pins on the pre-cut holes where required. Secure the shelves to the pins using nylon tie-wraps.

Installation of optional tray slides varies with each cabinet, and with each type of tray slide ordered. To install optional tray slides, follow the directions packaged inside the kit carton.

IV. OPERATION

IV. OPERATION

Both refrigerators and freezers do not require manual defrosting. However, manual defrost option is available on the control, if required.

IV. a - OPERATION DISPLAY INDICATORS

During normal operation, the display shows either the temperature measured or one of the following indications:

dEF	Defrost in progress
oFF	Controller in stand-by
cL	Condenser clean warning
do	Door open alarm
E1	Probe T1 failure
E2	Probe T2 failure
E3	Probe T3 failure

IV. b - REFRIGERATORS

An off-cycle defrost happens every 6 hours for a maximum length of 30 minutes to melt any frost which may accumulate on the coil during the operation. During the Off-Cycle defrost, the compressor is off but the evaporator fans are turned on. The digital control will read “dEF” (see figure 10) during the defrost. When the temperature sensor affixed to the coil senses 44°F, the coil is fully defrosted and the compressor operation is resumed.

IV. c - FREEZERS

The coil requires a periodic defrosting for proper operation. This is accomplished by an automatic, time activated, temperature/time terminated, defrost program. The controller is preset at the factory for defrost cycles, approximately every 5 hours period.

The evaporator fan(s) cycle off with each door opening. The evaporator fan(s) will cycle on and off (during the compressor off cycle). During the compressor on cycle the evaporator fan(s) will run continuously. At the start of a freezer defrost cycle, both the compressor and evaporator fans are off. The digital control will read “dEF” (see figure 9).



Fig. 9

IV. c - FREEZERS (cont'd)

The electric heater (attached to the coil) is energized. When the temperature sensor affixed to the coil senses 44°F, the coil is fully defrosted and the compressor operation is resumed, defrost heaters are automatically turned off. The evaporator coil fans are delayed from starting at the termination of a defrost cycle. Fan operation is automatically resumed, after a short time or temp delay (whichever comes first). After completion, the total refrigeration system operation is then resumed. During defrost operation, heat is confined to the coil enclosure to prevent any significant rise in temperature within the food zone. The fan delay control function upon termination of a defrost cycle is two-fold. First, to prevent blowing warm air into the food storage area. Second, to prevent any condensation on the defrost coil from being blown into the food storage area.

IV. d - LIGHT SWITCHES

All Centerline models include a door switch mounted in the top, bottom, or both louvers depending on door configuration, which automatically activates the interior light when the door is opened. When the door is closed, the lights are automatically turned off.

In addition, on glass door models, lights are always illuminated whether the doors are open or not. It is possible to change this light feature to act only when door is open similar to solid doors if required. Please refer control section to change light function or contact Centerline Service department for step by step instructions.

IV. e - LOADING UNIT

Air circulation inside the unit is crucial for effective cooling and to maintain food safe temperatures. Air ducts, shelves, and fans are arranged to allow effective air circulation throughout the unit while allowing maximum food storage. See figure 10 and 11 for recommended cabinet loading while still maintaining effective air flow.

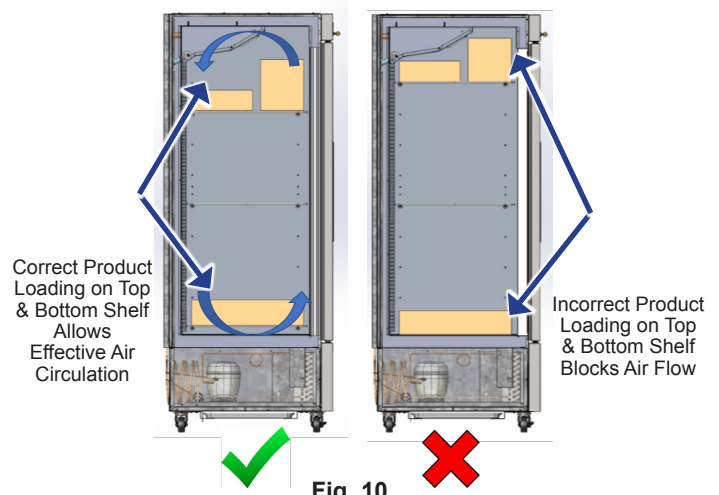

Fig. 10

IV. OPERATION (continued)

IV. e - LOADING THE UNIT (cont'd)

NOTE: BOTTOM SHELF SHOULD ALWAYS BE PRESENT DURING OPERATION TO MAINTAIN PROPER AIR CIRCULATION. FOOD SHOULD NOT BE LOADED DIRECTLY ON THE BASE OF THE CABINET. DOING SO MAY VOID THE WARRANTY OF THE CABINET.

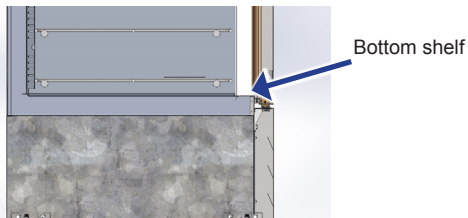

Fig. 11

V. CARE & MAINTENANCE

⚠ WARNING DISCONNECT ELECTRICAL POWER SUPPLY BEFORE CLEANING ANY PARTS OF THE UNIT.

V. a - CLEANING THE CONDENSER

The most important thing you can do to ensure a long, reliable service life for your Centerline is to regularly clean the condenser coil.

The condensing unit requires regularly scheduled cleaning to keep the finned condenser clean of lint and dust accumulation. Keeping the condenser clean allows the cabinet to operate more efficiently and use less energy. To clean the condenser, first disconnect electrical power to the cabinet.

Next, remove the front lower louver panel by removing the single screw from inside the door opening and gently pulling it towards front (refer to previous figures 4 and 5).

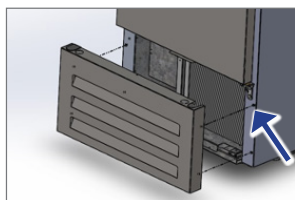

Remove single screw (seen in figure 4 and 5) and pull lower panel off to clean the condenser coil.

Fig. 12

NOTE: DOOR SWITCH WIRING MAY BE PRESENT AND ATTACHED TO THE LOUVER.

Vacuum or brush any dirt, lint or dust from the finned condenser coil, the compressor and other cooling system parts. If significant dirt is clogging the condenser fins, use compressed air to blow this clear. Care should be taken not to bend any of the condenser fins, as this will reduce performance and compressor life. Reverse the process to install louver assembly back in place.

V. CARE AND MAINTENANCE (continued)

V. b - HINGE REPLACEMENT

To replace the hinge, the upper and lower panels need to be removed from the face of the unit. The hinges can be removed as described in section III.f for door installation. Refer to section III.f for instructions to remove, install, and adjust torque on doors when replacing a hinge. Please refer service manual or contact service support for detailed instructions on hinge replacement

V. c - REPLACING THE GASKETS

To replace the gasket, grasp it firmly by one corner and pull it out. Before attempting to install a new gasket, both the unit and gasket must be at room temperature. Insert the four corners first by using a rubber mallet (or hammer with a block of wood). After the corners are properly inserted, work your way towards the center from both ends by gently hitting with a mallet until the gasket is completely seated in place (see figure 13 for proper gasket placement).

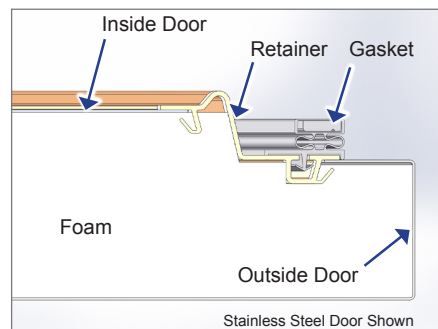

Fig. 13

V. d - CLEANING THE EXTERIOR

Exterior anodized aluminum should be cleaned with warm water, mild soap and a soft cloth. Apply with a dampened cloth and wipe in the direction of the metal grain.

Avoid the use of strong detergents and gritty, abrasive cleaners as they may tend to mar and scratch the surface. Do NOT use cleaners containing chlorine, this may promote corrosion of the stainless-steel door.

Care should also be taken to avoid splashing the unit with water, containing chlorinated cleansers, when mopping the floor around the unit.

For stubborn odor spills, use baking soda and water (mixed to a 1 TBSP baking soda to 1-pint water ratio).

V. e - CLEANING THE INTERIOR

For cleaning the interior, use baking soda with warm water, and a soft cloth. Apply with a dampened cloth and wipe in the direction of the metal grain Use on breaker strips as well as door and drawer gaskets.

V. CARE AND MAINTENANCE (continued)

V. f - ADJUSTING THE SHELVES

Shelves and pins are shipped with the unit. First, select the desired location and remove the white plastic covers in the interior back and/or interior sides by rotating them. Install pins in the new desired location (turn clockwise to tighten). Make sure the pins are securely tightened. Slide the shelf on the pins as shown below & secure it to the pins using nylon tie-wraps. Replace the white plastic covers in the open holes from where the pins were removed.

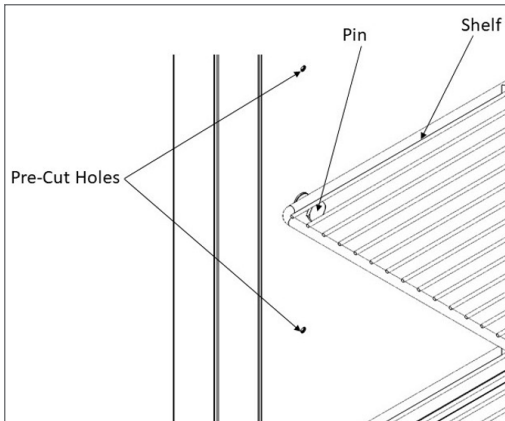

Fig. 14

VI. CONTROL BASICS

Your new Centerline Refrigerator or Freezer is equipped with a digital control, which precisely regulates operation. It is supplied from the factory completely ready for use.



VI. a - INFORMATION MENU

The information available in this menu is:

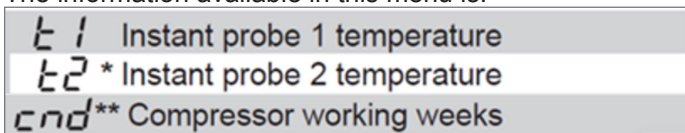

* displayed only if enabled (see Configuration Parameters)

** displayed only if ACC > 0

Access to menu and information displayed:

- Press and immediately release button **i**.
- With button **▼** or **▲** select the data to be displayed.
- Press button **i** to display value.
- To exit from the menu, press button **X** or wait for 10 seconds.

VI. CONTROL BASICS

VI. a - INFORMATION MENU (cont'd)

Initiate Stand-By:

Keeping the button **⏻** pressed for 3 seconds allows the controller to be put on a standby or output control to be resumed (with **SB**=YES only).

Locking the Keypad:

The keypad lock avoids undesired, potentially dangerous operations, which might be attempted when the controller is operating in a public place. In the INFO menu, set parameter **LOC** = YES to inhibit all functions of the buttons. To resume normal operation of keypad, adjust setting so that **LOC** = NO.

VI. b - ADJUSTING CABINET SETPOINT

Setpoint display and modification:

- Press button **i** for at least a half second to display the setpoint value.
- While keeping the **i** button pressed, use button **▼** or **▲** to set the desired value (adjustment is within the minimum **SPL** and the maximum **SPH** limit).
- When button **i** is released, the new value is stored.

VI. c - INITIATING A DEFROST

Automatic defrost:

Defrost starts automatically as soon as the time set with parameter **DFT** has elapsed.

- Timed defrost: With **DFM** = TIM defrosts take place at regular intervals when the timer reaches the value of **DFT**. For example, with **DFM** = TIM and **DFT** = 36, a defrost will take place every 6 hours.
- Optimized defrost: With **DFM** = FRO the timer is only increased when the conditions occur for frost to form on the evaporator, until the time set with parameter **DFT** is matched. If the evaporator works at 0°F, defrost frequency depends on the thermal load and climatic conditions. With setpoints much lower than 0°F, defrost frequency mainly depends on the refrigerator operating time.
- Defrost time count backup: At the power-up, if **DFB** = YES, the defrost timer resumes the time count from where it was left off before the power interruption. Vice versa, with **DFB** = NO, the time count re-starts from 0. In stand-by, the accumulated time count is frozen.

VI. CONTROL BASICS (continued)

VI. c - INITIATING A DEFROST (cont'd)

Manual or remote defrost start:

It's possible to manually start a defrost, by pressing button  for 2 seconds.

Defrost type. Once defrost has started, Compressor and Defrost outputs are controlled according to parameter **DTY**. If **FID** = YES, the evaporator fans are active during defrost.

Defrost termination. The actual defrost duration is influenced by a series of parameters.

- Time termination: **T2** = NO and **T3** different from 2EU: the evaporator temperature is not monitored and defrost will last as long as time **DTO**.
- Temperature monitoring of one evaporator: **T2** = YES and **T3** different from 2EU. In this case, if the sensor **T2** measures the temperature **DLI** before the time **DTO** elapses, defrost will be terminated in advance.











Resuming thermostatic cycle:

When defrost is over, if **DRN** is greater than 0, all outputs will remain off for **DRN** minutes, in order for the ice to melt completely and the resulting water to drain. Moreover, if probe **T2** is active (**T2** = YES), the fans will re-start when the evaporator gets to a temperature lower than **FDD**; Vice versa, if probe **T2** is not active (**T2** = NO) or after defrost has come to an end, such condition does not occur by end of the time **FTO**, after **FTO** minutes have elapsed the fans will be switched on anyway.

Caution: if **DFM** = NON or **C-H** = HEA all defrost functions are inhibited; if **DFT** = 0, automatic defrost functions are excluded.

VI. d - CONFIGURATION PARAMETERS

Parameter Configuration:

- To get access to the parameter configuration menu, press button  and  for 5 seconds.
- With button  or  select the parameter to be modified.
- Press button  to display the value.
- By keeping button  pressed, use button  or  to set the desired value.
- When button  is released, the newly programmed value is stored and the following parameter is displayed.
- To exit from the setup, press button  or wait for 30 seconds.

VI. e - TECHNICAL DATA

Power supply

TRL-002...W 100-240Vac ±10%, 50/60Hz, 3W

Relay output max loads (240Vac)

	TRL-002..S/T..-	TRL-002..Q/R..-
Compressor	16A resistive 12 FLA 48 RLA	12A resistive 12 FLA 48 RLA
Evap. Fan	16A resistive 4 FLA 12 RLA	8A resistive 4 FLA 12 RLA
Defrost	16A resistive 4 FLA 12 RLA	16A resistive 4 FLA 12 RLA
Auxiliary loads 1	7A resistive	7A resistive
Auxiliary loads 2	7A resistive	7A resistive

Input

NTC 10KΩ@25°C LAE Part No. SN4...

Measurement Range

<0.5 within the measurement range

Operating Conditions

-10... +50°C; 15%...80% r.H.

CE (Approvals and Reference Norms)

EN60730-1; EN60730-2-9; EN55022 (Class B); EN50082-1

VI. CONTROL BASICS (continued)

PAR	RANGE	DESCRIPTION
SPL	-58..SPH	Minimum limit for SP setting.
SPH	SPL...180°	Maximum limit for SP setting.
SP	SPL... SPH	Setpoint (value to be maintained in the room).
C-H	REF; HEA	Refrigerating (REF) or Heating (HEA) control mode.
HY0	1...10°	Thermostat OFF -> ON differential.
HY1	0...10°	Thermostat ON -> OFF differential.
CRT	0...30min	Compressor rest time. The output is switched on again after CRT minutes have elapsed since the previous switchover. We recommend to set CRT=03 with HY0<2.0°.
CT1	0...30min	Compressor/Heater output run when probe T1 is faulty. With CT1=0 the output will always remain OFF.
CT2	0...30min	Compressor/Heater output stop when probe T1 is faulty. With CT2=0 and CT1>0 the output will always be ON. Example: CT1=4, CT2= 6: In case of probe T1 failure, the compressor will cycle 4 minutes ON and 6 minutes OFF.
DFM	NON; TIM; FRO CRN	Defrost start mode NON : defrost function is disabled (the following parameter will be FCM). TIM : regular time defrost. FRO : the defrost time count is only increased when the conditions occur for frost to form on the evaporator (optimized time increase). CRN : defrost is based off of compressor run time (time is based off of DAT).
DFT	0...250	Time interval among defrosts in x10 minutes. When this time has elapsed since the last defrost, a new defrost cycle is started. Each number is multiplied by 10 minutes. 0-250 indicates 0-2500 minutes.
DAT	0...100 hours	Frost accumulation timeout.
DFB	NO/YES	Defrost timer backup. With DFB=YES, after a power interruption, the timer resumes the count from where it was left off with ±30 min. approximation. With DFB=NO, after a power interruption, the defrost timer will re-start to count from zero.
DLI	-58...180°	Defrost end temperature.
DMD	0...30min	Minimum defrost duration.
DTO	1...120min	Maximum defrost duration.
DTY	OFF; ELE; GAS	Defrost type OFF: off cycle defrost (Compressor and Heater OFF). ELE: electric defrost (Compressor OFF and Heater ON). GAS: hot gas defrost (Compressor and Heater ON).
DSO	OFF; LO; HI	Defrost start optimization OFF : no optimization. LO : defrost waits until the compressor cut-out. HI : defrost waits until the compressor cut-in.
SOD	0...30 min	Start optimization delay.
DPD	0...240sec	Evaporator pump down. At the beginning of defrost, defrost outputs (determined by DTY) are OFF for DPD seconds.
DRN	0...30min	Pause after defrost (evaporator drain down time).

VI. CONTROL BASICS (continued)

PAR	RANGE	DESCRIPTION
DDM	RT; LT; SP; DEF	Defrost display mode. During defrost the display will show: RT : the real temperature; LT : the last temperature before defrost; SP : the current setpoint value; DEF : "dEF".
DDY	0...60min	Display delay. The display shows the information selected with parameter DDM during defrost and for DDY minutes after defrost termination.
FID	NO/YES	Fans active during defrost.
FDD	-58...180°	Evaporator fan re-start temperature after defrost.
FTO	0...120min	Maximum evaporator fan stop after defrost.
FCM	NON; TMP; TIM	Fan mode during thermostatic control. NON : The fans remain ON all the time; TMP : Temperature-based control. The fans are ON when the compressor is ON. When the compressor is turned OFF, the fans remain ON as long as the temperature difference $T_e - T_a$ is greater than FDT. The fans are turned ON again with FDH differential. (T_e = Evaporator temperature, T_a = Air temperature); TIM : Timed-based control. The fans are ON when the compressor is ON. When the compressor is OFF, the fans switch ON and OFF according to parameters FT1, FT2, FT3
FDT	-12...0°	Evaporator-Air temperature difference for the fans to turn OFF after the compressor has stopped.
FDH	1...12°	Temperature differential for fan re-start. Example: FDT = -1, FDH=3. In this case, after the compressor has stopped, the fans are OFF when $T_e > T_a - 1$ (FDT), whereas the fans are ON when $T_e < T_a - 4$ (FDT-FDH).
FT1	0...180sec	Fan stop delay after compressor/heater stop. See Fig. 2
FT2	0...180	Timed fan stop in x10 seconds. With FT2=0 the fans remain on all the time.
FT3	0...180	Timed fan run in x10 seconds. With FT3=0, and FT2 > 0, the fans remain off all the time.
ATM	NON; ABS; REL	Alarm threshold management. NON : all temperature alarms are inhibited (the following parameter will be ACC). ABS : the values programmed in ALA and AHA represent the real alarm thresholds. REL : the alarm threshold is obtained by the sum of setpoint, thermostat differential and ALR/AHR.
ALA	-58... 180°	Low temperature alarm threshold.
AHA	-58... 180°	High temperature alarm threshold.
ALR	-12... 0°	Low temperature alarm differential. With ALR=0 the low temperature alarm is excluded.
AHR	0... 12°	High temperature alarm differential. With AHR=0 the high temperature alarm is excluded.
ATI	T1; T2; T3	Probe used for temperature alarm detection.
ATD	0... 120 min	Delay before alarm temperature warning.
ACC	0...52 weeks	Condenser periodic cleaning. When the compressor operation time, expressed in weeks, matches the ACC value programmed, "CL" flashes in the display. With ACC=0 the condenser cleaning warning is disabled and CND disappears from Info Menu.
IISM	NON; MAN; ECO; DI	Switchover mode to second parameter set NON : inhibition to use the second parameter group (the following parameter will be SB). MAN : button switches the two parameter groups over. ECO : automatic switchover to the second parameter group, when ECO conditions are detected. DI : switchover to the second parameter group when DIx input is on.
IISL	-58... IISH	Minimum limit for IISP setting.
IISH	IISL... 180°	Maximum limit for IISP setting.
IISP	IISL... IISH	Setpoint in mode 2.
IIHO	1... 10°	Thermostat OFF->ON differential in mode 2.

VI. CONTROL BASICS (continued)

PAR	RANGE	DESCRIPTION
IIH1	0... 10°	Thermostat ON->OFF differential in mode 2.
IIDF	0...250	Time interval among defrosts in mode 2 in x10 minutes.
IIFC	NON; TMP; TIM	Fan control in mode 2. See FCM.
ECS	1...5	Controller sensitivity for the automatic switchover from Group I to Group II (1=minimum, 5=maximum).
ECS	1...5	Controller sensitivity for the automatic switchover.
EPT	0...240 min	Eco pull-down time. Only with IISM=ECO. Group I parameters are used in regulation for at least EPT minutes. See Fig.3
SB	NO/YES	Stand-by button enabling.
DSM	NON; ALR; STP	Door switch input mode: NON : door switch inhibited ALR : when DIx=DOR and the digital input is on, an alarm is generated after ADO minutes STP : when DIx=DOR and the digital input is on, in addition to the alarm, the fans are immediately stopped and the compressor is stopped after CSD minutes.
DAD	0...30 min	Delay before door open alarm warning.
CSD	0...30 min	Compressor/heater stop delay after door has been opened.
D10	NON; DOR; ALR; IISM; RDS	DI1 digital input operation NON : digital input 1 not active. DOR : door input. ALR : when the input is on, an alarm is generated (if AHM=STP, the compressor is stopped and the defrosts are suspended). IISM : when the input is on, the controller will use group 2 parameters. RDS : when the input is on, a defrost is started (remote control).
D1A	OPN; CLS.	DI1 digital input activation. OPN : on open CLS : on close
D20	See D10	DI2 digital input operation. See D10.
D2A	OPN; CLS.	DI2 digital input activation. OPN : on open CLS : on close
PSL	-58...158	Minimum setpoint adjusted via potentiometer.
PSR	0...15	Range of setpoint adjusted via potentiometer.
LSM	NON; MAN; ECO; DI1; DI2; DI3.	Light control mode NON : light output not controlled. MAN : light output controlled through button (if OAx=LGT). ECO : lights activated/deactivated following the ECO state. DIx : lights activated/deactivated following the DIx state.
LSA	OPN; CLS	Light activation (only with LSM=ECO or LSM=DIx). OPN : lights on with DIx open or ECO mode deactivated. CLS : lights on with DIx closed or ECO mode activated.
OT1	0...600 sec	Activation time of OA1
OT2	0...600 sec	Pause between OA1 activation

VI. CONTROL BASICS (continued)

PAR	RANGE	DESCRIPTION
OA1	NON; LGT; 0-1; 2CU; 2EU; ALO; ALC	AUX 1 output operation NON : output disabled (always off). LGT : output enabled for light control. 0-1 : the relay contacts follow the on/standby state of controller. 2CU : output programmed for the control of an auxiliary compressor. 2EU : output enabled for the control of the electrical defrost of a second evaporator. ALO : contacts open when an alarm condition occurs. ALC : contacts make when an alarm condition occurs.
2CD	0...120 sec	Auxiliary compressor start delay. If OAx=2CU the auxiliary output is switched on with a delay of 2CD seconds after the main compressor has cut-in. Both compressors are turned off at the same time.
OS1	-12.5..12.5°	Probe T1 offset.
T2	NO/YES	Probe T2 enabling (evaporator).
OS2	-12.5..12.5°	Probe T2 offset.
T3	NON; DSP; CND; 2EU	Auxiliary probe T3 operation NON : probe T3 not fitted. DSP : temperature T3 to be displayed. CND : condenser temperature measurement. 2EU : second evaporator temperature measurement.
OS3	-12.5..12.5°	Probe 3 offset.
AHM	NON; ALR; STP;	Operation in case of high condenser alarm NON : high condenser alarm inhibited. ALR : in case of alarm, "HC" flashes in the display and the buzzer is switched on. STP : in addition to the alarm symbols displayed, the compressor is stopped and defrosts are suspended.
AHT	-50...110°	Condensation temperature alarm (referred to T3 probe).
TLD	1...30 min	Delay for minimum temperature (TLO) and maximum temperature (THI) logging.
TDS	T1; 1-2; T3	Selects the temperature probe to be displayed. T1 : probe T1 1-2 : the AVG-weighted average between T1 and T2 T3 : probe T3
AVG	0...100%	The relative weight of T2 on T1 (if TDS = 1-2) Example 1: T1 = -5°, T2 = -20°, AVG = 100%. The displayed temperature will be -20° (T1 has no effect) Example 2: T1 = -5°, T2 = -20°, AVG = 60%. The displayed temperature will be -14.
SCL	1°C; 2°C; °F	Readout scale. 1°C : measuring range -50...110°C (0.1°C resolution within -9.9 ÷ 19.9°C interval, 1°C outside) 2°C : measuring range -50 ... 110°C °F : measuring range -55 ... 180°F
SIM	0...100	Display slowdown.
ADR	1...255	TRL-002 address for PC communication.
NPR	0...1	Setup programmed.
STT	0...255	Setup traceability.

VI. CONTROL BASICS (continued)

VI. f - COMPONENTS AND WIRING DIAGRAM



Indications:

 Thermostat output

 Fan output

 Defrost output

 Activation of 2nd parameter set

 Alarm

 Manual activation / Increase button

 Exit / Stand-by button

Control Wiring Diagram:

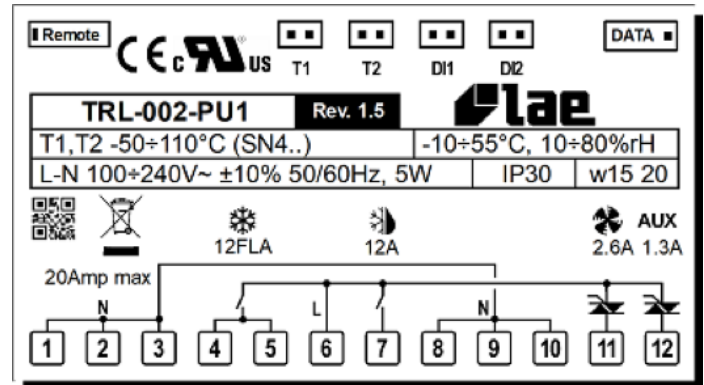

VII. TROUBLESHOOTING GUIDE

VII. a -TROUBLESHOOTING GUIDE

FIND YOUR PROBLEM HERE	REMEDY
1. Condensing unit fails to start.	<ul style="list-style-type: none"> a. Check if cord & plug has been disconnected. b. Check control temperature setting.
2. Condensing unit operates for prolonged periods or continuously.	<ul style="list-style-type: none"> a. Are doors closing properly? b. Dirty condenser or filter. Clean properly. c. Evaporator coil iced. Needs to defrost. See instructions for setting a manual defrost cycle on section VI.c.
3. Food compartment is too warm.	<ul style="list-style-type: none"> a. Check door(s) and gasket(s) for proper seal b. Perhaps a large quantity of warm food has recently been added or the door was kept open for a long period of time, in both cases, allow adequate time for the cabinet to recover its normal operating temperature. c. Control setting too high, readjust per instructions on section VI.b. d. Check that condensing coil is clean. e. Ensure the product is properly loaded and is not blocking the air flow, see section IV.e.
4. Food compartment is too cold.	<ul style="list-style-type: none"> a. Perhaps a large quantity of very cold or frozen food has recently been added. Allow adequate time for the cabinet to recover its normal operating temperature. b. Adjust the control to a warmer setting, see section VI.b.
5. Condensation on the exterior surface.	<ul style="list-style-type: none"> a. Check door alignment and gaskets for proper seal. b. Condensation on the exterior surface of the unit is perfectly normal during periods of high humidity.
6. Compressor hums but does not start.	<ul style="list-style-type: none"> a. Call for service.
7. No power to unit	<ul style="list-style-type: none"> a. Check if cord & plug has been disconnected. b. Check power supply breaker.

VIII. SERVICE/WARRANTY INFORMATION

VIII. a - SERVICE INFORMATION

Before calling for service, please check the following:

- Is the electrical cord plugged in?
- Is the fuse OK or circuit breaker on?
- Is the condenser coil clean?
- Is the power switch on?

If after checking the above items and the unit is still not operating properly, please contact an authorized Centerline by Traulsen service agent:

4401 Blue Mound Road Fort Worth, TX 76106
(800) 825-8220.

Centerline by Traulsen reserves the right to change specifications or discontinue models without notice.

VIII. b - SPARE PARTS INFORMATION

To purchase replacement parts or to speak to service support for Centerline by Traulsen units please contact our Ft. Worth facility by phone at 800-825-8220 or fax to 817-740-6748 (parts) or 817-740-6757 (service).

Note: When calling for spare parts or service support, please make sure you have model and serial number of unit available.

TRAULSEN
4401 Blue Mound Rd.
Fort Worth, TX 76106
800-825-8220

MODEL NUMBER: 102120041-010
SERIAL NUMBER: 101000010

REFRIGERANT / REFRIGERANTS / REFRIGERANT

REFRIGERANT	R-134a	6.8oz	2.06 kg (4.54 lb)
REFRIGERANT	R-134a	6.8oz	2.06 kg (4.54 lb)
REFRIGERANT	R-134a	6.8oz	2.06 kg (4.54 lb)
REFRIGERANT	R-134a	6.8oz	2.06 kg (4.54 lb)

REPAIR POWER (WATT) - FOR WINDON USE ONLY
USE ONLY FOR WINDON USE ONLY

Symbol 1 (Fan Safety / Other 1)	Symbol 2 (Alt. Gas / Other 2)	Symbol 3 (Alt. Cr. / Other 3)	Symbol 4 (Other 4)
Symbol 5 (Other 5)	Symbol 6 (Other 6)	Symbol 7 (Other 7)	Symbol 8 (Compressor Oil Code / Other 8)

Refrigerant Number (Refrigerant) (01,000) (None)

COMPONENTS / COMPONENTS / COMPONENTS

COMP AMP:	COMP FAN AMP:
COND FAN AMP:	LIGHT WATT:
DEF FAN AMP:	DEF AMP:
DOOR WTR AMP:	DEF AMP:
HEAT AMP:	

800-825-8220

VIII. c - WARRANTY REGISTRATION:

The warranties for your new Traulsen unit may be registered with us by by completing warranty information online, via our website www.CenterlineFoodEquipment.com. Click on the Product Registration text at the footer of the home page. You may also register your product by calling us directly at 800-825-8220.

VIII. SERVICE/WARRANTY INFORMATION (continued)

VIII. d - WARRANTY STATEMENT:



TRAULSEN EQUIPMENT WARRANTY



U.S. Domestic Warranty

For sales of Traulsen refrigeration equipment (“Equipment”) within the United States, Traulsen warrants to the original purchaser of the Equipment (“Purchaser”) that Traulsen will convey the Equipment free and clear of all liens, security interests, and encumbrances created by, through or under Traulsen. Traulsen further warrants that for a period of three (3) years from the later of either (a) the date of delivery to the common carrier or (b) the date of installation (the “Domestic Warranty Period”) but in no event, shall the Domestic Warranty Period commence later than 3 months from the date of delivery to the common carrier unless otherwise agreed upon by the parties in writing, under normal use and given proper installation and maintenance as determined by Traulsen, the Equipment: (a) will conform to the specifications as provided by Traulsen (“Specifications”) and (b) will be free from substantial defects in material and workmanship.

The warranty period for compressors shall extend for an additional two (2) years beyond the Domestic Warranty Period. In the case of a nonconforming compressor, Traulsen shall provide a replacement compressor; however, all installation, recharging, and repair costs shall be the responsibility of Purchaser. In the case of a nonconforming part, Purchaser must return the part to Traulsen within 30 days from the date of repair. Failure to return a claimed defective part to Traulsen within the 30 days will waive the right to the warranty claim.

Additionally, Traulsen provides a lifetime warranty on the housing of cam-lift hinges and the workflow handles. In the case of a non-conforming housing for cam-lift hinge or workflow handle, Traulsen shall provide a replacement part; however, Purchaser shall be responsible for any other replacement costs, including but not limited to installation and labor.

The Domestic Warranty does not apply to: (a) consumable components or ordinary wear items; (b) components that are removable without the use of tools including but not limited to gaskets, shelf pins, and light bulbs; (c) use of the Equipment components or parts not supplied by Traulsen or specified by Traulsen in the Operator’s Manual as set forth on Traulsen’s website; or (d) damage resulting from fire, water, burglary, accident, abuse, misuse, transit, acts of God, terrorism, power surges, improper installation, or repairs or installation by unauthorized third parties. Additionally, the Equipment is intended only for commercial use and should not be used by consumers or households or in any non-commercial application. This Domestic Warranty does not apply to, and shall not cover, any Equipment that is installed or used in any way in any residential or non-commercial application. No warranties, express or implied, are provided to any residential, consumer or non-commercial purchaser or owner of the Equipment.

For Traulsen units purchased for use with a condenser provided by a third-party, this standard warranty will apply only to those components contained within the unit to the point of connection of the refrigeration lines leading to the third-party condenser.

In the event of a breach of the warranties set forth above (the “Domestic Warranty”), Traulsen will, at Traulsen’s option and as Purchaser’s sole remedy, repair or replace, including labor costs, any nonconforming Equipment, provided that (a) during the Warranty Period Traulsen is promptly notified in writing upon discovery of the nonconformance with a detailed explanation of any alleged deficiencies; (b) Traulsen is given a reasonable opportunity to investigate all claims; and (c) Traulsen’s examination of any alleged defective part confirms such alleged deficiencies and that the deficiencies were not caused by misuse, neglect, improper installation, unauthorized alteration or repair or improper testing. Traulsen reserves the right to, at its request, require Purchaser shall ship the alleged defective part to Traulsen for inspection and confirmation of defect. No Equipment may be returned without Traulsen’s approval.

Purchaser is solely responsible for determining if Equipment is fit for a particular purpose and suitable for Purchaser’s application. Accordingly, and due to the nature and manner of Traulsen’s Equipment, Traulsen is not responsible for the results or consequences of use, misuse, or application of its Equipment.

THIS DOMESTIC WARRANTY SETS FORTH THE EXTENT OF TRAULSEN’S LIABILITY FOR SALES WITHIN THE UNITED STATES. EXCEPT AS SET FORTH ABOVE, TRAULSEN MAKES NO WARRANTY OR REPRESENTATION OF ANY KIND, EXPRESS OR IMPLIED (INCLUDING NO WARRANTY OF MERCHANTABILITY OR FITNESS FOR ANY PARTICULAR PURPOSE). IN NO EVENT WILL TRAULSEN’S LIABILITY IN CONNECTION WITH THE AGREEMENT OR SALE OF THE EQUIPMENT EXCEED THE PURCHASE PRICE OF THE EQUIPMENT AS TO WHICH THE CLAIM IS MADE. IN NO EVENT SHALL TRAULSEN BE LIABLE FOR ANY LOSS OF USE, LOSS OF PRODUCT, LOSS OF PROFIT, OR ANY OTHER INDIRECT, INCIDENTAL, SPECIAL, OR CONSEQUENTIAL DAMAGES RESULTING FROM THIS WARRANTY EVEN IF TRAULSEN HAS BEEN NOTIFIED OF THE POSSIBILITY OF SUCH DAMAGES.



TRAULSEN
4401 BLUE MOUND RD.
PHONE 1 (800) 825-8220
Website: www.traulsen.com

FT. WORTH, TX 76106
FAX-MKTG. 1 (817) 624-4302



4401 Blue Mound Road Fort Worth, Texas 76106 (USA)

Phone: 800.825.8220 | Service Fax: 817.740.6757 | E-mail: service@traulsen.com | Website: centerlinefoodequipment.com

Form Number: TR36229 | Part Number: 375-60364-00 | Revision Date: 05-01-20

Traulsen © All Rights Reserved