

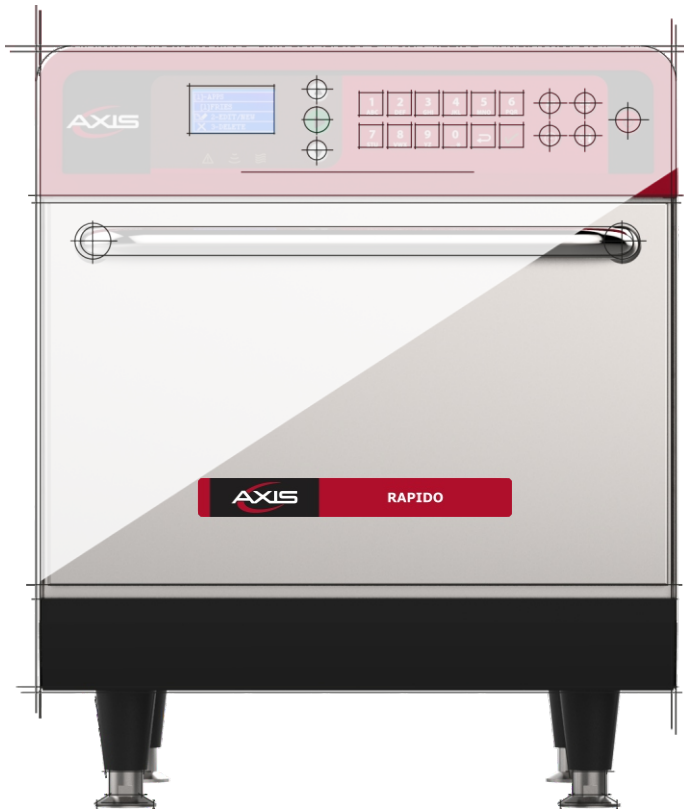

SPEED OVEN

# RAPIDO



**INSTALLATION AND OPERATION MANUAL**



## **LETTER TO CUSTOMERS**

MVP Group is proud to become part of your day-to-day lives with our products. By purchasing MVP Group equipments, you will have a partner always attentive to your needs and interested in keeping customers satisfied.

We are available to serve you at any time, whether it is to hear your ideas, criticisms, suggestions or to solve an issue.

**Count on us!**

### **Our Mission**

Bring quality and productivity to the food preparation environment.

### **Our Commitment**

- To know and meet the needs of our customers.
- Offer reliable, high-performance, and energy-efficient products.
- Always looking for improvements of processes, products and cost to offer more value to our customers every single day.
- Treat our customers with complete honesty and respect.
- MVP Group donates a portion of its profit to charitable causes.

*This manual contains all the information for you to install and use your equipment correctly and get the best performance results, with quality and safety.*

*We recommend you to read and follow all the guidelines contained therein and the always keep it in a suitable place for future consultations.*



# SUMMARY

## IMPORTANT SAFETY INSTRUCTIONS

Use Recommendations.....	08
Restrictions of use.....	11
General recommendations for cleaning.....	12
Safety risk: cleaning chemicals.....	12
Safety risk: heating.....	12
Safety risk: electric power.....	13
Suitable utensils.....	14
Combination of suitable utensils.....	14

## PRECAUTIONS TO AVOID POSSIBLE EXPOSURE TO EXCESSIVE MICROWAVE ENERGY.....

15

## IDENTIFICATION OF SYMBOLS USED IN THIS MANUAL.....

16

## WARRANTY TERM

Terms and detailing.....	17
Warranty exclusions.....	17
Notes and recommendations.....	18

## INSTALLATION INSTRUCTIONS

Electrical installation.....	19
General instructions.....	21
Dimensions.....	22
General recommendations.....	23

## RAPIDO TECHNOLOGY.....

24

## PRINCIPLES OF OPERATION.....

25

## RECIPES CREATION.....

27

## OPERATING INSTRUCTIONS

Preheating.....	28
Play recipes.....	28
Creating and editing groups.....	30
Creating, editing and deleting recipes.....	31
Manual Mode.....	33
Importing and exporting function.....	34
Cooling the oven.....	35
Temperature inspection.....	36
Information Led's.....	36

**CLEANING**

Procedure.....37  
Cleaning the catalytic converter.....38  
Cleaning the air filter.....39



# IMPORTANT SAFETY INSTRUCTIONS

## USE RECOMMENDATIONS

- Oven operation: It is recommended that the oven operator to always wear thermal protection gloves and an apron (PPE's) to prevent burns when in contact with the oven chamber and possible spillage of the contents of the trays.
- Use of the panel: The panel must be operated with fingers only, the use of any instrument may damage the equipment and jeopardize the operator's safety.

**CAUTION:** To avoid burns, do not use containers with liquids or kitchen products that become liquids by heating up to a boiling point. **The oven must be mounted after the installation at 63in / 5ft / 1.6m above floor level.**



- **WARNING: The lack of kiln cleaning can cause surface deterioration and this can adversely affect the life of the equipment and possibly result in a dangerous situation.**
- Remove metal or plastic sealing wires of bags inserted in the unit. Check if the container used is under specification for temperature and microwaves provided by the unit. Do not use plastic utensils.
- Do not allow children to use or operate this equipment.
- Do not use the equipment if it is damaged, specially if its door is not closing properly.
- Do not place any object between the inner cavity and the oven door, obstructing the door from closing.
- Do not let the power cord hang over the edge of the table or counter.
- Only qualified personnel should open the equipment panel.
- Do not use plastic utensils.
- Do not use water jet for cleaning.
- Do not use steam cleaner for cleaning.
- Do not use the Microwave function without food as it can damage the equipment.



- Do not operate the equipment with the door open due to microwave energy exposure.
- Do not allow food residue or other debris to accumulate on the surface of the door and hinge to avoid damaging the equipment.
- Foods with skin, bark or membrane, such as tomato, potato, sausage, must be perforated with a fork as they may explode.
- Fully sealed packages should not be heated in the oven as they can explode.
- Do not cover or block any air vents on unit.
- Do not use the equipment outdoors or without coverage.
- Do not use this product near water such as near the kitchen sink, in a wet basement, or near a swimming pool.
- Do not use a water jet for cleaning the unit. Please see cleaning instructions for proper cleaning.
- When cleaning the oven surfaces use only non-abrasive products applied with a nylon sponge or soft cloth (**page 37**). **Note: Consult MVP Group to make sure the correct cleaning product is being used.**
- To reduce the risk of fire in the oven cavity: remove wires used to seal paper or plastic bags that will be into the oven.
- Carefully monitor the equipment when materials such as paper, plastic, and other combustible materials are placed inside the oven for easy cooking.
- Remove all contents located inside the oven cavity.
- If the product catches fire inside the cook cavity, close the door immediately and turn the unit off or unplug it. The power can also be turned off at the circuit breaker.
- Always wear thermal gloves or use holders or tongs to remove the food from inside the equipment to avoid burns.

- Do not use the cavity of the equipment for storage.
- When heating liquids using microwave only or combined function, the contents should be stirred before heating to help prevent eruptive boiling. In microwave beverage heating can result in delayed eruption, so care should be taken when handling the container.
- Liquids, such as water, coffee, or tea are able to be overheated beyond the boiling point without appearing to be boiling. Visible bubbling or boiling when the container is removed from the microwave oven is not always present. THIS COULD RESULT IN VERY HOT LIQUIDS SUDDENLY BOILING OVER WHEN THE CONTAINER IS DISTURBED OR A UTENSIL IS INSERTED INTO THE LIQUID.
- The minimum height of free space above the microwave should be of 5.9in (150mm).
- Only use utensils suitable for use in microwave ovens.
- When heating food in microwave safe container, check the oven frequently due to the possibility of ignition.
- The oven should be cleaned daily and any food remains must be removed.
- Failure to maintain the oven in a clean condition may lead to deterioration of the surface that could adversely affect the equipment service life and possibly result in the warranty loss.
- Do not operate any heating or cooking equipment beneath this product.
- Do not mount unit over or near any portion of a heating or cooking equipment.
- Do not mount over a sink.
- Oversized foods or oversized metal utensils should not be inserted in the oven as they may create a fire or risk of electric shock.
- Do not clean with metal scouring pads. Pieces may burn off the pad and touch electrical parts involving a risk of electric shock.

- Some products such as whole eggs and sealed containers – for example, closed glass jars – are able to explode and should not be heated in this oven.
- Do not use paper appliances when equipment is operated in the toaster mode.
- Do not store any materials, other than manufacturer's recommended accessories in this oven when not in use.
- Do not cover racks or any other part of the oven with metal foil. This will cause overheating of the oven.
- It is necessary to remove and clean the air filter frequently. For more details go to **page 38** of the manual.
- Daily cleaning is required to remove fat grease from equipment. For more details, see **page 37** of the manual.
- Clean Only Parts Listed in Manual. Other than that, please contact the manufacturer for instructions.
- Use this equipment only for the functions described in this manual.

## RESTRICTIONS OF USE

- **WARNING: Do not use corrosive chemicals or vapours in this device. This type of oven is specifically designed to heat, regenerate, gratin or finish food that has already undergone some cooking process. Not suitable for cooking food or products in general. It is not designed for industrial or laboratory use.**
- Use only utensils suitable for use in microwave combo ovens on **page 14**.
- Never use the device to heat alcohol, cognac, rum, etc.
- Alcohol can catch fire more easily if overheated. Be careful and do not leave the device unattended.

- If smoke is observed, turn off the device. Disconnect or isolate it from the power supply and keep the door closed to muffle the flames.

## GENERAL RECOMMENDATIONS FOR CLEANING

- The cooking chamber of the equipment must be cleaned daily. Failure to keep the equipment clean can lead to surface deterioration, which can adversely affect the life of the equipment and possibly result in a hazardous situation.
- The equipment shall be disconnected from the mains during maintenance and replacement of parts. It is not necessary to disconnect the equipment from the power supply during daily cleaning of the equipment.

## SAFETY RISK: CLEANING CHEMICALS

DANGER	WHERE OR IN WHAT SITUATIONS DOES DANGER ARISE?	PREVENTIVE ACTION
Risk of chemical burns or irritation of the skin, eyes and respiratory system due to contact with cleaning chemicals and their fumes.	For all cleaning actions.	<ul style="list-style-type: none"> <li>• Do not let cleaning chemicals come into contact with your skin or eyes.</li> <li>• Do not heat the equipment if there are cleaning chemicals inside.</li> <li>• Don't breathe in the chemical spray.</li> <li>• Use personal protective equipment (PPE's).</li> </ul>
	When corrosive cleaning chemicals are used.	<ul style="list-style-type: none"> <li>• Strictly follow the steps to cleaning page 37.</li> </ul>

## SAFETY RISK: HEATING

DANGER	WHERE OR IN WHAT SITUATIONS DOES DANGER ARISE?	PREVENTIVE ACTION
Risk of burns from hot surfaces.	Inside the entire cavity, including all parts that are or have been inside during cooking, such as: <ul style="list-style-type: none"> <li>• Racks;</li> <li>• Containers;</li> <li>• Baking sheets.</li> </ul>	<ul style="list-style-type: none"> <li>• Before starting cleaning tasks, wait until the cavity has cooled below 50°C (122°F).</li> </ul>
	Inside the equipment door.	Wear personal protective clothing and equipment (PPE's) as shown on page 08.

• **SAFETY RISK: ELECTRIC POWER**

DANGER	WHERE OR IN WHAT SITUATIONS DOES DANGER ARISE?	PREVENTIVE ACTION
Risk of electric shock by energized parts.	<ul style="list-style-type: none"> <li>• Under the covers;</li> <li>• on the operating panel;</li> <li>• Along the power cord.</li> </ul>	<ul style="list-style-type: none"> <li>• Work on the electrical system must be performed only by qualified electricians of an authorized service company.</li> <li>• Professional Work.</li> <li>• Make sure that all electrical connections are in perfect condition and securely fixed before putting the equipment into use.</li> </ul>
	In the equipment and adjacent metal parts.	<ul style="list-style-type: none"> <li>• Before preparing the equipment for use, make sure that the equipment is connected to a equipotential compensation system (UE).</li> </ul>
	If the equipments on wheeled supports start to move accidentally and the power supply is switched off.	<ul style="list-style-type: none"> <li>• When operating the equipments, always engage the safety lock on the wheels.</li> <li>• Check daily that the wheel locks are activated before starting the operation.</li> </ul>
Risk of electrical shock caused by a short circuit.	If the equipment comes into contact with water.	<ul style="list-style-type: none"> <li>• Do not wash the outer box with water.</li> <li>• Always keep the USB cover closed while cleaning.</li> </ul>

## SUITABLE UTENSILS

Check the manufacturer's instructions and temperature rating to determine the suitability of individual containers and accessories to be used with the furnace. The table below provides general guidelines:

SUITABLE KITCHEN UTENSILS	ALLOWED	PREVENTIVE ACTION
<b>HEAT-RESISTANT CONTAINERS</b>		
Tempered glass.	<b>YES</b>	
Compatible ceramics.		Do not use items with metallic decoration.
Earthenware (crocker, porcelain, etc.) Note: the level of mineral load present in the utensil can affect the performance of the equipment		
<b>METAL AND FOIL TRAYS</b>		
Any metal or foil containers	<b>NO</b>	
<b>PLASTIC CONTAINERS</b>		
Plastic containers	<b>NO</b>	
<b>DISPOSABLE</b>		
Fuels (paper, cardboard, etc.)	<b>YES</b>	Use only disposables compatible with the temperatures reached by the oven (280°C).
<b>OTHER UTENSILS</b>		
Tethers and labels	<b>NO</b>	During the cooking process no utensil such as probes, cutlery, straps and labels must be inside the oven.
Cutlery		
Temperature probes		

## COMBINATION OF SUITABLE UTENSILS

COMBINATION OF ACCESSORIES	ALLOWED	OCCURRENCE
Panini Style Grill Plate	<b>YES</b>	
Panini Style Grill Plate + Solid PTFE Basket	<b>YES</b>	
Panini Style Grill Plate + Aluminum Pan	<b>NO</b>	It affects the performance of the equipment and can damage the microwave system.
Aluminum Pan	<b>YES</b>	
Aluminum Pan + Solid PTFE Basket	<b>NO</b>	It affects the performance of the equipment, can damage the microwave system and can damage the teflón basket.
Teflon accessories	<b>YES</b>	

## USE RECOMMENDATIONS (continuation)

### CAUTION!

- The equipment is not intended for use by people (including children) with reduced physical, sensory or mental capabilities, or that have not been properly trained to operate the unit.



- Do not use the oven handle to move the equipment. The oven must be moved exclusively from its sides.



- Do not use the equipment door as support. It will cause unevenness of the door and equipment malfunction.



- The oven door is only intended for sealing microwaves generated during cooking. Using the door for any other purpose not described in this manual may void the warranty.

### PRECAUTIONS TO AVOID POSSIBLE EXPOSURE TO EXCESSIVE MICROWAVE ENERGY

- (a) Do not attempt to operate this oven with the door open since open-door operation can result in harmful exposure to microwave energy. It is important not to defeat or tamper the safety interlocks.
- (b) Do not place any object between the oven front face and the door or allow soil or cleaner residue to accumulate on sealing surfaces.
- (c) Do not operate the oven if it is damaged. It is particularly important that the oven door close properly and that there is no damage to the: (1) Door (bent), (2) Hinges and latches (broken or loosened), (3) Door seals and sealing surfaces.
- (d) The oven should not be adjusted or repaired by anyone except properly qualified service personnel.

## IDENTIFICATION OF SYMBOLS USED IN THIS MANUAL



**DANGER!** THREAT OF RISK THAT MAY CAUSE SERIOUS INJURY OR DEATH



**ALERT**



**WARNING - FIRE RISK** - TO REDUCE THE FIRE RISK DO NOT REMOVE THIS COVER. NO USER-SERVICEABLE PARTS INSIDE. REPAIR SHOULD BE DONE BY AUTHORIZED SERVICE PERSONNEL ONLY



**MICROWAVE WARNING SYMBOL:** THIS SYMBOL IDENTIFIES THERE IS A RISK OF EXTERNAL AND INTERNAL BURNS OF BODY PARTS FOLLOWING EXPOSURE TO MICROWAVE ENERGY.



**WARNING - RISK OF ELECTRIC SHOCK** - TO REDUCE THE RISK OF ELECTRIC SHOCK DO NOT REMOVE THIS COVER. NO USER-SERVICEABLE PARTS INSIDE. REPAIR SHOULD BE DONE BY AUTHORIZED SERVICE PERSONNEL ONLY



**WARNING - BURN RISK** - DO NOT TOUCH ANY PART WITH THIS SYMBOL WHILE THE OVEN IS IN OPERATION.



**WARNING - RISK OF BURN FROM SPILLING OF HOT LOAD** - TO AVOID BURNS, DO NOT USE CONTAINERS WITH LIQUIDS OR KITCHEN PRODUCTS THAT BECOME LIQUIDS BY HEATING UP TO A BOILING POINT.



**GROUNDING SYMBOL**



**EQUIPOTENTIAL SYMBOL**



**USE TIPS AND INFORMATION**



# WARRANTY TERM

## TERMS AND DETAILING

- a)** Our products are warrantied for twelve 12 months for parts and labor, and twenty-four months for the all heating element parts; from the date the product is installed. If, for any reason, there is no record of the installation date nor the purchase invoice is not found, the date of manufacture of the equipment contained on the indicative label will be considered the date of beginning of the applicability of this guarantee.
- b)** If new visits are needed to complete the delivery/installation of the product due to the lack of adequate, electrical, or exhaust related conditions, the costs of such visits shall be the customer's responsibility.
- c)** For the product's installation, the customer must provide all conditions required (208v/240v single phase) in the installation blueprint. The customer will also be responsible for transporting the equipment to the installation site.
- d)** The warranty only covers manufacturing and component failures. Damages caused by lack of heeding label warnings on the product will not be covered.
- e)** The warranty will cover adjustments and replacement of defective parts. It is the responsibility of the authorized service technician to return the defective parts to MVP Group for analysis when requested by the Manufacturer.
- f)** Warranty service calls will not justify the extent of the warranty, returns or exchanges of the equipment, or any other type of claim.

## WARRANTY EXCLUSIONS

- a)** The customer should thoroughly inspect the equipment upon delivery and contact the carrier in case of shipping damage arising from transport.
- b)** MVP Group will not respond for any issues arising for electrical building irregularities, or a lack of abiding to the local electrical code.
- c)** Use or installation not in accordance with the Installation and Operation Manual accompanying the product.

- d)** Failure to observe the installation details per the Installation and Operation Manual, such as uneven floors, installing the oven next to equipment that exudes fat, heat or solid particles, lack of air circulation, etc.
- e)** Any damage and defects resulting from inappropriate cleaning products that result in damages to the components will not be covered under warranty. For example, pouring water inside the electric panel, etc.
- f)** Changes performed by unauthorized technicians in the original conditions of installation such as electrical distribution, installation location, etc.
- g)** Use of aggressive or abrasive products that are unsuitable for cleaning which may tarnish, wear, scratch or damage accessories or equipment components.
- h)** Occurrences from electrical discharges arising from acts of nature or voltage peaks caused by generators or power supply companies.
- i)** Damage to the equipment or its accessories caused by accidents, improper operation, improper handling or installation as described by the Operation Manual included with this product.
- j)** Repair attempts by unauthorized third parties or use of non-OEM parts and components, regardless of the damage or defects.

## **NOTES AND RECOMMENDATIONS**

- a)** The operator should use the Installation and Operation Manual as a guide.
- b)** Make sure that the electric systems are made and installed by a qualified company or technician.
- c)** Before contacting technical assistance, check the manual for troubleshooting tips that can be solved without a technician.
- d)** For installation, service or other questions contact:

**TECH SUPPORT:**  
MON - FRI 8:30 AM - 5:00 PM EST  
(888) 275-4538 EXT 611  
**SERVICE@MVPGROUPCORP.COM**  
(888) 275-4538 EXT 612

## EQUIPMENT IDENTIFICATION

(Fill in to make technical support calls easier)



MODEL			
VOLTAGE		SERIAL NUMBER	
RESELLER			
INVOICE NUMBER		PURCHASE DATE	



## ELECTRICAL INSTALLATION

**Note:** The oven must be properly configured for optimum performance before using it for the first time. Follow the steps listed below to set the oven operating system to either 208V or 240V supply voltage based on the voltage being supplied at the oven's receptacle. This configuration step is only performed on the initial set-up and installation. The oven will not need to be configured again as long as the supply voltage remains unchanged.

1. Verify the supply voltage. If this knowledge is not readily available, please use a qualified technician or individual familiar and comfortable with electricity to take the measurements. Care must be used to avoid electrical shock. Confirm the electrical configuration of the receptacle conforms to the electrical specification in the table below and written on the oven's data plate located on the back of the unit.

2. Connect the oven to the power supply.

3. Press the  and the  simultaneously to enter the programming screen.

4. The display will show both voltages, use the  /  to highlight the correct choice for your application.

5. Press the  to set the correct voltage and save the settings.

6. Press the  to turn off the oven.

7. The oven is now ready for use, press the  to enter the warm-up mode.

# INSTALLATION INSTRUCTIONS

## ELECTRICAL INSTALLATION

- Always follow the installation instructions in the instruction manual or the product's spec sheet.
- The installation of the product must be done with the necessary care to avoid problems, damage to the equipment, and guarantee its full use.
- This equipment must be installed by an authorized technician.



- The equipment **MUST** be grounded.
- The oven must have a exclusive circuit breaker.
- Do not immerse the power cable or connect water to the unit.
- Keep the power cord away from heated surfaces.
- If the power cable is damaged, it must be immediately replaced by an authorized technician to avoid shock hazards.
- Only qualified personnel should open the equipment panel.
- There is an equipotential point on the rear panel of the oven.

Voltage (V)	Phases	Freq. (Hz)	Power (kW)	Circuit Breaker (A)	Cable	Socket	
208	Single	60	6.2	32	3x10AWG	NEMA 6-30	
240			7.2				

## INSTALLATION INSTRUCTIONS

**Note:** The equipment has a connector for interconnect it with other equipment. This connector is intended to keep several devices with the same electrical potential. Not necessarily the grounding of a local connection. This connector on the back of the device is identified by the symbol on the right:

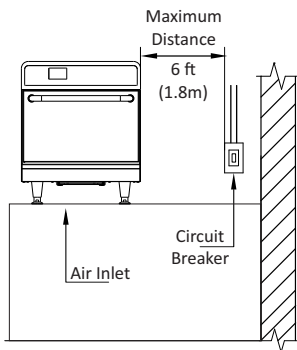

- Use of pressure cables to prevent movement of the power cable.
- In case the oven voltage is 380 volts, a neutral cable (independent of the ground) must be available.
- Ensure that the electrical characteristics of the power grid are in accordance with the technical specifications located on the identification tag label located on front bottom cover of the unit. The power grid is a customer's responsibility.
- This unit must be properly grounded to avoid electrical shock.
- The circuit breaker should be located no more than 70,8in / 6ft / 1.8m away from the unit.

## GENERAL INSTRUCTIONS

- The oven must be installed on a surface or counter that supports its weight of approximately 194lb (88 Kg).
- Do not obstruct the air inlets and outlets at the oven bottom.
- The oven must not be positioned near stoves, deep fryers, hot plates and other equipment that releases fat, fumes and heat. The ventilation, electrical panel and motor vents must be far from these heat sources to prevent damage to the electrical system of the equipment.
- The oven must be installed in a leveled and well-ventilated area.
- The installation of the equipment in a non-suitable place can result in the warranty loss.

# INSTALLATION INSTRUCTIONS

## DIMENSIONS

### RAPIDO

FRONT VIEW

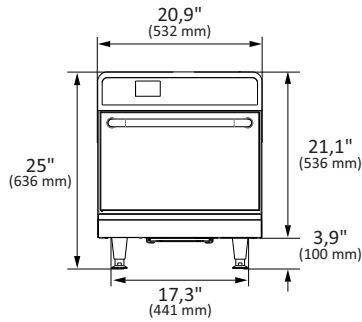

SIDE VIEW

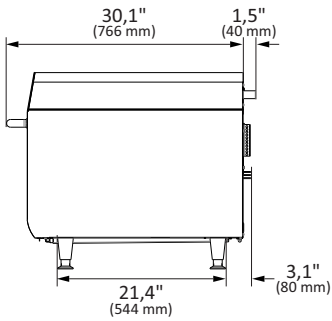

SIDE VIEW  
WITH DOOR OPEN

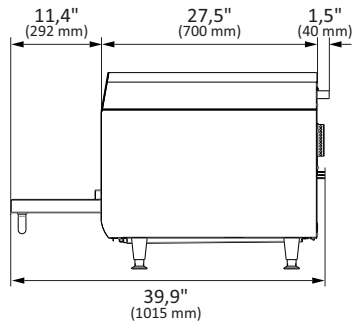

Chamber Dimension	
Capacity	21L - 0.74 cu.ft
Height	5,7" - 146 mm
Width	15,5" - 394 mm
Depth	14,2" - 362 mm

## GENERAL RECOMMENDATIONS



- Do not use this product near water, kitchen sink, wet places, or near a swimming pool.



- If a residue accumulation inside the chamber catches fire, keep the oven door closed, turn the equipment off and unplug it from the power outlet.



- Do not use the oven to dry or to store clothes.



- If the oven door is damaged, it must not be operated until it gets repaired by a qualified technician.

- In case of voltage loss or error during a recipe, the progress will be lost. Recipes will keep intact if the issue regarding power grid.
- Do not cover or block any air inlet and outlet of the unit.
- Do not use the oven outdoors.
- Do not store food inside the oven when it is not in operation.
- When enabling the oven circuit breaker, wait ten (10) seconds before turning it on.

## RAPIDO TECHNOLOGY

The **Rapido** oven uses a combination of high-speed impinged air, convection from an infra-red element, and microwave energy to heat food more quickly than a conventional oven.

The figure below illustrates the steps involving the technology:

**1** - Internal heating elements transfer thermal energy to the circulating air.

**2** - The blower motor circulates air at high speed directly into the food item.

**3** - The circulating air goes through the catalytic filter where the grease-laden vapors are broken down, and transformed in the air and water molecules.

**4** - The bottom heater irradiates heat within the oven chamber.

**5** - At the same time, magnetrons generate microwave energy that evenly heats the water molecules within the food.

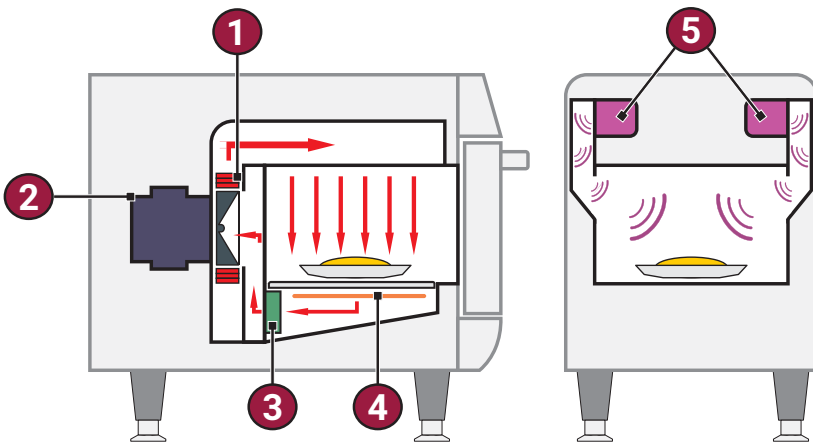



## PRINCIPLES OF OPERATION

Microwaves are a type of radiation energy. Just like radio waves, visible light and infrared, the microwaves are part of the electromagnetic spectrum, i.e., it is a form of electromagnetic radiation. They are classified as non-ionizing radiation, because, unlike x-rays, Alpha, Beta and Gamma rays, its effects are strictly thermal and therefore do not alter the molecular structure of the item that is being irradiated.

The basic principle of microwaves is to cook by molecular vibration. They penetrate the food surface in a depth that ranges from two to seven centimeters, heating the molecules of water and fat by making them vibrate. The heat is transmitted to the interior of the food by thermal conduction, demystifying the idea that the microwaves cook food from the inside out.

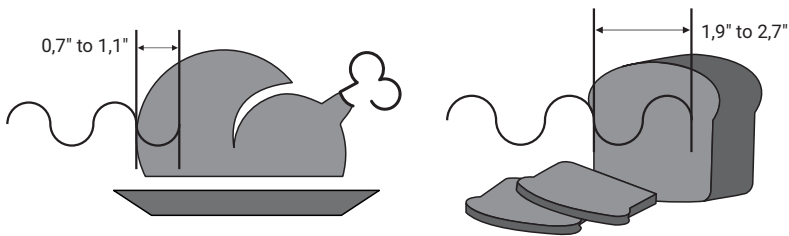

The **Rapido** works through the association between microwaves and hot air directed towards the food. The variables in the operation consists of:

- a) *Operation time.*
- b) *Chamber temperature.*
- c) *Microwaves power.*
- d) *Air speed.*

Each recipe operation can be programmed with up to eight steps and each of them can have the variables mentioned above.

**Temperatures:** The preparation times are short and so are the steps. The temperature variation between steps will not be observed by the unit. Normally, the temperature used is the same temperature as the preheating set point.

**Microwaves:** The microwave is adjustable between 0% and 100% for each 30 second fraction. For example, the microwaves in a one-minute recipe with microwave programmed at 50% will run for 15 and stop for 15 seconds. Then it will be energized for another 15 seconds and stop for the remaining 15 seconds. In 1 minute, it will act for a total of 30 seconds.

Microwaves are reflected by metals but will penetrate glass, plastics, and ceramics. The microwaves penetrates the food and generates water molecules friction, heating the food.

## FEATURES

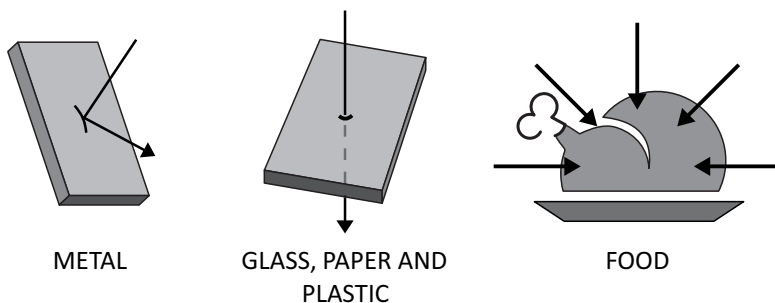

The use of plastic or paper material must respect its specifications since it must support up to 280°C/ 536°F and being microwavable.

**Operation Time:** The food heated by microwaves occur from the outside in and the penetration level will vary depending on the type of food. Therefore, the preparing time has to be related to the meal composition, the quantity of food processed, as well as its density and thickness. The larger the food amount (quantity or density), the greater the time or percentage will be needed for the microwave to take effect.

**Hot Air Speed:** The hot air speed can be adjusted between 10% and 100% of speed. The hot air is controlled by a blower motor which will envelope the food.

a) *The higher the air speed, the more likely it will be to burn the product on its surface.*

b) *The higher the air speed, the more it will affect the texture and crispness of the product.*

## RECIPES CREATION

When creating a recipe, all the variables mentioned earlier should be considered. The microwaves and the air speed are both critical factors for a successful preparation.

To get faster results in the recipe creation, we suggest beginning programming at 1/10 of the total time of preparation used in a conventional process.

The microwave effect is more efficient at the beginning of processes. For frozen products, work with two or three steps, so that at the beginning of the process the product is thawed with lower microwave levels and at the end of the process the colour and crispness are obtained.

Later, combine the air speed variations to reach the desired crispness and color. Remember, the air also transmits heat to the food so keep that in mind when setting blower percentage. The food's weight, size, and shape are critical when setting the total cook time.

### **The following information is critical when creating a new recipe:**

- a) The initial temperature of the product will change the desired results if the following conditions are not considered: preheating and meal condition (refrigerated, frozen or in room temperature)*
- b) The size and/or weight variation of the meal has to be considered when programming a standard recipe.*
- c) Only use containers approved for a microwave oven to prevent any damage and that the product gets properly cooked.*

## OPERATION

### PREHEATING

a) When you turn the oven on - the following message will appear:





b) When 525°F is reached, a message will appear in the display showing that there will be 5 minutes to the end of preheating process.

### PLAY RECIPES

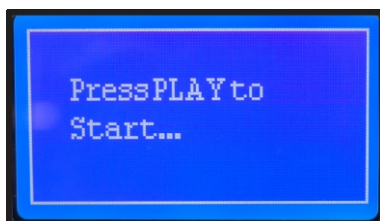
a) Switch on the oven and wait until the following message appears.



b) Press  to display the group's screen;

c) To select a group, use the keys  /  or type the number of the group.





d) To start a recipe, use the arrows ▲ / ▼ or type the recipe's number using the alphanumeric keyboard.



e) During the process, the display will show the cooking time, group and the recipe's name.

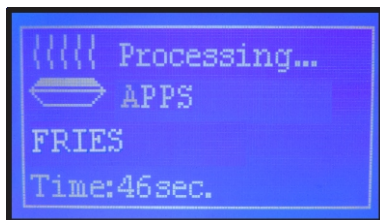

d) At the end of the cooking, the alarm will sound and the message **“Ready”** will appear.

e) The **“Cook More”** function will be enable to use after the end of preparation, with the door opened. Close the door and press:

**1** More 10 seconds

**2** More 20 seconds



**3** More 30 seconds

This option will be available for 10 seconds after the door is closed.

## CREATING AND EDITING GROUPS

a) While in the group's menu, press  to allow the edition function, as shown:





b) With arrows  /  or alphanumeric panel, select which group edit.



c) Enter the password (123 - standard) using the alphanumeric keyboard and press  to enter the edition mode.



d) Press  to edit group's name or create a new group.

 to erase or backspace.

 to 0(zero) or '\_' and '\*' symbols.

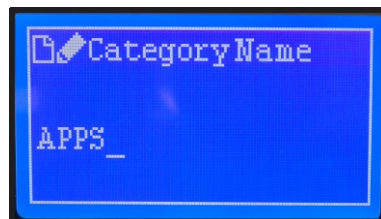
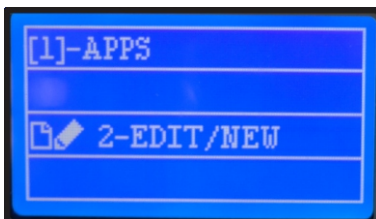

 up to  to numbers and letters.

To save changes, press  to save.



## CREATING, EDITING AND DELETING RECIPES



a) While in the recipe's menu, press  to allow the edition function.

b) With arrows  /  or alphanumeric panel, select which recipe edit.



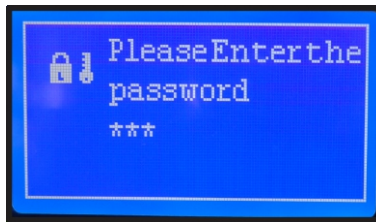

c) Enter the password (123 - standard) using the alphanumeric keyboard and press  to enter the edition mode.





d) Press  to edit recipe's name or create a new recipe or press  to delete the recipe.

 to erase or backspace.

 to 0(zero) or '\_' and '\*' symbols.

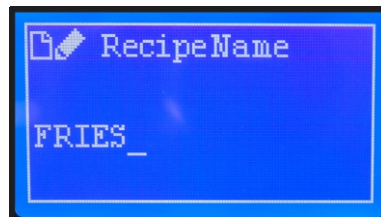
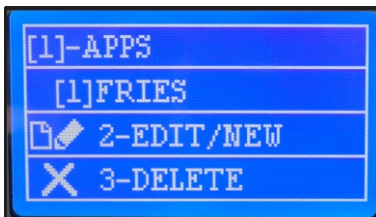
 up to  to numbers and letters.





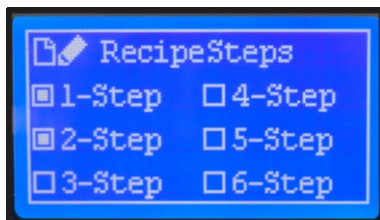

e) To save changes, press  to save and edit steps. Each recipe supports up to 6 steps. Use the alphanumeric keypad to select the step to be added or edited.



f) The following parameter settings will appear: time, chamber temperature, microwave percentage and hot air speed.





g) Use the arrows  /  to navigate through and choose the parameter. Press  to edit.

h) Set the parameter value with the alphanumeric keypad and press  to confirm and save.



i) To **DELETE** a step, set the time value to zero.

j) Press  to save, and  to go back.





## MANUAL MODE

a) While in the recipe's menu, press  to enter the manual mode.



b) The following will appear: time, chamber temperature, microwaves power and hot air speed.



c) Use the arrows  /  to navigate through and choose the parameter, press  to select and edit.

d) Set the parameter value with the alphanumeric keypad.



e) Press  to confirm and  to start.

f) During the process, the display will show only the cooking time.

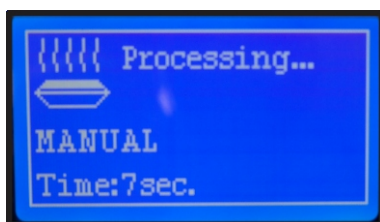

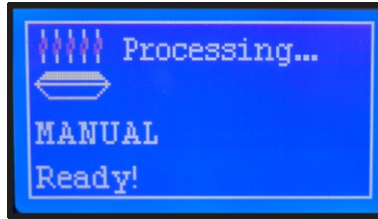

g) At the end of the cooking, the alarm will sound and the message **"Ready"** will appear.

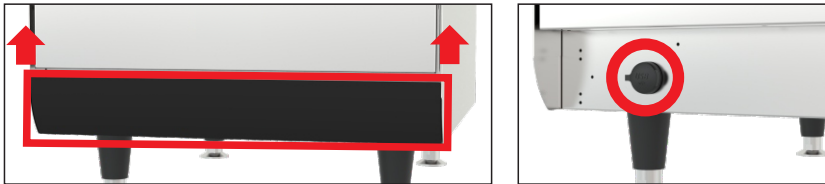

## IMPORTING AND EXPORTING FUNCTION

a) To access the USB connector, lift the bottom cover and pull to remove it. Do the opposite process to replace.



b) Press . Using the alphanumeric keyboard, press 2 or 3 Export or Import recipes:

 *Export Recipes - The recipes are copied from the oven to the Flash Drive.*

 *Import Recipes - The recipes are copied from the Flash Drive to the oven.*

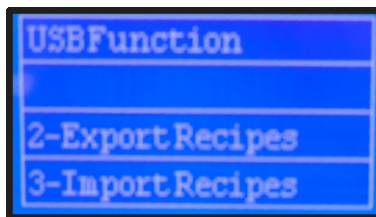

c) Using the alphanumeric keyboard, press  to export/import all recipes from the oven to Flash Drive.



d) Wait until the message: **"Operation Completed"**.

### **IMPORTANT**

- When the **IMPORT** command is executed, all the oven's recipes are replaced.
- When the **EXPORT** command is executed, all the Flash Drive's recipes are replaced.

### **COOLING THE OVEN**

a) Press  and open the oven's door. The display will indicate that cooling is in progress. Wait until the desired temperature is reached. The cooling function can be turned on at any time.



b) The oven automatically shuts off after reaching the temperature of 149°F, without the need for operator monitoring.

### **ATTENTION**

***During the cooling process, that fan remains on even with the door open.***

## TEMPERATURA INSPECTION



- a) While in the recipe's menu, press  to inspect the temperature mode.
- b) The following settings will appear: Chamber temperature and bottom radiant heater temperature.

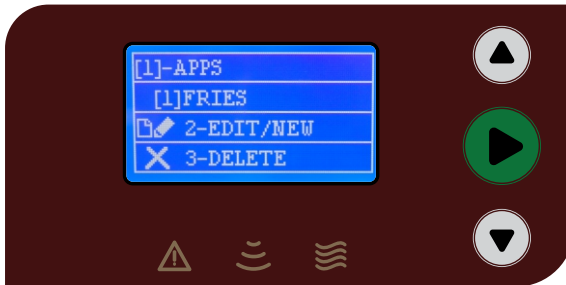

- c) Press  to go back to the recipe's screen.

## INFORMATION LEDS



- a) There are three LEDs under the oven's screen to inform the status:
-  : There is a system failure, please contact an authorized technician.
  -  : The Microwave is on.
  -  : Heating is on.

## CLEANING INSTRUCTIONS

a) Only use a professional product specific for speed ovens to clean the oven.



***Cloth***



***Anti-abrasive sponge***

## PROCEDURE



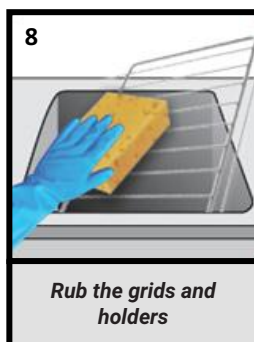

## CLEANING THE CATALYTIC CONVERTER

a) To access the catalytic converter, remove the baking stone, the rack, and the bottom jet-plate from the oven. Then remove the catalytic through a vertical movement upwards, as shown in the following image.

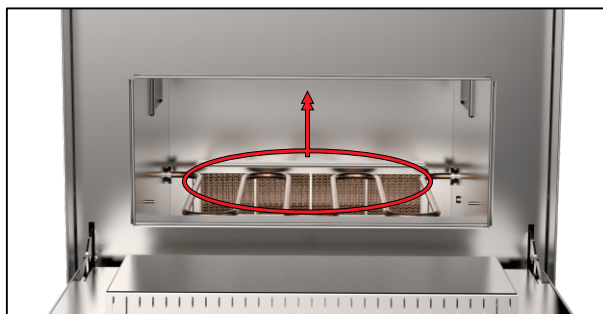

b) Spray approved cleaner on the catalytic converter. Leave it in for 15 minutes, rinse thoroughly with clean water. Shake excess water from the filter and pat dry with paper towels before re-installing.

## **CLEANING THE AIR FILTER**

*a) To have access to the air filter, pull it under the oven.*

*b) Then, remove the filter with a forward movement, as in the image:*



*c) To sanitize correctly, place the filter to soak in warm water with neutral detergent.*

*e) Leave it for 15 minutes, rinse it well and install the air filter again.*

### **TECH SUPPORT:**

**MON - FRI 8:30 AM - 5:00 PM EST**

**(888) 275-4538 EXT 611**

**[SERVICE@MVPGROUPCORP.COM](mailto:SERVICE@MVPGROUPCORP.COM)**

**(888) 275-4538 EXT 612**

**AXIS - RAPIDO**  
**CODE: 742776**  
INSTALLATION AND OPERATIONAL MANUAL  
OCTOBER 2022 - VERSION 02











[www.mvpgroupcorp.com](http://www.mvpgroupcorp.com)

**3560 NW 56th Street  
Fort Lauderdale, FL 33309**

**Tel.: 786.600.4687  
Toll Free: 844.218.8477  
Fax.: 786.661.4100**