

In order to provide the best service, ATOSA requests that please register your warranty online at www.atosausa.com

For any service issues, please kindly contact us at Email: warranty@atosausa.com

or

Toll Free: +1-800-683-8660

**Please clean the filter frequently!
Please do not overload the unit!**

INSTRUCTION MANUAL

SALAD PREP TABLE

PIZZA PREP TABLE

UNDERCOUNTER

WORK TOP

CHEF BASE



*Please read the user's manual before you use this product.
If you request unnecessary services, you may waste money.
Thus, fix simple troubles by yourself which you have found.*



Installation, use and maintenance instructions

INDEX

1	Terms and conditions.....	2
2	Preface.....	6
3	Introduction.....	9
4	Manufacturer's retained rights and responsibility.....	9
5	Transportation and storage.....	10
6	Commissioning.....	10
	6.1 Positioning.....	10
	6.2 Initial cleaning.....	11
	6.3 Connection to electrical supply.....	11
	6.4 Connection to drains.....	12
7	Technical characteristics.....	13
	7.1 Noise and vibration.....	13
	7.2 Possible applications.....	13
8	Usage.....	13
	8.1 Activation.....	13
	8.2 Storage of food-stuffs.....	13
	8.3 Defrosting.....	14
	8.3.1 Defrost timer.....	14
9	Maintenance.....	14
	9.1 Periodic cleaning.....	14
	9.2 Cleaning of condenser.....	14
	9.3 Period of inactivity of cabinet.....	15
10	Trouble shooting and remedies.....	15
	10.1 If the cabinet does not operate.....	15
	10.2 If the required temperature is not achieved.....	15
	10.3 If the cabinet leaks water.....	16
	10.4 If the cabinet is unacceptably noisy.....	16
	10.5 Improbable risks.....	16
11	Substitution of spares.....	17
12	Dismantling.....	17
	Operating Instruction.....	17
	Official approval and Rules.....	22
	Technical Parameters.....	23



1 TERMS AND CONDITIONS:

Refrigeration

2 YEAR WARRANTY

All claims for parts or labor must be made directly through Atosa. All claims must include: model number of the unit, the serial number, proof of purchase, date of installation, and all pertinent information supporting the alleged defect. In case of compressor replacement under warranty, either compressor or compressor tag must be returned to Atosa along with above listed information. Failure to comply with warranty policies will result in voiding claims.

Two Year Parts & Labor Warranty

Atosa warrants all new refrigerated components, such as the cabinet and all parts, to be free from defects in materials or workmanship. Atosa's obligation under this warranty is limited to a period of two (2) years from the date of original installation or 27 months after shipment date from Atosa, whichever occurs first. All parts covered under this warranty that are defective within two (2) years of original installation or twenty seven (27) months after shipment date from manufacturer, whichever occurs first, are limited to repair or replacement (including labor charges, of defective parts or assemblies). The labor warranty shall include standard straight time labor charges only and reasonable travel time, as determined by Atosa.



Additional Three Year Compressor Warranty

In addition to the two (2) year warranty stated above, Atosa warrants its sealed compressor to be free from defects in both material and workmanship under normal and proper use and maintenance service for a period of three (3) additional years from the date of original installation, but not to exceed five (5) years. Compressors that have been determined to be defective from Atosa within this extended period will be either repaired or replaced with a compressor or compressor parts of similar design and capacity according to Atosa 's discretion. The three (3) year extended compressor warranty applies only to sealed parts of the compressor and does not apply to any other parts or components. This includes, the cabinet, paint finish, temperature control, refrigerant, metering device, motor starting equipment, fan assembly, and other electrical components, etc.

R290 Compressor Warranty

The five-year compressor warranty detailed above will be void if the following procedure is not carefully adhered to:

1. This system contains R290 refrigerant and lubricant. The lubricant has rapid moisture absorbing qualities.
2. Drier replacement is very important and must be changed when a system is opened for servicing.
3. Micron level vacuums must be achieved to insure low moisture levels in the system.
4. Compressor must be obtained through Atosa, unless otherwise specified in writing, through Atosa' s warranty department.



What is Not Covered by This Warranty

Atosa 's sole obligation under this warranty is limited to either repair or replacement of parts, subject to the additional limitations below. This warranty neither assumes nor authorizes any person to assume obligations other than those expressly covered by this warranty.

NO CONSEQUENTIAL DAMAGES: ATOSA IS NOT RESPONSIBLE FOR ECONOMIC LOSS; PROFIT LOSS; OR SPECIAL, INDIRECT, OR CONSEQUENTIAL DAMAGES, INCLUDING WITHOUT LIMITATION, LOSSES, OR DAMAGES ARISING FROM FOOD OR PRODUCT SPOILAGE, REGARDLESS OF WHETHER OR NOT THEY RESULT FROM REFRIGERATION FAILURE.

WARRANTY IS NOT TRANSFERABLE: This warranty is not assignable and applies only in favor of the original purchaser/user to whom delivered. ANY SUCH ASSIGNMENT OR TRANSFER SHALL VOID THE WARRANTIES HEREIN AND SHALL VOID ALL WARRANTIES, EXPRESS OR IMPLIED, INCLUDING ANY WARRANTY OF MERCHANTABILITY OR LABOR COVERAGE FOR COMPONENT FAILURE OR OTHER THE WARRANTY PACKET PROVIDED WITH THE UNIT.

ALTERATION, NEGLIGENCE, ABUSE, MISUSE, ACCIDENT, DAMAGE DURING TRANSIT OR INSTALLATION, FIRE, FOOD, OR ACTS OF

GOD: Atosa is not responsible for the repair or replacement of any parts that are determined to have been subjected after the date of manufacture to alteration, neglect, abuse, misuse, accident, damage during transit or installation, fire, flood, or act of God.



IMPROPER ELECTRICAL CONNECTIONS: Atosa IS NOT RESPONSIBLE FOR THE REPAIR OR REPLACEMENT OF FAILED OR DAMAGED COMPONENTS RESULTING FROM ELECTRICAL POWER FAILURE, THE USE OF EXTENSION CORDS, LOW VOLTAGE, OR VOLTAGE DROPS TO THE UNIT. THE TWO (2) YEAR PARTS & LABOR WARRANTY AND THE ADDITIONAL THREE (3) YEAR COM-PRESSOR WARRANTY ARE AS DESCRIBED ABOVE. THESE WARRANTIES ARE EXCLUSIVE AND IN LIEU OF ALL OTHER WARRANTIES, INCLUDING IMPLIED WARRANTY AND MERCHANTABILITY OR FITNESS FOR A PARTICULAR PURPOSE. THERE ARE NO WARRANTIES WHICH EXTEND BEYOND THE DESCRIPTION ON THE FACE HEREOF.

Outside U.S. and Canada: This warranty does not apply to areas outside the continent of the United States. Atosa is not responsible for any warranty claims made on products sold or used in such areas.*In some cases, a 25% restocking fee may be charged to a buyer for returned items.*Atosa may at any time modify our equipment in order to provide and insure a superior product. Change is sometimes necessary to keep up with today's high standards in our industry. Atosa reserves the final interpretation of all public materials.



2. Preface

Please read instructions before using this appliance.

IMPORTANT SAFETY INSTRUCTION

- ▲ To reduce the risk of fire, electric shock, or injury to persons when using your product, basic safety precautions should be followed, including the following.
- ▲ This appliance must be properly installed and located in accordance with the Installation Instruction before it is used.
- ▲ Before the appliance is plugged in, ensure that the rated voltage corresponds to the voltage of the electrical system in your home. The power plug should have its own independent socket. Using adapters may cause overheating or burning.
- ▲ This appliance can be used by children aged from 8 years and above and persons with reduced physical, sensory or mental capabilities or lack of experience and knowledge if they have been given supervision or instruction concerning use of the appliance in a safe way and understand the hazards involved.
- ▲ Children shall not play with the appliance.
- ▲ Cleaning and user maintenance shall not be made by children without supervision.
- ▲ If the supply cord is damaged, it must be replaced by the manufacturer or its service agent or a similarly qualified person in order to avoid a hazard.
- ▲ Connect to properly grounded outlets only. Avoid the use of extension cords. Do not run cord under carpeting, runners or the like. Arrange cord away from traffic area and where it will not create a tripping hazard.
- ▲ Always unplug appliance when not in use and before cleaning, adjusting or maintaining this machine. To disconnect appliance, turn switch off and remove plug from power source.



- ▲ Do not disconnect by pulling on the cord. Always disconnect by grasping and pulling on the plug top.
- ▲ Do not pull out the cord or touch the power plug with wet hands. Clean water or dust from the power plug and insert it with the ends of the pins securely connected.
- ▲ Do not use outdoors.
- ▲ Do not splash water on the appliance. It may cause a malfunction or electric shock.
- ▲ Do not disassemble, repair or alter the appliance. It may cause fire or abnormal operations, which may lead to injury.
- ▲ After your fridge-freezer is in operation, do not touch the cold surfaces in the freezer compartment, particularly when hands are damp or wet. Skin may adhere to these extremely cold surfaces.
- ▲ Never place glass products in the freezer because they may be broken when their inner contents are frozen.
- ▲ The refrigerant and insulation blowing gas used in the appliance require special disposal procedures. When disposal, please consult with service agent or a similarly qualified person.
- ▲ Do not store explosive substances such as aerosol cans with a flammable propellant in this appliance.
- ▲ WARNING: Keep clear of obstruction all ventilation openings in the appliance enclosure or in the structure for building-in.
- ▲ WARNING: Do not use mechanical devices or other means to accelerate the defrosting process, other than those recommended by the manufacturer.
- ▲ WARNING: Do not damage the refrigerant circuit.
- ▲ WARNING: Do not use electrical appliances inside the food storage compartments of the appliance, unless they are of the type recommended by the manufacturer.



Warning: Risk of fire / flammable materials

CAUTION: RISK OF FIRE AND EXPLOSION WITH FLAMMABLE REFRIGERANT R290.

▲ If you need the electronic version instruction manual, please ask the manufacturer or its service agent .

▲ Max. Load of shelf is 40 kg.

This instruction manual provides all the necessary information regarding:

- ▲ use of the refrigerator
- ▲ technical specifications
- ▲ installation and handling
- ▲ operator procedures and instructions
- ▲ maintenance operation

The manual is to be considered an integral part of the refrigerator and should be stored in a safe place for future consult to permit a good working life of the refrigerator.

The appliance is intended for commercial use only.

■ Component parts shall be replaced with like components and that servicing shall be done by factory authorized service personnel.



3 INTRODUCTION

This equipment has been produced be internally or externally in its aesthetics and componability. In response to the specific exigencies of our clientele; furthermore it has been mechanically and aesthetically checked in every aspect before despatch. For the correct utilisation of the equipment; carefully read the instructions, observe all the recommendations contained therein, consign this manual which constitutes an integral part of the essence of the equipment to the end user who is requested to retain it for future consultation. By observing these recommendations, you will guarantee the extended trouble-free operation of the equipment.

4 MANUFACTURER'S RETAINED RIGHTS AND RESPONSIBILITY

It is forbidden to reproduce, partially or totally, these instructions without the express authorisation of the manufacturers.

The manufacturers deny all responsibility to third parties in consequence of:

- Non observance of the warnings and instruction contained in the test;
- Non observance of the parameters of utilisation of the equipment;
- Unreasonable or wrongful utilisation by un-trained personnel;
- use non conforming to local statutes;
- Unauthorized modifications and/or repairs undertaken by non trained or authorized personnel.
- Utilisation of non original spares or accessories;
- Exceptional occurrences;
- Imprecise instructions contained for whatever reason in the current manual;



The manufacturers reserve the right to introduce any modification deemed necessary without warning.

5 TRANSPORTATION AND STORAGE

The equipment is wrapped in absorbent material and contained and fixed within a wooden platform and paper box.

Whilst awaiting by definitive collection, these should be stored within a protected and covered environment at a temperature between -25°C / $+55^{\circ}\text{C}$, with ambient humidity between 30 / 95%. Do not stack more than four items.

6 COMMISSIONING

Carefully read the label on the equipment, do not cover for any reason whatsoever. and replace them immediately if damaged. Do not remove protection or panelling that require the usage of tools.

6.1 POSITIONING

Ensure that in respect of the dimensions, the space reserved for the equipment permits its correct utilisation and ease of maintenance. After carefully unpacking the display case, remove the white PVC protective film and all of the manufacturer's material which safeguards the item in transit. Place the cabinet on a flat surface and level it by screwing and adjusting the leveling legs to ensure its efficient operation. The cabinet must be lifted only from the exterior of the base to avoid the possibility of damage. Do not move the cabinet by application of pressure to the surface.



if the device has been positioned horizontally (integral condensing unit).wait two hours before activating it. Packing and protective film should be disposed off as indicated by the local authorities. The equipment must not be installed within explosive ambience, In the open air or exposed to rain the correct siting is; distant from direct sources (radiators, direct lighting, etc...) and protected from direct sunlight and draughts. Air circulation must be freely maintained around the condensing unit, be it integral or remote. In observance of these specific conditions will detrimentally affect the cabinet.

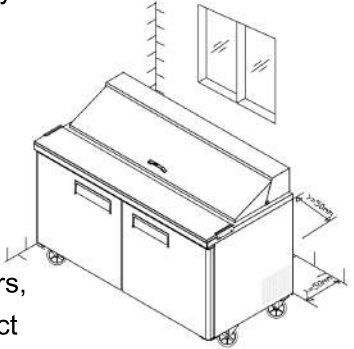

6.2 INITIAL CLEANING

Before use all parts of the cabinet should be cleaned, For the walls and all the internal parts use an antibacterial detergent. For the plastic parts use a moistened cloth. Dry with a soft clean cloth. use little or no water.

Do not use harsh or abrasive solvents or detergents

During cleaning do not approach bare-handed those parts which could cut (evaporator, condenser, etc.)and always use protective gloves.



6.3 Electrical connection

Check that the supply conforms to the requirements listed on the factory label and that it is provided with a fall-safe protection or automatic circuit

breaker with an efficient earth connection. Should there not be an electrical safety feature have this introduced by a qualified person. by means of a omnipolar switch as indicated in the safety regulations with a means of a omnipolar switch as indicated in the safety regulations with a minimum clearance of the contacts of 3 mm. where the cabinet has to be installed at some distance from the electrical source. ensure that the conforms to the local regulations. Cabinet supplied with integral condensing units are provided with an appropriate plug fitted with a neutral and earth; the supply cable must be well stretched (avoid coiling and superimposition). it must not be exposed to the possibility of damage by third parties. it should not be in contact with liquids, water or heat sources. in the event of damage it must be replaced by qualified personnel. Always avoid the use of reducers or adapters.

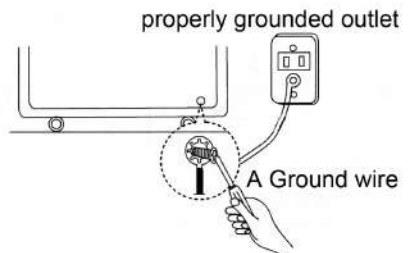
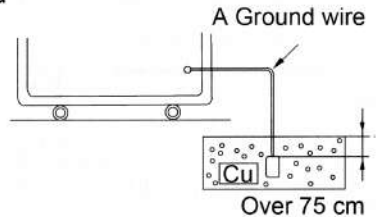
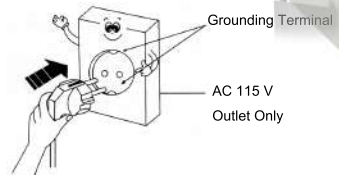

6.4 CONNECTION TO DRAINS

The dispersal of defrost water is automatic in all models with integral condensing unit.



7 TECHNICAL CHARACTERISTICS

7.1 NOISE AND VIBRATION

The sound level of the equipment fitted with integral hermetic condensing unit does not exceed 70 dB ,it is therefore not necessary to provide sound insulation. Under normal conditions the equipment does not generate vibrations which affect surroundings.

7.2 POSSIBLE USAGES

Do not utilise the equipment to store medical supplies.
the optimum operational ambient temperatures are between
 $+10^{\circ}\text{C}$ / $+40^{\circ}\text{C}$.

The possible application are: display salads ,keep cooling;
preparation, and sale of salads, fruits, Vegetables and cold dishes

8 USAGE

8.1 ACTION

Power connection and adjust the thermostat.

8.2 STORAGE OF FOOD-STUFFS

In order to obtain the best functioning of the case it is necessary to observe the following instruction:



- Place the merchandise into the unit only after it has reached the desired operating temperature given on the digital display.
- Do not place uncovered hot foods or liquids inside the unit
- Package or protect foods when possible
- Do not limit the circulation of air inside the call with superfluous obstacles.
- Avoid frequent or prolonged openings of the door/drawers
- Wait a few moments before reopening the door/drawer just after it has been closed.

Whilst stocking only open and fill a drawer at a time to eliminate the risk of over-balancing or ask to the supplier the fixable feets.

8.3 DEFROSTING

8.3.1 DEFROST TIMER

The defrost timer automatically 4 times in 24 hours, its timer will reset to the time of the initial first start-up.

9 MAINTENANCE

9.1 PERIODIC CLEANING

For hygienic reasons and improved performance clean at least once a week the internal basin. Make sure switch off the power supply before cleaning..

9.2 CLEANING OF CONDENSER

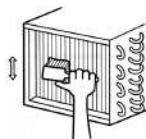

For improved performance clean the condenser at least once a month.



Before beginning turn off the equipment, and disconnect the plug.
Close and protect the unit.

- Unscrew, rotate and remove protective grill
- Remove the dust deposited on the front surface of the condenser using a brush and a vacuum cleaner and restore previous conditions.

9.3 PERIOD OF INACTIVITY OF CABINET

During periods of inactivity, remove the products from the cabinet and then follow these directions:

- Remove the plug out from the outlet and carefully clean the unit as per periodic cleaning
- Cover the cabinet with a cloth that allows air circulation in the interior.

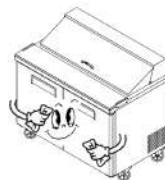

10 TROUBLE SHOOTING AND REMEDIES

Often, the malfunction of a unit is due to simple causes which can easily be eliminated without contacting a technician.

Therefore execute the following controls



10.1 If the cabinet does not operate, make sure that:

- The plug has been correctly inserted into the socket.
- The supply cord is not damaged.

10.2 If the required temperature is not achieved, make sure that;

- The command switch is turned on.
- The thermostat range is correctly regulated .



- The cabinet is neither in the defrosting phase nor in the post-defrosting phase.
- The evaporator is not covered with frost .
- The condenser is not blocked with dust.
- The cabinet is not located near heat sources or its condensing unit has uninterrupted air flow.
- The stored foods or other objects do not inhibit proper closing of the unit.
- The cabinet is not working in anomalous conditions (overloaded, loaded with hot food, or loaded in a way that prevents proper air circulation).

10.3 If the cabinet leaks water, make that:

- The collecting container or the device for condensing water elimination are not damaged.
- The discharge outlets are not blocked or obstructed.
- The cabinet has been properly leveled.

10.4 If the cabinet is unacceptably noisy, make sure that:

- The frame does not have loose screws or bolts.
- The cabinet has been laid in a stable position and correctly leveled.

If, after all these controls, the malfunctioning continues, it is advisable to contact technical assistance. Be prepared to supply the following information:

- The model trade name and the serial number (both can be found on the technical data plate).

10.5 IMPROBABLE RISKS

In case of fire unplug the cabinet, if possible, and use a powder fire extinguisher.



11 SUBSTITUTION OF SPARES

Before commencing any service or maintenance work, isolate the cabinet from the electrical supply.

Always fit original spares which may be obtained from an authorized concessionaire or stockist.

12 DISMANTLING

The scrapping of the cabinet requires to be undertaken by specialized company, licensed by the local authorities, and observing local statutes.

Polyurethane foaming material, not fire-resistant, when deal with the material, should be according with local law and statute.

- The cabinet consists of:
- Structure in steel plate,
- Electrical components and cables,
- Electrical compressor.
- Plastic materials,
- Refrigerant fluid which must not be discharged into the atmosphere.

Operating Instruction



1. New upright air-cooling refrigerator should be opened and ventilate it before it is in use.
2. After connecting the power supply, press the "POWER" switch on the controller keyboard (Green Indicator Light ON), the fridge will come to work. The microcomputer controller, installed in the controller keyboard, could automatically adjust the temperature ranges. This intelligent digital controller works as: if the temperature increases and reaches set point plus differential the compressor is started and then turned off when the temperature reaches the set point value again.



3. Microcomputer Controller Operation Instruction:

Display and functions:

During normal operation, the controller displays the value of the probe set using parameter/4(=1 ambient probe, default, =2 second probe, =3 third probe). In addition, the display has LEDs that indicate the activation of the control functions (see Table 1), while the 3 buttons can be used to activate/deactivate some of the functions (see table 2).

LEDs and associated functions Tab.1

icon	function	normal operation			start up
		ON	OFF	blink	
	Compressor	on	off	request	ON
	fan	on	off	request	ON
	defrost	on	off	request	ON
AUX	aux	output on	output off	-	ON
	alarm	all	no alarm	-	ON
	clock	RTC fitted and enabled, at least 1 time band set	RTC not fitted or disabled, not even 1 time band set	-	ON if RTC fitted

Table of functions activated by the buttons Tab.2

button	normal operation		start up	
	pressing the button alone	pressed together		
up ON/OFF	more than 3s toggle ON/OFF	pressed together start/stop continuous cycle	-	
down defrost	more than 3s: start/stop defrost			
set mute	-1s: display/set the set point -more than 3s: access parameter setting menu (enter password 22) -mute audible alarm (buzzer)	-	Pressed together start parameter reset procedure	for 1s display firmware vers. code for 1s RESET current EZY set



Setting the set point(desired temperature)

- press SET for 1s the set value will start flashing after a few moments;
- increase or decrease the value using UP or DOWN;
- press SET to confirm the new value.

Switching the device ON/OFF

Press UP for more than 3s. the control and defrost algorithms are now disabled and the instrument displays the message "OFF" alternating with the temperature read by the set probe.

Manual defrost

Press for DOWN more than 3s (the defrost starts only the temperature conditions are valid).

Continuous cycle

Press UP and DOWN together for more than 3s.

Table of alarms

Alam code	buzzer and alarm relay	LED	Description	Parametri coinvolti
E0	active	ON	probe 1 error=control	-
E1	inactive	ON	probe 2 error=defrost	[d0=0/1]
E2	inactive	ON	probe 3 error=condenser	[A4=10]
IA	active	ON	external alarm	[A4=10][+A7]
dOr	active	ON	open door alarm	[A4=7/8][+A7]
LO	active	ON	low temperature alarm	[AL][Ad]
HI	active	ON	high temperature alarm	[Ah][Ad]
EE	inactive	ON	unit parameter error	-
EF	inactive	ON	operating parameter error	-
Ed	inactive	ON	defrost ended by timeout	[dP][dt][d4][A8]
dF	inactive	ON	defrost running	[d6=0]
cht	inactive	ON	condenser dirty pre-alarm	[A4=10]
CHT	active	ON	condenser dirty alarm	[A4=10]
EtC	inactive	ON	dock alarm	



Dixell XR02CX XR03CX XR06CX

1. Microcomputer panel sketch map, meanings of running indicator light and LED showing.
2. **SET** To display target set point, in programming mode it selects a parameter or confirm an operation.





(Mod. XR06CX)

 To start a manual defrost.

 In programming mode it browses the parameter codes or increases the displayed value .

 _{AUX} In programming mode it browses the parameter codes or decreases the displayed value .

 +  To lock or unlock the keyboard

SET +  To enter in programming mode



SET +  To return to room temperature display .

3. How to see the point .

Push and immediately release the SET key, the set point will be showed;
Push and immediately release the SET key or wait about 5s to return to normal visualisation.

4. How to change the setpoint .





Push the SET key for more than 2 seconds to change the Set point value;
The value of the set point will be displayed and the “°C” or “°F” LED starts blinking;

To change the Set value push the  or  _{AUX} arrows.

To memorise the new set point value push the SET key again or wait 10s.

5. How to start a manual defrost .

Push the DEF  key for more than 2 seconds and a manual defrost will start .

LED	MODE	SIGNIFICATO
	On	Compressor enabled
	Flashing	Anti short cycle delay enabled (AC parameter)
	On	Defrost in progress
	Flashing	Dripping in progress
	On	Fans output enabled
	Flashing	Fans delay after defrost
	On	Measurement unit
	Flashing	Programming mode
	On	Measurement unit
	Flashing	Programming mode



6. How to change a parameter value

To change the parameter's value operate as follows:

Enter the Programming mode by pressing the **SET+▼** keys for 3s
("°C" or "°F" LED starts blinking).

Select the required parameter. Press the "SET" key to display its value
Use **▲** or **▼_{AUX}** to change its value.

Press "SET" to store the new value and move to the following parameter.

To exit: Press **SET+▲** or wait 15s without pressing a key.

NOTE: the set value is stored even when the procedure is exited by
waiting the time-out to expire.

7. To lock the keyboard .

Keep pressed for more than 3s the **▼+▲** keys.

The "OF" message will be displayed and the keyboard will be locked.

If a key is pressed more than 3s the "OF" message will be displayed.

8. To unlock the keyboard .

Keep pressed together for more than 3s the **▼+▲** keys till the "on"
message will be displayed .

9. Alarm signalling .

Mess.	Cause	Outputs
"P1"	Room probe failure	Compressor output according to "Cy" e "Cn"
"P2"	Evaporator probe failure	Defrost end is timed
"HA"	Maximum temperature alarm	Outputs unchanged
"LA"	Minimum temperature alarm	Outputs unchanged
"EA"	External alarm	Outputs unchanged
"CA"	Serious external alarm	All outputs OFF
"dA"	Door Open	Compressor and fans restarts



OFFICIAL APPROVAL AND RULES

CONFORMS TO UL STD.471

CERTIFIED TO CSA STD.C22.2 NO.120

CONFORMS TO NSF/ANSI STD. 7



Intertek
4003935
CONFORMS TO UL STD.471
CERTIFIED TO CSA STD.C22.2 NO.120



Intertek
4003935
CONFORMS TO NSF/ANSI STD.7



Technical Parameters

Product	Model code	Power source (V)	Rating frequency(Hz)	Input power (w)	Rated current(A)	Temperature range (c)	Refrigerant	Amount(oz)	Dimension (mm)	Volume (cuft)
Undercounter	MGF8401GR	115	60	260	2.3	+1~+8	R290	2.5	698x762x929	7.15
	MGF8402GR	115	60	260	2.3	+1~+8	R290	3.9	1225x762x929	13.38
	MGF8403GR	115	60	320	2.8	+1~+8	R290	4.2	1530x762x929	17.2
	MGF8404GR	115	60	320	2.8	+1~+8	R290	4.2	1846x762x929	21.13
	MGF8405GR	115	60	200	1.8	-22~-17	R290	3.5	698x762x929	7.15
	MGF8406GR	115	60	300	2.6	-22~-17	R290	4.6	1225x762x929	13.38
	MGF8407GR	115	60	300	2.6	-22~-17	R290	4.6	1530x762x929	17.2
	MGF36RGR	115	60	260	2.3	+1~+8	R290	3.5	923x762x929	8.68
	MGF36FGR	115	60	300	2.6	-22~-17	R290	3.9	923x762x929	8.68
Work Top Refrigerator	MGF8408GR	115	60	260	2.3	+1~+8	R290	2.5	698x762x1035	7.15
	MGF8409GR	115	60	260	2.3	+1~+8	R290	3.9	1225x762x1035	13.38
	MGF8410GR	115	60	320	2.8	+1~+8	R290	4.2	1530x762x1035	17.2
	MGF8411GR	115	60	320	2.8	+1~+8	R290	4.2	1846x762x1035	21.13
	MGF8412GR	115	60	200	1.8	-22~-17	R290	3.5	698x762x1035	7.15
	MGF8413GR	115	60	300	2.6	-22~-17	R290	4.6	1225x762x1035	13.38
	MGF8414GR	115	60	300	2.6	-22~-17	R290	4.6	1530x762x1035	17.2
	MGF36RWGR	115	60	260	2.3	+1~+8	R290	3.5	923x762x929	8.68
	MGF36FWGR	115	60	300	2.6	-22~-17	R290	3.9	923x762x929	8.68
Chef Base	MGF8448GR	115	60	260	2.3	+1~+8	R290	3.9	904x815x520	4.7
	MGF8449GR	115	60	260	2.3	+1~+8	R290	3.9	1056x815x520	4.7
	MGF8450GR	115	60	260	2.3	+1~+8	R290	4.6	1230x815x520	7.7
	MGF8451GR	115	60	260	2.3	+1~+8	R290	4.6	1318x815x520	8.4
	MGF8452GR	115	60	260	2.3	+1~+8	R290	4.6	1536x815x520	8.4
	MGF8453GR	115	60	260	2.3	+1~+8	R290	4.6	1840x815x520	12.1
	MGF8454GR	115	60	260	2.3	+1~+8	R290	4.6	1930x815x520	12.1



Product	Model code	Power source (V)	Rating frequency(Hz)	Input power (w)	Rated current(A)	Temperature range (°C)	Refrigerant	Amount(oz)	Dimension (mm)	Volume (cu.ft)
Salad Prep table	MSF8301GR	115	60	260	2.3	+1~+8	R290	2.8	698x762x1109	7.15
	MSF8302GR	115	60	260	2.3	+1~+8	R290	4.2	1225x762x1109	13.38
	MSF8303GR	115	60	320	2.8	+1~+8	R290	4.2	1530x762x1109	17.2
	MSF8304GR	115	60	320	2.8	+1~+8	R290	4.6	1846x762x1109	21.13
	MSF3610GR	115	60	260	2.3	+1~+8	R290	3.5	923x762x1109	8.68
Mega Top	MSF8305GR	115	60	260	2.3	+1~+8	R290	2.8	1230x863x1183	7.15
	MSF8306GR	115	60	260	2.3	+1~+8	R290	4.2	1318x863x1183	13.38
	MSF8307GR	115	60	320	2.8	+1~+8	R290	4.2	1536x863x1183	17.2
	MSF8308GR	115	60	320	2.8	+1~+8	R290	4.6	1930x863x1183	21.13
	MSF3615GR	115	60	260	2.3	+1~+8	R290	3.5	923x863x1183	8.68
Pizza Prep Table	MPF8201GR	115	60	260	2.3	+1~+8	R290	4.9	1117x840x1035	9.7
	MPF8202GR	115	60	320	2.8	+1~+8	R290	4.9	1701x840x1035	18.5
	MPF8203GR	115	60	360	3.1	+1~+8	R290	4.9	2362x840x1035	28.4

NOTES :If the technical data has any changes, we will not notify you any longer.

W081108202

version number 20200708

