

LCD NVR KITS

USER MANUAL

Please read the manual before operation and keep it for future reference.

(In the manual NVR short for 10.1inch LCD NVR)

Content

1.Safety Caution	3
2.Package Contents	3
3.Camera System Installation	
3.1 NVR Port Introduction.....	3
3.2 IPC Port Introduction.....	4
3.3 Installing Hard Drive.....	5
3.4 System Connection.....	6
4.NVR Operation Steps	7
4.1 Hard Disk Format.....	7
4.2 Recording Settings.....	7
4.3 Video Playback.....	7
4.4 Alarm Settings.....	8
4.5 Video Back Up.....	11
4.6 Network Settings.....	12
4.7 Right Key Button Intruction.....	13
5.Viewing on PC by VMS software	14
5.1 VMS Installation.....	14
5.2 Video Playback.....	15
6.Remotely View On Your Smartphone	16
6.1 Downlad and install the APP.....	16
6.2 Add NVR on the APP.....	16

7.View the NVR on Web Browser	19
8. How to get better signal	20
8.1 Antenna Adjustment.....	20
8.2 Repeat set.....	21
8.3 Use antenna extension cords	22
8.4 Use Cable Connection.....	23
9.How to add a new IPC	23
10.Password Reset	24
11.After Sales Service	25
12.Frequently Asked Questions	26

1.Safety Caution

- 1.1:Please do not put any fluid container on the product.
- 1.2:Please use the product in ventilated environment and prevent blocking the vents.
- 1.3:Check the power supply voltage to prevent damage to the device.
- 1.4:Please use the product under its standard working temperature.
- 1.5:Please do not change the battery by yourself.
- 1.6:Please obey the regulation and policy in your country and area during installation.

2.Package Contents

Thank you for choosing our product.

Here is the list for product and relevant accessories.

What's in the box		
NO.	Name	Qty
1	10.1inch LCD NVR	1pc
2	IP Camera	4/8pcs
3	User Manual	1pc
4	DC12V/2A Adaptor for NVR	1pc
5	DC12V/1A Adaptor for IPC	4/8pcs
6	Wireless Mouse	1pc

3.Camera System Installation

3.1:NVR Port Introduction

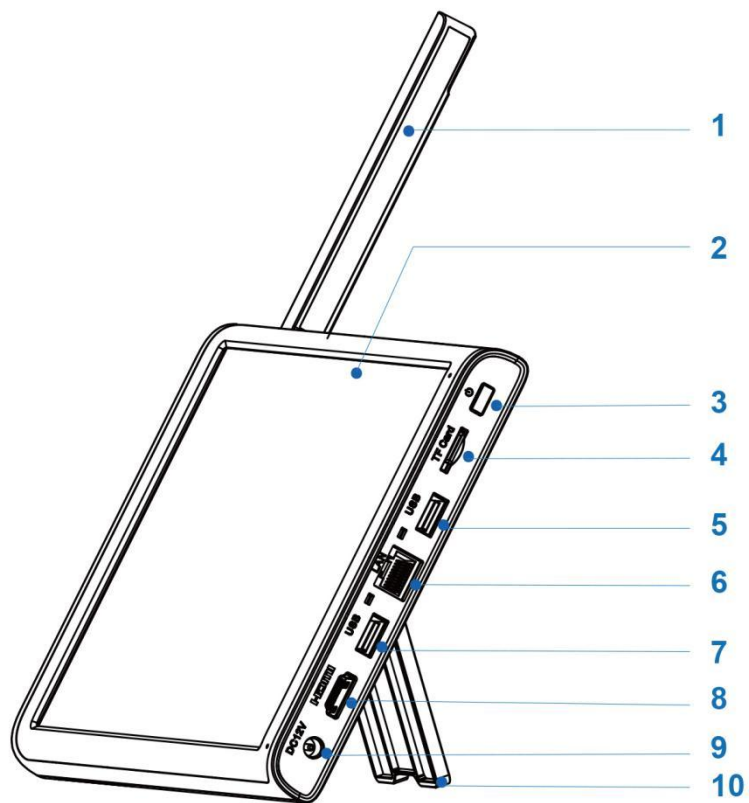

1. Antenna: wireless connection with NVR

2. 10.1LCD Screen

3. Power Button: (Turn on/off the NVR)

4. TF Card Slot: For record on TF card

5. USB Port: To connect mouse/USB Disk

6. Lan Port: Connect Router

7. USB Port: To connect mouse/USB Disk

8. HDMI Port: Connect Monitor

9. Power Port: DC12V/2A

10. NVR Standard

3.2 :IPC Port Introduction

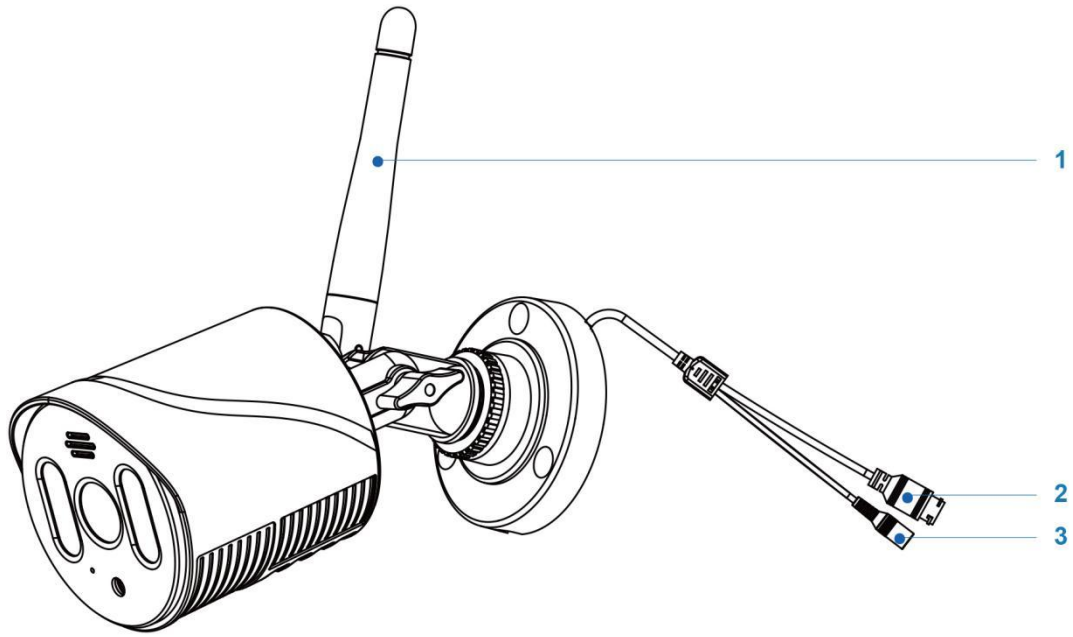

- 1. Antenna: Wireless connection with NVR
- 2. RJ45 Port: Use for IPC and NVR when WiFi is weak.
- 3. Power Port: DC12V/1A

3.3: Hard Disk Install

1. Open the screw on the back of the NVR and take off the HDD cover as below picture:



2. Put the 2.5inch HDD inside as below picture:



3. After fix the HDD please screw it as below picture :

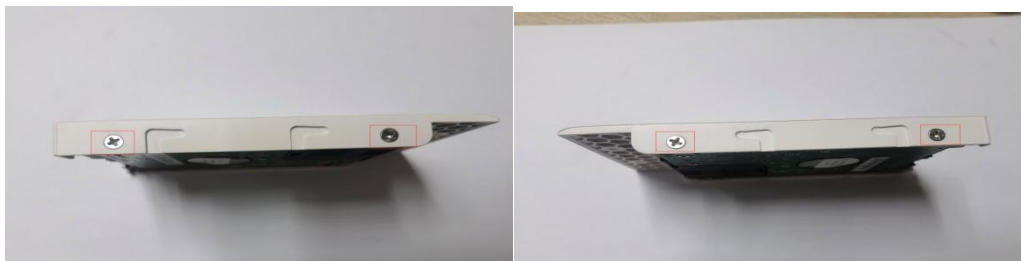

4. Put the fixed hard disk back into the hard disk card position and push the hard disk cover inward to make the connection between the hard disk and the motherboard secure and tighten the screws like below:



Remind: The HDD must be format after installed then can start record . And recommend SEAGATE /Western Data brand etc.

3.4 NVR Connection

For better signal the host should be placed in a high and open condition if possible. The wireless package use an embedded Linux operating system including viewing, recording, playback, video backup and selection of settings. Don't use screws

to fix your IP camera before you see the image on the screen and determine it's the best location.

- 1.Connect the IPC with DC12V/1A adaptor.
- 2.After the wireless package is started normally the IPC will automatically connect to the host and display the image on the screen.
- 3.The USB port can support the wireless mouse for operation.

4.NVR Operation Steps

- 1.The default user name of the NVR is admin and the default password is empty .
- 2.The NVR can only be connected to the network via an Ethernet cable.
- 3.In order to protect your privacy a weak password prompt will pop up after logged in. Please follow the prompt to set the password as soon as possible.

4.1: Hard Disk Format

After install the HDD click right button and enter the Main Menu>Management>Storage to check the HDD status . If its not been format please choose the right HDD and format it .

4.2:Recording Settings

The factory setting defaults to all-day recording if you want to change the settings please go right button>main menu>Recording settings.

- 1.Configure recording: You can check and set the recording type and recording time period.
- 2.Manual recording: all-day recording, including detection recording and alarm recording.
- 3.Turn off recording: never record.



4.3:Video Playback

Click the right button -- Record playback then choose the playback mode ,data and time . Click OK to play the video .

Remind:

Playback button introduction: ▶ Play ; || Stop ; ⏩ Fast Forward 2/4/6/8X

1.File playback: In the playback mode click OK to retrieve the video file and then click the play button to play the video. If you want to play the video at a specific time please select the video time bar below and click on the specific time to replay.

2..Video backup: select the video file in the file list connect to the U disk or mobile hard disk and click Video Backup to back up the video file.

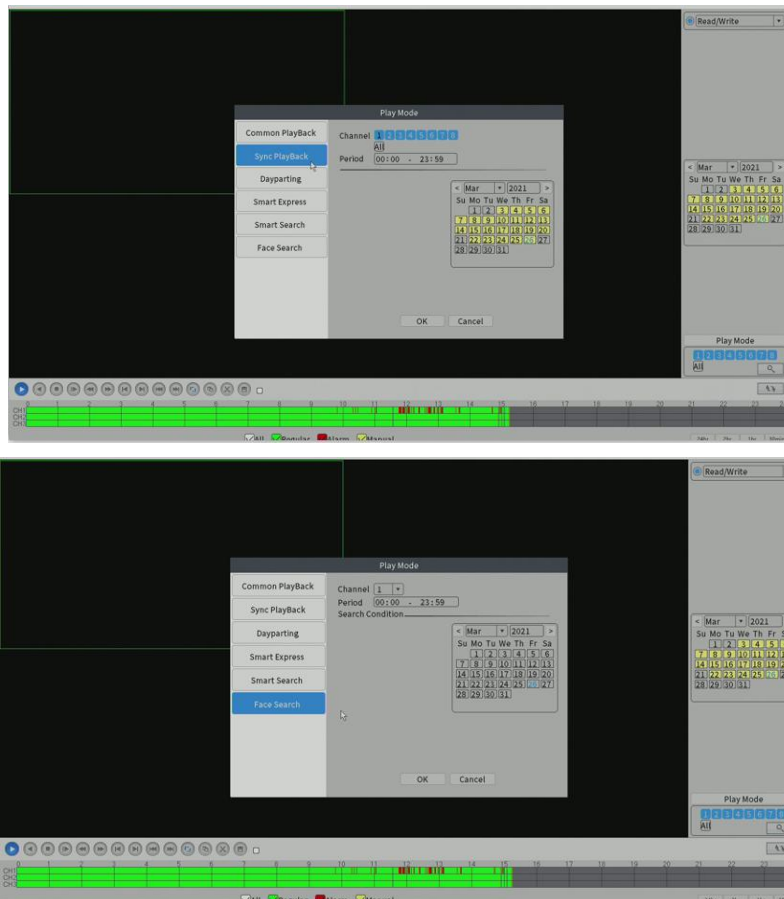

4.4 Alarm Settings

Click the right button to main menu--Alarm Settings to enter alarm settings including intelligent alert system, traditional alarm and exception handling.

1.Intelligent alert system

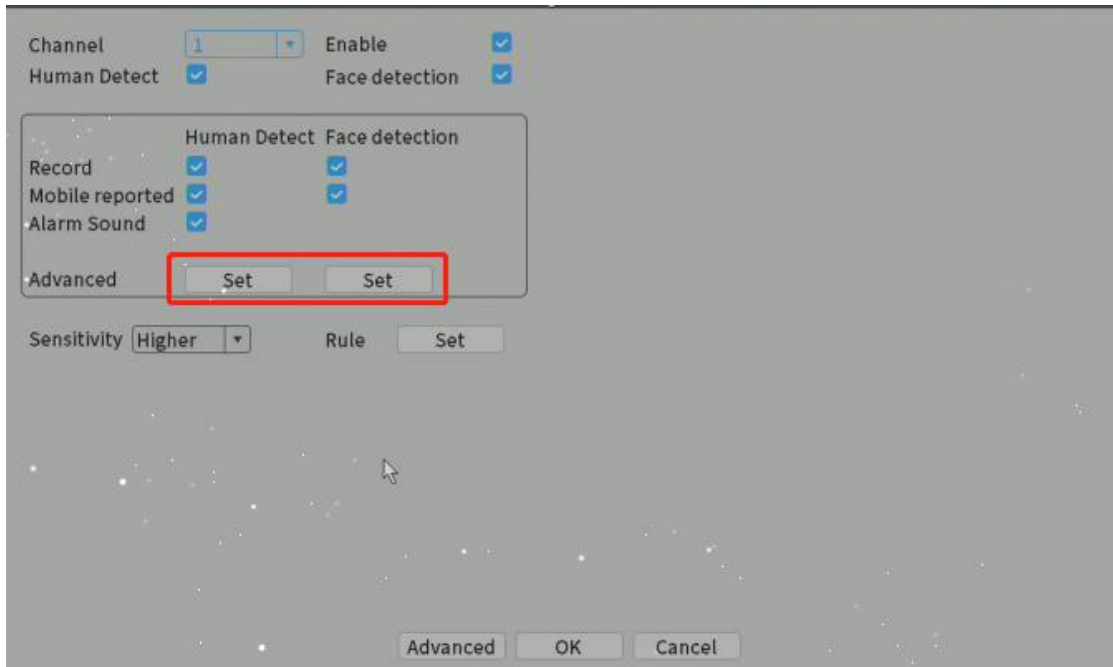
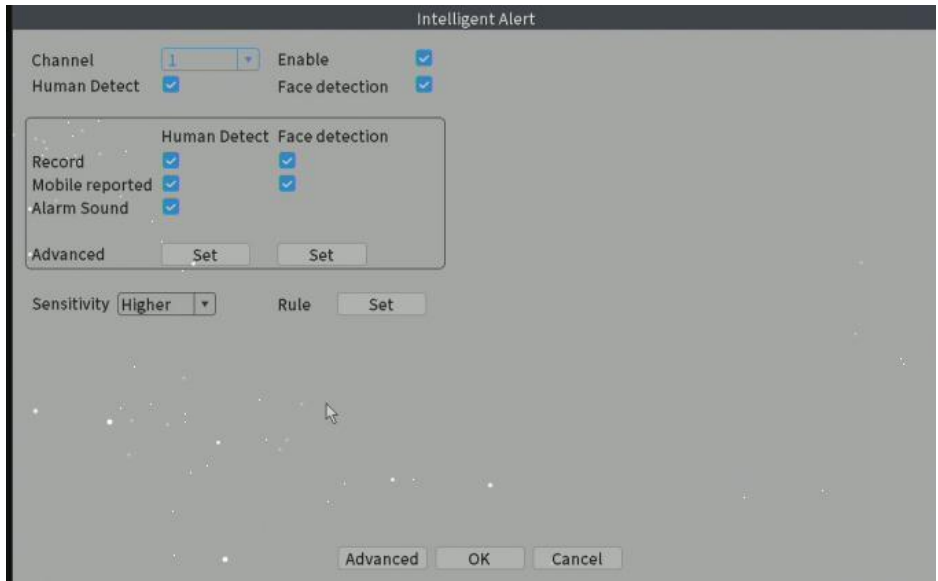

Including motion detection, human figure detection, face detection, the alarm is enabled by default, when an object is detected to trigger motion detection, when a moving object is detected as a human, it triggers human form detection, when a human face is detected in front of the camera, it triggers a human face detection.

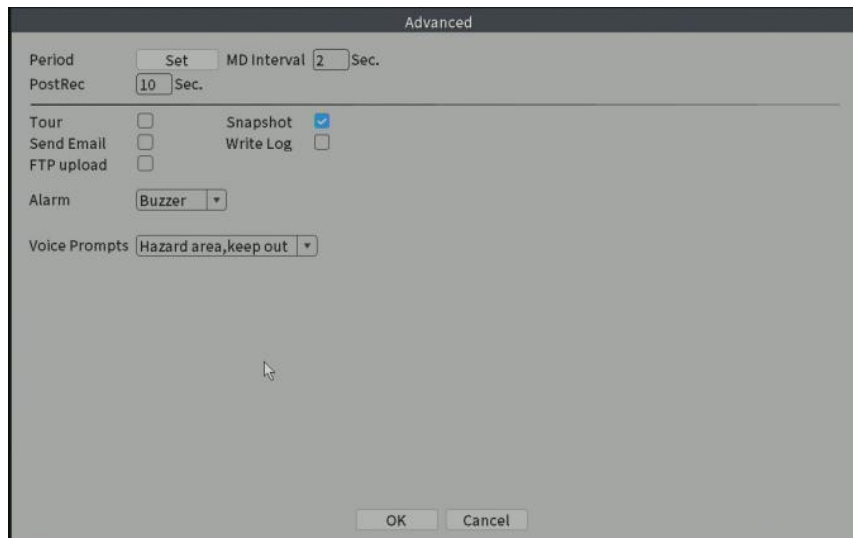

Channel number: optional channel number 1-8.

Sensitivity: The alarm sensitivity is the lowest, low, medium, high, high, and the highest 6 levels are available. The higher the sensitivity the easier it is to trigger the alarm and the false alarm rate will also increase.

Video: Set whether to link video when an alarm occurs.

Mobile phone report: Check this option, the alarm push is enabled in the APP, and the APP will push the alarm message to your mobile phone.

Area: Set the area that triggers the alarm, all are selected by default.

Rules: Click Settings to enter the rules setting interface, you can set alarm trigger rules including warning lines and warning areas.

Alarm sound: set whether to sound out a voice prompt when the alarm is triggered the voice prompt can be selected.

Send Email: After setting Email in Main Menu>Network Settings>Network Service check this item to trigger the alarm and send the email to the set mailbox.

Arming and disarming time zone: Set the time zone of the alarm. The default setting is 24/7 monitoring, you can modify the time.

2. Traditional alarm

Video occlusion the video image transmitted by the front-end camera to the recorder is affected by the outside world, and when the light intensity reaches the set sensitivity parameter the video occlusion alarm will be triggered.

Video loss When the video recorder cannot obtain the video signal transmitted by the front-end camera the video loss alarm is activated.

Alarm input When the recorder receives the alarm signal transmitted by the network camera it starts the alarm input alarm.

Exception handling detects the storage and network status of the video recorder and alarms after detecting the abnormal status.

4.5 Video Back Up

Click the right button to enter main menu --System Settings --Record Back up to start record back up .

Step 1: Insert the U disk-- click Detect and click Backup to enter the backup interface after the U disk is detected.

Step 2: Select the channel ,video type and search time and then click search to display the video list.

Step 3: Check the video files that need to be backed up and click Start to perform video backup.



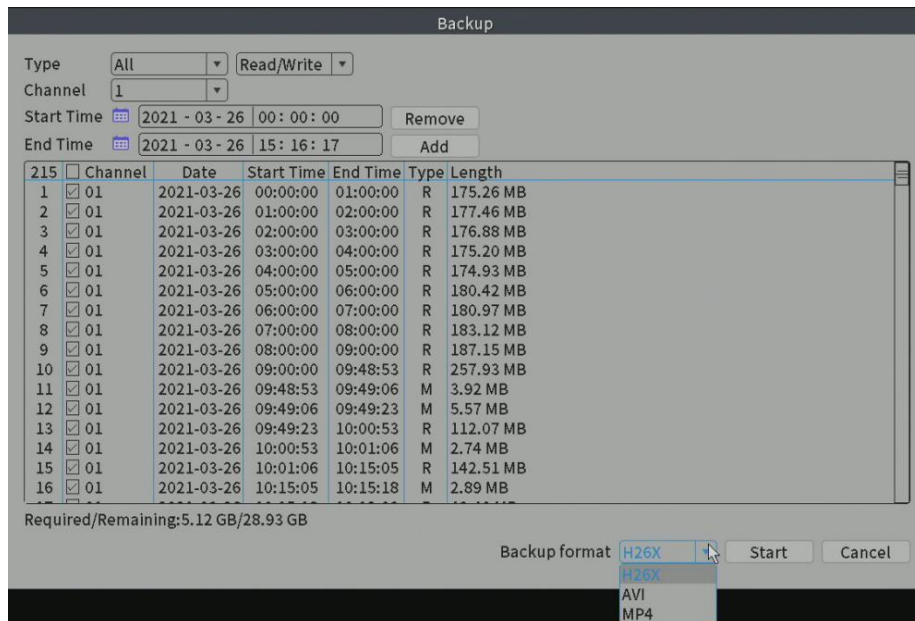

Remind: The back up only support FAT32 format USB Disk

4.6 Network Settings

To watch videos remotely from a mobile device or computer, please make sure that the host is connected to the router with an Ethernet cable first, and then enter the main menu--network settings page to check the IP address, network port etc.

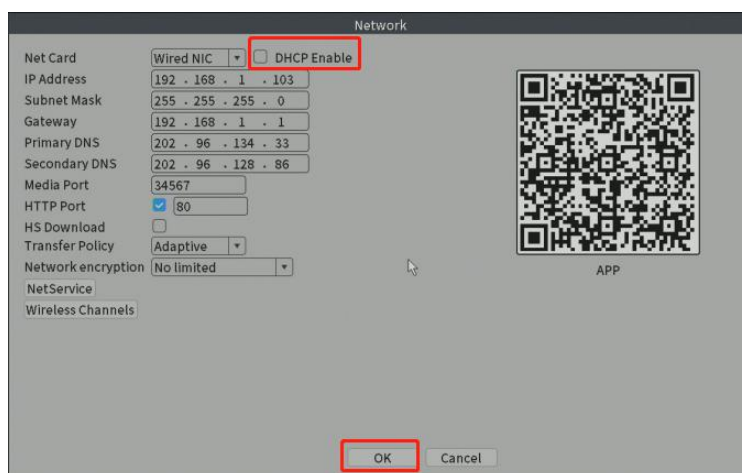

You can use the right-click shortcut menu network detection page to diagnose whether the network status is normal.

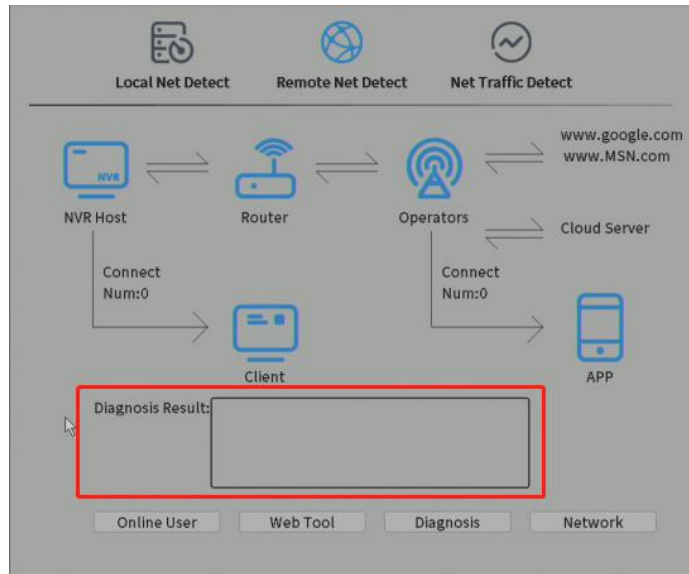

4.7 Right Key Button Introduction

Right-click to display the main menu bar as shown in the figure below and left-click to cancel the display.



Main menu: configure each parameter function of the host, including network settings, system settings, alarm functions and management tools etc.

Wireless configuration: configure and manage IPC through wireless code pairing or wired configuration.

Video control: control the video status of each channel.

Video playback: Play the video files in the hard disk. You can enter the video playback interface through the desktop shortcut menu, or in Main Menu--Video Playback.

Face detection: quickly open and close the face detection display box.

IPC parameters: View and adjust the basic information of IPC, including version information, image settings, advanced and system maintenance items.

Image color: adjustment of image brightness, contrast, saturation and other color parameters.

Screen layout: switch the number of channels displayed on the display.

PTZ control: set zoom, focus, preset point, point inspection and cruise for PTZ camera.

Output adjustment: adjust image style, output volume, margin.

Network detection: detection of equipment network connection status, network sending and receiving rate, front-end disconnection statistics.

Shut down the system: log off, shut down, and restart the device.

5.Viewing on PC by VMS software

Down load the file from the link <https://download.xm030.cn/d/MDAwMDA2NDE=>

5.1 VMS Installation

1.Double click General_VMS_Win32_V2.0.1.7.T.20210309.exe to start the installation.

2.If you have not set any password please use the default user name (admin) and password (admin) to log in to the VMS client.



3.Click on the device management on the homepage to enter the device add and delete page

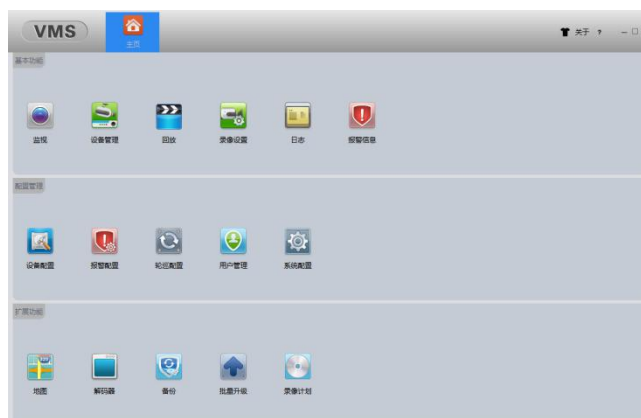

4.By default use IPV4 to search for devices in the network (you can switch to select IPV6 to search for devices in the network) select the device you want to access with VMS and click Add to add the device to the VMS client with the default user name and password. If you

need to change the user name Password access click the small pencil button  at the back of the device to modify.

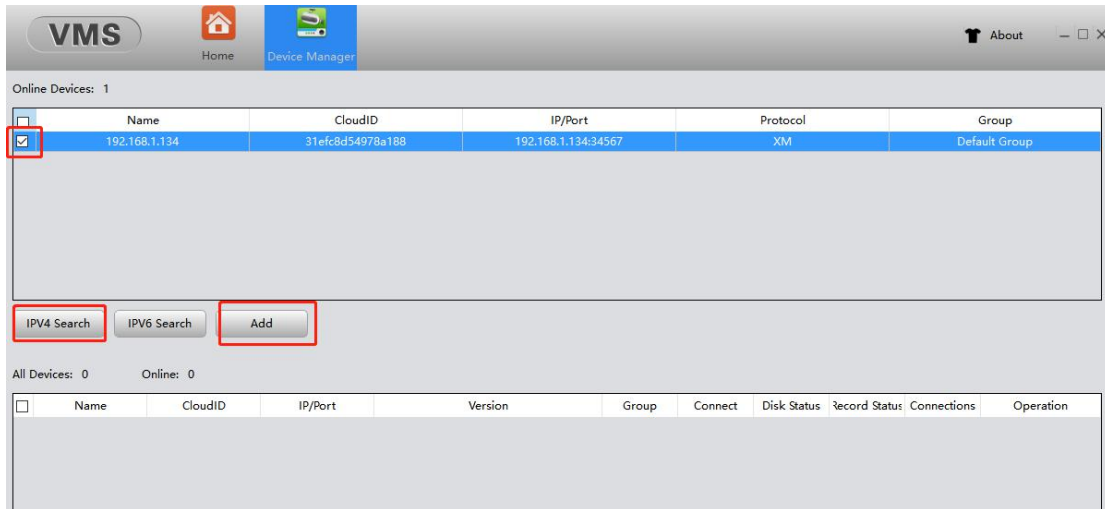

5. After the addition is successful, return to the homepage and click the monitor button and double-click the corresponding channel to display the real-time picture of the corresponding channel. Select the corresponding channel number and right-click the mouse to switch the preview of the primary and secondary streams.

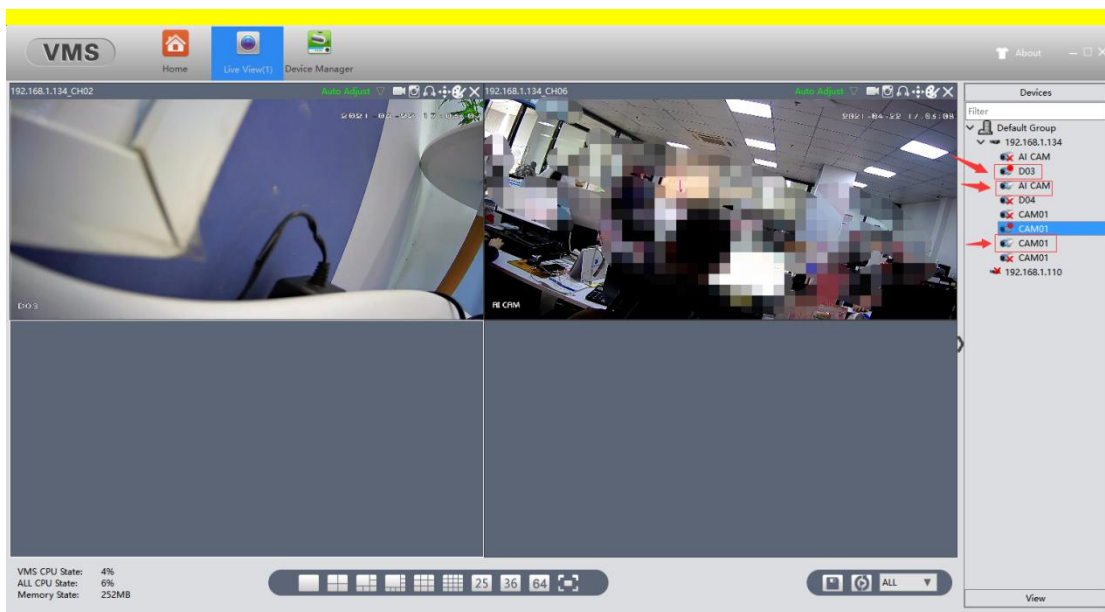

5.2 Video Playback

1. Click the playback button on the homepage to enter the playback interface.
2. Select the corresponding channel and click to search and display the corresponding channel video then double-click the corresponding file to play the corresponding time period video and drag the progress bar to switch the playback time.

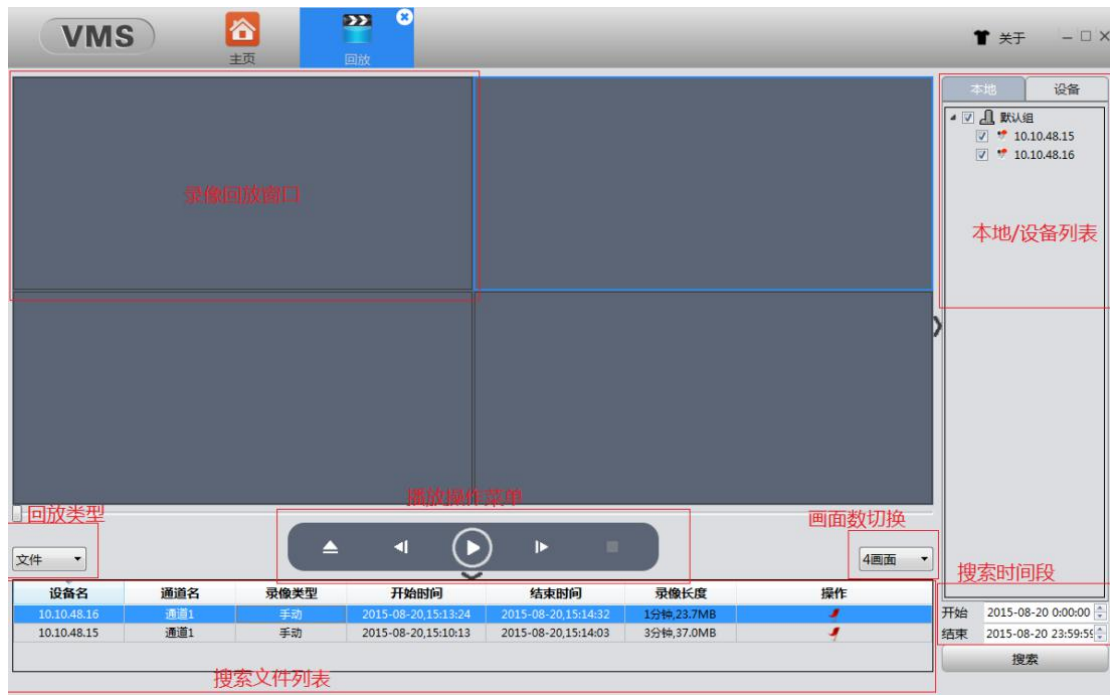

6. Remotely View On Your Smartphone

1. First connect the host system to the router via an Ethernet cable.
2. Confirm that the connection in Nat status is successful. (Main Menu--Administrative Tools--View Version Information Page)

6.1 Download and install the APP

Android users can log in to Google Play Store and Apple users can log in to the APP Store search for "XMEye Pro" to download and install or scan the QR code below to download.



XMEye Pro



下载二维码

6.2 Add NVR on the APP

Run "XMEye Pro" APP and then follow the steps below:

Log in to your account (if you don't have an account before you can click Register Account to register with your phone number or email) -- click the "+" icon in the upper right corner to continue.

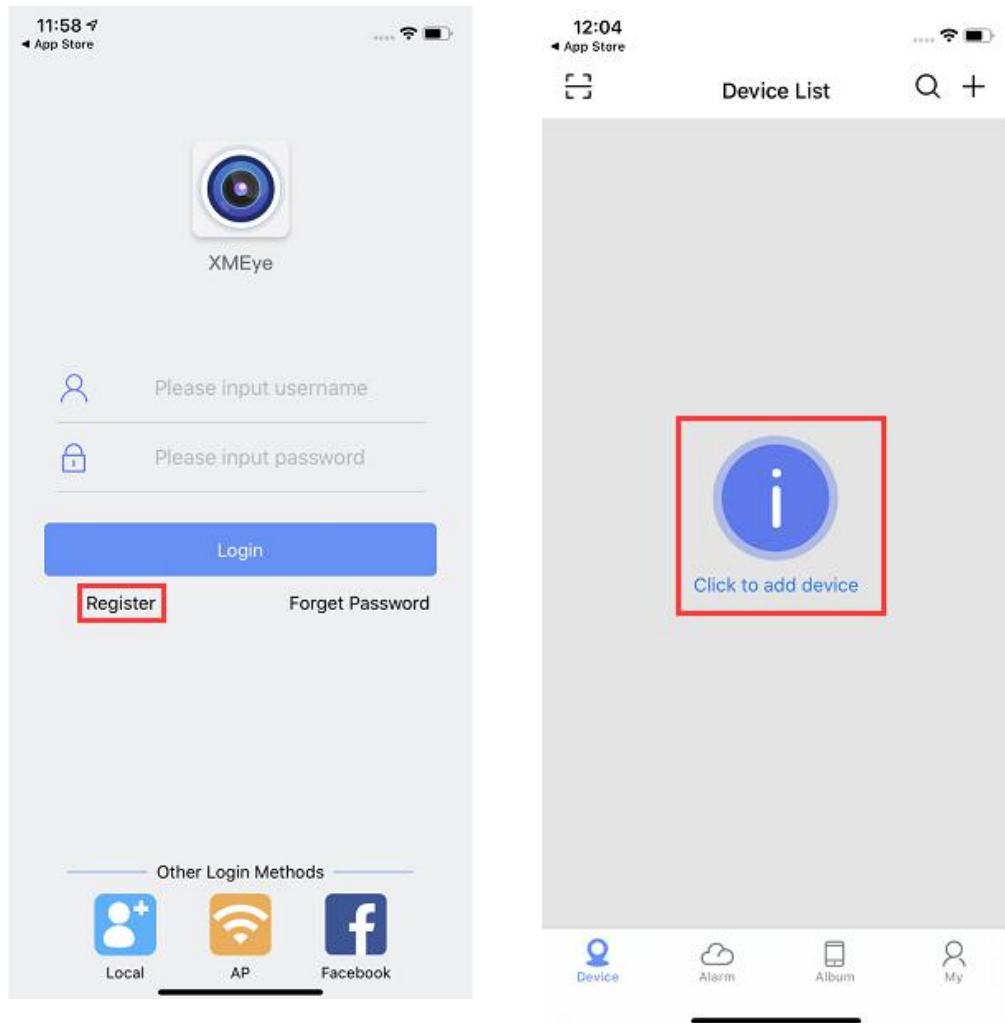

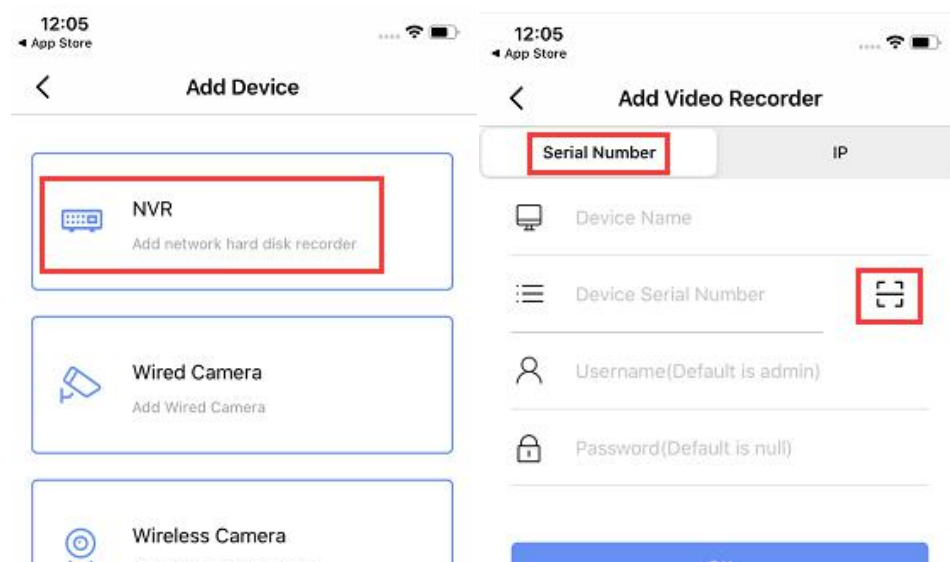

1. Scan the device ID QR code to add the device (move the mouse to the top of the real-time preview interface to display the device QR code). After scanning fill in the user name and password of the current device login account by default for login. If you need to change other user names and passwords please log in Manual modification.



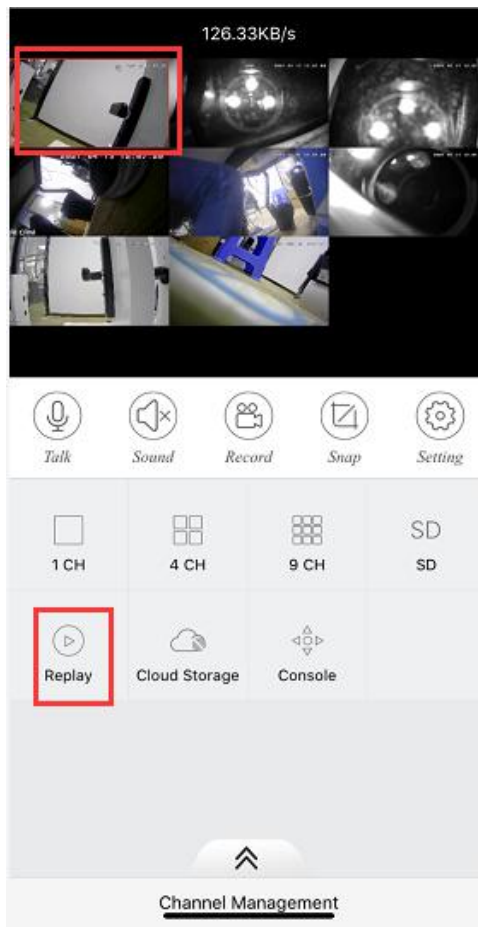
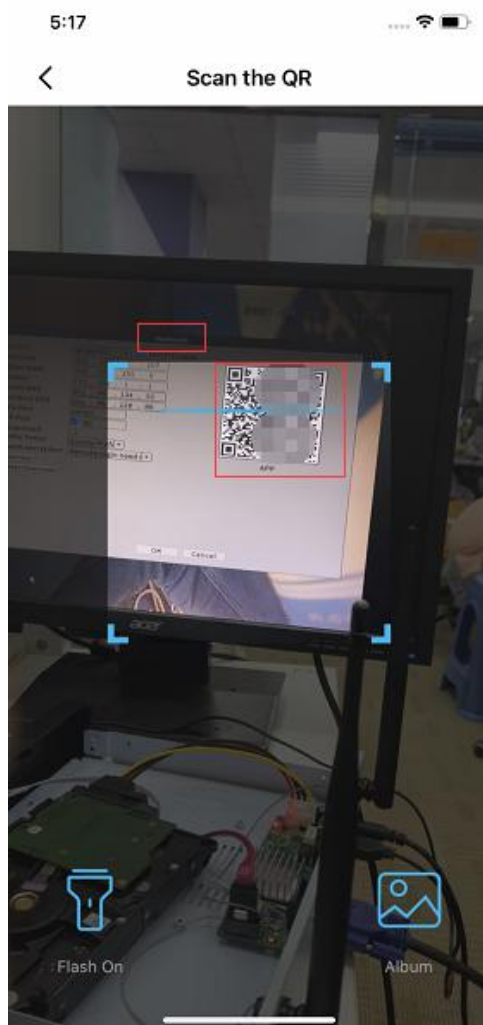

2. Click the thumbnail in the device list to start previewing the video.





 : Click to view cloud storage and alarm messages.

 : Click to view the video in the storage device.

 : Click to choose to talk to the video recorder the camera or publish a broadcast message to the camera.

 : Turn on or turn off the real-time audio of the camera.

 : Click to start real-time recording click again to end real-time recording and save to APP.

 : Click to capture a real-time image to APP.

 : Click to set various parameters of the corresponding channel such as channel name, encoding setting, etc.

7.View the NVR on Web Browser

If the computer and the host device are under the same router, enter the IP address of the device in the address bar of the IE browser (for example: 192.168.1.9) and click [Download Plug-in] download and install the plug-in according to the prompts.

After completion, enter the user name and password in the login interface to view and manage the device.

Note: Internet settings need to be changed to allow plug-ins to be installed on certain computers.

Tips:if your host device network port (HTTP port: 80) has been modified such as 85 please enter 192.168.1.9:85 to enter the IE browser.

If the computer and the host device are under different routers, you can access the device through the cloud website. Log in to the cloud service website: www.xmeye.net

to enter. Click "Newbie Wizard" to complete the registration and log in to the cloud service account you can add devices for remote management and viewing.

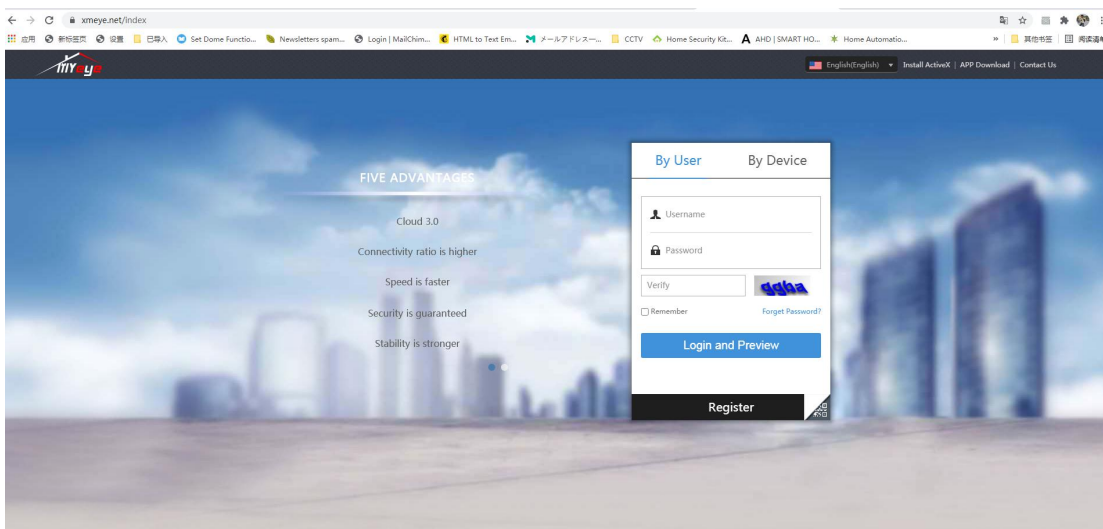

8.How to get better signal

Wireless connection is simple and convenient, but wireless is not a panacea! Because of the characteristics of wireless it is determined that in some complex scenes there will be signal attenuation after passing through obstacles. The signal transmission distance can be expanded by reasonably placing the antenna and bypassing obstacles with the camera cascade method.

Notice:

1. Wireless cascading cannot enhance the signal strength of the wireless package but it can extend the distance of signal relay or turning.
2. Only a reasonable placement of cascaded and cascaded cameras can achieve the purpose of increasing the wireless transmission distance.
3. The cascade setting needs to ensure that the wireless connection is unblocked. In order to ensure the success of the setting it is recommended to confirm the cascade scheme according to the actual use scene, and place the camera near the screen host after setting up the cascade before installing the camera.

8.1Antenna Adjustment

As can be seen from the rod antenna gain diagram below, the antenna's signal coverage is similar to that of an apple. The antenna is located in the center of the apple. The signal around the antenna is strong. The two ends of the antenna are recessed and the signal is weak.

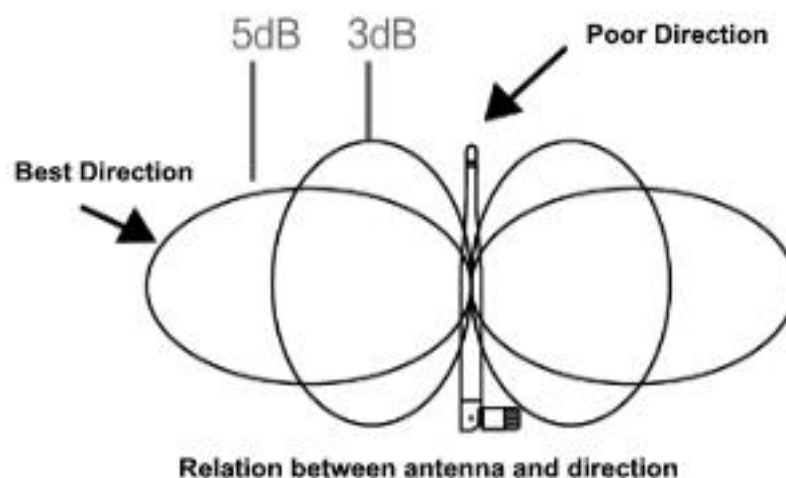

According to the transmission characteristics of the antenna to the signal, in order to ensure

the optimal image transmission effect of the wireless package, the following requirements are required:

1. The antenna of the host and IPC should be placed in a high and open place, and not close to walls, metal, glass and other obstacles, which will affect the signal divergence.
2. The IPC antenna should be placed in parallel with the host antenna as much as possible, so that their maximum radiation direction angles are opposite to form the maximum signal coverage, as shown in the figure below.

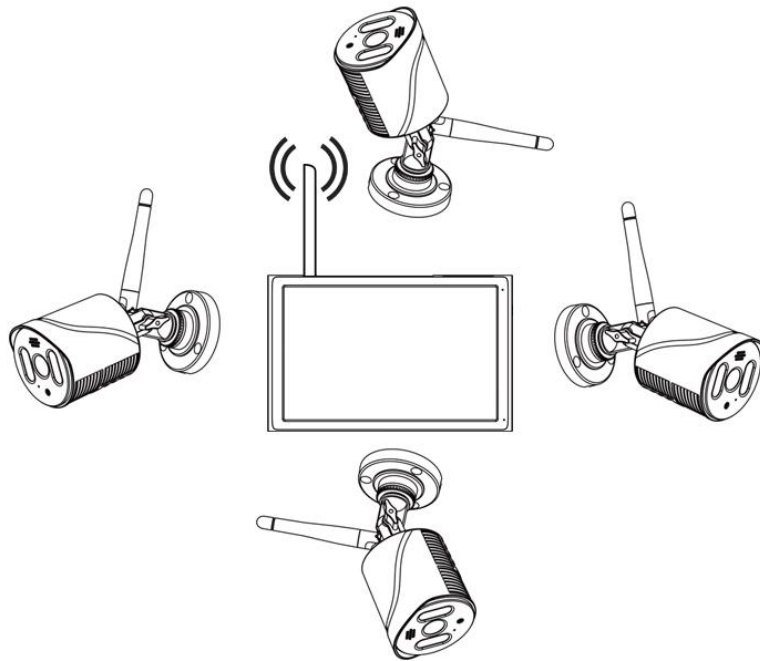

8.2 Repeat set

Three cascade modes are supported: automatic cascade, forced open cascade, and forced close cascade. Under normal circumstances, it is recommended to set automatic cascade. The cascade mode can be set by clicking the corresponding IPC in the pop-up option box. "v" is the current cascade mode of IPC as shown in the figure.

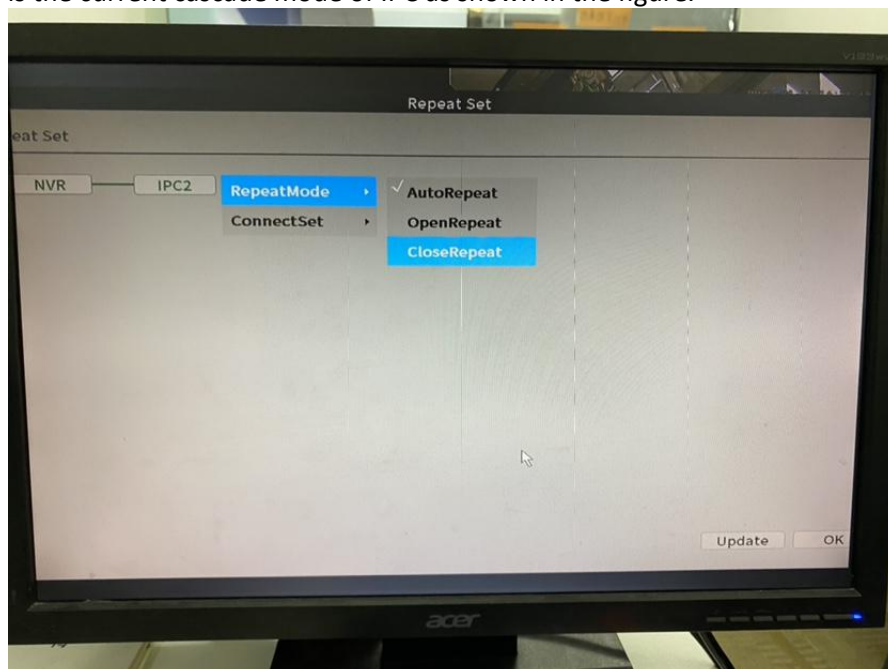

1. Automatic cascading: In the automatic cascading mode, it can achieve up to two levels of cascading, namely host -> IPC1->IPC2->IPC3, where the IPC directly connected to the host (IPC1) and the first cascading device to IPC (IPC2) will automatically turn on the cascade function, the font of the IPC corresponding to the cascade function is green, and the device (IPC3) that is cascaded to the IPC at the second level does not turn on the cascade function, and the font of the IPC corresponding to the cascade function is not turned on is white.

2. Forcibly turn on the cascade: this mode will force the cascade mode to be turned on (remains when restarting). This mode is used for three-level cascade and above. It is not recommended to turn it on, because the WIFI module is not recommended for three-level cascade and above. The transmission load is large.

3. Strong connection cascading: In this mode, the cascading mode will be forcibly closed (restart and still remain). This mode is used when there is a complex environment, the IPC may be cascaded to an undesirable IPC. At this time, it can be closed. Cascaded equipment to prevent incorrect cascading (or use forced connection function).

8.3 Use antenna extension cords

When a camera shows that the signal is not strong due to the wall blocking, you can remove the original antenna, replace the antenna extension cable drill a hole in the wall and place the antenna extension cable through the wall or around the wall. The location of the screen host signal is strong.



8.4 Use Cable Connection

The wireless package has been coded at the factory, and the image can be displayed after power on. However, the wireless signal transmitted by the host has a range. When the camera is not within the range the IPC cannot connect to the screen host via WiFi. At this time the host can be connected via a wired connection (as shown in the figure below). After the front end is powered on, wait for about 30 seconds to automatically output the picture. After the front end has the picture, unplug the network cable.



9. How to add a new IPC

When you need to add a new camera to replace the original camera, you can add it through two methods: wired code matching and wireless code matching.

Right-click to enter the wireless configuration interface and delete the connection of the

camera that needs to be replaced.

9.1 Wired code

For details, see 8.4 Operating Instructions.

9.2 Wireless code

Click on the wireless code follow the prompts to connect the power adapter to the front camera, wait for the code to complete and automatically exit the code page.

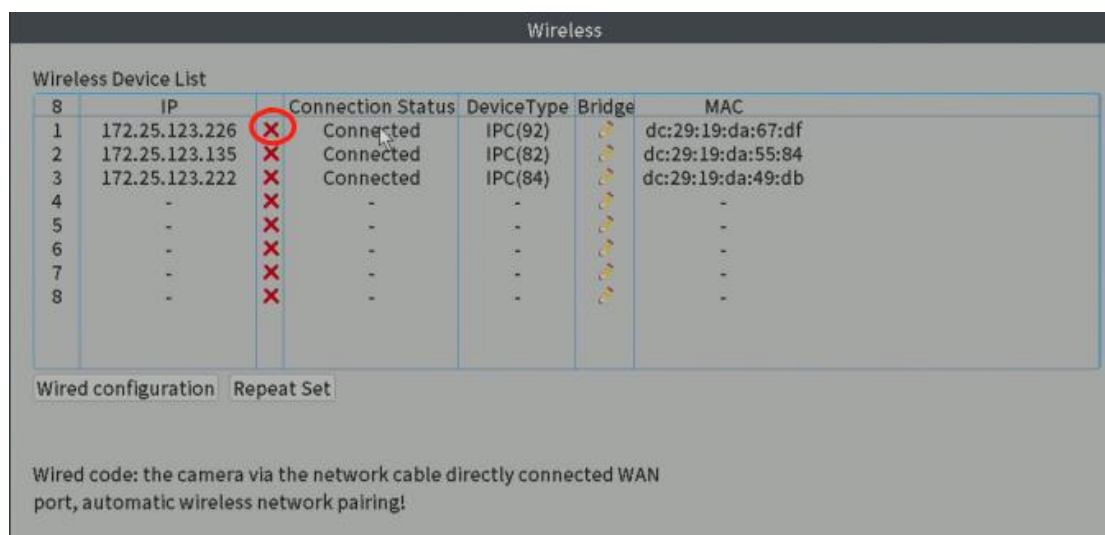

10.Password Reset

When you forget your password, you can click the "forgot password" button on the login system interface to enter the security question answering interface (hint: the default security question is not set you need to enter the main menu> system settings> user management interface to set the account security before you can pass Retrieve the password in this way) after entering the correct answer you can reset the password.

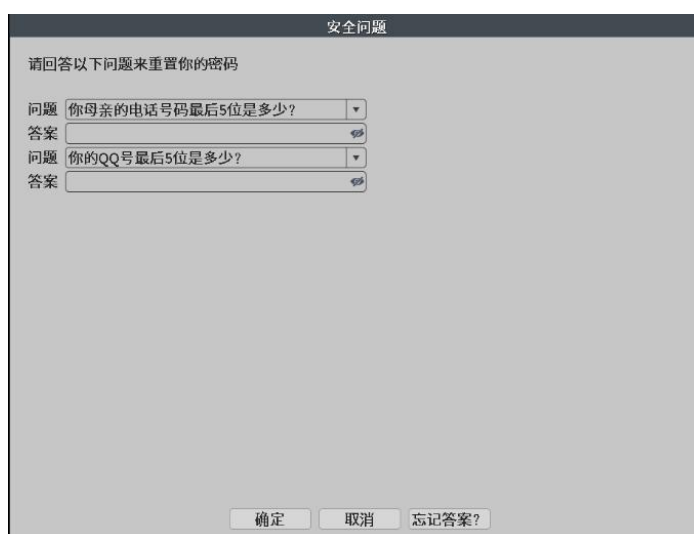

If you forget the answer to the security question, please click "Forgot answer?" to enter

the password reset page through your reserved contact information (if you have not reserved contact information in the user management you will directly enter the password reset interface through the mobile APP) Or click through the APP to enter the reset password page through the mobile phone APP and click Send verification code through the reserved contact information page and it will be sent to your reserved contact information. Through

the mobile phone APP you can click the upper left corner of the APP  interface to scan the QR code of the verification code Then enter the received verification code in the verification code box to reset the password.



11. After Sales Service

Product failures caused by the following conditions are not covered by the warranty:

- a. Product failure due to accident, negligence, disaster, improper operation .
- b. Improper use environment or conditions such as product failure caused by power failure, ambient temperature, lightning strikes etc.
- c. Products that have been repaired by a repair unit not authorized by the manufacturer.

d. Products that have been sold for more than 12 months.

Notice :

- Please refer to the actual product the manual is for reference only.
- The contents of the manual will be updated in real time according to the product without further notice.
- The manual may contain technically inaccurate places or inconsistent with product functions or printed incorrectly. Please refer to the company's final interpretation.

12.FAQ

Question 1: Sometimes there is no live picture.

Answer: This may be caused by WiFi interference causing network congestion, obstructions etc.

1. When you access the live pictures through the cloud, please confirm that the network connection between the router and the host is normal. At the same time, confirm that the router can provide enough Internet bandwidth.To ensure network quality you can restart the router regularly.

2. If you are accessing live pictures on the same network, please confirm that the network connection between the host and the IPC is normal. You can view the WiFi signal strength of the preview interface in real time from the display.

If the WiFi signal is strong but the live pictures are still buffered or lagging, other devices may interfere with the connection between the screen host and the IPC. Please try to remove it or enter the main menu> network settings> wireless channel interface and modify it to another channel or directly check the automatic channel option. After restarting, it will automatically select the strongest signal channel in the current environment.

If the WiFi signal of a channel is weak, move the IPC closer to the host, check whether the WiFi signal strength becomes stronger, and ensure that the IPC antenna is fixed and aligned in the correct direction. If the WiFi signal of all channels is not strong, please slowly move the antenna of the host as described in section 8.1 until they point to the correct direction.

Question 2: There is no live picture when using the browser to access the host

Answer: Go to the main menu> network settings page to check whether the device port is changed from 80 to another port, such as 85. If it is, then enter IP:85 in the IE browser to access the device. For example: the IP address is 192.168.4.6 and the HTTP port is 85, then please enter <http://192.168.4.6:85>. Make sure your browser is installed correctly.

Question 3: The host cannot detect the hard disk.

Answer: Ensure that the host is working properly, Ensure that the hard disk is installed correctly and firmly, Try to replace another hard drive.
Hard drives are consumables. It is recommended to use a branded hard drive to record 24 hours a day, 7 days a week and ensure that important video files are backed up immediately.

Question 4: How to receive push messages from APP?

Answer: Right-click to enter the main menu> network settings> network services, check the mobile phone report and enter the main menu> alarm function and check the mobile phone report corresponding to the alarm.

Make sure you have run XMEye Pro to send push messages to your mobile device.

Make sure that you have enabled the phone to receive alarms in the APP Cloud Events> Push Settings.

Question 5: What should I do when the computer shows that the device is online but the APP shows that it is not online?

Answer: Please make sure you have entered the correct serial number in the APP.

Please confirm that your mobile device network is stable and strong.

If the problem still cannot be solved please send a screenshot of the error problem report to our after-sales team to determine the problem.