

⚠ Caution | Do not mark on the model and other components with pen nor leave printed materials contacted on surface.
Ink marks on the models cannot be removed.

MW19

Difficult Airway Management Simulator

Fiberscope Model

Instruction Manual



Contents

- Introduction P. 1
Manufacturer's Note
DOs and DON'Ts
- Before You Start P. 2
Set Includes
- Preparation
Check points before training P.3
Preparation of the model P.4
Setting of DAM P.5~P.8
- Replacement of the Consumable Parts ... P.9~P.13
- After Training P.14

Manufacturer's note

The Difficult Airway Management (D.A.M.) Simulator Fiberscope model facilitates trainings in insertion and management of a fiberscope. Anatomically correct trachea and bronchi provides realistic view through a scope, allowing recognitions of bifurcations. Varying degrees of challenge to trainees can be set by combinations of controllable degree of mouth opening, changeable limit of neck flexibility and inflatable tongue.

● Features

- Anatomically correct trachea and bronchi that includes trachea bifurcation for segmental bronchi
- Latex free
- Made in Japan

This D.A.M simulator Training Model has been developed for the training of medical and paramedical professionals only. Any other use, or any use not in accordance with the enclosed instructions, is strongly discouraged. The manufacturer cannot be held responsible for any accident or damage resulting from such use. Please use this model carefully and refrain from subjecting to any unnecessary stress or wear. Should you have any questions on this simulator, please feel free to contact our distributor in your area or KYOTO KAGAKU at any time. (Our contact address is on the back cover of this manual)

DOs and DON'Ts

DOs

- Handle the manikin and the components with care.
- Storage in a dark, cool space will help prevent the skin colours from fading.
- The manikin skin may be cleaned with a wet cloth, if necessary, using mildly soapy water or diluted detergent.

DON'Ts

- Do not let ink from pens, newspapers, this manual or other sources contact with the manikin, as they cannot be cleaned off the manikin skin.
- Never use organic solvent like paint thinner to clean the skin, as this will damage the simulator.
- Even if color on its surface might be changed across the ages, this does not affect the quality of its performance.

Set Includes

Before you start, ensure that you have all components listed below.

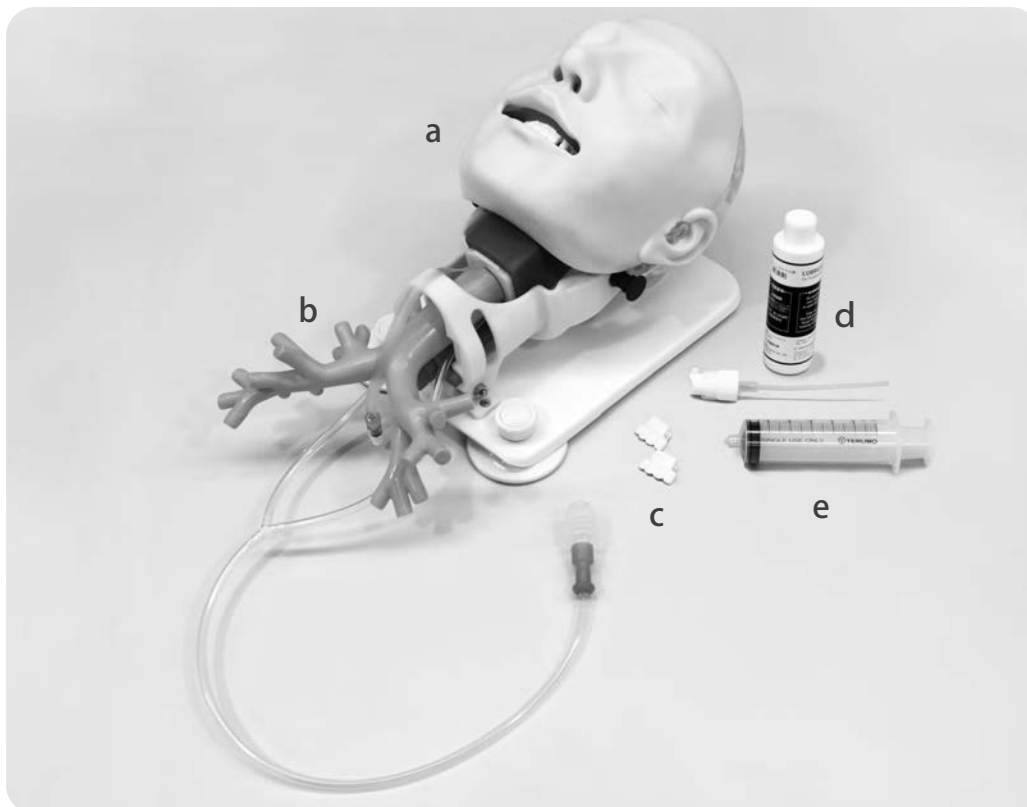

- | | | | |
|-------------------|---|-------------------------------------|---|
| a. Torso body | 1 | d. Lubricant | 1 |
| b. Bronchi part | 1 | e. Syringe (50mL) | 1 |
| c. Upper incisors | 3 | 1 bag for model, instruction manual | |

Consumable parts

code	name
11393-020	Face mask II 1
11392-080	Replacement tongue II 1
11229-050	Lubricant 1



11393-020



11392-080



11229-050

1 Check points before training

1. Open the mouth of the model to check the installation condition of the tongue.
Ensure that the tongue has not fallen out from the pin.
(When the product is delivered, the tongue has already been installed on the model.)



The tongue is correctly installed

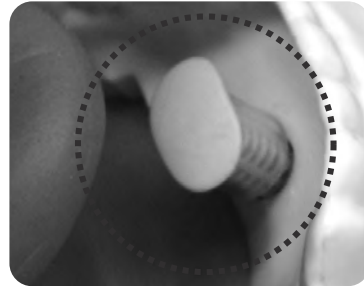

The pin is fixed to the jaw side.

2. Then check whether the tongue fixing part and the throat part are correctly installed.

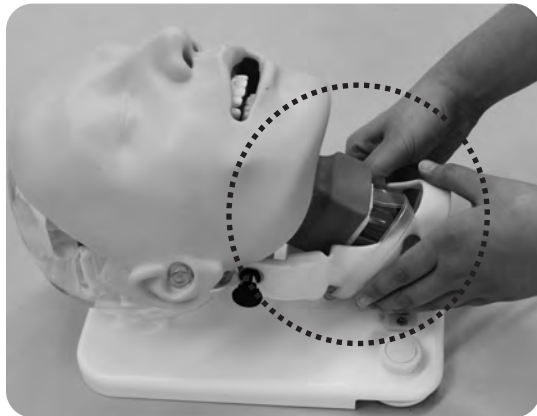

Incorrect installation

(* The photo is taken while the head is removed to allow to see the condition clearly.)

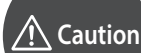
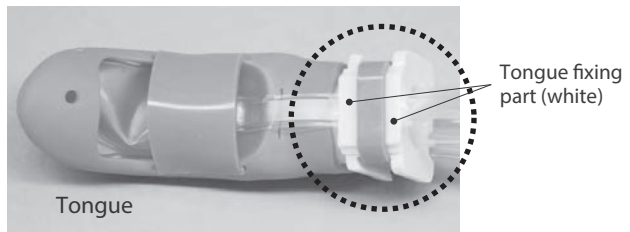
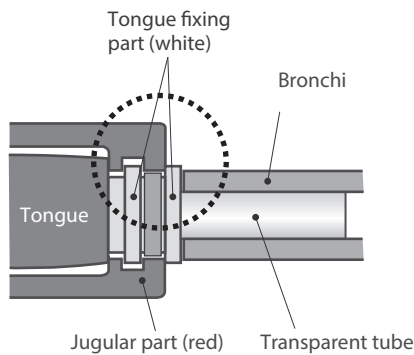

Caution

.....
If the parts enclosed in the dotted circle are not correctly engaged with each other, the tongue will fall out during training.

3. Ready for training session.

1 Fixation of the model

Conduct any training on a table with a flat and smooth surface. Turn the sucker fixing knobs installed in two positions on the base of the model clockwise to fix the model on the table. Turn them counter-clockwise to remove the model.



When removing the model, detach the sucker installed on the back of the base.

2 Connect the bronchi part

1. Connect the bronchi part.

The bronchi part please do not make a mistake in right and left. (The right side of the bronchi part are long.)

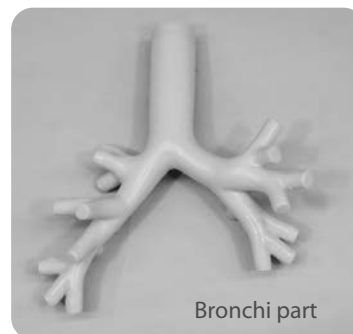

Bronchi part

3 Put enough lubricant

1. Put enough lubricant to the model and the fiberscope before inserting the fiberscope tube.

For nasotracheal airway, spray the lubricant in the cavitas nasi and the tube. For oral route airway, in the mouth and the tube.



Fiberscope tube



Caution

Use the lubricant included in the set. Others like gel type may remain in the model and become irremovable.

This model can be set by combinations of controllable degree of mouth opening, changeable limit of neck flexibility, inflatable tongue and laryngospasm.

Please set it beforehand as needed.

* At the time of delivery setting of DAM is normal entirely.

1 Neck Flexibility

You can select either of two levels of difficulty: normal neck and rigid neck.



Normal

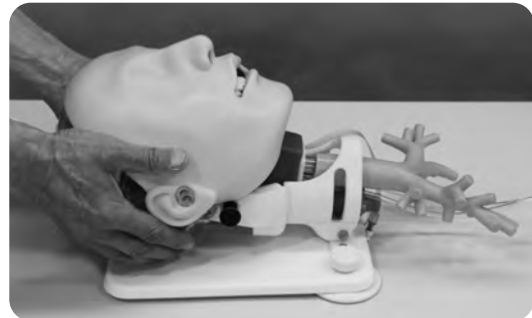

Rigid

Change the range of motion of the neck with the black level-switching knobs on the both sides of the neck of the model.

Turn the knobs while pulling them to the outside to adjust the depth to which the knobs are inserted.

1. To conduct training for the normal condition, align the knobs to the position where you can see the green seal as shown in the photo. Always set up the knobs on both sides identically to each other.

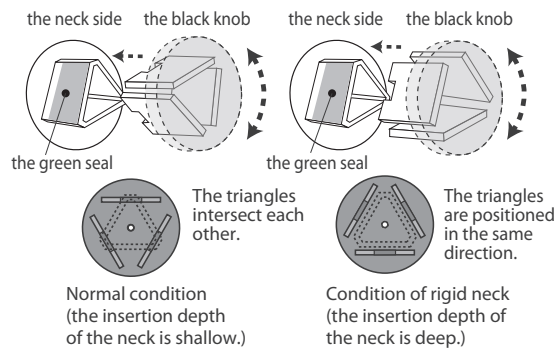

2. To change the setting to the condition of difficulty in neck recurvation, turn the knob while pulling it to align the foot of the triangle to the same direction as that of the receptacle parts on the model. Push the knob until the green seal disappears. You can also lock the setting by returning the position of the head to the direction indicated in the photo below.



Caution

.....
 Conduct any training after setting the knobs on both sides to the same setting.
 If the knobs are set in different settings, it might cause breakage and/or failure.

2 Degree of the Mouth Opening

You can select one of three levels of difficulty: Easy (Normal) [normal condition], Intermediate [mouth opening difficulty level 1] and Difficult [mouth opening difficulty level 2].



Normal (easy)



Intermediate



Difficult

Set the mouth opening limitation with the black level-switching knob on the top of the head of the model. Move the knob up or down while pulling it, and then release it on either of the indicated level lines to lock the setting.

1. To conduct training for the normal condition, align the knob to the Easy (Normal) position.

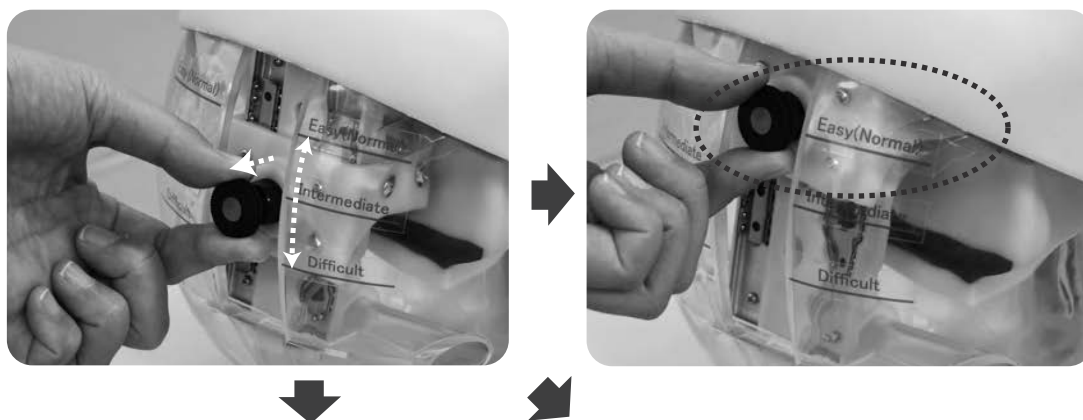

2. To change the condition of the mouth opening difficulty level, move the knob up while pulling it, and then release it on the Intermediate position [mouth opening difficulty level 1] or Difficult position [mouth opening difficulty level 2].

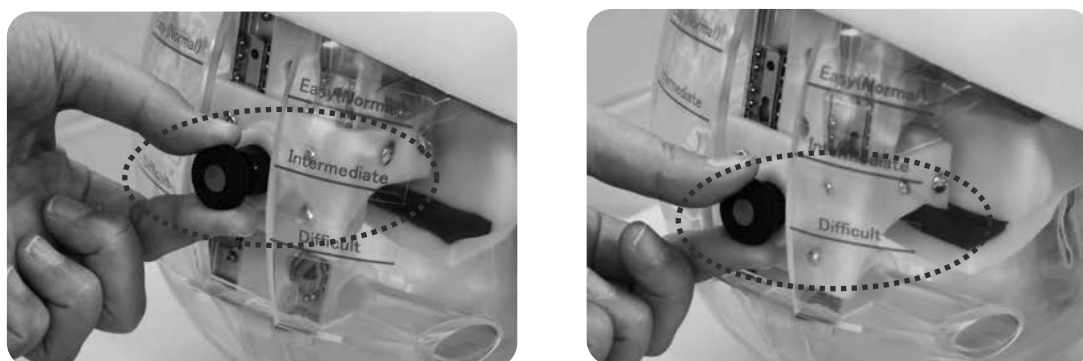

3 Tongue Edema

The size of the tongue can be set in two levels: normal tongue and swollen tongue.



Normal



Swollen

To adjust the condition of the swollen tongue, inject/extract air to/from the tongue by using the attached syringe to change the size of the tongue.

1. To set the tongue to normal condition, do not inject air.
2. To simulate the condition of swollen tongue, intake **20mL** of air into the attached syringe and then connect it to the flat tube located in the neck of the model. The syringe is provided with a lock mechanism. Insert the tip of the syringe to the connector on the end of the tube and then turn the syringe clockwise. After injecting the air into the tongue to simulate swollen tongue condition, turn the syringe counter-clockwise to detach it from the tube.

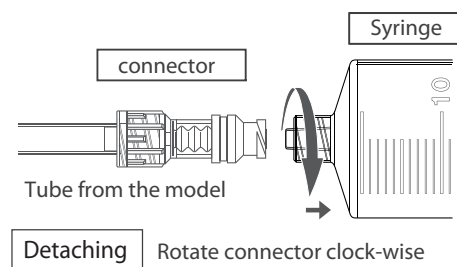
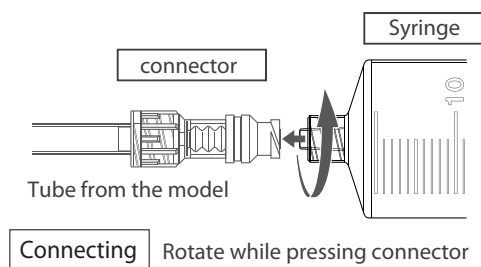

3. To restore the tongue to the normal condition, connect an empty syringe to the tube by using the procedure in the step 2 to extract the air in the tongue to restore the size of the tongue to normal.

4 Laryngospasm

You can select either of two levels of difficulty: normal and laryngospasm.

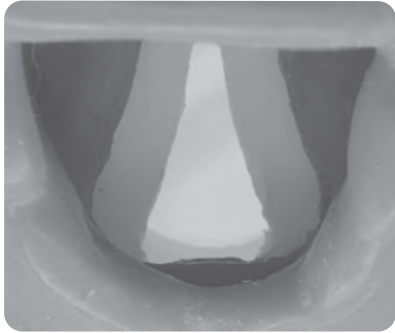

Normal

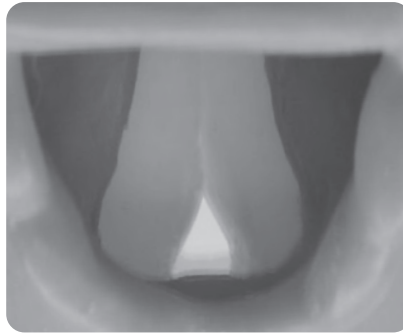

Laryngospasm

By pressing the pump on the end of the tube attached to the main body, you can simulate the laryngospasm.

1. The condition of laryngospasm is simulated while the pump is being pressed. The condition returns to normal when the pump is released.



The condition returns to normal when the pump is released.

Laryngospasm is simulated while the pump is being pressed.



* The photos show the tongue component that is detached from the model to allow visibility of the condition.

1 Upper Incisors

Widen the mouth and then place the protruded part behind the part where the incisor component is installed into the groove on the upper jaw.

Then push up the incisor component toward the front direction until you hear a "click" sound.



2 Tongue

1. Set the range of motion in neck recurvation to the normal condition. Then set the mouth opening limitation to the Easy (Normal) condition.
(Refer to P. 4 and P. 5 respectively for the setting procedures.)



Turn the black knob to the normal position where the green seal appears.

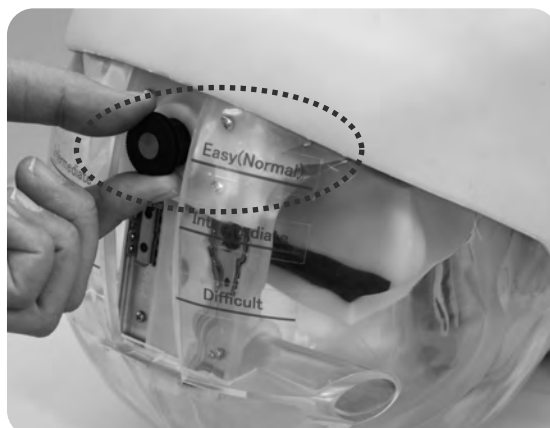

Move the black knob to the Easy (Normal) position.

2 Tongue

2. Remove the face mask from buttons at ears and then remove the mask from the head..



3. Disconnect the transparent tube and bronchi part by pulling the bronchi part. Then disconnect the tube for laryngospasm.

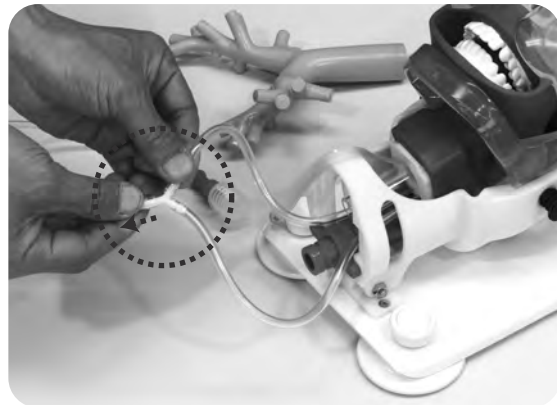
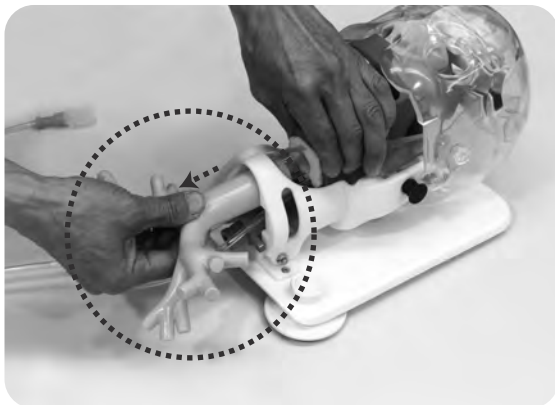

4. To remove the tongue, pull the tongue to one side to expand the hole and remove from the pin.



2 Tongue

5. Disengage the lower part of the throat from the tongue fixing part, then pull down the tongue component to detach. It becomes easy to pull out the whole tongue component when the tongue is pushed into the mouth while pulling it out.

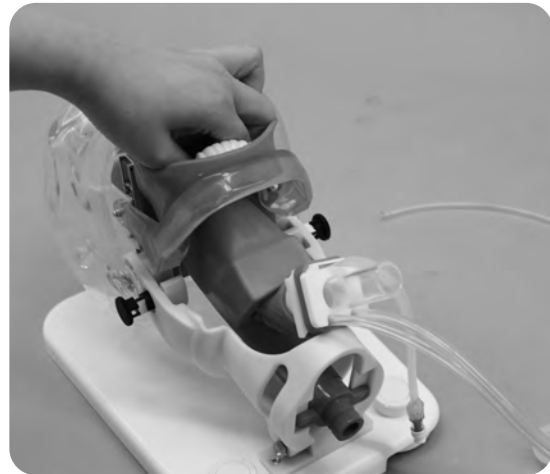
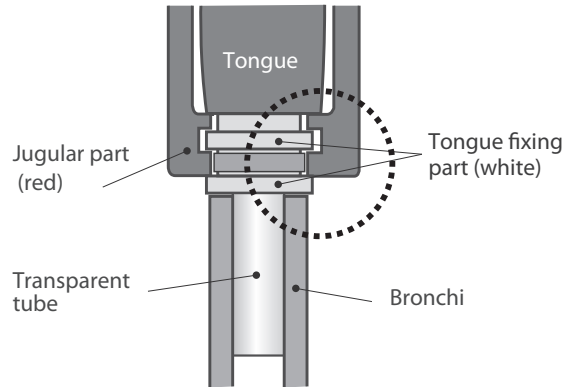

.....
Slowly pull out the tongue component from the throat with care. If it is pulled out forcibly, it could break.

2 Tongue

6. After confirming the tongue direction, insert half of it into the throat from the opening. Insertion is more easily facilitated by applying training model lubricant on it.



7. Push the tongue component into the throat from the throat side. Open the mouth, hold the tongue when a certain portion of it comes into the oral cavity, then pull it until the tip of the tongue touches the incisors. Ensure that the air bag installed in the tongue is not displaced.

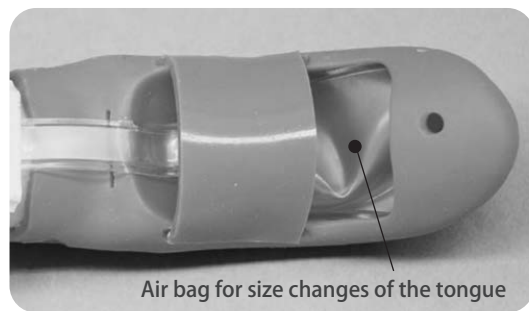

8. Widen the lower part of the throat and engage it with the lower part of the tongue fixing part. Ensure that the entire perimeter is engaged properly.

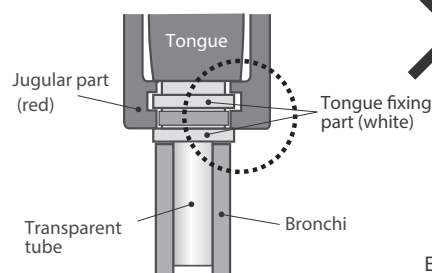

Example of inappropriate installation of tongue component

9. Hook one side of the hole on the tongue to the edge of the pin and pull the tongue in the opposite direction to expand the hole. Once the hole is large enough, fit the pin through the hole to secure the tongue in place.

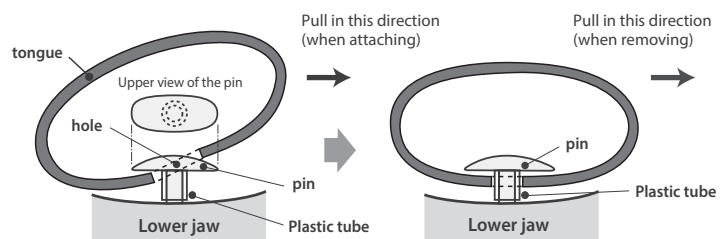

3 Tongue

9. Connect the laryngospasm tube.

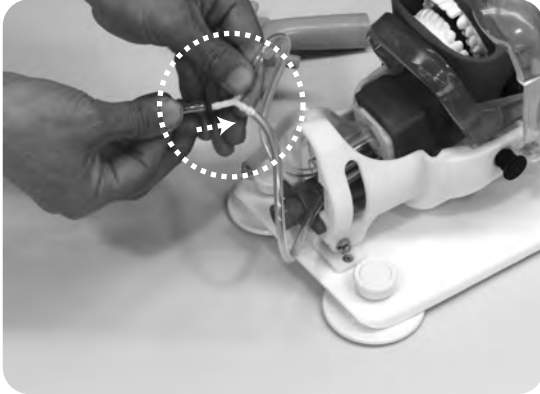

10. Connect the bronchus component.



11. Set the mask on the face.



12. Fit the both of the ear holes on the mask to the head of the model.



4 Face Mask

1. Take off the face mask. Then set the new mask on the face and fit the both of the ear holes on the mask to the head of the model.



After Training

After Training

Clean and remove the lubricant on the face with water or diluted detergent. Talcum powder may be used on the face mask after use to preserve suppleness of the skin and prevent it from being stained. Before storage, ensure that model is dry.





Caution

Don't mark on the model and other components with pen or leave printed materials contacted on their surface.
Ink marks on the models will be irremovable.

- For inquiries and service, please contact your distributor or KYOTO KAGAKU CO., LTD.

KYOTO KAGAKU co.,LTD

<http://www.kyotokagaku.com> e-mail: rw-kyoto@kyotokagaku.co.jp

■ Main Office and Factory

15 Kitanechoya-cho Fushimi-ku Kyoto 612-8388, Japan

Telephone : 81-75-605-2510

Facsimile : 81-75-605-2519

■ KyotoKagaku America Inc.

USA,Canada,and South America

3109 Lomita Boulevard, Torrance, CA 90505 ,USA

Telephone : 1-310-325-8860

Facsimile : 1-310-325-8867

The contents of the instruction manual are subject to change without prior notice.

No part of this instruction manual may be reproduced or transmitted in any form without permission from the manufacturer.

Please contact manufacturer for extra copies of this manual which may contain important updates and revisions.

Please contact manufacturer with any discrepancies in this manual or product feedback. Your cooperation is greatly appreciated.

DAM シミュレータ

気管支内視鏡モデル

取扱説明書



目次

- はじめに P.1
製品の特徴とご使用上の注意
- ご使用前に P.2
セット内容
- 実習の準備
実習前の確認 P.3
モデルの準備 P.4
困難気道症例の設定 P.5～P.8
- 消耗品の交換 P.9～P.13
- 後片付け P.14

● はじめに

このたびは、当社の「DAM シミュレータ 気管支内視鏡モデル」をお買い上げいただきありがとうございます。本製品は、気管支内部を解剖学的に正確に再現した気管支内視鏡トレーニングモデルです。内視鏡挿入時の困難気道症例の設定も可能なため、気管支内視鏡に関する一連の手順や操作をトレーニングできます。

医学教育用実習教材としてご使用ください。

特 長

- 実際の気管支内視鏡を使用した気管支内操作や画像確認の実習が可能なモデルです。
- 気管支内部は気管及び左右の気管支分岐からB¹–B¹⁰気管支分岐部、内部のヒダまで正確に再現。
- 頸部後屈・開口障害・舌肥大・喉頭痙攣などの症例を切り替えることで、様々な挿管困難状況を設定でき、レベルと目的に応じたトレーニングが可能です。
- コンパクト・軽量設計のため、持ち運びが容易です。

必ずお読みください

本来の使用目的以外にはご使用にならないでください。また、取扱説明書に記載された方法以外でのご使用による万一の破損や事故に関して、当社は責任を負いかねますのでご了承ください。

⚠ 注意

● 取り扱いにご注意ください。

特殊軟質樹脂および硬質樹脂を使用していますので、落下や強い衝撃を与えると破損の原因となります。また皮膚部の脱着の際、無理な負荷がかかりますと破損しますので十分ご注意ください。

● 中性洗剤又はアルコールで拭き取ってください。

モデルの汚れは水又は中性洗剤で、汚れが落ちにくい場合はアルコールで拭き、ベビーパウダーを塗布しておいてください。シンナーなどの有機溶剤は、絶対に使用しないでください。

● 印刷物をモデル表面におかないでください。

モデル表面に印刷物などが直接触れないようにしてください。
樹脂にインクが吸収されて消えなくなります。

● ボールペンやサインペンで書き込まないでください。

サインペン、ボールペンなどでモデルに書き込むと、インクが吸収されて消えなくなります。

● 高温多湿を避けて保管してください。

使用後は、高温多湿や直射日光のあたる場所での保管は避けてください。
変形や故障の原因となります。

● 表面が変色する場合があります。

長期間使用されない場合や経年変化で変色することがありますが、ご使用には差し支えありません。

セット内容と各部の名称

ご使用前に、構成品が全て揃っているかご確認ください。

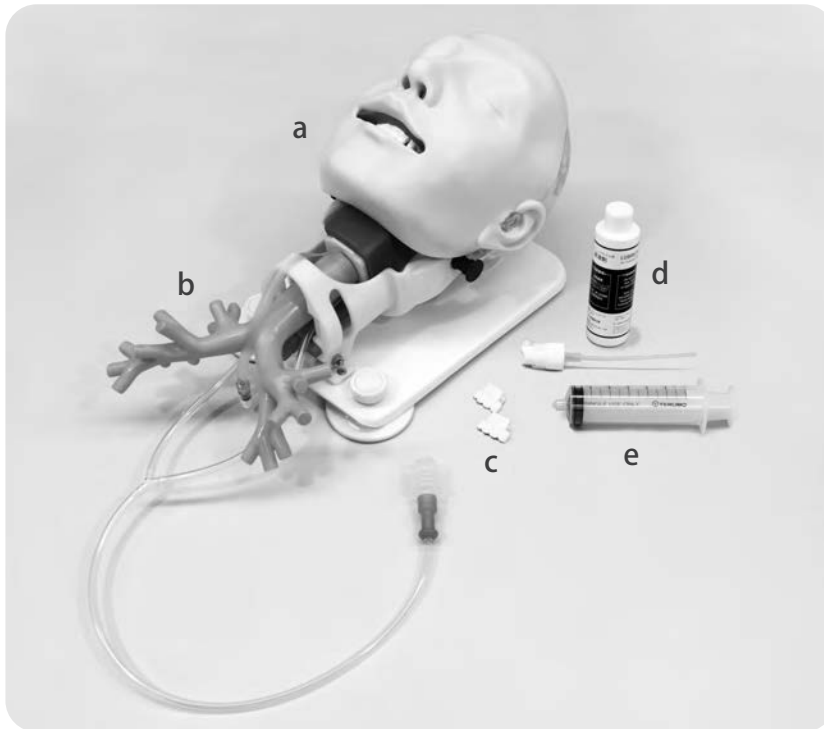

- | | | | |
|---------------------------|-----|------------------|-----|
| a. モデル本体 | 1 点 | d. トレーニングモデル用潤滑剤 | 1 点 |
| b. 気管支部 (納品時は本体とは別に梱包) | 1 点 | e. シリンジ (50mL) | 1 点 |
| c. 上顎側切歯 | 3 点 | 専用バッグ | |
| (1点はモデル本体に取付済、2点は破損時の交換用) | | 取扱説明書 | |

消耗品 一覧

コード番号	部品名
11393-020	マスク(デモ・気管支用) II 1 点
11392-080	舌 II 2 個組

コード番号	部品名
11229-050	トレーニングモデル用 潤滑剤 1 点



11393-020



11392-080



11229-050

1 モデル本体の確認

1. モデル本体の口を開き、舌の設置状況を確認します。
舌先端裏側が下顎にあるピンから抜けていないかを確認します。
(納品時はあらかじめ舌がモデル本体に取り付けてあります)



下顎に取り付けてあるピン

2. 次にモデル本体の舌部固定部と喉部のかみ合わせが正しくセットされているかを確認します。

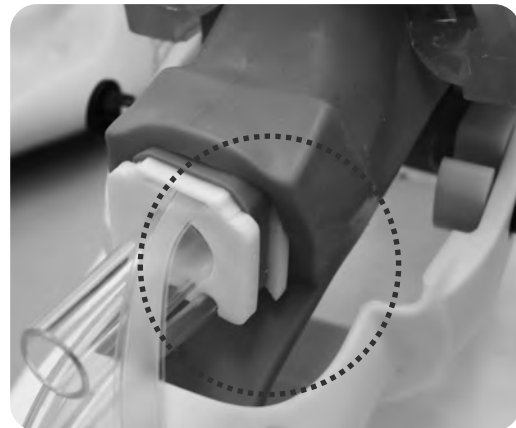

セットが不具合の状態

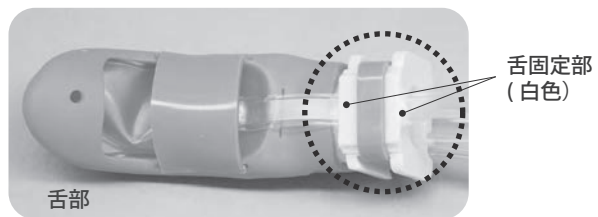
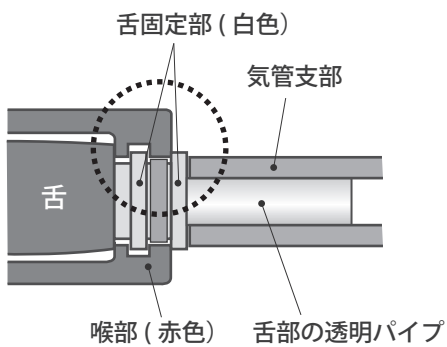

注意

.....
左記の○部のかみ合わせが正しくセットされていないと実習時に舌がずれてしまいます。

1 モデルの固定

実習は平らで平滑なテーブル上で行ってください。

モデル本体のベースに取り付けられた固定用吸盤の2箇所のノブを時計まわり方向に回してテーブルに固定します。取り外す時は逆方向に回して取り外します。



取り外す時はベース裏面にも吸盤が一つ付いていますので、爪等で吸盤をうかせてはけません。

2 気管支部の取付

気管支部を舌部下部の透明パイプに差し込み取り付けます。左右を間違えないようにしてください。(右側の気管支が少し長い状態です)



3 潤滑剤の塗布

気管支内視鏡の挿入実習の前にモデル本体や気管支内視鏡の挿入するファイバーの先端部等に付属のトレーニングモデル用潤滑剤を塗布しておきます。



経口より挿入実習の場合



経鼻より挿入実習の場合



挿入するファイバーの先端部



注意

潤滑剤は付属のものをご使用ください。ゼリー状の潤滑剤などは内部で乾燥凝固して残留する事がありますので使用しないでください。

このシミュレータは、頸部の角度や口の開口、舌の大きさ、喉頭痙攣などを、正常の状態のほか段階的な困難気道症例の設定が可能です。必要に応じて、あらかじめ設定を行ってください。納品時は全て正常の状態に設定しています。

1 頸部後屈の設定

頸部後屈は正常および頸部後屈困難の設定が可能です。



正常

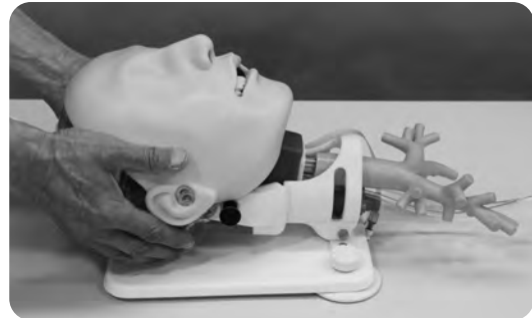

頸部後屈困難

● 設定の方法

モデル本体の頸部側面（左右）にあるレベル切り替え用の黒いノブで頸部の可動域を変更します。ノブを左右外側に引っ張りながら回転させ、差し込み深さを変更し、正常か頸部後屈困難の設定を選びます。

1. 正常の場合はノブを写真のように緑のシールが見える位置に合わせます。必ず左右両側を同じ設定にしてください。

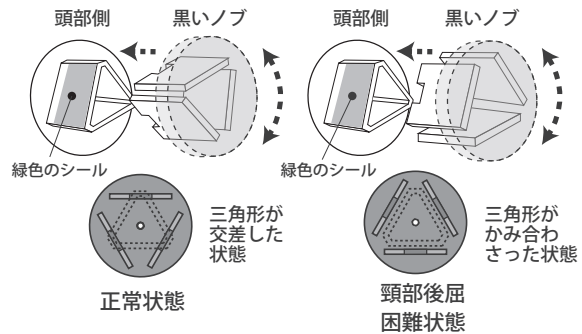

2. 頸部後屈困難の状態に切り替える場合は、ノブを引っ張りながら回して、三角形の脚部が本体側の受け具と同じ方向になるようにします。次に緑のシールが見えなくなるまでノブを内側に押し込みます。頭部を下の写真の矢印の方向に戻す事でも設定のロックがかかります。



注意

左右のノブは、必ず同じ設定で実習を行ってください。
左右を異なるレベル位置に設定し実習を行うと、破損や故障の原因になります。

2 開口制限の設定

開口制限は正常以外に2段階の開口困難レベルの設定が可能です。



正常 Normal (easy)



開口困難レベル1 (Intermediate)



開口困難レベル2 (Difficult)

● 設定の方法

モデル本体の頭頂部にあるレベル切り替え用の黒いノブで開口制限を設定します。ノブを手前側に引っ張りながら上下させ、表示してあるレベルライン上で、ノブから手を放してロックします。難易度は Easy (Normal) [正常]、Intermediate [開口困難レベル1]、Difficult [開口困難レベル2] の3段階の設定が可能です。

1. 正常の場合はノブを Easy (Normal) の位置に合わせます。

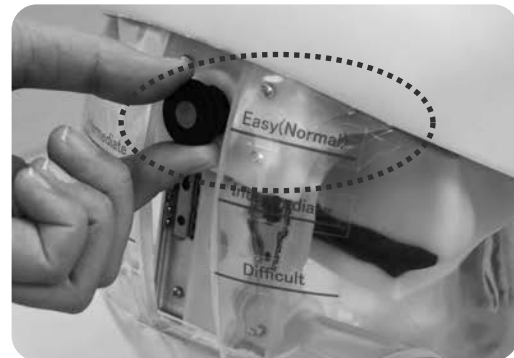

2. 開口困難状態に切り替える場合は、黒いノブを手前に引っ張りながらノブを下方に移動させ Intermediate もしくは Difficult の位置に合わせます。



3 舌の肥大の設定

舌の肥大は正常と巨大舌の設定が可能です。



正常



巨大舌

● 設定の方法

舌の肥大の設定は、付属のシリンジを使用し、舌に空気を注入・排出して舌の大きさを変化させます。

1. 舌に空気を注入しない状況が正常の状態です。
2. 巨大舌の設定は、あらかじめ付属のシリンジに 20mL の空気を入れ、モデル本体の頸部にある平型のチューブに接続します。シリンジはロック方式になっており、シリンジの先端をチューブのコネクターに差し込み、時計まわりにシリンジを回して接続します。空気を注入し舌を巨大舌状態にしたら、シリンジを逆方向にまわしてチューブからはずします。

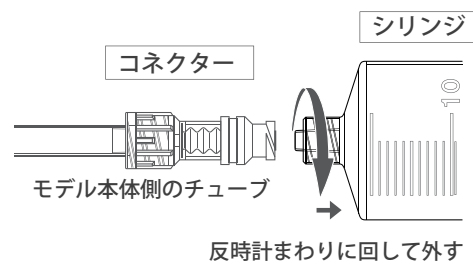
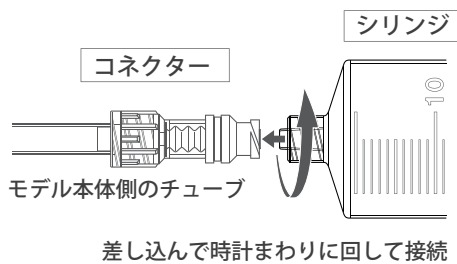
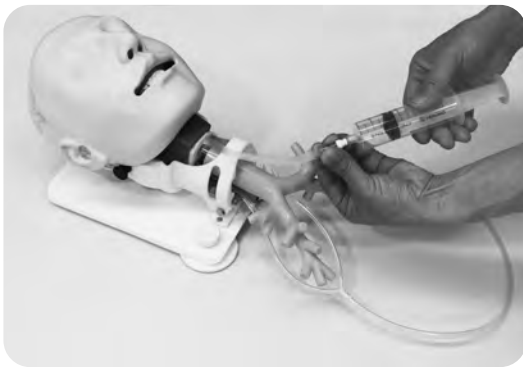

3. 舌を正常の状態に戻すには、空気を抜いたシリンジをチューブに接続し、シリンジで舌にたまっている空気を抜いて、舌の大きさを正常にします。

4 喉頭痙攣の設定

正常と喉頭痙攣状態の設定が可能です。

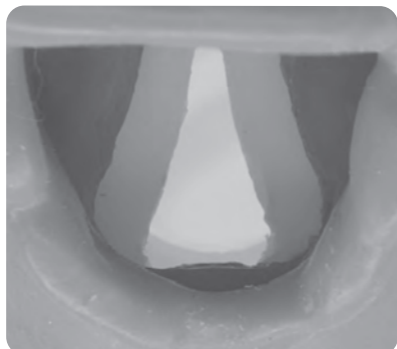

正常

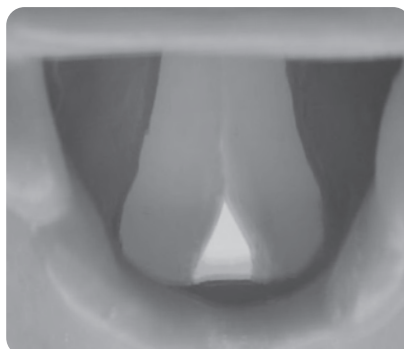

喉頭痙攣

● 設定の方法

喉頭痙攣の設定は、本体に付属しているチューブの先のポンプを指で押して設定します。

1. ポンプを押した状態が喉頭痙攣で、指を離すと正常の状態に戻ります。

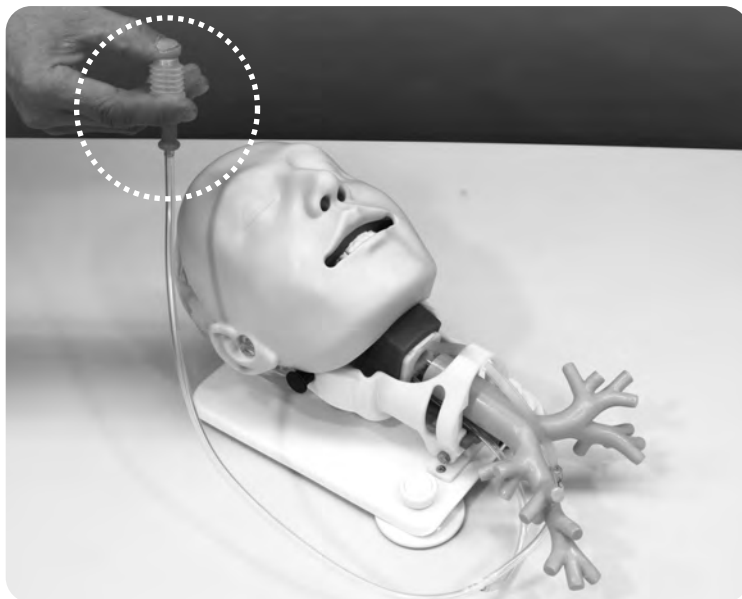

ポンプから指を離すと正常状態になります。

ポンプを指で押すと喉頭痙攣の状態になります。



※写真は説明を解りやすくするため舌部をモデル本体から取り出した状態で撮影しています。

1 上顎側切歯の交換

口を上げて、切歯の取付部後ろ側の出っ張りを上顎の溝にひっかけます。
続いて切歯を手前側にパチンと音がするまで押し上げ、上顎に切歯を固定します。



2 舌の取り外し

1. 顎部後屈の困難レベルを正常の状態に設定します。次に開口制限の困難レベルを Easy (Normal) に設定します。(それぞれ困難度レベルを正常に戻す手順は P4 ~ P5 を参照ください。)



黒いノブを回して緑のシールが見える正常の位置に設定



黒いノブを移動させ Easy (Normal) の位置に設定

② 舌の取り外し

2. 左右の耳の留め具からマスクをはずし、頭部よりマスクを取りはずします。



3. 気管支をはずします。次に喉頭痙攣用チューブをはずします。

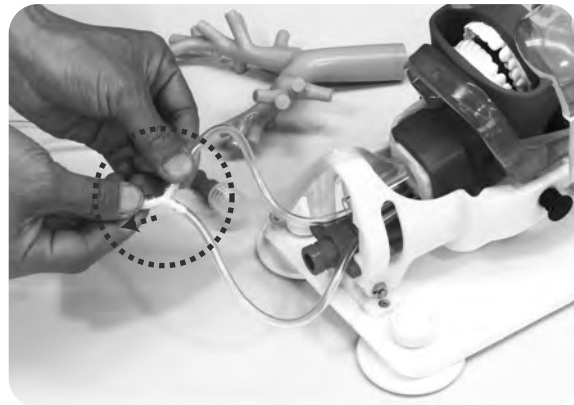
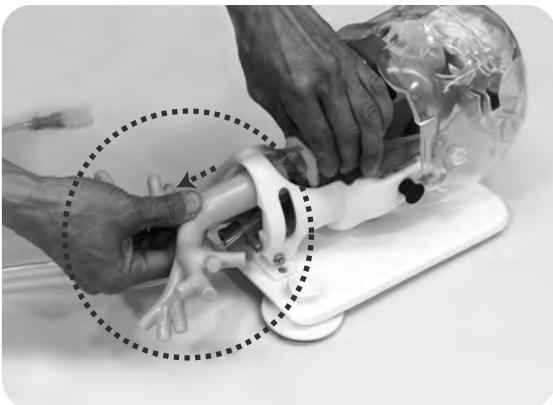

4. 舌の片側を引っ張り穴を広げて、下顎に付いているピンから舌をはずします。



② 舌の取り外し

5. 喉部下部を少し引っぱりながら舌固定部を引き出すようにして引っ掛かり部をはずし、舌部を下方方向に引き抜きます。
途中で口側から舌部を中に押し込んでおくと、舌部全体が抜けやすくなります。

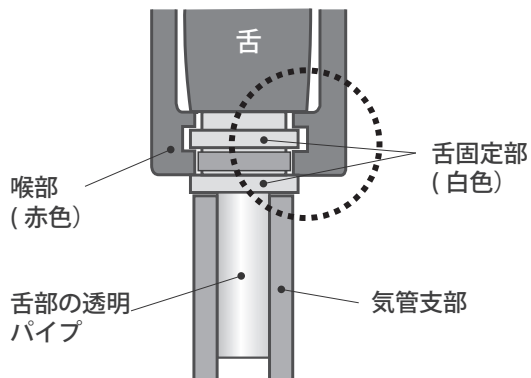

注意

.....
舌部を喉部から取り外す場合は、ゆっくりと丁寧に行ってください。無理に引っ張ったりすると破損の原因になります。

3 舌の取り付け

1. 新しい舌部を用意し、舌の向きを確認して喉部の中に半分くらいまで挿入します。あらかじめトレーニングモデル用潤滑剤を舌部に塗布しておくとも挿入しやすくなります。



2. ある程度舌部を喉部に挿入したら、口を開き口腔内に出てきた舌の部分を持ち、舌の先端を切歯にあたる位置まで引っ張ります。この時、舌の中に設置してある舌肥大用空気袋がずれないように注意します。

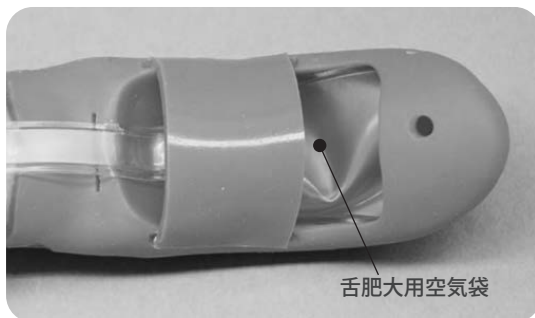

3. 喉部下部を広げて、舌固定部の引っ掛かり部をはめ込みます。周囲から見てしっかりはまっているか確認してください。

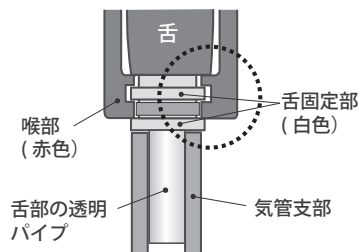

舌部設置不具合の例

4. 舌先端部の穴の片方をピンの片側のエッジに被せ、反対方向に舌をひっぱると穴が広がってピンに被さり、舌が下顎側に固定されます。

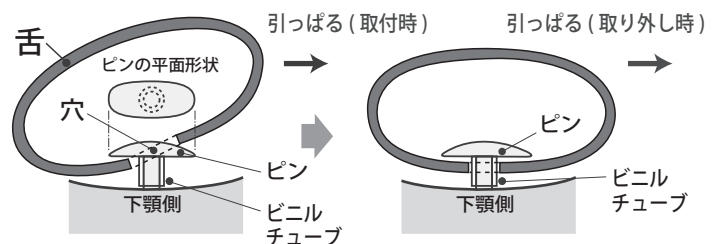

3 舌の取り付け

5. 喉頭痙攣用チューブを接続します。

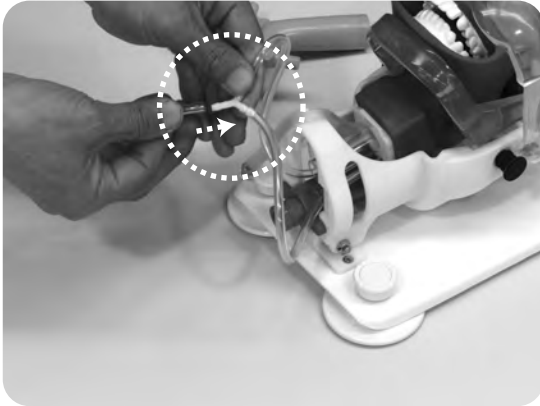

6. 気管支部を接続します。



7. 頭部にマスクをかぶせます。



8. 左右の耳の留め具にマスクの穴を通します。



4 マスクの交換

1. マスクの交換も舌の交換で行ったように耳の留め具からマスクを取り、新しいマスクと交換します。



後片付け

後片付け

実習終了後は、水または中性洗剤でモデル本体の汚れや塗布した潤滑剤などをきれいに拭き取り、マスク部はベビーパウダーを塗布して、十分乾燥させてから保管してください。





注意

モデル表面に印刷物などが直接触れないようにして下さい。
樹脂表面にインクが吸収されて消えなくなります。



株式
会社

京都科学

URL ● <http://www.kyotokagaku.com>
e-mail ● rw-kyoto@kyotokagaku.co.jp

■本社・工場

〒612-8388 京都市伏見区北寝小屋町15番地
TEL: 075-605-2510 (直通)
FAX: 075-605-2519

■東京支店

〒113-0033 東京都文京区本郷三丁目26番6号
NREG本郷三丁目ビル2階
TEL: 03-3817-8071 (直通)
FAX: 03-3817-8075

2018.04