

Adam, Rouilly

SERVING MEDICAL EDUCATION WORLDWIDE

AR58 DESPERATE DEBRA® - IMPACTED FETAL HEAD SIMULATOR

Instruction Manual



Thank you for purchasing this **AR58 Desperate Debra® - Impacted Fetal Head Simulator**.

Developed in collaboration with **Dr Graham Tydeman**, Consultant in Obstetrics and Gynaecology - NHS Fife, Professor **Andy Shennan** - Professor of Obstetrics, and **Dr Annette Briley** – Consultant Midwife, Clinical Trial Manager, Maternal and Fetal Research Unit, Guy's and St Thomas' Hospital, the Desperate Debra® simulator has been designed to facilitate the training and implementation of correct clinical procedures when confronted with impaction of the fetal head - a serious and potentially life threatening event.

Obstetrics has taken the lead in reducing the number of perinatal and neonatal complications by developing emergency drills for major events such as shoulder dystocia and breech delivery using simulators. Until now, however, no simulator has previously been available for training in dealing with an impacted fetal head.

Please read this instruction manual carefully and retain it for future reference.

Skills

- The Desperate Debra® model simulates the abdomen, uterus and fetus of a birthing mother with a mechanism to replicate an impacted fetal head
- Vaginal examination in advanced labour
- Identification of fetal head position with palpable fontanelles, variable degrees of flexion and asynclitism
- Successful delivery of an impacted fetal head at caesarean section with adjustable degrees of difficulty

Features

- Easy to set up, operate and maintain
- Highly realistic vaginal examination and fetal head extraction
- Palpable fontanelles in fetal head
- Variable degrees of difficulty/fetal head impaction
- Adjustable fetal head flexion and asynclitism

Safety and Precautions



The model has been designed for use solely with ultrasound gel. Use of any other lubricant may damage the model and invalidate your guarantee.



Never use the model without first applying lubricant to the fetal head, uterus and birth canal. Do not allow the model to dry out during use, re-apply lubricant as necessary. Non-lubricated use will damage the model.



Note that the model weighs 15 kg, seek assistance when handling the model if necessary.



Always insert the head into the model and adjust the fetal head position with the impaction difficulty adjuster set to easy (green). Do not attempt this on any other setting.



Do not leave or store the model with the fetal head still inside. After use, leave the head extracted and outside of the caesarean opening.



The model must be cleaned regularly to ensure optimal performance.



This simulator has been designed to facilitate training in disimpaction of an impacted fetal head in the pelvis. The procedures demonstrated in this manual serve as a guide only. Local policies will determine the correct way of performing this procedure.



Please treat the simulator with the same care you would a patient.

Contents

Parts	4
- Supplied With	5
Before Use	
- Prepar	7
- Lubricate the Fetal Head and Uterus	7
- Insert the Fetal Head into the Model	
Before Use: Adjust the Fetal Head Position	
- Axial Rotation	9
- Flexion	9
- Asynclitism	11
- Impaction	11
During Use	
- Vaginal Examination	13
- Fetal Head Extraction	13
After Use	
- Cleaning	15
- Storage	15

Parts

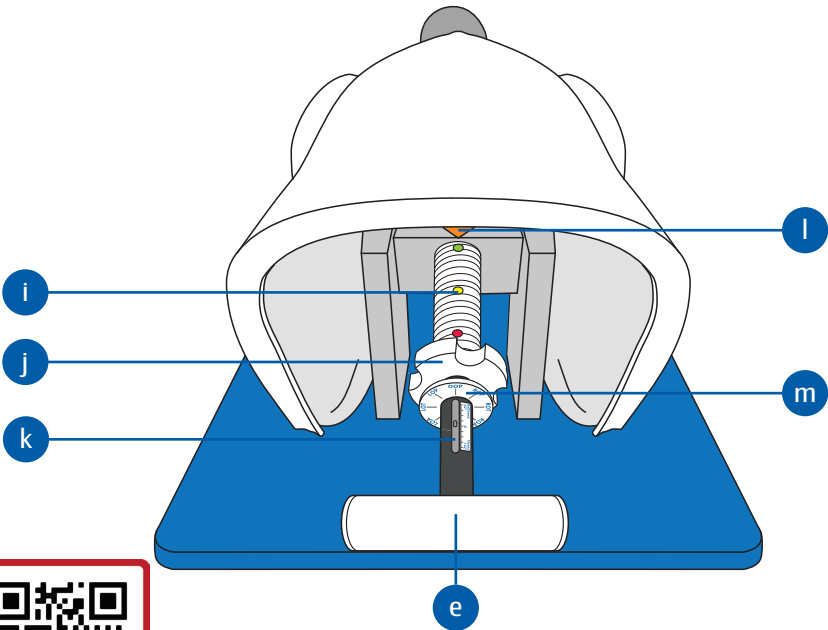
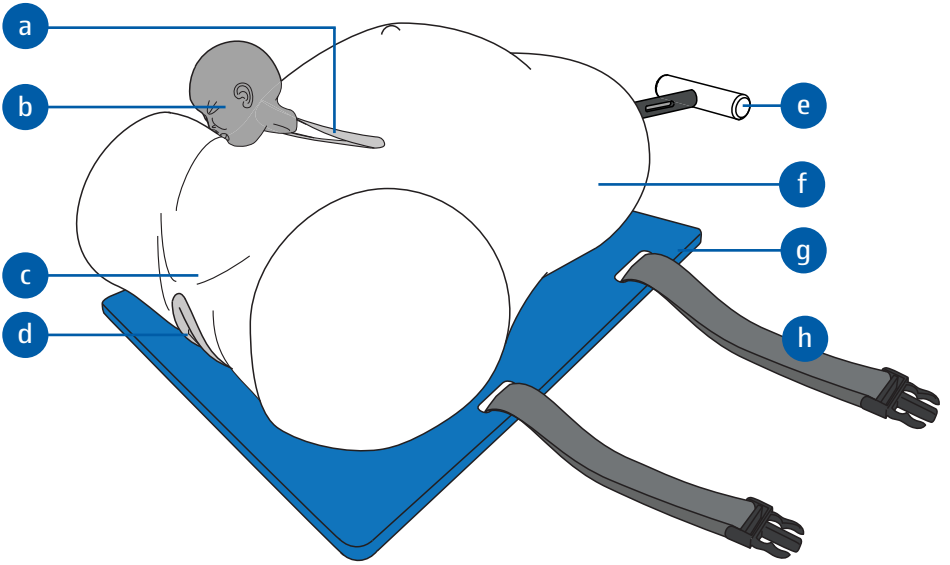

SCAN ME

- a Caesarean incision
- b Fetal head with palpable anterior and posterior fontanelles
- c Internal birthing canal, uterus and pelvis
- d Vaginal opening
- e Fetal head positioning handle
- f Main body
- g Base
- h Adjustable securement straps (x2)
- i Impaction difficulty indicators (red, yellow, green)
- j Impaction difficulty adjustor knob
- k Flexion indicator
- l Axial rotation marker (orange)
- m Axial rotation angle indicator disc

Supplied With

S58/8 LUBRICATING ULTRASOUND GEL (250 ML)



If you require replacement parts please contact our Sales Department, quoting codes where applicable.



Scan the QR code to access the product video.
<https://youtu.be/whifKQkeBfU>

Before Use

1a

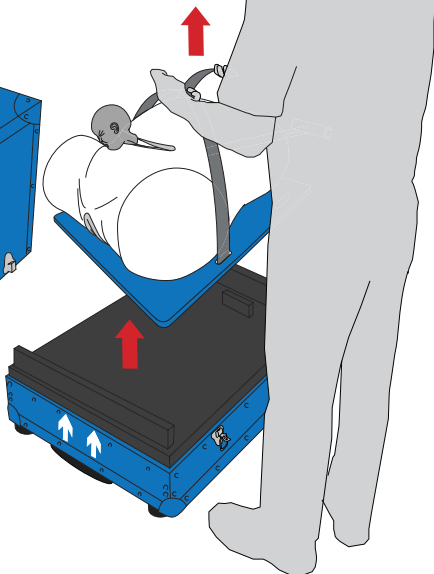
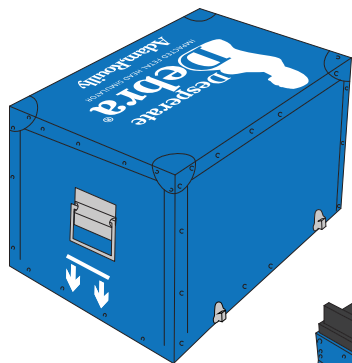

1b

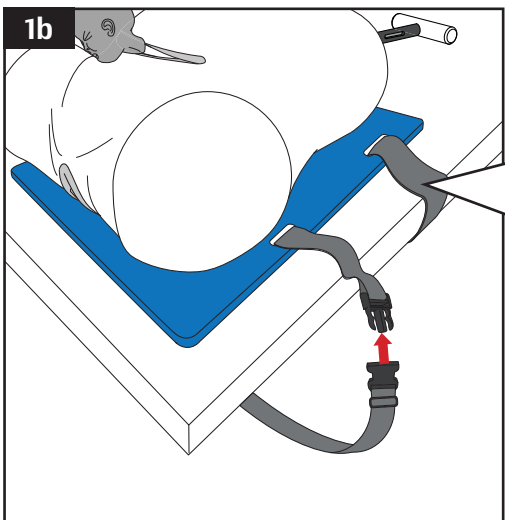

1c

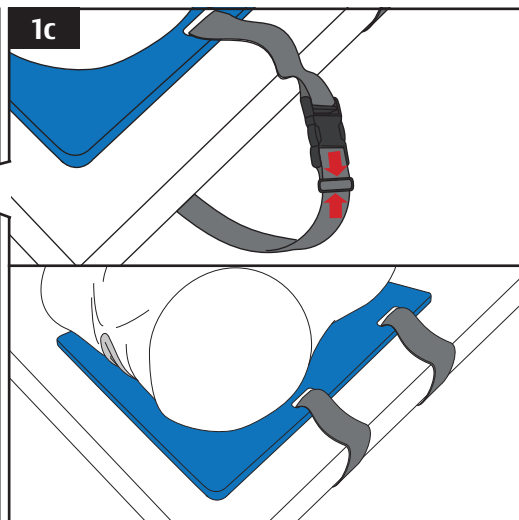

Removing the Model from the Case

1a

Fasten the securement straps over the top of the model and use these to lift the model out of the case, as directed by your Manual Handling Policy.



Note that the model weighs 15 kg, seek assistance when handling the model if necessary.

Secure to a Stable Surface

1b

Ensure the work area is clean and dry.

Keep paper towels nearby in case of any spillage of lubricant.

Position Desperate Debra® on a stable, flat surface and fasten the straps to hold the model securely in place during use.

1c

The straps may be adjusted to lengthen or shorten for table top use.

For best use, shorten the straps after fastening to ensure good securement to the surface.

Before Use

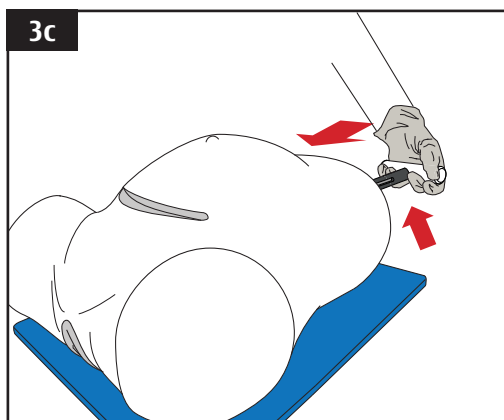
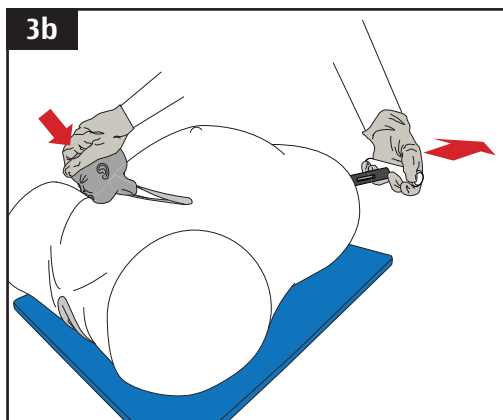
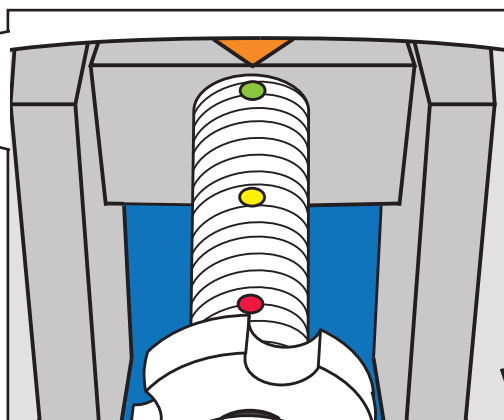
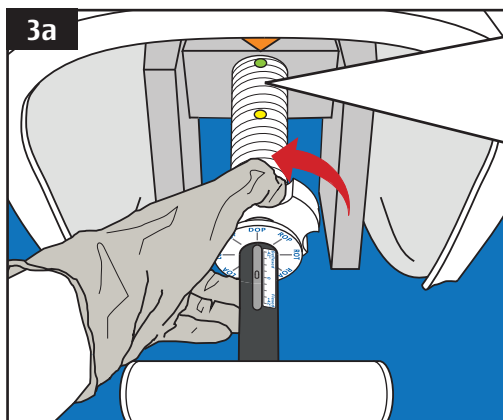
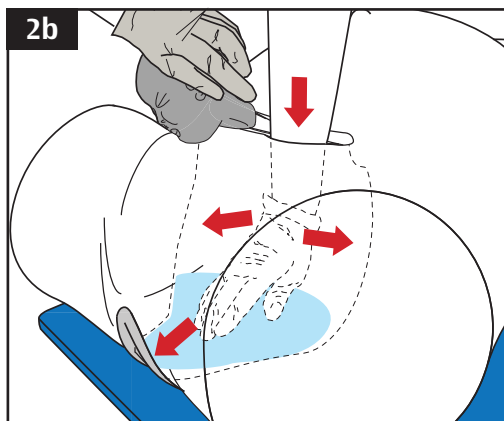
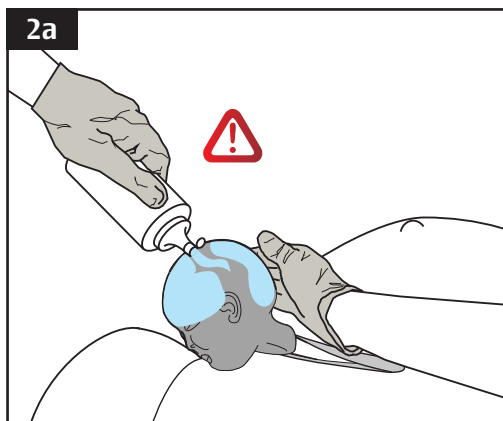

Lubricate the Fetal Head and Uterus

2a

With the fetal head out of the uterus, apply a liberal amount of ultrasound gel to the entire fetal head.

2b

Insert a hand through the caesarean incision and distribute a liberal amount of ultrasound gel throughout the uterus and fully down the birth canal.



The model has been designed for use solely with ultrasound gel. Use of any other lubricant may damage the model and invalidate your guarantee.



Never use the model without first applying lubricant to the fetal head, uterus and birth canal. Do not allow the model to dry out during use, re-apply lubricant as necessary. Non-lubricated use will damage the model.

Insert the Fetal Head into the Model

3a

Decrease the impaction difficulty adjuster to minimum by turning it anti-clockwise until the easy (green) minimum marker shows.



Always insert the head into the model with the impaction difficulty adjuster set to easy (green). Do not attempt this on any other setting.

3b

Using the fetal head positioning handle, carefully draw the fetal head back and down into the model so that it slips into the lubricated uterus, guiding with your hand if required.

3c

Push the fetal head positioning handle forward to guide the fetal head into the lesser pelvis.

Fetal head position and impaction may now be adjusted, see **4a** page 11.

Before Use

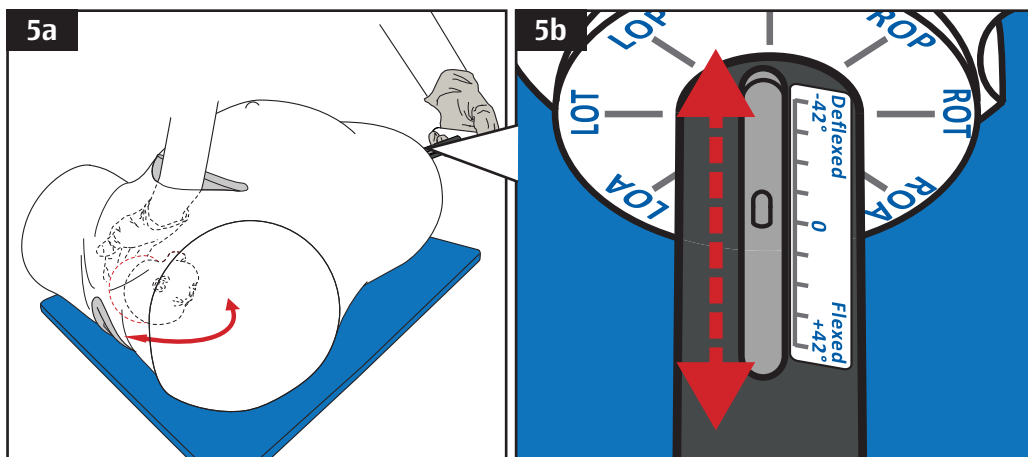
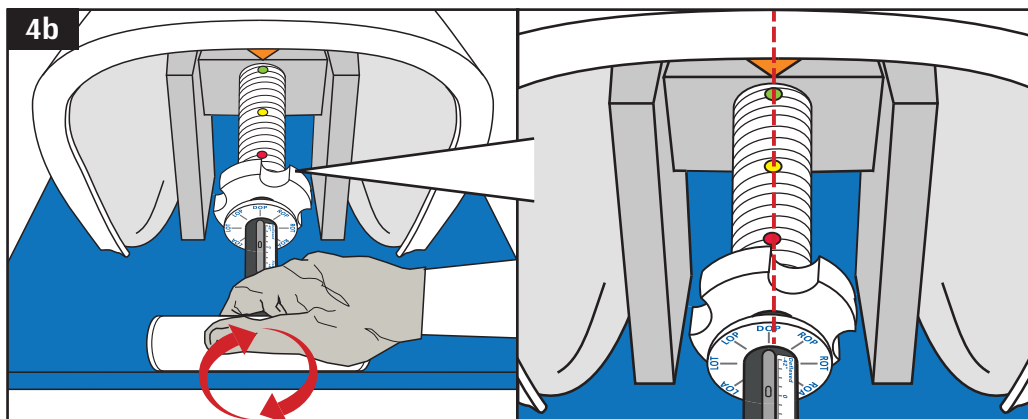
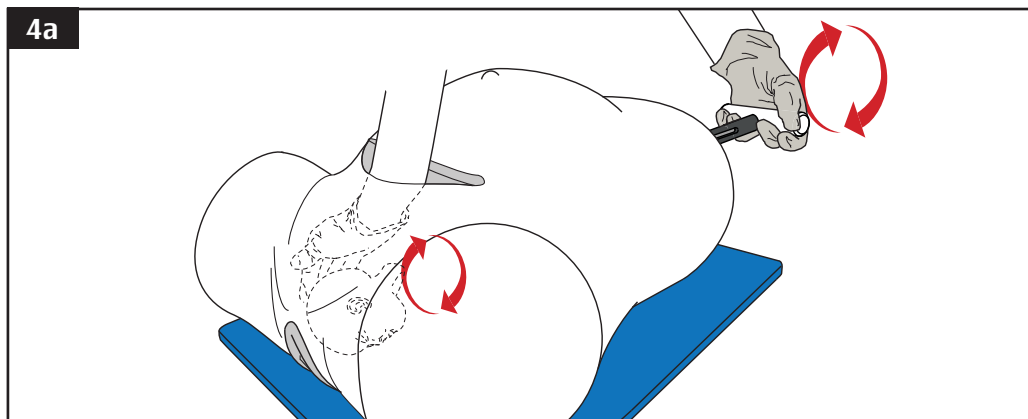

Axial Rotation

4a

Axial rotation of the fetal head may be adjusted using one hand to guide the fetal head inside the uterus while turning the fetal head positioning handle to the desired position.

4b

Align the desired position on the rotation angle indicator with the orange axial rotation marker at the rear of the abdomen.

Axial Rotation Angle Indicator	Fetal Head Position
DOP	Direct Occiput Posterior
ROP	Right Occiput Posterior
ROT	Right Occiput Transverse
ROA	Right Occiput Anterior
DOA	Direct Occiput Anterior
LOA	Left Occiput Anterior
LOT	Left Occiput Transverse
LOP	Left Occiput Posterior



Fetal head indications are true to the positions in real life, i.e. when viewed from the front of the model.



Always adjust the fetal head position with the impaction difficulty adjuster set to easy (green). Do not attempt this on any other setting.

Flexion Position

5a

The flexion angle of the fetal head may be adjusted. Whilst holding the fetal head positioning handle with one hand, steady the fetal head inside the uterus and manually flex or deflex the head. As the head is flexed the vertical pin in the flexion indicator will move.

5b

Whilst flexing the head, align the vertical pin in the flexion indicator with the desired angle of flexion as indicated (- 42° Deflexed, 0 Neutral, +42° Flexed).



Always adjust the fetal head position with the impaction difficulty adjuster set to easy (green). Do not attempt this on any other setting.

Before Use

6a

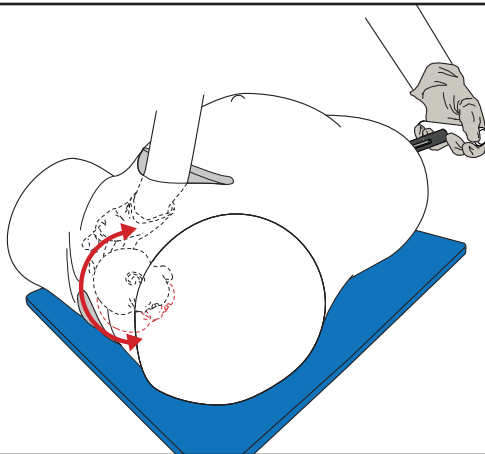

7a

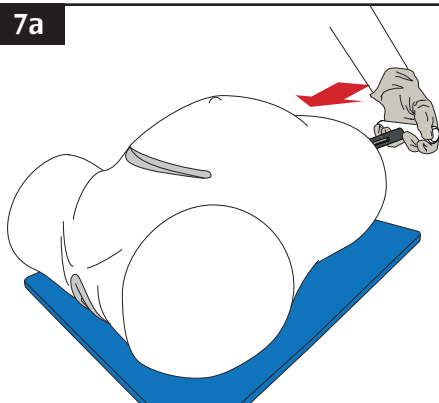

7b

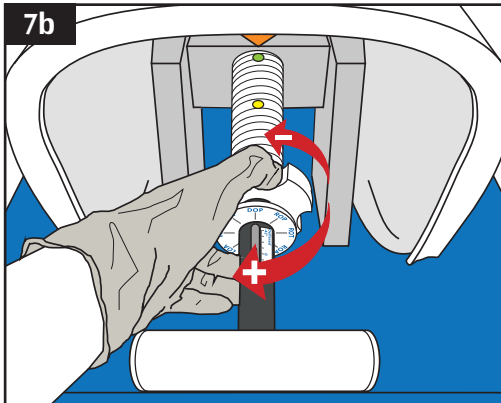

7c

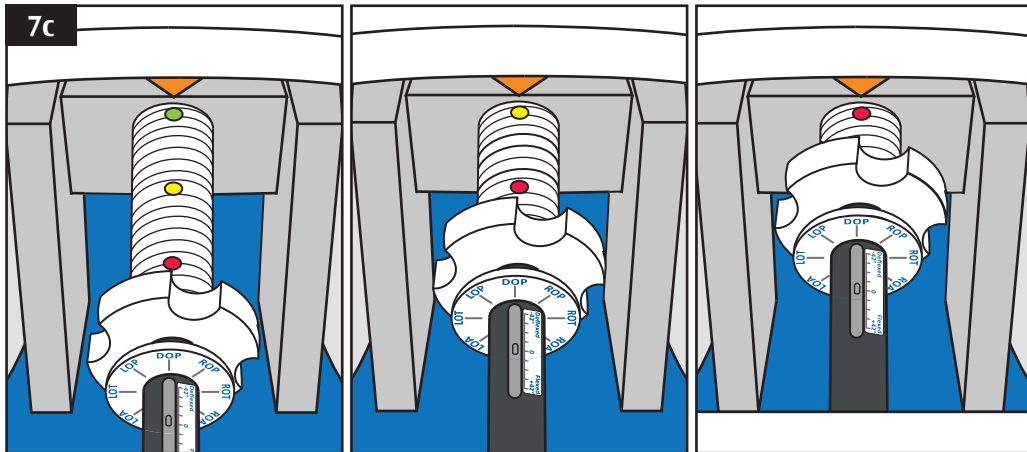

Asynclitism

6a

Asynclitism of the fetal head may be also adjusted. Whilst holding the fetal head positioning handle with one hand, adjust the head on its axis from side to side.



Always adjust the fetal head position with the impaction difficulty adjuster set to easy (green). Do not attempt this on any other setting.

Impaction

7a

With rotation, flexion and asynclitism now set, the amount of impaction of the fetal head in the pelvis may now be adjusted for the degree of difficulty required for extracting the fetal head.

Push the fetal head positioning handle forward to guide the fetal head into the birthing canal if required.

7b

Turn the impaction difficulty adjustor knob clockwise to increase impaction or anti-clockwise to decrease impaction.

7c

Turn the impaction difficulty adjustor knob clockwise to increase impaction or anti-clockwise to decrease impaction.



Easy (green)



Medium (yellow)



Hard (red)

During Use

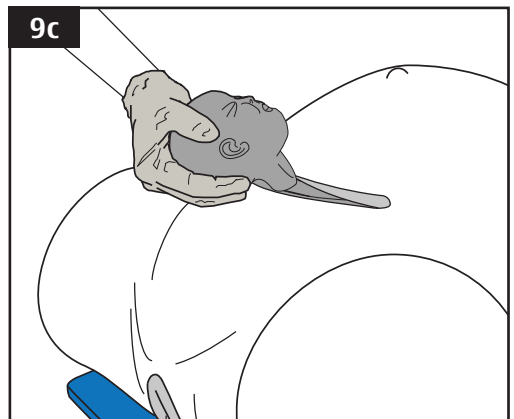
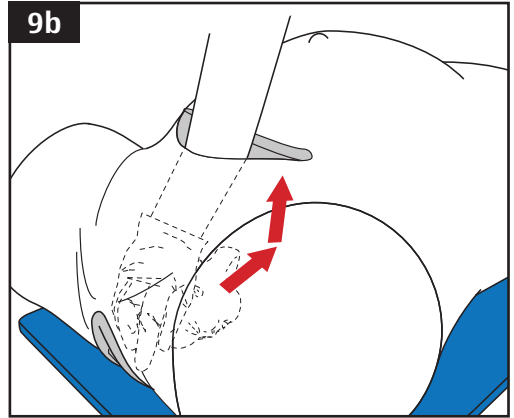
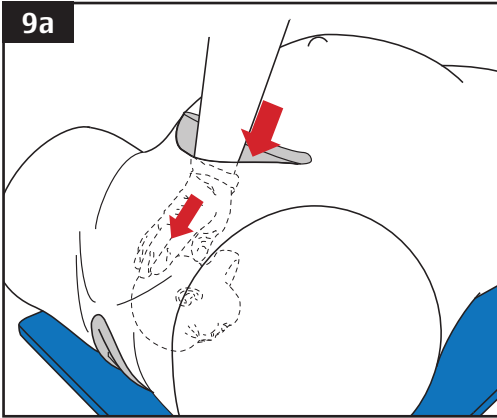
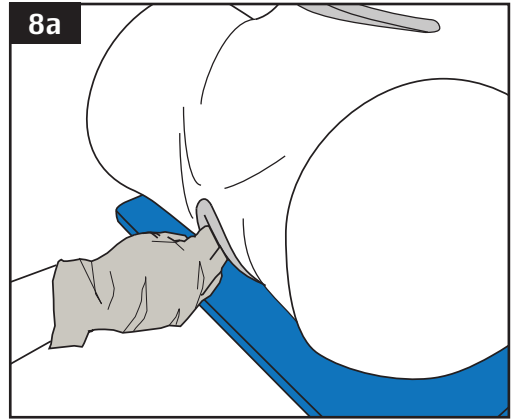

Vaginal Examination

8a

Vaginal examination may be performed on the model to determine the position of the fetal head.



Additional glove lubrication may be required using a small amount of ultrasound gel only.

Fetal Head Extraction



This simulator has been designed to facilitate training in disimpaction of an impacted fetal head in the pelvis. The procedures demonstrated in this manual serve as a guide only. Local policies will determine the correct way of performing this procedure.

9a

To extract the fetal head gently insert a hand into the caesarean incision and slide fingers between the fetal head and uterus.

9b

Firmly grasp the fetal head while pulling backwards and upwards to release the fetal head from the pelvic area.

The level at which the impaction difficulty adjustor knob is set will determine the correct amount of force required to disimpact the head.

9c

Guide the head out of the pelvic area and out through the caesarean incision.

The head has now been delivered successfully. If training is to continue, reset the fetal head as described in **2a** page 9.

If training has finished, see **10a** page 17.

After Use

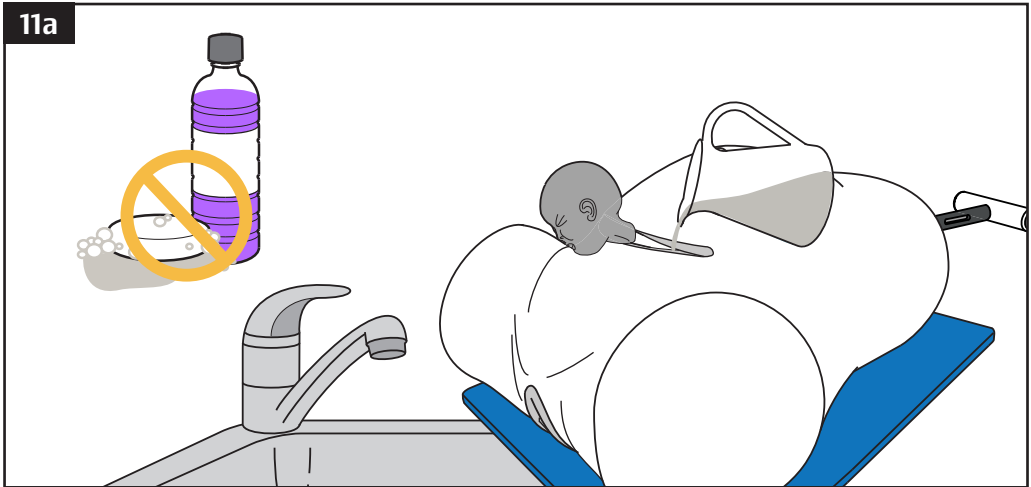
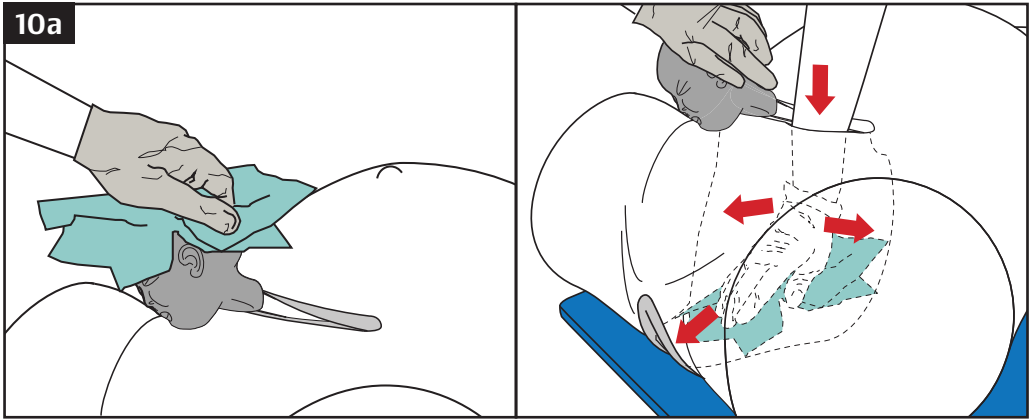

Cleaning

10a

After use, the fetal head must remain extracted and outside of the caesarean opening.

11a

The model may be flushed with warm water to remove remaining ultrasound gel if required.



Do not use soap, detergents or any other chemical cleaners to clean the model.

After Use

12a

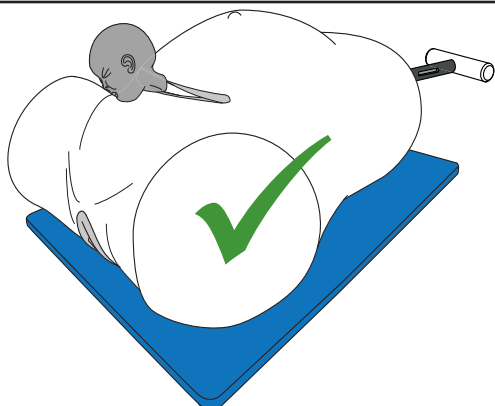
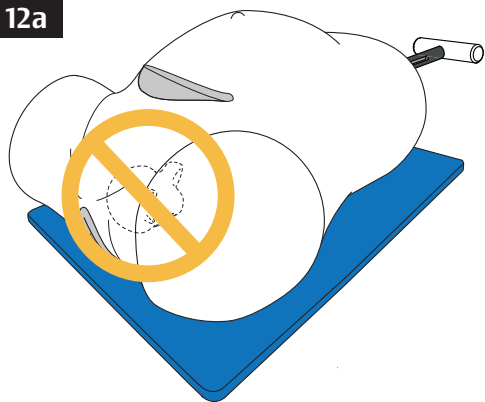

13a

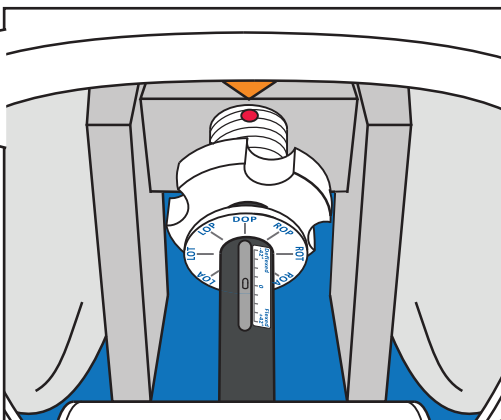
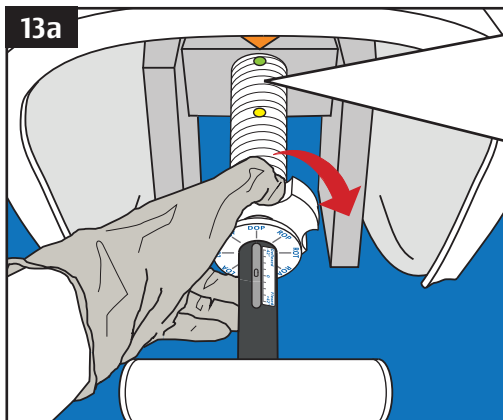

13b

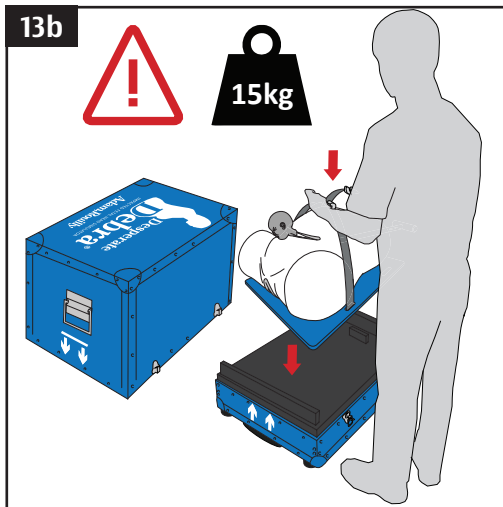

13c

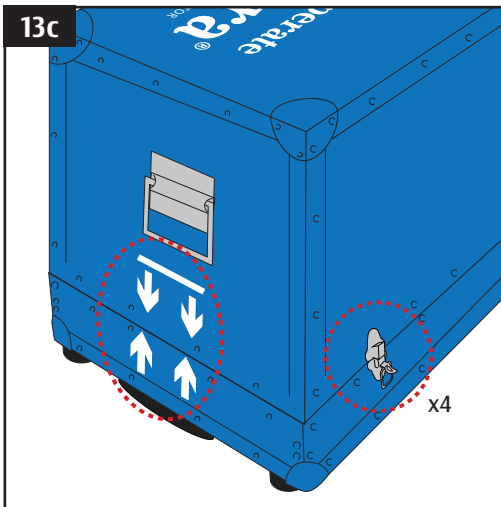

Ensure the Fetal Head is Extracted

12a

After use, the fetal head must remain extracted and outside of the caesarean opening.



Always adjust the fetal head position with the impaction difficulty adjuster set to easy (green). Do not attempt this on any other setting.

Storage in the Included Carrying Case

13a

For the most secure fit in the included carrying case, adjust the impaction difficulty adjuster to Red.

13b

Fasten the securement straps over the top of the model and use these to lift the model onto the base, as directed by your Manual Handling Policy.

Be sure to replace the model back into the case so that the fetal head is facing the white arrows on the base, as shown.



Note that the model weighs 15 kg, seek assistance when handling the model if necessary.

13c

Replace the lid of the case, aligning white arrows on the base with white arrows on the lid. Fasten all four latches.



Ensure all four latches are fastened before moving or carrying the case.

2 Year Guarantee



All products manufactured by Adam,Rouilly are covered by our full 2 Year Guarantee. This guarantee applies to models which have been used correctly and covers durability and functionality.

Adam,Rouilly

As part of our policy of continual product development, the specification of products may alter without prior notice.

Adam,Rouilly has over 100 year's experience in providing quality medical models and simulators.

Should you require any further information please contact our Sales Department who will be pleased to help with your enquiry.

Adam,Rouilly Limited
Castle Road
Eurolink Business Park
Sittingbourne
Kent
United Kingdom
ME10 3AG

T: +44(0)1795 471378
F: +44(0)1795 479787
E: sales@adam-rouilly.co.uk
www.adam-rouilly.co.uk