

BOUNDARY OUTDOOR DETECTOR

BX SHIELD series

WIRED MODEL

BXS-ST : Standard model

BXS-AM : +Anti-masking

1 Introduction

FR Introduction DE Einleitung IT Introduzione ES Introducción PT Introdução NL Inleiding

Full information, with multilanguage, available in ;



<http://navi.optex.net/manual/50155>

- EN** • This "Quick Reference" is the part of the entire installation instructions that guides the installation procedures for installers.
- Get the full information with multi-language of the installation instructions in the web site.
- If you need a guide to the operation of the whole system, please consult your installer of the entire system.
- FR** • Cette "Quick Reference" est la partie des instructions d'installation entières qui guide les procédures d'installation pour les installateurs.
- Obtenez les informations complètes avec multi-langue des instructions d'installation dans le site Web.
- Si vous avez besoin d'un guide pour le fonctionnement du système dans son ensemble, s'il vous plaît consulter votre installateur de l'ensemble du système.
- DE** • Dieses "Quick Reference" ist der Teil der gesamten Installationsanweisungen, die die Installationsverfahren für Installateure führt.
- Holen Sie sich die vollständige Information mit mehrsprachiger der Installationshinweise in der Website.
- Wenn Sie einen Leitfaden für den Betrieb des Systems als Ganzes benötigen, wenden Sie sich bitte an Ihren Installateur des gesamten Systems.

- IT** • Questa "Guida rapida" è la parte di tutto il istruzioni di installazione che guida le procedure di installazione per gli installatori.
- Ottenere le informazioni complete con il multi-linguaggio delle istruzioni di installazione nel sito web.
- Se occorre una guida per il funzionamento del sistema nel suo complesso, consultare l'installatore dell'intero sistema.
- ES** • Este "Referencia rápida" es la parte de la totalidad de las instrucciones de instalación que guía los procedimientos de instalación para los instaladores.
- Obtener la información completa con multi-idioma de las instrucciones de instalación en el sitio web.
- Si necesita una guía para el funcionamiento del sistema en su conjunto, por favor consulte a su instalador de todo el sistema.
- PT** • Este "Referência Rápida" é parte de toda as instruções de instalação que orienta os procedimentos de instalação para os instaladores.
- Obter as informações completas com multi-idioma das instruções de instalação no web site.
- Se você precisa de um guia para a operação do sistema como um todo, por favor consulte o seu instalador de todo o sistema.
- NL** • Deze "Snelle referentie" maakt deel uit van de totale installatieaanwijzingen die de installateur door de installatieprocedures leiden.
- Krijg de volledige meertalige informatie van de installatieaanwijzingen van de website.
- Als u richtlijnen nodig hebt over de werking van het gehele systeem, raadpleeg dan de installateur van het gehele systeem.

2 Manufacturer's statement

FR Déclaration du fabricant DE Herstellererklärung IT Dichiarazione del costruttore ES Declaración del fabricante PT Declaração do fabricante NL Mededeling van de fabrikant

Warning

- FR Avertissement
- DE Warnung
- IT Avvertenza
- ES Aviso
- PT Aviso
- NL Waarschuwing

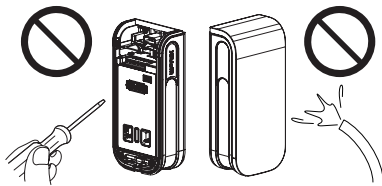

- EN Prohibition
 - FR Interdiction
 - DE Verbot
 - IT Divieto
 - ES Prohibición
 - PT Proibição
 - NL Verbot
- Recommendation
 - Recommandation
 - Empfehlung
 - Raccomandazione
 - Recomendación
 - Recomendação
 - Aanbeveling

Caution

- FR Attention
- DE Vorsicht
- IT Attenzione
- ES Precaución
- PT Cuidado
- NL Voorzichtig

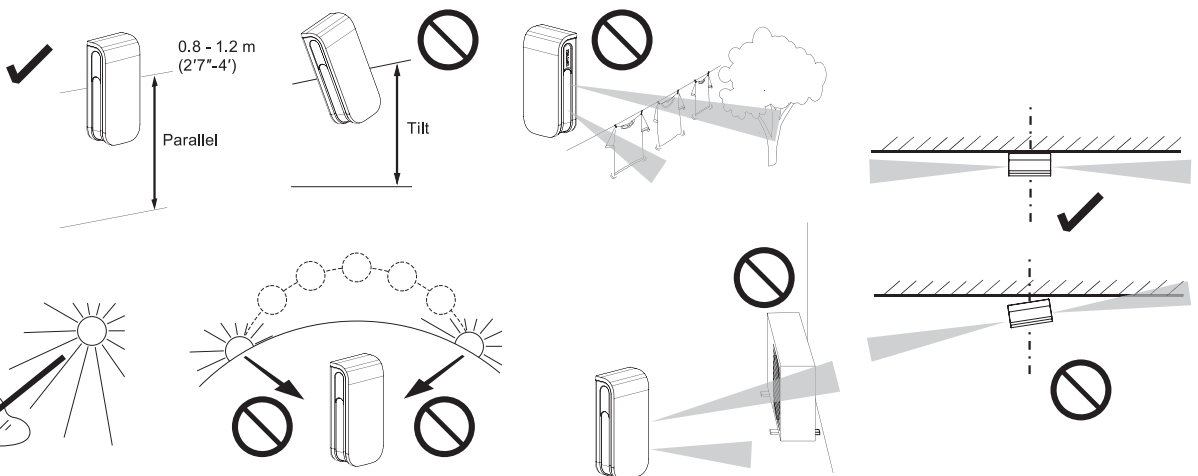

3-1. Parts identifications

FR Identification des pièces DE Teile-identifikation IT Descrizione delle parti
ES Identificación de los partes PT Identificação de peças NL Identificatie onderdelen

Face cover

FR Couverture de visage
DE Gesichts-Abdeckung
IT Copertura del fronte
ES Cubierta de la cara
PT Cobrir o rosto
NL Gezicht te bedekken

Wiring sponge

FR Eponge de câblage
DE Drahtisolierung
IT Spugnetta di protezione cavo
ES Esponja de cableado
PT Esponja de fiação
NL Bedradingspons

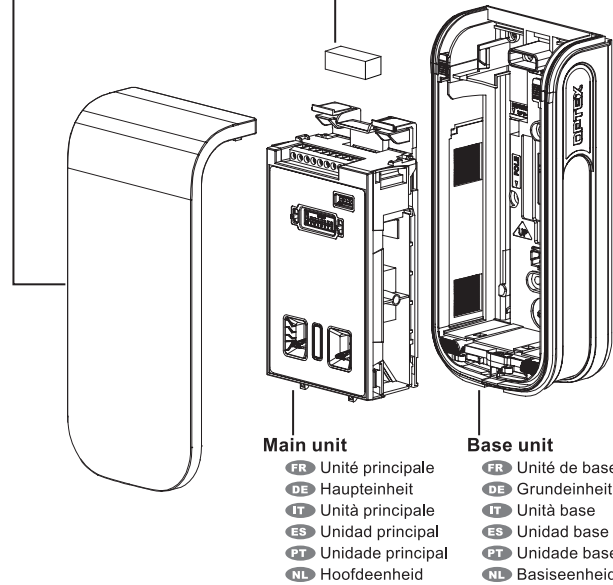

Main unit

FR Unité principale
DE Haupteinheit
IT Unità principale
ES Unidad principal
PT Unidade principal
NL Hoofdeenheid

Base unit

FR Unité de base
DE Grundeinheit
IT Unità base
ES Unidad base
PT Unidade base
NL Basiseenheid

<Accessories>

FR Accessoires DE Zubehör IT Accessori ES Accesorios PT Acessórios
NL Accessoires

For wall mounting
Screw (4 x 20 mm)

Screw kit

FR Jeu de vis
DE Schraubensatz
IT Set di viti
ES Tornillería
PT Kit de parafusos
NL Schroevenset

<Options>

FR Options DE Optionen IT Opzioni ES Opciones PT Opções NL Opties

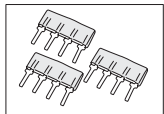

Plug-in EOL [PEU]

FR Brancher sur EOL
DE EOL-stecker
IT Fine linea (EOL) a innesto
ES Plug-in EOL
PT Plug-in EOL
NL Insteek-EVL



Back box (Black / White) [BXS Back box] *

* Cap (White) [BXS Cap] is installed in factory default.

FR Arrière du boîtier
DE Rückkasten
IT Scatola posteriore
ES Caja trasera
PT Caixa traseira
NL Achterkant van de kast



Pole mount plate

FR Plaque de montage sur poteau
DE Pfosten Montageplatte
IT Base di montaggio su palo
ES Soporte de montaje en poste
PT Placa de montagem no poste
NL Paal montageplaat



Cap (White / Silver / Black) [BXS Cap]

FR Casquette (Blanc / Argent / Noir)
DE Kappe (Weiß / Silber / Schwarz)
IT Berretto (Bianca / Argento / Nero)
ES Gorra (Blanco / Plata / Negro)
PT Boné (Branco / Prata / Preto)
NL Dop (wit / zilver / zwart)

Face cover (White / Silver / Black) [BXS Face cover]

FR Couverture de visage (Blanc / Argent / Noir)
DE Gesichts-Abdeckung (Weiß / Silber / Schwarz)
IT Copertura del fronte (Bianca / Argento / Nero)
ES Cubierta de la cara (Blanco / Plata / Negro)
PT Cobrir o rosto (Branco / Prata / Preto)
NL Gezicht te bedekken (wit / zilver / zwart)

3-2. Before mounting

FR Avant l'ontage DE Vor der montage IT Prima del montaggio
ES Antes de la montaje PT Antes da montagem NL Voor de montage

1

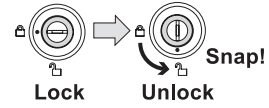
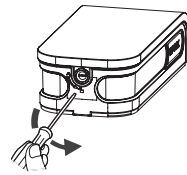

- Excessive turn

FR Tour excessive
DE Übermäßige Wende
IT Svolta eccessiva
ES Girando excesiva
PT Viragem excessiva
NL Overmatig verdraaien



- Reverse rotation

FR Rotation inverse
DE Rückwärtsdrehung
IT Rotazione inversa
ES Rotación inversa
PT Rotação reversa
NL Omgekeerde rotatie

2



3

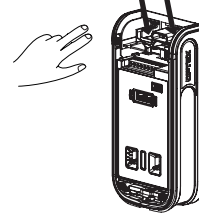

4

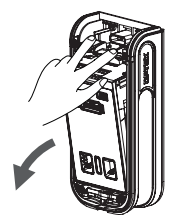

3-3. Mounting

FR Montage DE Montage IT Montaggio ES Montaje PT Montagem
NL Bevestiging

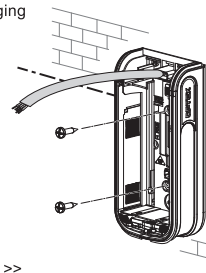

Wall mount

FR Montage mural
DE Wandmontage
IT Montaje a parete
ES Montagem en pared
PT Montagem na parede
NL Wandmontage

Mounting height
0,8 - 1,2 m
(1.0 m is recommended)

<< With option parts >>

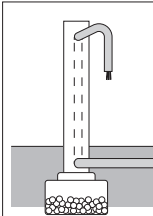

Pole mount

< With option pole mount plate >

FR Montage sur poteau
DE Pfostenmontage
IT Montaggio su palo
ES Montaje en poste
PT Montagem no poste
NL Paalmontage

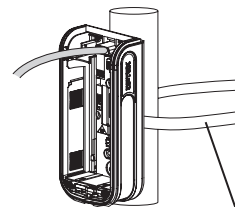

Metal band ≤ 23 mm (1 inch) in width

FR Ruban métallique ≤ 23 mm (1 pouce) de largeur
DE Metal-Band ≤ 23mm (1 Zoll) in der Breite
IT Metal band ≤ 23 mm (1 pollice) di larghezza
ES Banda de metal ≤ 23 mm (1 pulgada) de ancho
PT Banda de metal ≤ 23 mm (1 polegada) de largura
NL Metalen band ≤ 23 mm (1 inch) breed

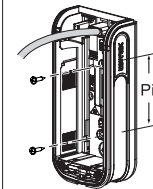

Electric gang box mount

FR Montage boîte de gang électrique
DE Elektrische Gerätedose montieren
IT Montaggio scatola di giunzione elettrica
ES Montaje en caja eléctrica eléctrica
PT Montar a caixa de gangues elétrica
NL Bevestiging elektrische groepenkast

Pitch 83.5 mm (3.29 inch)

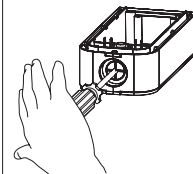

Conduit installation

< With option back box >

FR Installation conduit
DE Conduit-Installation
IT Installazione Conduit
ES Instalación de conectores
PT Instalação do condute
NL Installatie van de kabelgoten

3-4. Assembling

FR Assemblage DE Zusammenstellung IT Assemblaggio ES Asamblea
PT Assembléia NL Assemblage

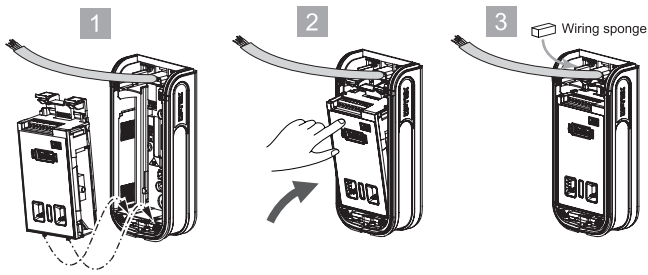

3-5. Wiring

FR Câblage DE Verkabelung IT Collegamenti ES Cableado PT Fiação
NL Bedrading

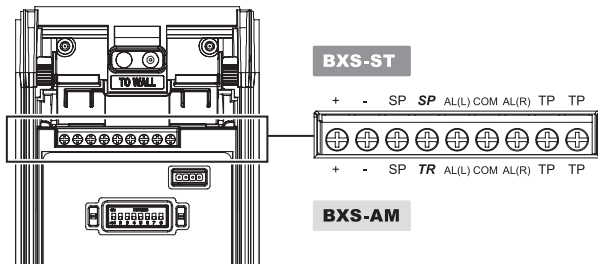

(+)	(-)	SP	TR	AL(L) *	COM	AL(R) *	TP
Power		Spare	Trouble	Alarm(L)	Common	Alarm(R)	Tamper

(+)	(-)	SP	TR	AL(L) *	COM	AL(R) *	TP
Alimentation	En réserve	Problème	Alarme (L)	Commun	Alarme (R)	Auto -protection	

(+)	(-)	SP	TR	AL(L) *	COM	AL(R) *	TP
Strom -einspeisung	Reserve	Störung	Alarm (L)	Gewöhnlich	Alarm (R)	Sabotage -ausgang	

(+)	(-)	SP	TR	AL(L) *	COM	AL(R) *	TP
Alimentazione	Libero	Guasto	Allarme (L)	Comune	Allarme (R)	Antimano -missione	

(+)	(-)	SP	TR	AL(L) *	COM	AL(R) *	TP
Alimentación	Libres (No user)	Problema	Alarma (L)	Común	Alarma (R)	Antisabotaje	

(+)	(-)	SP	TR	AL(L) *	COM	AL(R) *	TP
Alimentação	Sobress -alente	Problema	Alarme (L)	Comum	Alarme (R)	Sabotagem	

(+)	(-)	SP	TR	AL(L) *	COM	AL(R) *	TP
Stroomvoor -ziening	Ruimte	Problemen	Alarm (L)	Gemeens -chappelijk	Alarm (R)	Sabotage	

* Alarm(L) and (R) can be assigned to "General Alarm" by turning OFF of DIP switch No.3.

< Power cable length > Unit : m (ft.)

FR Longueur du câble d'alimentation Unité : m (pieds)
DE Stromkabellänge Einheit : m (FüÙe)
IT Lunghezza del cavo di alimentazione Unità : m (piedi)
ES Longitud del cable de alimentación Unidad : m (pies)
PT Comprimento do cabo de alimentação Unidade : m (pés.)
NL Lengte netsnoer Eenheid : m (voet)

WIRE GAUGE	BXS-ST Current draw 31 mA		BXS-AM Current draw 34 mA	
	12V	14V	12V	14V
AWG 22 (0.33 mm ²)	190 (620)	400 (1 310)	170 (560)	370 (1 210)
AWG 20 (0.52 mm ²)	290 (950)	630 (2 070)	270 (890)	580 (1 900)
AWG 18 (0.83 mm ²)	470 (1 540)	1 010 (3 310)	430 (1 410)	920 (3 020)

<< With option parts >>

3-6. EOL options

FR EOL options DE EOL options IT EOL opzioni ES EOL opción
PT EOL opções NL EVL-opties

< Using Plug-in EOL (PEU) >

FR Utilisation Branchez EOL (PEU) DE Mit Plug-in EOL (PEU)
IT Utilizzo di Plug-in EOL (PEU) ES Mediante Plug-in EOL (PEU)
PT Usando Ligue EOL (PEU) NL Met gebruik insteek-EVL (PEU)

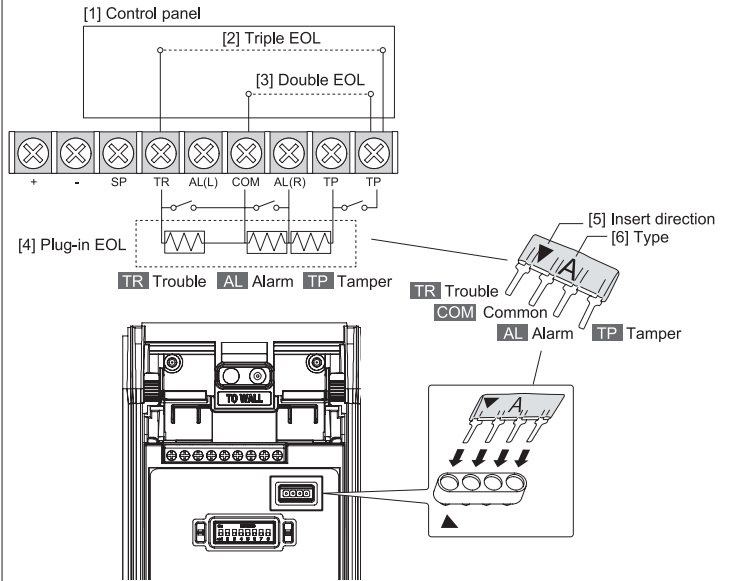

FR	DE	IT
[1] Panneau de contrôle	[1] Steuerpult	[1] Pannello di controllo
[2] Triple EOL	[2] Triple EOL	[2] Triple EOL
[3] Double EOL	[3] Doppel EOL	[3] Doppia EOL
[4] Branchez EOL	[4] Plug-in EOL	[4] Plug-in EOL
[5] Insérer direction	[5] Insert Richtungrt	[5] Inserire la direzione
[6] Type	[6] Art	[6] Tipo
TR Problème	TR Störung	TR Guasto
AL Alarme	AL Alarme	AL Allarmi
TP Autoprotection	TP Sabotageausgang	TP Antimanomissione
COM Commun	COM Gewöhnlich	COM Comune

ES	PT	NL
[1] Panel de control	[1] Painel de controle	[1] Bedieningspaneel
[2] EOL triple	[2] EOL triplo	[2] Drievoudige EVL
[3] EOL doble	[3] EOL duplo	[3] Dubbele EVL
[4] Plug-in EOL	[4] Ligue EOL	[4] Insteek-EVL
[5] Dirección de inserción	[5] Inserir direção	[5] Richting voor insteken
[6] Tipo	[6] Tipo	[6] Type
TR Problema	TR Problema	TR Problemen
AL Alarma	AL Alarme	AL Alarm
TP Antisabotaje	TP Sabotagem	TP Sabotage
COM Común	COM Comum	COM Gemeenschappelijk

< Without Plug-in EOL (PEU) >

FR Sans Branchez EOL (PEU) DE Ohne Plug-in EOL (PEU)
IT Senza EOL Plug-in (PEU) ES Sin Plug-in EOL (PEU)
PT Sem Ligue EOL (PEU) NL Zonder insteek-EVL

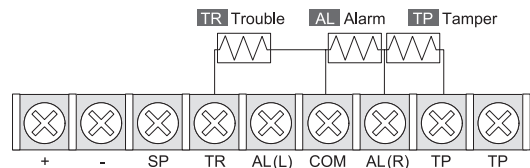

4-1. PIR detection area

- FR** PIR zone de detection **DE** PIR Erfassungsbereich **IT** PIR area di rilevamento
- ES** PIR área de detección **PT** PIR área de detecção **NL** Detectiegebied PIR

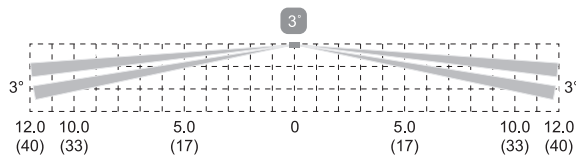
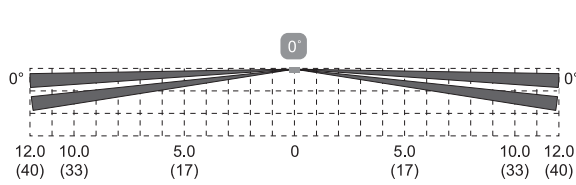
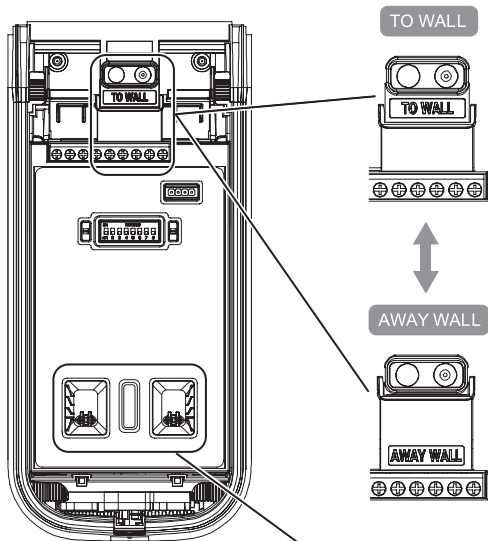

Top view

- FR** Vue de dessus
- DE** Draufsicht
- IT** Vista dall'alto
- ES** Vista superior
- PT** Vista de cima
- NL** Bovenanzicht

Unit: m (ft.)

- FR** Unité: m (pieds)
- DE** Einheit: m (FüÙe)
- IT** Unità: m (piedi)
- ES** Unidad: m (pies)
- PT** Unidade: m (pés)
- NL** Eenheid: m (voet)

Side view

- FR** Vue de coté
- DE** Seitenansicht
- IT** Vista laterale
- ES** Vista lateral
- PT** Vista lateral
- NL** Zijaanzicht

Unit: m (ft.)

- FR** Unité: m (pieds)
- DE** Einheit: m (FüÙe)
- IT** Unità: m (piedi)
- ES** Unidad: m (pies)
- PT** Unidade: m (pés)
- NL** Eenheid: m (voet)

Left side

Right side

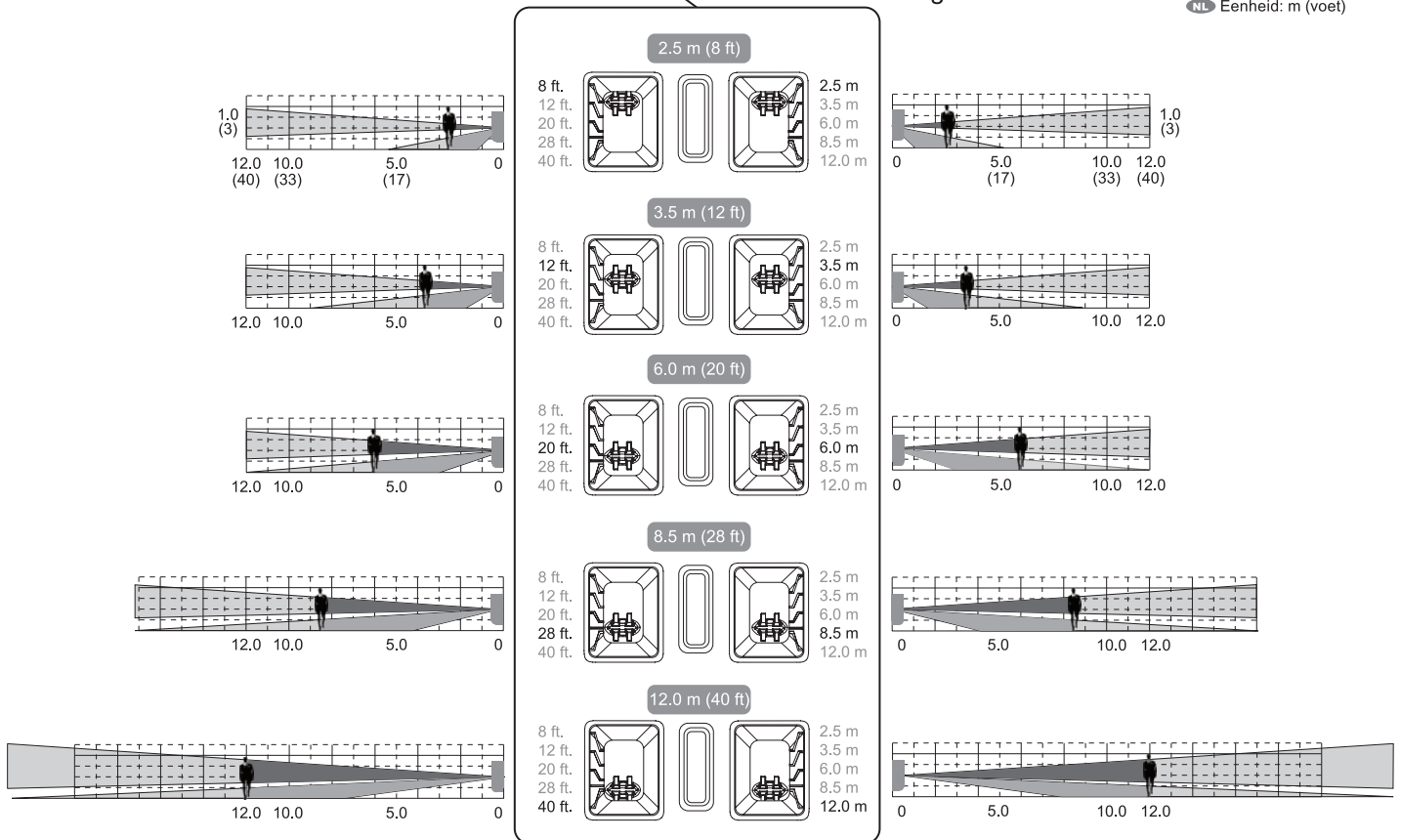

4-2. Switch setting

FR Réglages des interrupteur
IT Impostazioni degli interruttori
PT Ajuste da chave

DE Schallereinstellungen
ES Ajuste del conmutador
NL Instellingen switches

EN

BXS-ST	1	2	3	4	5	6	7	8
BXS-AM	1	2	3	4	5	6	7	8
Item	LED	Alarm output type	* Individual outputs	** PIR Extreme High		Future use	Anti-masking	Future use
				Left	Right			
ON	ON	N.O.	ON	ON	ON	N/A	ON	N/A
OFF	OFF	N.C.	OFF	OFF	OFF		OFF	

FR

BXS-ST	1	2	3	4	5	6	7	8
BXS-AM	1	2	3	4	5	6	7	8
Article	LED	Type de sortie d'alarme	* Sorties individuelles	** PIR Extrême Haute		Usage futur	Anti-masquage	Usage futur
				Gauche	Droite			
ON	ON	N.O.	ON	ON	ON	N/A	ON	N/A
OFF	OFF	N.C.	OFF	OFF	OFF		OFF	

IT

BXS-ST	1	2	3	4	5	6	7	8
BXS-AM	1	2	3	4	5	6	7	8
Articolo	LED	Tipo di uscita di allarme	* Uscite individuali	** PIR Estrema Alta		Utilizzo futuro	Antimascaramento	Utilizzo futuro
				Sinistra	Destra			
ON	ON	N.A. [norm. aperto]	ON	ON	ON	N/A	ON	N/A
OFF	OFF	N.C. [norm. chiuso]	OFF	OFF	OFF		OFF	

PT

BXS-ST	1	2	3	4	5	6	7	8
BXS-AM	1	2	3	4	5	6	7	8
Item	LED	Tipo de saída de alarme	* Saídas individuais	** PIR Extrema Alto		Uso futuro	Antimascaramento	Uso futuro
				Esquerda	Direito			
ON	ON	N.A. [norm. aberto]	ON	ON	ON	N/A	ON	N/A
OFF	OFF	N.F. [norm. fechado]	OFF	OFF	OFF		OFF	

DE

BXS-ST	1	2	3	4	5	6	7	8
BXS-AM	1	2	3	4	5	6	7	8
Artikel	LED	Alarm ausgabe typ	* Einzelne Ausgänge	** PIR Extrem Hoch		Zukünftiger Gebrauch	Anti-masking	Zukünftiger Gebrauch
				Links	Recht			
ON	ON	N.O.	ON	ON	ON	N/A	ON	N/A
OFF	OFF	N.C.	OFF	OFF	OFF		OFF	

ES

BXS-ST	1	2	3	4	5	6	7	8
BXS-AM	1	2	3	4	5	6	7	8
Ítem	LED	Tipo de salida de alarma	* Salidas individuales	** PIR Extrema Alto		Uso futuro	Antimascaramiento	Uso futuro
				Izquierda	Derecha			
ON	ON	N.O.	ON	ON	ON	N/A	ON	N/A
OFF	OFF	N.C.	OFF	OFF	OFF		OFF	

NL

BXS-ST	1	2	3	4	5	6	7	8
BXS-AM	1	2	3	4	5	6	7	8
Item	LED	Alarm-uitvoertype	* Individuele uitgangen	** PIR Extrem Hoog		Toekomstig gebruik	Anti maskering	Toekomstig gebruik
				Links	Rechts			
ON	ON	N.O.	ON	ON	ON	N/A	ON	N/A
OFF	OFF	N.C.	OFF	OFF	OFF		OFF	

*Alarm outputs ; Individual outputs ON/OFF by DIP SW No.3

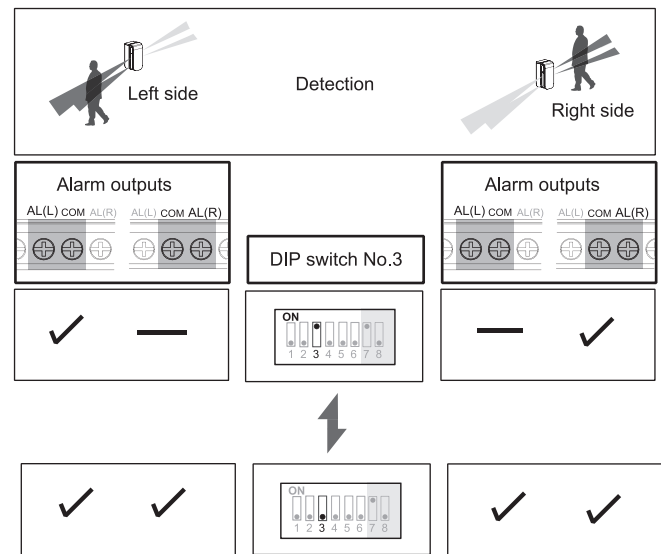

** PIR Extreme High ; ON/OFF by DIP SW No.4 & 5

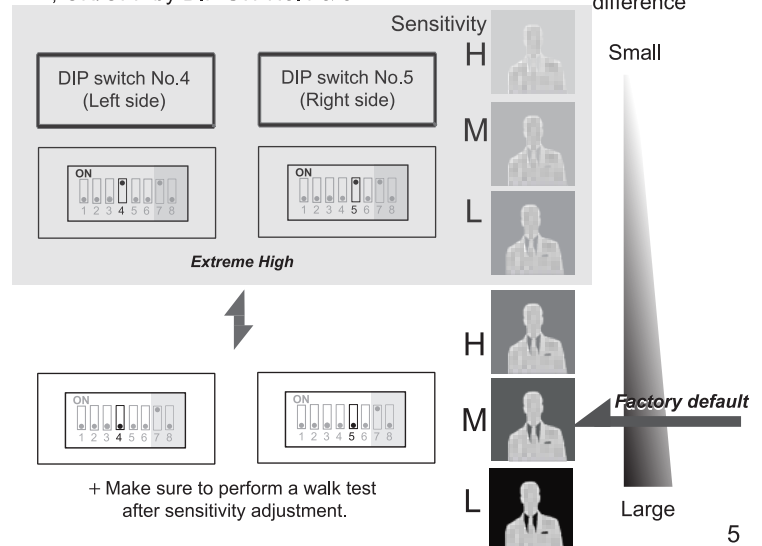

+ Make sure to perform a walk test after sensitivity adjustment.

Factory default

FR Défaut
DE Werkseinstellung
IT Predefinita
ES Defecto
PT Configuração de fábrica
NL Fabrieksinstellingen

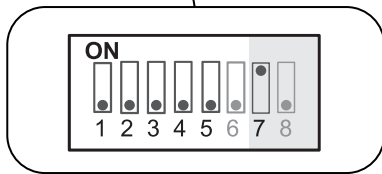

4-3. PIR sensitivity

FR Sensibilité PIR
IT Sensibilità PIR
PT Sensibilidade do PIR
DE PIR-Empfindlichkeit
ES Sensibilidad PIR
NL PIR gevoeligheid

EN

A	High
B	Middle (Default)
C	Low

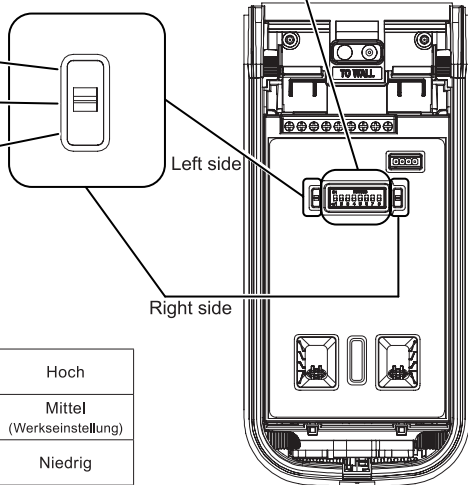

FR

A	Haute
B	Moyen (Défaut)
C	Faible

DE

A	Hoch
B	Mittel (Werkseinstellung)
C	Niedrig

IT

A	Alta
B	Media (Predefinita)
C	Bassa

ES

A	Alta
B	Media (Defecto)
C	Baja

PT

A	Alta
B	Média (Configuração)
C	Baixa

NL

A	Hoog
B	Middelmatig (Fabrieksinstellingen)
C	Laag

5 Checking

FR Vérification DE Überprüfung IT Verifica ES Comprobación PT Checagem NL Controleren

5-1. Walk test

FR Test de marche DE Gehtest IT Prova di movimento
ES Prueba de funcionamiento PT Test de caminhada NL Looptest

1 Close the face cover, "WALK TEST" starts automatically.

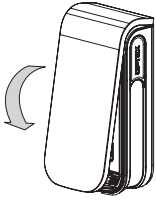

FR Fermez la couverture du visage, "Test de marche" démarre automatiquement.
DE Schließen Sie die Gesichts-Abdeckung, "Gehtest" startet automatisch.
IT Chiudere la copertura del fronte, "Prova di movimento" avvia automaticamente.
ES Cierre la cubierta de la cara, "Prueba de funcionamiento" se inicia automáticamente.
PT Feche a cobrir o rosto, "Test de caminhada" inicia-se automaticamente.
NL Sluit het gezicht te bedekken, de "Looptest" start automatisch

2 Check that LED lights for 2 seconds when the intended object is detected.

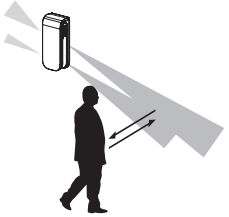

FR Vérifier que les lumières LED pour 2 secondes lorsque l'objet visé est détecté.
DE Prüfen Sie, ob LED-Leuchten für 2 Sekunden, wenn das beabsichtigte Objekt erkannt wird.
IT Controllare che le luci LED per 2 secondi quando viene rilevato l'oggetto desiderato.
ES Comprobar que las luces LED de 2 segundos cuando se detecta el objeto pretendido.
PT Verifique se as luzes LED para 2 segundos quando o objeto pretendido for detectado.
NL Controleer dat de LED-lampjes gedurende 2 seconden oplichten wanneer het bedoeld voorwerp wordt waargenomen

3 "WALK TEST" expires 3 minutes after closing the face cover, with LED blinks for 5 seconds.

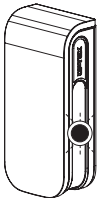

FR "Test de marche" expire 3 minutes après la fermeture la couverture du visage, avec LED clignote pendant 5 secondes.
DE "Gehtest" gültig bis 3 Minuten nach die Gesichts-Abdeckung zu schließen, mit LED für 5 Sekunden blinkt.
IT "Prova di movimento" scade 3 minuti dopo aver chiuso la copertura del fronte, con LED lampeggia per 5 secondi.
ES "Prueba de funcionamiento" expira 3 minutos después de cerrar la cubierta de la cara, con el LED parpadea durante 5 segundos.
PT "Test de caminhada" expira 3 minutos depois de fechar a cobrir o rosto, com LED pisca durante 5 segundos.
NL De "Looptest" verstrijkt 3 minuten na het sluiten van het gezicht te bedekken, waarbij de LED gedurende 5 seconden knippert.

5-2. LED indication

FR LED d'indication DE LED-Anzeige IT Indicazioni LED
ES Indicación del LED PT Indicação do LED NL LED-indicator

BXS-ST

BXS-AM

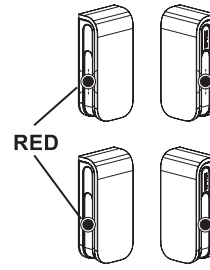

Warm-up ; Blinks for 60 sec. or less.

FR Rouge; **Chauffe**; Clignote pendant 60 sec. ou moins.
DE Rot; **Aufwärmen**; Blinkt für 60 Sekunden. oder weniger.
IT Rosso; **Riscaldamento**; Lampeggia per 60 sec. o meno.
ES Rojo; **Calentamiento**; Parpadea durante 60 sec. o menos.
PT Vermelho; **Aquecimento**; Pisca por 60 s ou menos.
NL Rood; **opwarmen**; knippert gedurende 60 sec. of minder.

Alarm ; Lights for 2 sec.

FR Rouge; **Alarme**; S'allume pendant 2 sec.
DE Rot; **Alarm**; Leuchtet für 2 Sekunden.
IT Rosso; **Allarme**; Si accende per circa 2 sec.
ES Rojo; **Alarma**; Se enciende fijo durante 2 sec.
PT Vermelho; **Alarme**; Acende por 2 sec.
NL Rood; **alarm**; licht gedurende 2 sec. op

BXS-ST

BXS-AM

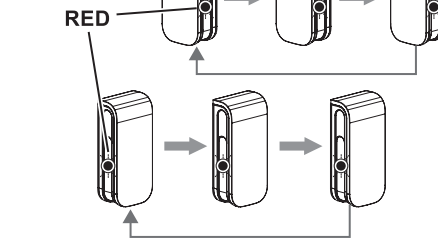

Masking detection ; Blinks 3 times & repeats.

FR Rouge; **Détection de masquage**; Clignote 3 fois, puis se répète.
DE Rot; **Maskierungswahrnehmung**; Blinkt wiederholend dreimal.
IT Rosso; **Mascheramento**; Lampeggia 3 volte e quindi ripete il ciclo.
ES Rojo; **Mascaramento**; Parpadea 3 veces y después de repite.
PT Vermelho; **Mascaramento**; Pisca 3 vezes e repete.
NL Rood; **maskeringsdetectie**; knippert 3 keer en herhaalt dit

6 Detection area

FR Zone de détection DE Erfassungsbereich IT Area di rilevazione
ES Área de detección PT Área de deteção NL Detectiebereik

Top view

FR Vue de dessus
DE Draufsicht
IT Vista dall'alto
ES Vista superior
PT Vista de cima
NL Bovenanzicht

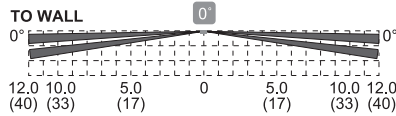

Unit: m (ft.)

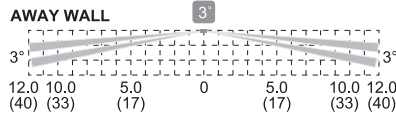

Side view

FR Vue de côté
DE Seitenansicht
IT Vista laterale
ES Vista lateral
PT Vista lateral
NL Zijaanzicht

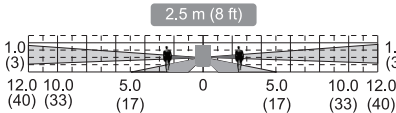

Unit: m (ft.)

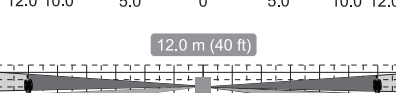
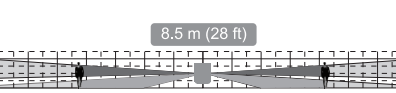
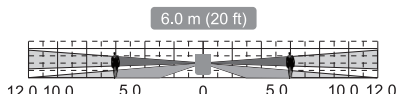
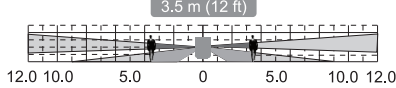

7 Specifications

FR Spécifications DE Spezifikationen IT Specificazioni
ES Especificaciones PT Especificações NL Specificaties

EN

Model	BXS-ST	BXS-AM
Detection method	Passive infrared	
PIR Coverage	24 m (80') ; 12 m (40') on each side, 4 zones ; 2 zones on each side, 180°narrow	
PIR distance limit	2.5 to 12 m (5 levels)	
Detection angle from wall	TO WALL : 0° AWAY WALL : 3°	Selectable
Detectable speed	0.3 to 2.0 m/s (1' to 6.7"/s)	
Sensitivity	Normal ; 2.0 °C (3.6°F) at 0.6 m/s Extreme High ; 1.0 °C (1.8°F) at 0.6 m/s Selectable for each side individually	
Power input	9.5 to 18 VDC	
Current draw (except walk test)	31 mA max. at 12 VDC	34 mA max. at 12 VDC
Alarm period	2.0 ±1 sec.	
Warm-up period	60 sec. or less (LED blinks)	
Alarm (R) output	28 VDC 0.1 A max. [Individual;Right or General], [N.O. or N.C.] are selectable	
Alarm (L) output	28 VDC 0.1 A max. [Individual;Left or General], [N.O. or N.C.] are selectable	
Trouble output	-	N.C. 28 VDC 0.1 A max.
Tamper output	N.C. 28 VDC 0.1 A max. open when face cover, main unit or base unit is removed	
LED indicator	Red LED ; 1. Warm-up 2. Alarm (DIP switch ON or Walk test)	Red LED ; 1. Warm-up 2. Alarm 3. Masking detection (DIP switch ON or Walk test)
Operation temperature	-30 °C to +60 °C (-22°F to +140°F)	
Environment humidity	95% max.	
International protection	IP 55	
Mounting	Wall, Pole (Outdoor,Indoor)	
Mounting height	0.8 to 1.2 m (2'7" to 4')	
Weight	430 g (15.2 oz.)	
Accessories	Screw (4 x 20 mm) x 2	

• Specifications and designs are subject to change without prior notice.
• These units are designed to detect an intruder and activate an alarm control panel. Being only a part of a complete system, we cannot accept responsibility for any damages or other consequences resulting from an intrusion.

FR

Modèle	BXS-ST	BXS-AM
Méthode de détection	Infrarouge passif	
Couverture PIR	24 m (80') ; 12 m (40') de chaque côté 4 zones ; 2 zones de chaque côté, 180° étroite	
Limite de distance PIR	2,5 à 12 m (5 niveaux)	
Angle de détection du mur	TO WALL : 0° AWAY WALL : 3° sélectionnable	
Vitesse détectable	0,3 à 1,5 m / s (1' à 6'7" / s)	
Sensibilité	Normal ; 2,0 °C (3,6°F) à 0,6 m/s Extrême Haute ; 1,0 °C (1,8°F) à 0,6 m/s Sélectionnable pour chaque côté individuellement	
Alimentation	9,5 à 18 Vcc	
Consommation de courant (sauf test de marche)	31 mA max. à 12 Vcc	34 mA max. à 12 Vcc
Période d'alarme	2,0 ± 1 sec.	
Période de chauffe	60 sec. ou moins (Clignote LED)	
Sortie d'alarme (R)	28 Vcc 0,1 A max. [Individuel; Droite ou Général], [N.O. ou N.C.] sont sélectionnables	
Sortie d'alarme (L)	28 Vcc 0,1 A max. [Individuel; Gauche ou Général], [N.O. ou N.C.] sont sélectionnables	
Sortie problème	-	N.C. 28 Vcc 0,1 A max.
Sortie autoprotection	N.C. 28 Vcc 0,1 A max. ouvert lorsque la couverture de visage, l'unité principale ou la base est enlevée.	
Indicateur LED	LED rouge ; 1. Chauffe 2. Alarm (Interrupteur DIP ON ou Test de marche)	LED rouge ; 1. Chauffe 2. Alarm 3. Détection de masquage (Interrupteur DIP LED ON ou Test de marche)
Température de fonctionnement	-30 °C à +60 °C (-22°F à +140°F)	
Humidité	95% max.	
Protection Internationale	IP 55	
Montage	Mur, poteau (extérieur, intérieur)	
Hauteur de montage	0,8 à 1,2 m (2'7" à 4')	
Poids	430 g (15,2 oz.)	
Accessories	Vis (4 x 20 mm) x 2	

- Les spécifications et design sont sujets à modifications sans information préalable de notre part.
- Ces appareils sont conçus pour détecter un intrus et pour actionner un panneau de contrôle d'alarme. Comme ils font partie d'un système complet, nous ne pouvons accepter aucune responsabilité pour aucun dommage ou autre conséquence d'une intrusion.

DE

Modell	BXS-ST	BXS-AM
Erkennungsverfahren	Passives Infrarot	
PIR-Überdeckung	24 m ; 12 m auf jeder Seite 4 Zonen ; 2 Zonen auf jeder Seite, 180° schmal	
PIR-Distanzlimit	2,5 bis 12 m (5 Stufen)	
Erfassungswinkel von der Wand	TO WALL : 0° AWAY WALL : 3° Wählbar	
Erkennungsgeschwindigkeit	0,3 to 2,0 m/S	
Sensitivität	Normal ; 2,0 °C bei 0,6 m/S Extrem Hoch ; 1,0 °C bei 0,6 m/S Wählbar für jede Seite einzeln	
Stromeinspeisung	9,5 bis 18 VDC	
Stromaufnahme (Außer Gehtest)	31 mA max. bei 12 VDC	34 mA max. bei 12 VDC
Alarmdauer	2,0 ± 1 Sekunden	
Aufwärmphase	60 Sekunden oder weniger. (LED blinkt)	
Alarmausgang (R)	28 V DC 0,1 A (max.) [Einzel; Recht oder General], [N.O. oder N.C.] wählbar sind	
Alarmausgang (L)	28 V DC 0,1 A (max.) [Einzel; Links oder General], [N.O. oder N.C.] wählbar sind	
Störungsausgang	-	N.C. 28 V DC 0,1 A (max.)
Sabotageausgang	N.C. 28 V DC 0,1 A (max.) Öffnen, wenn Gesicht-Abdeckung, Haupteinheit oder Grundeinheit entfernt wird	
LED-Anzeige	Rote LED ; 1. Aufwärmen 2. Alarme (DIP-Einstellung ist ON oder Gehtest)	Rote LED ; 1. Aufwärmen 2. Alarme 3. Masking-Erkennung (DIP-Einstellung ist ON oder Gehtest)
Betriebstemperatur	-30 °C bis +60 °C	
Umgebungsluftfeuchtigkeit	Max. 95%	
Internationale Schutzarten	IP 55	
Montage	Wand, Pfahl (Außen- und Innenbereich)	
Montagehöhe	0,8 bis 1,2 m	
Gewicht	430 g	
Zubehör	Schrauben (4 x 20 mm) x 2	

- Die technischen Daten und das Design können ohne vorherige Bekanntgabe geändert werden.
- Diese Geräte sind so konzipiert, dass sie einen Eindringling erkennen und einen Alarm auf dem Bedienfeld aktivieren. Da diese nur Teil eines Gesamtsystems sind, übernehmen wir keine Haftung für Schäden oder sonstige Konsequenzen, die durch einen Eindringling entstehen.

IT

Modello	BXS-ST	BXS-AM
Modalità di rilevazione	Infrarosso passivo	
Copertura rivelatore PIR	24 m ; 12 m su ciascun lato 4 zone ; 2 zone su ciascun lato, 180° stretto	
Limiti di distanza	Da 2,5 a 12 m (5 livelli)	
Angolo di rilevamento da parete	TO WALL : 0° AWAY WALL : 3° Selezionabile	
Velocità rilevabile	Da 0,3 a 2,0 m/s	
Sensibilità	Normale ; 2,0°C a 0,6 m/s Estremo Alta ; 1,0°C a 0,6 m/s Selezionabile per ciascun lato individualmente	
Alimentazione	Da 9,5 a 18 Vc.c.	
Assorbimento di corrente (tranne prova di movimento)	Massimo 31 mA a 12 Vc.c.	Massimo 34 mA a 12 Vc.c.
Tempo di allarme	2,0 ± 1 sec.	
Tempo di riscaldamento	60 sec. o meno (il LED lampeggia)	
Uscita d'allarme (R)	28 Vc.c. 0,1 A (mass.) [Individuale; Destra o Generale], [N.A. o N.C.] sono selezionabili	
Uscita d'allarme (L)	28 Vc.c. 0,1 A (mass.) [Individuale; Sinistra o Generale], [N.A. o N.C.] sono selezionabili	
Uscita guasto	-	N.C. (norm. chiuso) 28 Vc.c. 0,1 A (massimo)
Uscita manomissione	N.C. (norm. chiuso) 28 Vc.c. 0,1 A (mass.) aperto quando il coperchio fronte, sull'unità principale o unità base viene rimossa	
Indicatore LED	LED rosso ; 1. Riscaldamento 2. Alarm (Interruttore DIP ON o Prova di movimento)	LED rosso ; 1. Riscaldamento 2. Alarm 3. Rilevamento di mascheramento (Interruttore DIP ON o Prova di movimento)
Temperatura di funzionamento	Da -30 a 60 °C	
Umidità ambientale	Massimo 95%	
Protezione Internazionale	IP 55	
Posizioni di fissaggio	A parete o su palo (interni o esterni)	
Altezza di fissaggio	Da 0,8 a 1,2 m	
Peso	g 430	
Accessori	Viti (da 4 x 20 mm) x 2	

- Le caratteristiche tecniche e l'aspetto del rivelatore sono soggetti a modifiche senza preavviso.
- Questi unità rilevano le intrusioni e inviano un allarme a un pannello di controllo. Essendo tuttavia soltanto componenti di sistemi completi, non accettiamo alcuna responsabilità per eventuali danni o altre conseguenze risultanti da tali intrusioni.

ES

Modelo	BXS-ST	BXS-AM
Método de detección	Infrarrojos pasivos	
Cobertura PIR	24 m (80') ; 12 m (40') en cada lado 4 zonas ; 2 zonas en cada lado, 180° estrecho	
Límite distancia PIR	2,5 a 12 m (5 posiciones)	
Ángulo de cobertura de la pared	TO WALL : 0° AWAY WALL : 3° Seleccionable	
Velocidad detectable	0,3 a 2,0 m/s (1' a 6'7"/s)	
Sensibilidad	Normal ; 2,0 °C (3,6°F) a 0,6 m/s Extremo Alto ; 1,0 °C (1,8°F) a 0,6 m/s Seleccionable para cada lado de forma individual	
Alimentación	9,5 a 18 VCC	
Consumo de corriente (salvo prueba de funcionamiento)	31 mA máx. a 12 VCC	34 mA máx. a 12 VCC
Periodo alarma	2,0 ± 1 seg.	
Periodo de calentamiento	60 seg. o menos (LED parpadean)	
Salida alarma (R)	28 VCC 0,1 A máx. [Individual; Derecha o General], [N.O. o N.C.] son seleccionables	
Salida alarma (L)	28 VCC 0,1 A máx. [Individual; Izquierda o General], [N.O. o N.C.] son seleccionables	
Salida de problemas	-	N.C. 28 VCC 0,1 A máx.
Salida de antisabotaje	N.C. 28 VCC 0,1 A máx. abierto cuando se retira la cubierta cara, la unidad principal o la unidad base	
Indicador LED	LED rojo ; 1. Calentamiento 2. Alarma (Conmutador DIP ON o Prueba de funcionamiento)	LED rojo ; 1. Calentamiento 2. Alarma 3. Mascaramiento (Conmutador DIP ON o Prueba de funcionamiento)
Temperatura de trabajo	-30 °C a +60 °C (-22°F a +140°F)	
Humedad ambiente	95% máx.	
Protección Internacional	IP 55	
Montaje	Pared, postes (exteriores, interiores)	
Altura de montaje	0,8 a 1,2 m (2'7" a 4')	
Peso	430 g (15,2 oz.)	
Accesorios	Tornillo (4 x 20 mm) x 2	

- Las especificaciones y el diseño pueden sufrir modificaciones sin previo aviso.
- Estas unidades han sido diseñadas para detectar intrusos y activar un panel de control de alarma. Al ser sólo una parte de un sistema completo, no podemos aceptar la responsabilidad de ningún daño o consecuencia resultante de una intrusión.

PT

Modelo	BXS-ST	BXS-AM
Método de detecção	Infravermelho Passivo	
Cobertura do PIR	24 m (80'); 12 m (40') em cada lado 4 zonas; 2 zonas em cada lado, 180°limitar	
Limite de distância PIR	2,5 a 12 m (5 níveis)	
Ângulo de detecção de parede	TO WALL : 0° AWAY WALL : 3° Selecionável	
Velocidade detectável	0,3 a 2,0 m/s (1' a 6'7"/s)	
Sensitivity	Normal ; 2,0 °C(3,6°F) a 0,6 m/s Extremo Alto ; 1,0 °C(1,8°F) a 0,6 m/s Selecionável para cada lado individualmente	
Alimentação	9,5 a 18 VDC	
Consumo de corrente (exceto teste de caminhada)	31 mA máx. a 12 VDC	34 mA máx. a 12 VDC
Período de alarme	2,0 ±1 sec.	
Período de aquecimento	60 s ou menos. (LED pisca)	
Saída de alarme (R)	28 VDC 0,1 A máx. [Individual;Direito ou Geral], ou [N.A. ou N.F.] são selecionáveis	
Saída de alarme (L)	28 VDC 0,1 A máx. [Individual;Esquerda ou Geral], ou [N.A. ou N.F.] são selecionáveis	
Saída de problemas	-	N.F. 28 VDC 0,1 A máx.
Saída de sabotagem	N.F. 28 VDC 0,1 A máx. abrir quando a cobrir o rosto, unidade principal ou unidade de base é removido	
Indicação do LED	LED vermelho; 1. Aquecimento 2. Alarme (Chave DIP ON ou teste de caminhada)	LED vermelho; 1. Aquecimento 2. Alarme 3. Mascaramento (Chave DIP ON ou teste de caminhada)
Temperatura de operação	-30 °C a +60 °C (-22°F a +140°F)	
Umidade ambiente	95% máx.	
Prova de intempéries	IP 55	
Montagem	Parede, Poste (Ambiente externo, interno)	
Altura de montagem	0,8 a 1,2 m (2'7" a 4')	
Peso	430 g (15,2 oz.)	
Acessórios	Parafusos (4 x 20 mm) x 2	

- As especificações e o design estão sujeitos à alteração sem aviso prévio.
- Essas unidades foram projetadas para detectar um intruso e ativar um painel de controle de alarme. Sendo apenas parte de um sistema completo, não podemos aceitar a responsabilidade por quaisquer danos ou outras consequências resultantes de uma intrusão.

NL

Modelo	BXS-ST	BXS-AM
Detectiemethode	Passieve infrarood	
PIR bereik	24 m ; 12 m aan elke kant 4 zones ; 2 zones aan elke kant, 180°smal	
PIR afstandslimiet	2,5 tot 12 m (5 niveaus)	
Detectie hoek van de muur	TO WALL : 0° AWAY WALL : 3° Selecteerbaar	
Detecteerbare snelheid	0,3 tot 2,0 m/s	
Gevoeligheid	Normaal ; 2,0 °C bij 0,6 m/s Extrem Hoog ; 1,0 °C bij 0,6 m/s Selecteerbaar voor elke zijde afzonderlijk	
Stroomvoorziening	9,5 tot 18 V gelijkspanning	
Stroomverbruik (behalve looptest)	Maximaal 31 mA bij 12 V gelijkspanning	Maximaal 34 mA bij 12 V gelijkspanning
Alarmperiode	2,0 ±1 sec.	
Opwarmingsperiode	60 sec. of minder (LED-knipperlichten)	
Alarmuitgang (R)	28 V gelijkspanning 0,1maximaal [Individueel;Rechts of General], [N.O. of N.C.] worden geselecteerd	
Alarmuitgang (L)	28 V gelijkspanning 0,1maximaal [Individueel;Links of General], [N.O. of N.C.] worden geselecteerd	
Problemen met output	-	N.C. 28 V gelijkspanning 0,1 A maximaal
Sabotage-uitgang	N.C. 28 V gelijkspanning 0,1 A maximaal; open wanneer gezicht te bedekken, hoofdeenheid of basiseenheid wordt verwijderd	
LED-indicator	Rode LED; 1. Opwarmen 2. Alarm (DIP-switch AAN of looptest)	Rode LED; 1. Opwarmen 2. Alarm 3. Maskeringsdetectie (DIP-switch AAN of looptest)
Bedrijfstemperatuur	-30 °C tot +60 °C	
Luchtvochtigheid omgeving	95% max.	
Internationale bescherming	IP 55	
Bevestiging	Wand, paal (buitenshuis, binnenshuis)	
Bevestigingshoogte	0,8 tot 1,2 m	
Gewicht	430 g	
Accessoires	Schroef (4 x 20 mm) x 2	

- Technische gegevens en ontwerp kunnen zonder voorafgaande kennisgeving worden gewijzigd.
- Deze eenheden zijn ontworpen om een indringer waar te nemen en een alarmbedieningspaneel te activeren. Omdat het slechts een deel van een compleet systeem is, kunnen wij geen verantwoordelijkheid voor eventuele schade of andere gevolgen van een inbreuk accepteren.

8 Dimensions

FR Dimensions DE Abmessungen IT Dimensioni
ES Dimensiones PT Dimensões NL Afmetingen

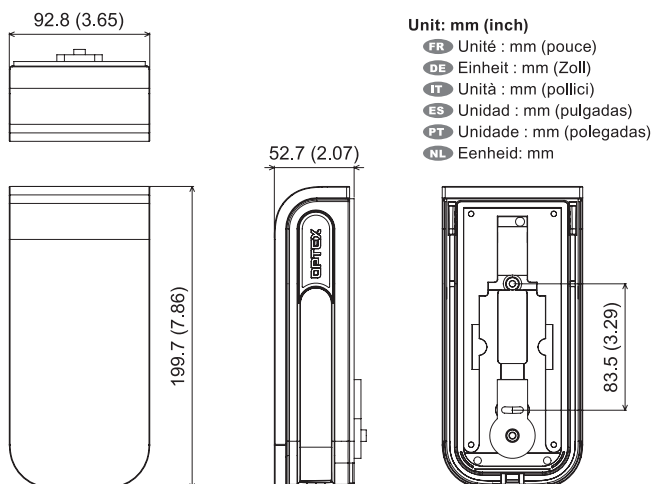

EU contact information

Manufacturer:
OPTEX CO., LTD.
5-8-12 Ogoto, Otsu, Shiga, 520-0101 JAPAN

Authorised representative in Europe:
OPTEX (EUROPE) LTD. / EMEA HEADQUARTERS
Marandaz House 1 Cordwallis Park, Clivemont Road,
Maidenhead, Berkshire, SL6 7BU U.K.



OPTEX CO., LTD.(JAPAN)

URL: <http://www.optex.net>

OPTEX INC. (U.S.)
URL: <http://www.optexamerica.com>

OPTEX DO BRASIL LTDA. (Brazil)
URL: <http://www.optex.net/br/es/sec>

OPTEX (EUROPE) LTD. / EMEA HQ (U.K.)
URL: <http://www.optex-europe.com>

OPTEX TECHNOLOGIES B.V. (The Netherlands)
URL: <http://www.optex.eu>

OPTEX SECURITY SAS (France)
URL: <http://www.optex-security.com>

OPTEX SECURITY Sp.z o.o. (Poland)
URL: <http://www.optex.com.pl>

OPTEX PINNACLE INDIA, PVT., LTD. (India)
URL: <http://www.optex.net/in/en/sec>

OPTEX KOREA CO.,LTD. (Korea)
URL: <http://www.optexkorea.com>

OPTEX (DONGGUAN) CO.,LTD.
SHANGHAI OFFICE (China)
URL: <http://www.optexchina.com>

OPTEX (Thailand) CO., LTD. (Thailand)
URL: <http://www.optex.net/th/th>