



# INSTALLER REFERENCE GUIDE

Rev 1.20



## RF120 SMART RF Base Station - RS485



# RF120 - SMART RF BASE STATION - RS485

The SMART RF Base Station is an advanced 2-Way 433mhz transceiver that interfaces directly to compatible control panels via an RS485 LAN connection. There are two built in radio transmitters and receivers with dual diversity internal antennas. Indicator lights display the status at all times while front and rear tampers protect against unauthorised access.

Multiple RF120's receivers can be installed on a single LAN creating a network of access points where RF devices can communicate across larger areas.

RF120 Base Station Receiver Compatibility		
Panels Supported	Version	Receivers Supported
Vision-X	2.30	4
Solution 6000	2.30	4

Table 1: RF120 Compatibility

The 2-way communication is encrypted with rolling code and anti substitution technology making the RF120 an ideal choice for your wireless security system.

## Receiver Addressing

Each receiver fitted to the system must be assigned a unique address on the LAN. The RF120 includes a DIP switch for quick address selection. The following table shows the address setting for each keypad as well as the number of keypad devices each panels can support.

Keypad Address Setting						
	Address	S1	S2	S3	S4	S5
Base Station	1	OFF	OFF	OFF	OFF	LAN Terminator Switch
	2	ON	OFF	OFF	OFF	
	3	OFF	ON	OFF	OFF	
	4	ON	ON	OFF	OFF	

Table 2: Receiver Address



Only 1 receiver can be assigned to each address. All receivers are supplied from the factory set to address 1. You must power cycle the panel or perform a LAN scan whenever you change the address. Currently only 4 receivers are supported.

## DIP Switch 5

LAN Termination if required can be enabled by placing switch 5 in the ON position.



Figure 1: Receiver Address Switch

## Tamper Switch Operation

In your installation one or both of the case tamper switches may not be needed. Setting switch 1 to the ON position will disable the rear case tamper and switch 2 in the ON position will disable the front cover tamper. From the factory both tampers are enabled. The housing must be correctly installed for the rear tamper to function correctly.

Switch 1 ON = Disable Rear Tamper

Switch 2 ON = Disable Front Tamper

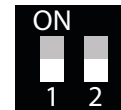

Figure 2: Tamper Switch Control

## Box Contents

The RF120 box contains the following parts.

- RF Base Station Receiver
- Case (Front & Back) + LED Light Pipe + Cam Lock
- Instruction Sheet

## Bosch RF Device Compatibility

The RF120 Base Station is capable of supporting selected Bosch RF peripherals like PIR's, Reed Switches and Shock Sensors etc. You must enable Bosch compatibility mode in panel programming, MENU 6-2-0, Option 8 to enable this feature.

For best performance, if you are not using Bosch RF peripherals then you should leave this option disabled.

## Mounting Considerations:

- The receiver should be mounted in a location that is central relative to where the wireless devices will be mounted.
- The receiver should be mounted on a vertical surface with at least 30 cm clearance from other objects as the antennas are internal.
- Avoid mounting the receiver in areas with significant metal or electrical wiring.
- Avoid mounting the receiver in areas where it may be exposed to moisture or high humidity.
- Reception distances are generally improved with higher mounting locations and with no metal objects near the unit.
- If range is not achievable due to environmental or specification limitations then add additional receivers.

ers as required in strategic locations. Up to 4 receivers can be added.

### Installation

The receiver should be installed onto a solid surface using suitable mounting fixtures. Wiring should only be performed while the control panel is powered down.

Step 1) Unlock and remove the front of the housing by turning the cam lock anti-clockwise [Figure 4] then release the spring clips and remove the PCB, This will expose the mounting and tamper screw holes.

Step 2) Mark out the location of the mounting holes and the cable exit hole before drilling out all

points as necessary. Secure the case using fixtures appropriate for the wall construction type. **Make sure to fit the rear tamper screw when mounting as shown.**

Step 3) Feed any wires into the case via the knockouts provided and then replace the PCB by inserting from the terminal side first and then clipping the other side in.

Step 4) Set the address for the module and connect and necessary wiring. Unused wires should be insulated to prevent short circuits.

Step 5) Once all connections are secure and the case is mounted, secure the front case and lock in place by turning the cam lock in a clockwise direction.

**CAUTION - Figure 3 below is a guide only and is not a 1:1 mounting template for the RF120. Do not scale.**

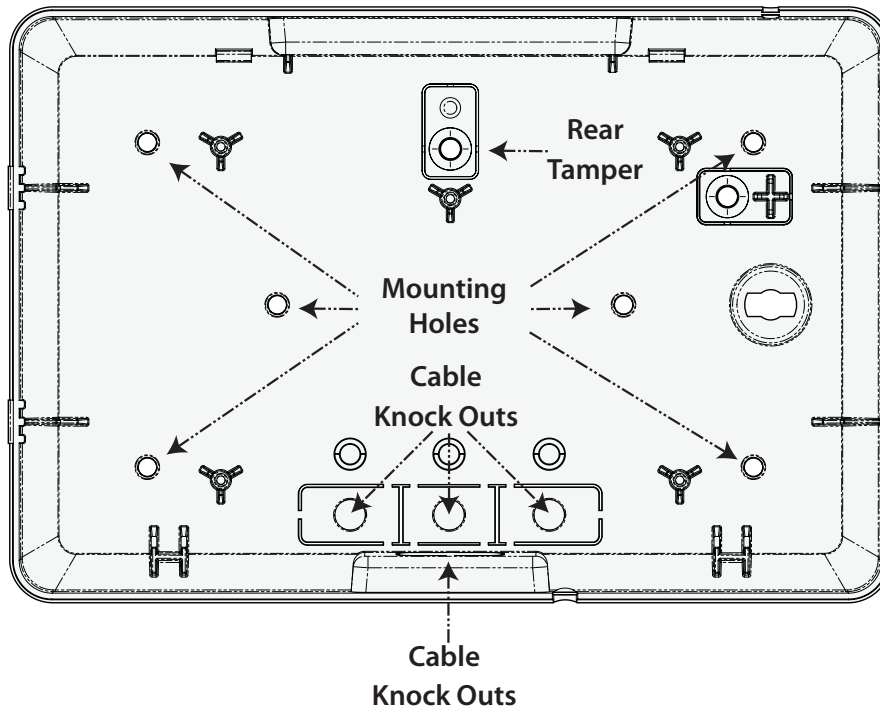

Figure 3: Mounting Holes, Cable Knock Out's & Rear Tamper Locations

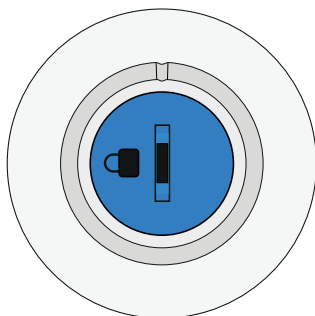

Figure 4: Cam Lock Shown In The Unlock Position

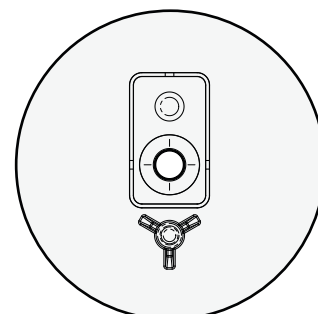

Figure 5: Rear Tamper Screw

## Receiver Operation

At start up the control panel will configure the receiver with all the necessary information. The RF120 will receive information and then send an acknowledge to the RF device if it supports 2-way communication. For RF devices that are only one way then no acknowledge is sent.

Where two or more RF120 receivers are required to achieve the desired coverage area there can be overlapping areas where multiple receivers detect the same RF device. The system will determine the receiver with the strongest signal level and process it accordingly. The seamless operation and wide coverage area using a LAN connection allows easy deployment of receivers over the full 1km control panel LAN length.

## Receiver LED Indicators

The RF120 Base Station includes RED and GREEN LED indicators which provide visual feedback during system operation. See Table 3 for information on the indicator colours and meanings.

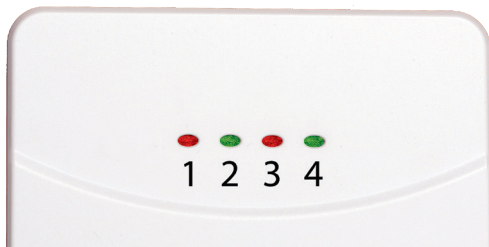

Figure 6: RF120 LED Indicators

## Multiple Receiver Wiring Connection

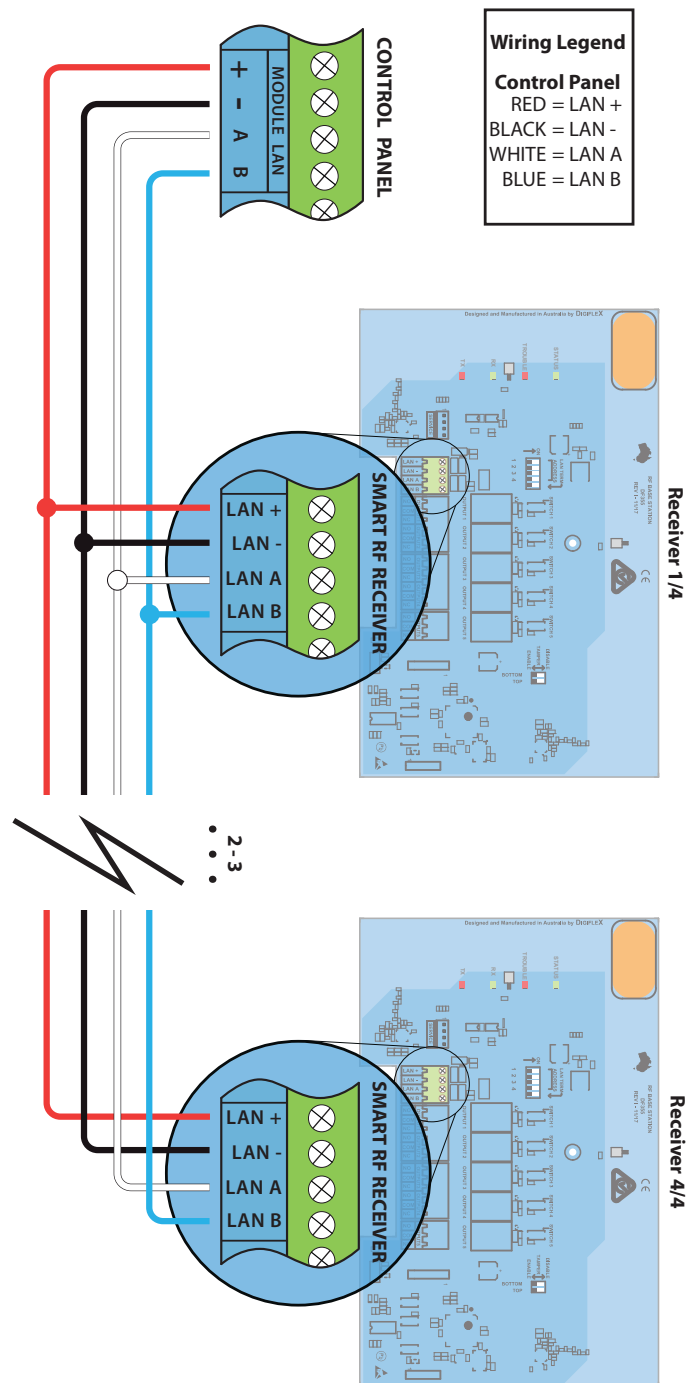

Figure 7: RF120 LAN Wiring

Module Indicator Lights			
Position	Colour	Meaning	Meaning
1	Red	RF Transmit	Blinks each time a packet is sent to a device. In most cases this will blink as an acknowledge is sent to a 2-way device. Blinks each time a valid RF packet is received.
2	Green	RF Receive	Blinks each time a valid RF packet is received.
3	Red	Trouble	Turns on when the receiver has detected a fault. This could be a tamper or jamming levels exceeded. For a self diagnostic issue the LED will slowly blink.
4	Green	Status	Blinks each time the system is polled by the control panel.

Table 3: Receiver LED Indicator Descriptions

## Configuring RF110 Keyfob Button Functions

MENU 6-2-6 is used to customise the button functions on the RF110 SMART RF 2-way keyfobs. Each of the 5 buttons can be programmed with two independent functions if required with buttons 1 to 5 being a single press function and buttons 6 to 10 being hold down functions.

Up to 10 different functions in total can be programmed.



Figure 8: RF110 SMART RF Keyfob



To trigger the hold down function you must press and hold the keyfob button down for 2 seconds.



MENU 6-2-6 SMART RF Keyfob Function is only effective when using the RF110 keyfobs. Other keyfobs have fixed button functions that cannot be configured separately.

- 1 Disabled
- 2 Disarm
- 3 Arm
- 4 Part 1
- 5 Part 2
- 6 Door
- 7 Output
- 8 Macros

- 5) Once the button functions have been configured you need to set the function assignments for each button. Select the Button Assignment option from MENU 6-2-6 and press OK. Select the button to configure and press OK.
- 6) The type of assignment available for each button is determined by the button's function.

The button functions Disarm, Arm, Part 1 and Part 2 must be assigned to one or more areas. The button function Door must be assigned to a door, button function Output to an output and button function Macro to a macro.

- 7) Using macros, it is possible to configure a single button to open multiple doors or to operate multiple outputs.

### SMART Keyfob Function

**I** MENU 6-2-6

- 1) Press [MENU] + [6] + [2] + [6]. The keypad will display the following options.

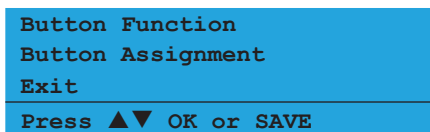

- 2) Use the up and down arrow keys to select the Button Function option and press OK.
- 3) Use the up and down arrow keys to select the Button to program (1- 10) and press OK. Remember buttons 6 to 10 are hold down functions.
- 4) Use the up and down arrow keys to select the required function from the list of options and press OK.

The following button functions are currently available.

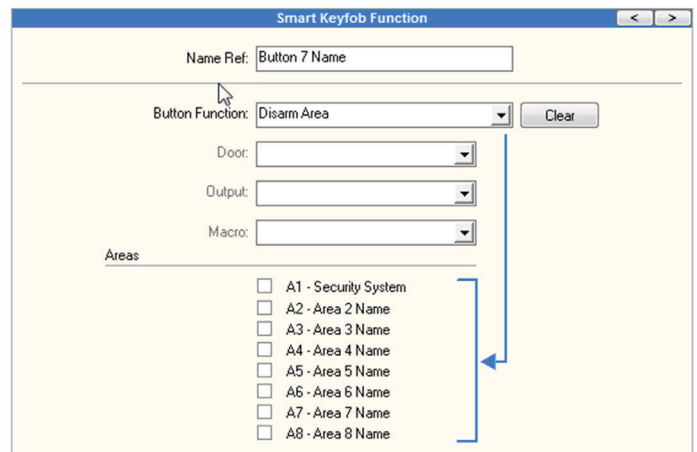

Figure 9: SMART Keyfob Functions In RAS Software

### **Optional RF110FK Fascia Kit**

An option fascia kit is available to allow customers to personalise their keyfob or to match corporate colours etc. Each kit is supplied with 7 different coloured fascias which have been pre installed onto top covers.

To change a fascia simply remove the screw from the back of the keyfob, lift off the existing top cover and fascia then replace with the new colour. Note keyfob rubber keymats are not supplied with the kits.



*Figure 10: RF110FK Fascia Kit*

## RF120 Connections

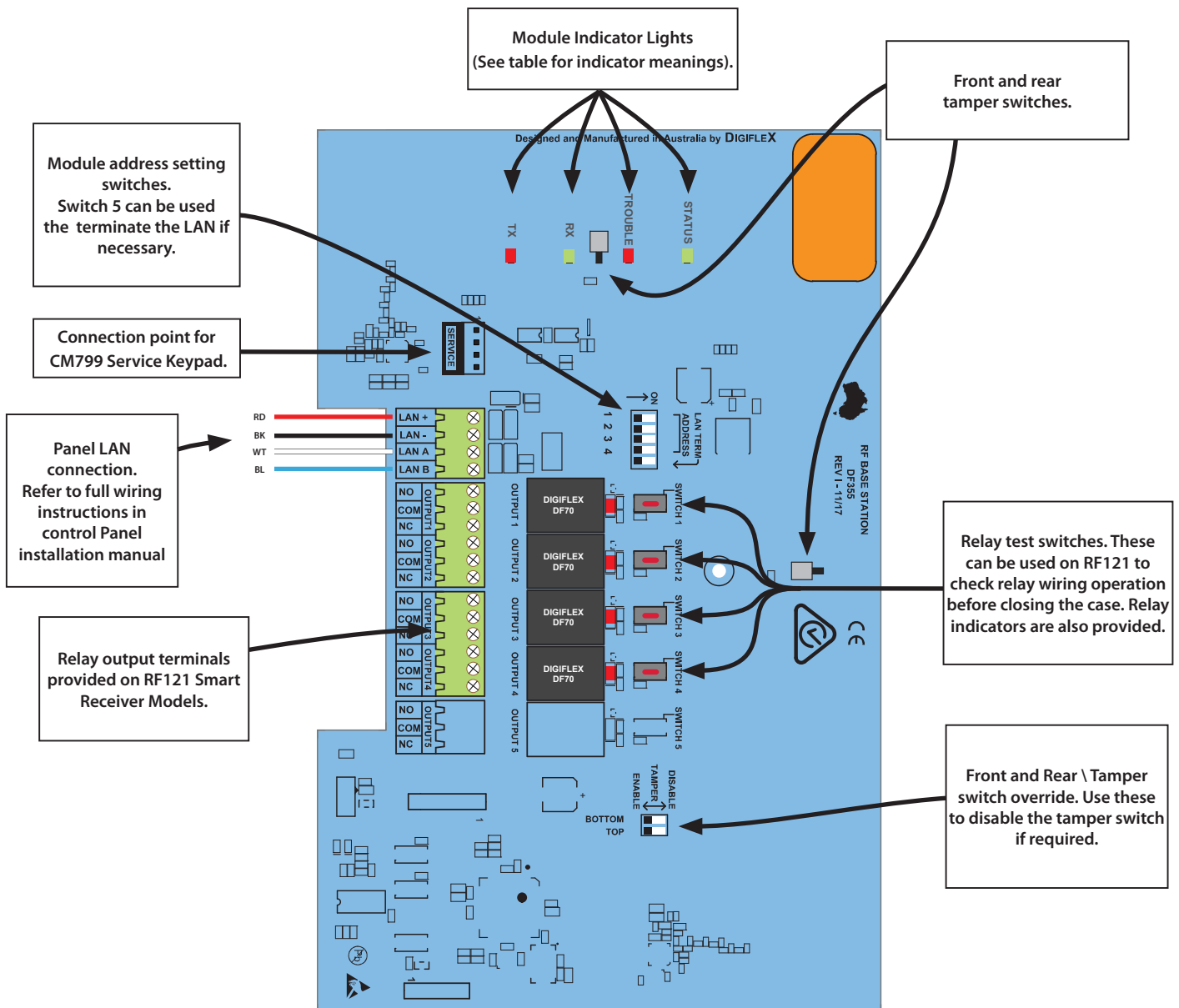

Figure 11: RF120 / RF121 Connection Diagram

## RF120 Specifications

<b>Part Number:</b>	RF120 - SMART RF Base Station - RS485
<b>Operating Voltage:</b>	10V D.C. - 14V D.C. @ 70mA Max. 12V D.C. .nominal
<b>Module Connection:</b>	RS485 LAN
<b>Frequency:</b>	433.42 MHz
<b>Dimensions:</b>	140mm(W), 40mm(D), 270mm(H)
<b>Environment:</b>	0° to 49°C Indoors
<b>Fixing Method:</b>	Using mounting screws fix unit on a vertical surface in either landscape or portrait orientation.
<b>Warranty:</b>	3 years from date of manufacture (return to base).



In the interest of ongoing product development this document is subject to change without notice.



**DIGIFLEX PTY LTD**

18 Brumby Street  
Seven Hills NSW 2147  
AUSTRALIA  
Phone: (+612) 97417000

Email: [sales@digiflex.com.au](mailto:sales@digiflex.com.au)  
[www.digiflex.com.au](http://www.digiflex.com.au)

***Our Vision Is Your Peace Of Mind***

