

USER MANUAL

# SMART IP VIDEOPHONE

KCV-S701IP2W

---

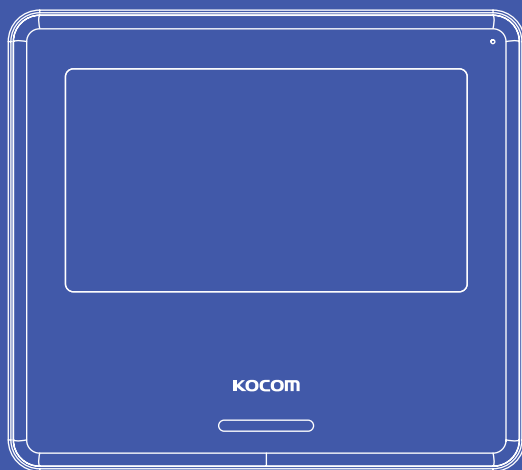

Thank you for purchasing our product.  
Read safety instructions and manual  
carefully before using the product.

**KOCOM HOME APP** is available on 'Google Play' and 'App Store'



APP Download

# Cautions for safety

For safe use, please stick to the following cautions.

- Please, save this manual after reading these instructions carefully.
- Read and understand all instructions to set up rightly.
- This Cautions for Safety may include items that are not contained in specifications of the product that consumer purchases.
- If you need assistance with the set-up or operation, please contact with A/S center.

## The important marks in the manual.

To help our customers to understand this manual, to prevent any personal injury or property damage, some marks are used in the manual. The marks and the drawing signs are below. Please, understand the marks before reading the manual.

## The meaning of the drawing signs.



Sign to show what not to do.



Mishandling the device with ignoring this sign may result in serious injury or death.



Mishandling the device with ignoring this sign may result physical injury or material damage.



Sign to tell you that you should follow the instructions.



Sign to tell you that you need more attention including (high voltages, electric shock, danger, warning)



Sign to tell you that you can't disassemble this unit.



Sign to tell you that you must unplug the unit.



## Caution

### ▶ Cautions for set-up

- The law limits distributing the power lines to an authorized person from government.
- The work from an unauthorized person cause fire or electric shock.
- Place this unit securely on a stable surface. Serious damage and/or injury may result if the unit falls.
- Do not set up this unit near the leaking place because it may expose you to dangerous voltages or other risks.
- Even if your product is water proof, do not install it slanted place of water leakage, which can a short circuit.
- Fix the product on the wall safely according to the installation guideline to prevent any damage or injury.
- Don't put any stuff in 30cm around the monitor, not to block the air hole.
- The work of distributing wires needs skills and experiences. So please, for assistance, contact your dealer or call service center.
- The communication lines should be built in being distant from the power source.



- This may result in the risk of fire, electric shock and communication disorder.
- Setting the communication lines in a high humid place such as outside without any protection from rain causes the communication disorder.
- Keep the hook at the wall-mounted device safe. The hook may cause the physical injury.
- Think about the thickness and quality of wall material. The unqualified material may make the device fall.



- Set the device of the wall-mounted type not to fall. Falling from an earthquake causes personal injury.

### ▶ Cautions for Repairs and Maintenance

- Keep the inside of the device clean. Having the dust inside without any cleaning for a long time causes the fire.
- If necessary, contact your dealer or service center to get cleaning service.
- Unplug this device when you want to check the inside. If there is no plug, please, turn off the circuit breaker.
- Unplug this device when you try to move it to another place.
- If the electric line is connected inside of the unit, please contact your dealer or service center.



- Do not use liquid or aerosol cleaners. Use a damp cloth for cleaning.



## Warning

### ▶ Warnings for Usage

- Do not install this unit near the water and dust, for example, in a bathroom or near the washing machine. It caused fire and electric shock.
- Do not install this unit near the fire, for example, near kitchen sink, heater or the like.
- Do not install near the noxious gas such as Hydrogen Sulfide, metal powder and the like.
- Do not install near the water and chemicals.
- Do not give any damage, break and modify the plug. Overloading, heating, pulling causes the damage.
- Do not place the plug near the heater. The damaged code causes fire and electric shock. Do not pull the power code when unplugging.
- The damaged code causes fire and electric shock. Must pull with plug. Do not touch with wet hands. It causes the electric shock.
- Do not use any other voltage, except the marked regular voltage.
- Do not use the power terminal at the units to other electric device except the designed device.
- Do not install the units at the leaking place if it doesn't have any waterproof mark. Do not install the unit when the power is on.
- Install the circuit breaker after checking the safety such as electric shock and leakage. Turn off the power before you install or A/S



- Check the suitability of the lines for installing when you use the exiting lines.
- Do the wiring work by using the designed material.
- Connect the electric wire with the designed ways and ground.
- Do not connect with any other devices except the designed devices to compose the system.



- Unplug electric wire and communication lines from the units before moving to another place.

## ⦿ Cautions for Use

- This unit is not designed for security purpose.
- Do not place a pot with water or a small metal material on the Units.
- Do not cover the ventilating opening or put any metal material in the units.
- During thunderstorms, avoid using this unit. There may be a remote risk of an electric shock from lightning.
- Do not modify the unit.
- Do not handle the unit with the wet hands.
- Open the main gate after checking ID if the image and sound system do not work. Call A/S



## ⦿ Cautions for Abnormality

- Change the damaged electric code.
- Unplug this unit from plug socket and refer servicing to an authorized service center when the following conditions occur:
  - If liquid has been spilled into the unit.
  - If the unit does not work normally by following the operating instructions.
  - If the unit exhibits a distinct change in performance.
  - If the unit has been dropped or physically damaged.
- The mains plug, as a disconnection device, shall remain readily accessible by the user.



# Caution

## ⦿ Safety Instructions, Warnings and Cautions of Each System

- Do not disassemble this unit as will as this device is composed by precision parts.
- Do not touch or insert any foreign substances, for example, sticker, magnetic, opener and the like.
- Make U-type at the end of wires at the rain can effect on the system by following the wires during the rainy season.
- Install the unit by following the set-up instructions of Kocom.

## ⦿ Videophone

- Separate the AC/DC lines with the hook of the wall-mounted type when installing.
- Do not distribute signal line with AC line.
- Do not clean the LCD with the damp cloth for cleaning. Use the only dry and soft cloth.
- Connect the lines after peeling the wires properly.
- Use the designed driver to connect the lines to terminal.
- Do not install the main gate monitor at the leaking place.

## ⦿ Things You Need to Know

- This product is designed as a home videophone and cannot use continuously like monitor camera.
- If there is temperature difference between inner part of camera and surrounding, dew condensation occurs on camera lens and may disturb image. If dew condensation is removed from camera lens, image quality recovers.
- White LED light examination range is narrower than camera shot range at night, so there is less amount of light at night than day.
  - So it is difficult to see the face in low illumination condition due to noise increase on screen, but it is not from defect.
- Monitor screen (liquid crystal panel) is not in defect when some pixels always light or black out.
- Please install monitor and camera over 5cm away.
  - Also, avoid installing at a place with too much noise, because too much noise around camera causes phone call inferiority.
- Do not place an object within 20cm in front of monitor. It causes phone call inferiority, especially because microphone is installed at the top of monitor.
- If strong light such as sunlight flows into camera module, screen saturation (or strange mark) and image shaking might occur.
- This is not a defect, so please do not install camera where a direct ray of light do not flow if possible.

## ⦿ Cautions

- In some cases there is occurrence of product destruction, malfunction, noise mixing and picture quality deterioration due to mixing of other tool's induced, voltage or thunder with communication wiring of monitor/camera, monitor/extended monitor.
- Do not wire with power line such as outdoor wiring or AC power, or phones and other tools.
- You cannot use it if you incorrectly wire the AC voltage between monitor/camera, monitor/extended monitor.
  - Call the store or agency where you purchased this product and consult to solve the problem.
  - Beware that unfixable damage might be caused due to authorizing AC voltage on communication wiring of monitor/camera, monitor/extended monitor.
- Do not ever disjoint this product. It may cause electrocution accident when touching high-voltage circuit inside this product.
- Outside power authorizing this product must be confirmed of product description and use rated voltage.
  - Beware that if higher voltage is authorized, unfixable damage might be caused due to product destruction.
- Power must be connected to domestic voltage (product rated voltage) consent or interior wiring.
  - If connected to other motive power or inverter-type power, product destruction, noise mixing, and picture distortion may occur.
- Do not drop this product. Glass is used for monitor and might break, or cause other circuit inferiority.
- In such case, immediately turn down the power switch, and call to consult agency or store in which this product was purchased.
- Keep away from any conditions where water splatters or falls. Do not place anything containing water like a vase on the product.
- If installed near transmission antenna such as broadcasting station, electric wave may mix and cause picture distortion or voice mixing.
- Avoid installing near tools with strong electromagnetic waves such as microwaves and cell phones, or it may cause picture distortion.
- Do not install monitor in following places.
  - ① Above or around water heater, rice-cooker, heater
  - ② Place exposed to direct rays of the sun
  - ③ Place with temperature below 0°C such as cold store
  - ④ Place with high humidity such as bathroom, washroom, heated room
  - ⑤ Place with a lot of gas, dust, smoke
  - ⑥ Dangerous place with sprays of water or chemicals
- Do not wipe with insecticide, drugs or chemicals such as thinner and alcohol, or it may damage the surface of this product.
- Beware of occurrence of image quality deterioration or malfunction from cause of humidity due to penetration of chemicals or water into camera's urea resins.
- As in the picture, it prevents temperature difference of camera (outside) and monitor (inside), and removes dew condensation caused by humidity of camera window.
- Camera must be installed when wall cement is completely dry.
- When product is installed in winter below -5°C, wait for approximately 2 hours to connect. Dew formation in monitor and camera due to temperature difference inside and outside may cause product defect.
- Avoid installing monitor and camera in place directly exposed to heat or where gas noxiousness is highly occurring.

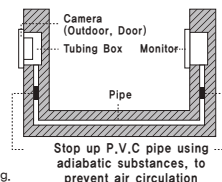

## Installation location

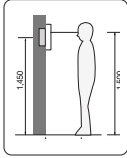

### ■ Monitor installation location

- Standard monitor installation height is about 1,500mm where screen center is at eye level.
- In this case, wall-hanging metal center (center of piping) is 1,450mm above ground level.
- Standard installation height

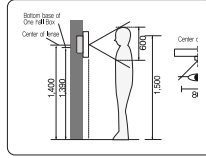

### ■ Camera installation location

- Camera installation in height Standard camera installation height is when lens is about 1,400mm above the floor.
- In this case, camera stack center (piping box) is above 1,390mm above ground level.
- Standard installation in height

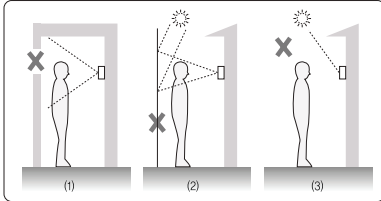

### ■ Caution of camera Installation

- Avoid installing camera exposed to direct ray of light (and sun).
- Beware backlight and darkness of visitor's face, which makes identification difficult.
- Avoid installing camera in places such as the following picture.
  - Place illuminating sky as background
  - Place with white wall reflecting direct ray of light
  - Place with direct ray of light
- Standard installation in height

## ■ Monitor Installation

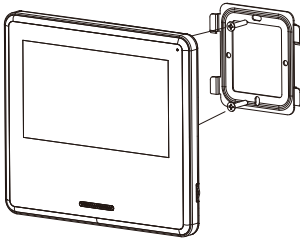

### ■ Directly connecting cut-off power cord with power wire

- Do not do such electric work on your own. Installing product in this way requires reliance on electric installation man with electric work license.
- Insulate with insulating tape while cutting off power cord and connecting with power wire so electric wire metal does not expose. Contact between exposed electric wires cause fire or electric shock accident.
- Such electric work requires connection after interception of supplied power.

- Remove wall hanger frame metal behind monitor.
- Install wall hanger frame metal on 1 type box or wall with attached Vis.
- Connect wiring to monitor back terminal referring to product connection diagram.
- Hang monitor on metal wall hanger frame and fix monitor on metal wall hanger frame
- Plug monitor's power plug into consent and check to see if the power switch is [ON] on the left side of monitor.

## ■ Door camera Installation

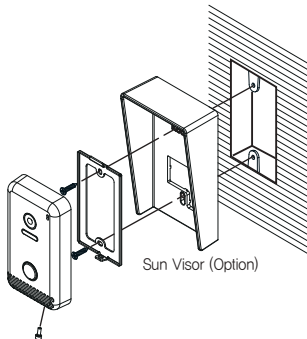

- Install metal wall hanger frame on 1 type box or on the wall with attached screws.
- Connect wiring to terminal on the back of door camera referring to product connection diagram.
- Hang door camera on metal wall hanger frame and fix door camera on metal wall hanger frame using attached screw.

Avoid heavy rain directed to the product which can cause damage since it is not waterproof.

## Components of Product

### ■ Monitor



### ■ A Wall Hanger Frame



### ■ Screws



### ■ Wire

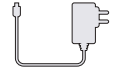
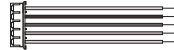
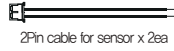
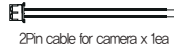

(Only included for DC type)

### ■ Door Camera

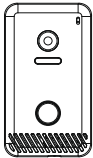

### ■ A Wall hanger frame



### ■ Wire

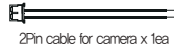

### ■ Sun Visor (Option)

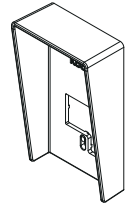

### ■ Screws



Screws for fixing main body on the wall



Screws for fixing Hanger frame body on the wall



## Specifications

|                       | Model No.             | KCV-S701P2W DC type                   | KCV-S701P2W AC type |
|-----------------------|-----------------------|---------------------------------------|---------------------|
|                       | Monitor               | Power Source                          | DC 18V ±2V 1A       |
| Power Consumption     |                       | 3W(±20%)(Stand by), 7W(±20%)(In load) |                     |
| Operating Temperature |                       | 0°C ~ +40°C                           |                     |
| LCD                   |                       | 7" color LCD                          |                     |
| Communication System  |                       | Handsfree Type                        |                     |
| WIFI                  |                       | IEEE 802.11 g/n                       |                     |
| Wiring                |                       | Door camera : 2 wire (Non Polarized)  |                     |
| Mount Type            |                       | Surface mount                         |                     |
| Dimension(mm)         |                       | 197(W) x 176(H) x 23(D) mm            |                     |
| Door Camera           | Model No.             | KC-S81MIP                             |                     |
|                       | Power Source          | DC 27±2V (Power from Monitor)         |                     |
|                       | Power Consumption     | Max. 3W                               |                     |
|                       | Operating Temperature | -10°C ~ +50°C                         |                     |
|                       | Dimension             | 70(W) x 125(H) x 21(D) mm             |                     |
|                       | Angle of Lens         | Diagonal 110 °                        |                     |

# Name and Functions of Each Part

## Monitor

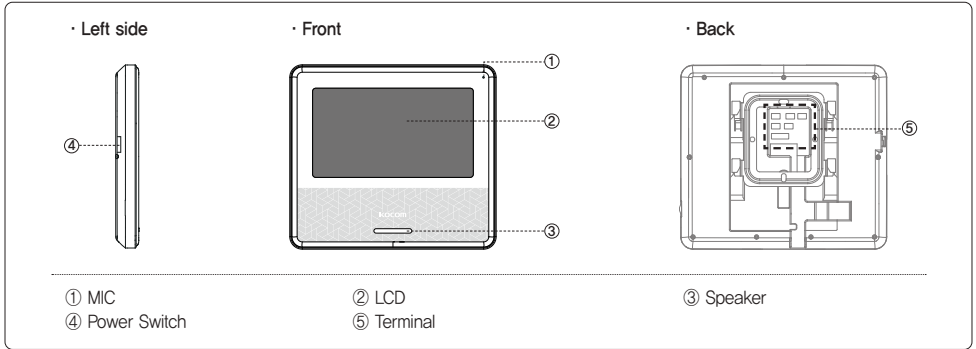

## Door camera (KC-S81MIP)

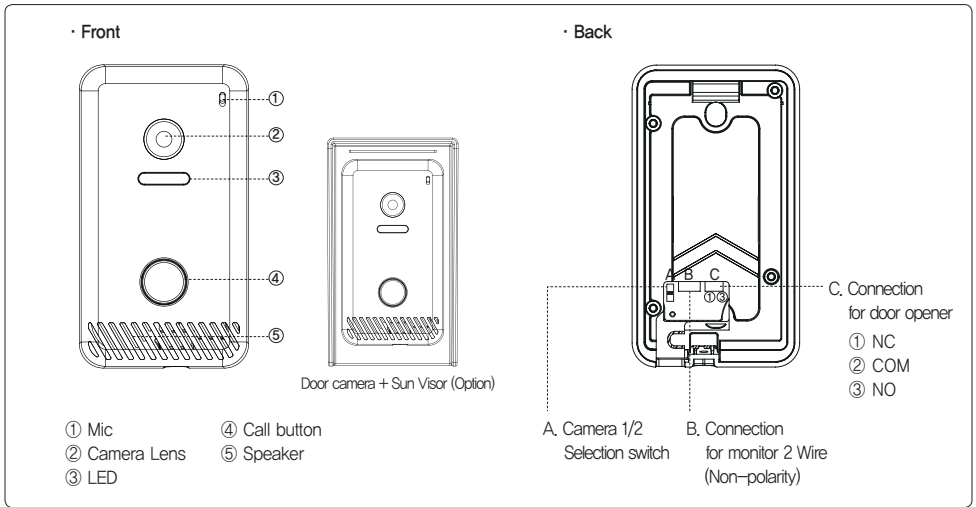

## Terminal

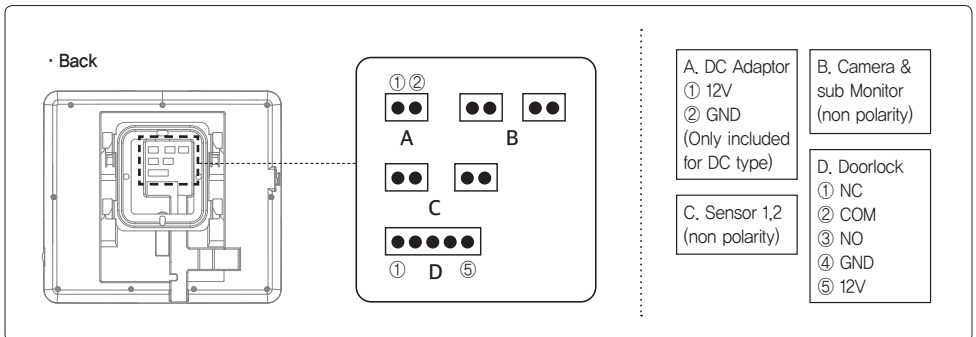

# Product Connection Diagram

## ■ SYSTEM Block Diagram

· 2 Camera / 4 Monitor

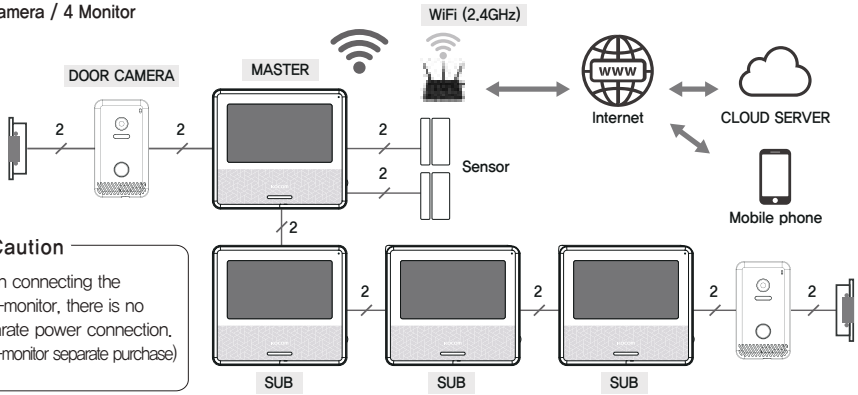

### ※ Caution

When connecting the Sub-monitor, there is no separate power connection. (sub-monitor separate purchase)

· 2 Camera / 1 Monitor

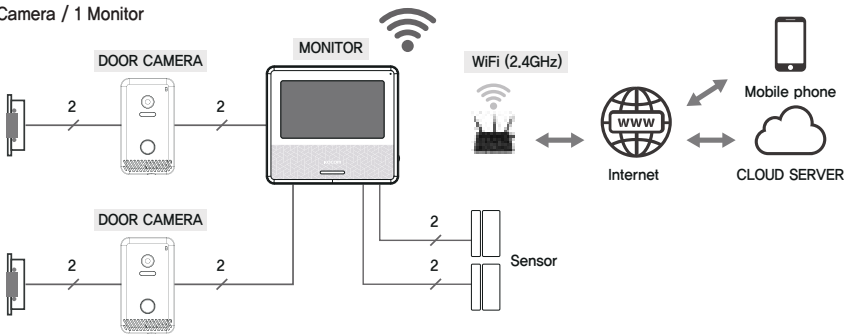

## ■ Wiring Specifications – Wiring distance from Camera to Monitor

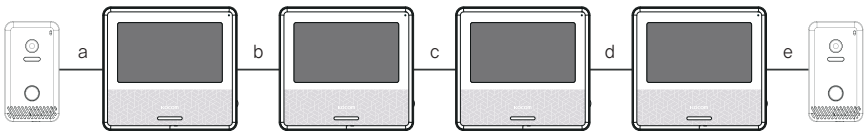

※ In case of using CAT 5 wiring as the picture below, the total distance of wiring (a,b,c,d,e) will be limited to 150m.

### UTP 1 Pair DC loop resistance measurement

Resistance measurement with a tester  
 $0,188\Omega/M \times 50M = 9,4\Omega$  below

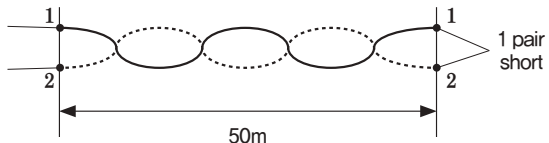

※ The conditions of installation may cause the poor quality of the image.

## ■ Booting



Booting Screen



Home Screen

Booting Screen is shown when you turn on Power Switch located on the left.  
After 15 seconds, and then booting is completed. After that, screen is home screen.

## ■ Home Screen UI

- Home screen is the start screen where all functions of the product can be run.
- Press menu icon in Home screen to run desired functions.



- ① Menu setting
- ② Display device number
- ③ Monitoring button
- ④ Internal call button
- ⑤ Button for viewing the screen capture images
- ⑥ Button to function all of the calling melody in silence
- ⑦ Button for outgoing (Select sensor activation mode)  
(This makes auto screen capture when calling from outdoor or interphone)



## ■ Setting Menu Screen



### ① General setting



- Device ID** : Setting monitor's ID.
- APP** : Smartphone APP connection settings.
- Time Setting** : System time setting.
- Date Setting** : System date setting.
- Language** : System language setting.

### ② Sound setting



- Sound Item** : Camera 1, Camera 2, Device
- Calling Volume** : 1 ~ 6
- Calling Melody** : 1 ~ 6
- Talk Volume** : 1 ~ 6
- Speaker Sensitivity** : 1~2 (Highly recommend to use in default)
- MIC Sensitivity** : 1~2 (Highly recommend to use in default)

### ③ Network setting



- WiFi** : WiFi On / Off
- Add network** : Connecting to WiFi manually.



Enter the WiFi password.

## ■ Setting Menu Screen

### ④ Mode setting



**Auto Image Capture** : When you select "ON", automatic screen capture available as per visitor's call.

**Always On Display** : When "ON" is selected, the clock always appears. (User mode: OFF)

**Absent Setting Time** : You can select 15 sec, 30 sec, 45 sec, or 60 sec.

**Monitoring Time** : You can select 30 sec, 60 sec, 120 sec, or 180 sec.

**Door Open Time** : You can select 0,2sec, 1~9sec.

### ⑤ Other setting



**Screen Brightness** : You can adjust the brightness of the display.

**Modify PIN** : Enter the PIN number to release the crime prevention sensor after operation.

**System Information** : Display information about the current device.

**Manual Download** : Display QR code that connects to the manual to be shown in your mobile phone.

PIN password change (Default Password : 0000)

※ Caution : You must know the changed PIN number.

※ The password can be up to eight digits.

### ⑥ Reset

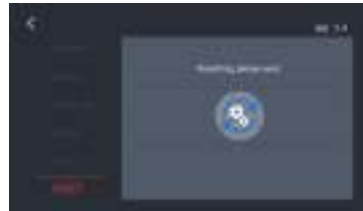
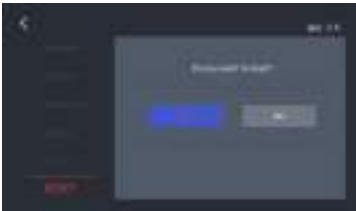

When you select "Yes", then factory mode will be activated, (Except selected language)

## Instructions for Operation

### ■ Network Setting (Monitor)

– Configuration needs to be done for WiFi connection to "KCV-S701P2W".

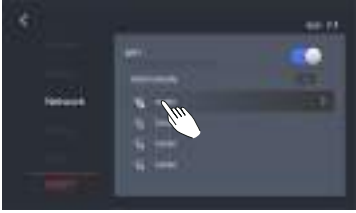

Press WiFi router selection.



Input WiFi SSID and password.



WiFi Connection successfully done.



Icon showing WiFi normal connection is seen when pushing menu button and going into menu screen.

### ■ App download, Specification of Smart Phone and Network

Search "KOCOM Home" in Play Store(Android) or App Store(iOS).

| Item                                | Description  |
|-------------------------------------|--|
| Recommended Spec of Smart Phone     | Android 8.0 version or higher.<br>iOS 11.4 version or higher.  |
| Recommended Spec of Wireless Router | Wireless router using only 2.4G<br>– Wireless router using 2.4G and 5G may not interwork.<br>– IEEE 802.11 g/n   |
| Recommended Network Delay Time      | KCV-S701P2W (←) AP within 50m sec<br>KCV-S701P2W (←) CLOUD within 100m sec<br>– In case that delay time of network exceeds the abovementioned, it may not interwork.<br>– It may not interwork depending upon the status of 3G, LTE and telecom. |
| Recommended Network data rates      | 20Mbps<br>Depending on network transmission speed and condition, the video or voice would be disconnected  |

### ■ Network Setting (Smart Phone)

– Please proceed the following steps when the KCV-S701IP2W monitor's menu screen is on. While proceeding the registration steps, please click the menu button to keep the screen on.



The "APP" button must be activated in the General setting.



When you select the QR code, the QR code for downloading 'KOCOM Home APP' appears.

- ※ To set WiFi mode of wireless AP at KCV-S701IP2W, you must install APP called "KOCOM HOME" to your Android Phone / iPhone.  
Please scan APP QR code on page 1 of this manual. Or you can download by following procedures.  
Android : Google playstore > KOCOM Home, iOS : Appstore > KOCOM Home

## ■ Network Setting (Smart Phone)

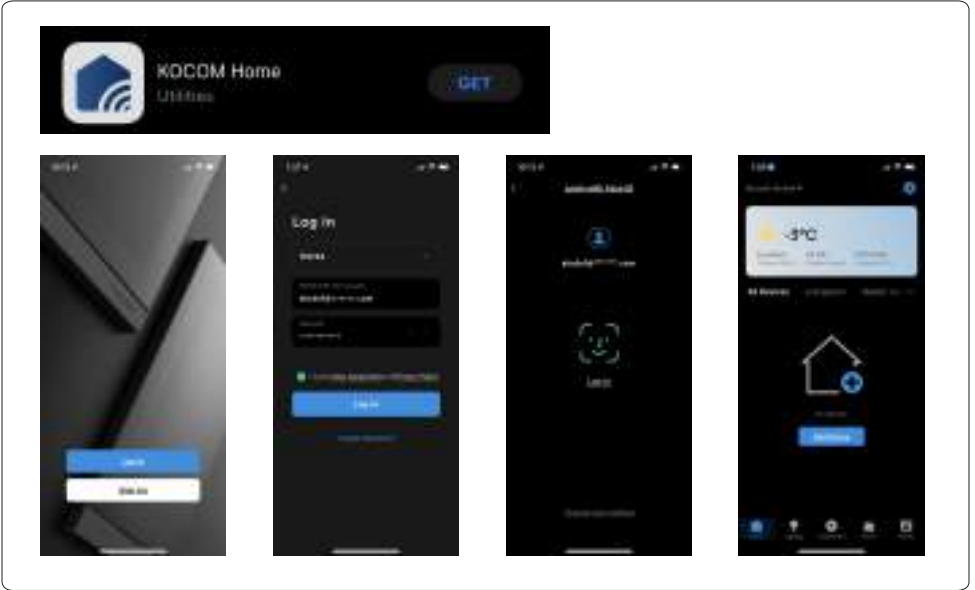

## ■ How to Register 'KCV-S701P2W' into Smart Phone

- To get visitor's calling through your phone, you must register 'KCV-S701P2W' to your smartphone.
- Only one smartphone is registered on the video phone, and additional users can register as family members through the app and use the same.



Start KOCOM Home APP pressing '+' (Add device).

'KCV-S701P2W' is recognized automatically and press 'Add'.

Device is registered.

Main screen after registration.

※ To register a videophone in the 'KOCOM HOME' app, your smartphone must be connected to the same Wi-Fi router.

## Instructions for Operation

### ■ Call in KOCOM Home APP

① Image of visitor  
② Name of current device (Videophone set)  
③ End of call  
④ Call connection  
⑤ Voice call with visitor / End

When your phone registration to KCV-S701P2W is done, you can open the door or perform visual communication with visitors through your phone's APP.

※ NOTICE : Depending on network transmission speed and condition, the video or voice could be disconnected.

### ■ Door open in KOCOM Home APP

To check more menu, press '☰' button.

Activate the door open button pressing '●'.

Tap the key shape icon.

Press "Confirm" to approve the door opening.

## How to Operate

### ■ Calling from Outdoor Camera

– When calling from the outdoor camera, you can see the image of visitors, make a call, and open the door.

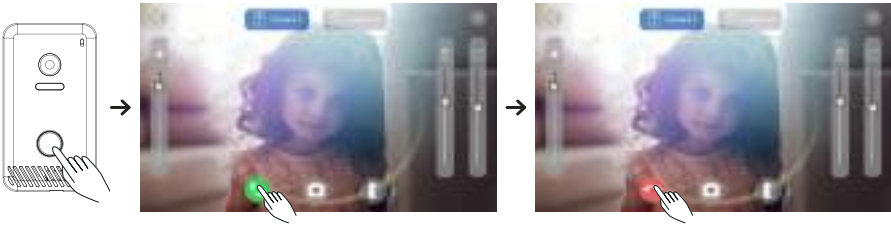

Press the call button to make a call.

When calling to the monitor, you will see visitor's image. Press call button, then calling with visitor can be functioned.

After pressing door open button, door opens right away. After door opening, calling will be automatically off after 5 secs.

(Calling time : 30 secs)

When pressing END button while talking with visitors, calling will be off.

Press door open button then you can open the door.

(Talking time : 180 secs)

(Door opening time : Default 0,2 seconds, you can change at the "Settings")

#### ※ Caution

In case of extended monitors, all of the devices will receive at once when calling from the outdoor camera. If one device gets connected, the rest will be automatically off.

### ■ About Call Screen Icon (UI Function Buttons)



- ① Home button
- ② Camera button : Connected camera
- ③ Camera Button : Not connected
- ④ Time
- ⑤ Brightness control bar
- ⑥ Call button : Receive call
- ⑦ Capture button : Screen capture and save
- ⑧ Door open button : Door gets opened
- ⑨ Camera melody sound volume control bar
- ⑩ Monitor melody sound volume control bar



- ① End button : End of the call
- ② Camera calling voice volume control bar
- ③ Monitor calling voice volume control bar

※ While the image of 'Camera 1' is on, press 'Camera 2' then you see the other image.

※ Touch the screen once on the camera screen to display a bar that can adjust the brightness and volume of the screen.

## How to Operate

### ■ Extension Calling & Receiving Function

- In case of extended monitors, you can perform extension calling.  
To perform extension calling, you MUST set each device's numbering at the "Setting"  
From ID #1 to #4 is available to register, you MUST register in order.



When pressing extension call button, the menu for extension call will be displayed. Device number is automatically shown if there's a same device number already, 'ID Collision' will be shown at 'Device 1'

Whole devices calling or each calling is available at this stage. When pressing a device button, that device calling will be in operation. While calling, icon will be changed. When pressing "Home icon" at 'Home', call will be cancelled.

When calling the whole devices, all will be rung. (Extension calling time : 30 secs)

When the connection with calling device is made, calling icon will be changed into extension calling icon. By pressing home icon, calling will be off. When touching other buttons in the middle of the described function hereby, you will hear BUZZ sound to alarm you. When only one device is connected while calling the whole devices, the rest will be automatically off. (Extension talk time : 180 secs)

### ■ Receiving from the Other Monitor



When extension calling from other monitors, extension calling melody will be rung. Calling devices icon will be changed to calling icon. Press calling icon then calling gets connected. When touching other buttons in the middle of the described function hereby, you will hear BUZZ sound to alarm you. (Extension calling time : 30 secs)

Extension calling icon is shown. Press home button and calling will be off. When touching other buttons in the middle of the described function hereby, you will hear BUZZ sound to alarm you. (Extension talk time : 180 secs)

The icon when there's no device connected.

### ■ Absent Mode Function



· When pressing absent mode button, the screen for sensor button will be displayed. (Sensor : Magnet sensor)

· Select and activate the sensor button associated with the product, then press the start button. Absent mode is started according to the set time.

· Enter the password to release the crime prevention sensor after operation. (The initial password is set to '0000')

※ After setting the absent mode, you must first release the absent mode to prevent an emergency alarm sound.





## ■ To View Screen Captured Images





Press image view button at the home screen, then the screen for captured images lists will be displayed, 'N' icon at means the recent images are being saved, Maximum 50 images can be stored, Images will be deleted from the oldest and then recent one gets saved.



Click the image and the selected will be displayed. Press , you will delete the selected image. Press , you will delete the whole listed images.



At the image view screen, you can see stored images. Press left or right arrow button, then you can see other images. Press delete button and deletion can be made right away . Press home button at  and the image lists will be displayed.



Available to check other images with the left and right arrow keys.

## ■ QR Code for Manual



QR code to download the manual appears after tapping  button on 'Other setting' screen.



Scan the QR code to check the manual.





## Warranty

▶ To receive after service, have the following ready before you contact our branches.

1. Name of the product.
2. Model number of the product.
3. The area of problem.
4. Phone number and address at which you can be contacted.

## Warranty Card

|                 |              |
|-----------------|--------------|
| PRODUCT         |              |
| MODEL           | KCV-S701IP2W |
| DATE PURCHASED  |              |
| WARRANTY PERIOD |              |
| AGENCY ADDRESS  |              |

▶ KOCOM Warranties the original purchaser of this product as follows.

- 1) This product is produced under strict quality control and inspection procedures.
- 2) If this product breaks down during proper use as a result of product defect, KOCOM will repair it within one year from date of purchase free of charge.
- 3) The following cases will be subject to charge, even during warranty period:
  - a. Breakdown during transport, or through careless treatment, by consumer.
  - b. Breakdown cause by unauthorized repair, or system modification.
  - c. Breakdown caused by natural disaster or power disorder.

▶ Note: This equipment has been tested and found to comply with the limits for a Class B digital device, pursuant to part 15 of the FCC Rules. These limits are designed to provide reasonable protection against harmful interference in a residential installation. This equipment generates, uses and can radiate radio frequency energy and, if not installed and used in accordance with the instructions, may cause harmful interference to radio communications. However, there is no guarantee that interference will not occur in a particular installation. If this equipment does cause harmful interference to radio or television reception, which can be determined by turning the equipment off and on, the user is encouraged to try to correct the interference by one or more of the following measures:

- Reorient or relocate the receiving antenna.
- Increase the separation between the equipment and receiver.
- Connect the equipment into an outlet on a circuit different from that to which the receiver is connected.
- Consult the dealer or an experienced radio/TV technician for help.

