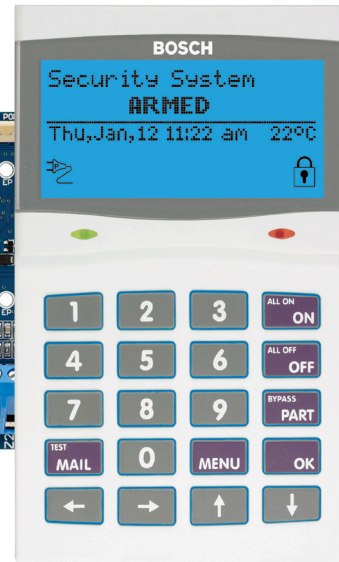
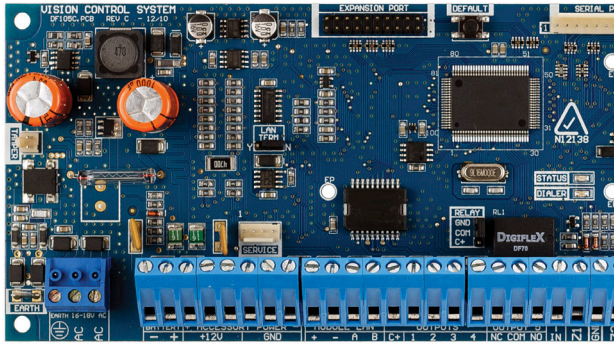


# Solution 144



Security Systems

EN

Installation Manual  
Security System

**BOSCH**

**COPYRIGHT NOTICE**

Unless otherwise indicated, this publication is the copyright of Bosch Security Systems Pty Ltd (“Bosch”). All rights are reserved. You may download a single copy of this publication. By downloading the publication you agree that you will: (i) only use the publication for your own reference; (ii) not commercially exploit or charge any person for the use of the publication; and (iii) not modify the publication in any way without the prior written permission of Bosch. Except as specified above or where authorised by the Copyright Act 1968 (Cth), no part of this publication may be reproduced, transmitted, modified or stored in any form or by any means, without the prior written permission of Bosch.

**TRADEMARKS**

Throughout this document trademark names may have been used. Rather than put a trademark symbol in every occurrence of a trademark name, we state that we are using the names only in an editorial fashion and to the benefit of the trademark owner with no intention of infringement of the trademark.

**NOTICE OF LIABILITY**

While every effort has been taken the accuracy of this document, neither Bosch Security Systems Pty Ltd nor any of its official representatives shall have any liability to any person or entity with respect to any liability, loss or damage caused or alleged to be caused directly or indirectly by the information contained in this book. Should you find any error or inconsistency, please notify us accordingly.

Bosch Security Systems Pty Ltd reserves the right to make changes to features and specifications at any time without prior notification in the interest of ongoing product development and improvement.

**TELEPERMIT NOTE**

The grant of a Telepermit for a device in no way indicates Telecom acceptance of responsibility for the correct operation of that device under all operating conditions.

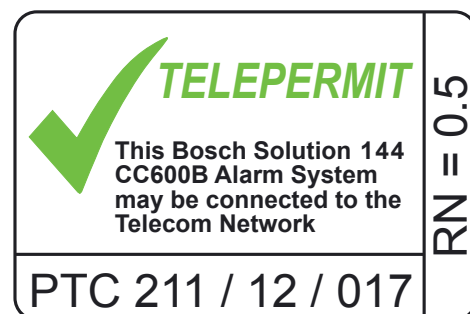
This equipment shall not be used in any manner that could constitute a nuisance to other Telecom customers.

Immediately disconnect this equipment should it become physically damaged, and arrange for its disposal or repair.

The transmit level from this device is set as a fixed level and because of this there may be circumstances where the performance is less than optimal. Before reporting such occurrences as faults, please check the line with a standard telepermitted telephone.

**Warnings**

- 1) This product must be installed by a qualified and licensed security installer.
- 2) This product may not perform as expected if installed incorrectly.
- 3) Some features of this product, including but not limited to Back to Base reporting, SMS and Email Reporting and Automatic Time and Date Adjustments require a working telephone line to operate and telephone communication service provider charges are applicable
- 4) Australian standard AS 2201 requires regular service by qualified and licensed security persons and regular user testing. Please consult your security alarm company for further details.
- 5) Incorrect programming of parameters can result in operation contrary to what may be desired.
- 6) Leave the mains adapter plugged in at all times.
- 7) Leave the telephone line plugged in at all times under normal conditions.
- 8) The Product Identification Label for this product which is supplied in the resistor pack, must be affixed to the outside of the enclosure during installation.



- 9) This equipment shall not be set up to make automatic calls to the Telecom '111' Emergency Service.

# CONTENTS

COPYRIGHT NOTICE .....	II
TRADEMARKS .....	II
NOTICE OF LIABILITY .....	II
TELEPERMIT NOTE .....	II
<b>SECTION 1</b>	
<hr/>	
<b>OVERVIEW .....</b>	<b>1-1</b>
FEATURES .....	1-1
OVERVIEW .....	1-1
<b>SECTION 2</b>	
<hr/>	
<b>INSTALLING THE HARDWARE .....</b>	<b>2-1</b>
ABOUT THE PANEL .....	2-1
ENCLOSURES .....	2-1
ENCLOSURE FIXING METHOD .....	2-1
INSTALLING THE TAMPER SWITCH .....	2-1
ENCLOSURE MODULE SPACES .....	2-1
INSTALLING PANELS AND MODULES .....	2-2
CONNECTING POWER TO THE PANEL .....	2-4
CONNECTING THE BATTERY .....	2-4
AC MAINS TRANSFORMER OPTION .....	2-4
PANEL LED INDICATORS .....	2-5
ABOUT THE KEYPAD .....	2-5
STATUS ICONS / LED'S .....	2-6
KEYPAD TONES .....	2-6
KEYPAD & READERS SETUP .....	2-7
DIP SWITCH ADDRESS SELECT .....	2-7
ROTARY SWITCH ADDRESS SELECT .....	2-7
EOL RESISTOR COLOUR CODE .....	2-8
<b>SECTION 3</b>	
<hr/>	
<b>WIRING DIAGRAMS .....</b>	<b>3-1</b>
ZONE WIRING .....	3-1
EOL RESISTOR COLOURS AND VALUES .....	3-2
BOARD CONNECTORS .....	3-2
TERMINAL DESCRIPTIONS .....	3-2
LAN OVERVIEW .....	3-3
LAN WIRING .....	3-3
SYSTEM EARTHING .....	3-4
TERMINATING THE LAN .....	3-4
<b>SECTION 4</b>	
<hr/>	
<b>PROGRAMMING OVERVIEW .....</b>	<b>4-1</b>
ENTERING PROGRAMMING MODE .....	4-1
EXITING PROGRAMMING MODE .....	4-1
COMMAND MENUS .....	4-1
PROGRAMMING OPTION BIT MENUS .....	4-1
NAVIGATING THE MENUS .....	4-1
LIST OPTIONS .....	4-1
ALPHA TEXT .....	4-2
CLOCK PROGRAMMING .....	4-2
TELEPHONE NUMBERS .....	4-2
GETTING STARTED BACK TO BASE .....	4-2

<b>SERVICE MODE .....</b>	<b>4-3</b>
Turning Service Mode ON .....	4-3
Turning Service Mode OFF .....	4-3
<b>DEFAULTING THE SYSTEM .....</b>	<b>4-3</b>
Hardware Default.....	4-3
Software Default .....	4-3
<b>TRIGGERING A DURESS ALARM .....</b>	<b>4-3</b>
<b>DOMESTIC TEMPLATE DEFAULTS .....</b>	<b>4-3</b>
<b>DIRECT LINK PROGRAMMING .....</b>	<b>4-3</b>
<b>ZONE ARRAY .....</b>	<b>4-4</b>
<b>OUTPUT ARRAY .....</b>	<b>4-4</b>
<b>DOOR ARRAY .....</b>	<b>4-4</b>
<b>TESTING THE SYSTEM .....</b>	<b>4-4</b>
<b>BASIC REPORTING REFERENCE .....</b>	<b>4-5</b>
<b>DTMF CONTROL FUNCTIONS .....</b>	<b>4-6</b>
<b>MENU REFERENCE TABLE .....</b>	<b>4-7</b>
<b>BASIC SYSTEM OPERATION .....</b>	<b>4-10</b>
<b>TURNING AN AREA ALL ON .....</b>	<b>4-10</b>
<b>TURNING AN AREA PART ON / PART 2 ON .....</b>	<b>4-10</b>
<b>TURNING AN AREA OFF .....</b>	<b>4-10</b>
<b>SILENCING ALARMS.....</b>	<b>4-10</b>
<b>AUTOMATIC ARMING.....</b>	<b>4-10</b>
<b>REMOTE ARMING - QUICK ARM.....</b>	<b>4-11</b>
<b>DURESS OR SILENT ALARMS.....</b>	<b>4-11</b>
 <b>SECTION 5</b>	
<b>ACCESS PROGRAMMING.....</b>	<b>5-1</b>
<b>USER DEFAULT TABLE .....</b>	<b>5-2</b>
<b>USER PINS .....</b>	<b>5-2</b>
Erase User.....	5-2
Change Own PIN.....	5-3
Change Other PIN.....	5-3
Add PIN.....	5-4
Delete PIN .....	5-4
View PIN .....	5-4
<b>USER TOKENS .....</b>	<b>5-4</b>
Add Token .....	5-4
Delete Token.....	5-5
Token Status .....	5-5
Edit Token.....	5-5
<b>RF KEYFOBS .....</b>	<b>5-6</b>
Add Keyfob .....	5-6
Delete Keyfob.....	5-6
Test Keyfob .....	5-6
<b>USER PROPERTIES.....</b>	<b>5-7</b>
User Name.....	5-7
Area Assignment .....	5-7
User Options.....	5-8
Master User .....	5-8
Arm Only .....	5-8
Can Bypass .....	5-8
Auto Bypass Allowed.....	5-8
Always Report Op/Cl .....	5-8
<b>UNDERSTANDING TIMEZONES .....</b>	<b>5-8</b>
User .....	5-8
TimeZones.....	5-8
TimeZone Access Example.....	5-8
TimeZone Access .....	5-9
Door Assignment.....	5-9
User Expire Date .....	5-10
PIN Length .....	5-10

PIN Retry Count.....	5-10
Installer PIN .....	5-11
Access Route.....	5-11
Access Options .....	5-11
Add Fingerprint .....	5-12
Delete Fingerprint.....	5-12
Fingerprint Status.....	5-12

## SECTION 6

<b>AREA PROGRAMMING.....</b>	<b>6-1</b>
<b>AREA COMMANDS .....</b>	<b>6-1</b>
Area Status.....	6-1
Turn Area On/Off .....	6-2
Turn All Areas On .....	6-2
Turn All Areas Off.....	6-2
Move To Area .....	6-2
Chime On/Off .....	6-2
Chime Mode .....	6-3
<b>AREA PROPERTIES .....</b>	<b>6-3</b>
Area Name .....	6-3
<b>General Options.....</b>	<b>6-3</b>
Exit Time Restart.....	6-4
Reset Alarm Memory.....	6-4
Duress Allowed.....	6-4
Fault ACK Required.....	6-4
One Key Arming .....	6-4
One Key Part On .....	6-4
Link To Common Area.....	6-4
One Key Part Off.....	6-4
<b>Input Options .....</b>	<b>6-4</b>
Non Sequential.....	6-4
Pulse Count H/Over .....	6-4
Senior Watch.....	6-5
<b>Output Options.....</b>	<b>6-5</b>
SPK Beeps Keyfob .....	6-5
SPK Beeps Key/Sw .....	6-5
SPK Strobe In Part On.....	6-5
Alarm On PIN Retry .....	6-5
Alarm Exit Error.....	6-5
Alarm Key/Sw Tamper.....	6-5
<b>Reporting Options.....</b>	<b>6-5</b>
Report PIN Retry.....	6-6
Report Exit Error .....	6-6
Smart Lockout.....	6-6
Cancel Report.....	6-6
Op/Cl In Part On .....	6-6
Op/Cl After Alarm .....	6-6
<b>Strobe Trigger .....</b>	<b>6-6</b>
Audible Burglary .....	6-6
Silent Burglary.....	6-6
Fire Alarm.....	6-6
Keyfob On/Off.....	6-6
Keyswitch On/Off.....	6-7
24Hr Alarm .....	6-7
Part Mode 1 Name .....	6-7
Part Mode 2 Name .....	6-7
Auto Arming .....	6-7
<b>AREA REPORTING.....</b>	<b>6-8</b>
Account Dest 1 .....	6-8
Account Dest 2 .....	6-8
Open Close Route.....	6-8
<b>AREAS TIMERS .....</b>	<b>6-8</b>
Exit Time .....	6-8
Entry Time 1 .....	6-9
Entry Time 2.....	6-9

Part Entry Time.....	6-9
Auto Arm Pre-Alert.....	6-10
Senior Watch Time.....	6-10
<b>AREA TESTING .....</b>	<b>6-11</b>
Area Watch.....	6-11
User Test Interval .....	6-11
Service Interval .....	6-11
Test Options.....	6-12
User Test Required.....	6-12
Walk Test Report.....	6-12
Walk Test 24Hr.....	6-12
Walk Test Fire .....	6-12

## **SECTION 7**

<b>INPUT PROGRAMMING .....</b>	<b>7-1</b>
<b>ZONE ASSIGNMENTS .....</b>	<b>7-1</b>
<b>INPUT COMMANDS .....</b>	<b>7-2</b>
Zone Status.....	7-2
Zone Array .....	7-2
Bypass Zones.....	7-2
Set Chime Zones .....	7-3
Set Part 2 Zones .....	7-3
Smoke Sensor Reset.....	7-4
<b>ZONE PROPERTIES .....</b>	<b>7-4</b>
Zone Name.....	7-4
<b>ZONE DEFAULT TABLE.....</b>	<b>7-4</b>
Zone Type.....	7-5
00 – Not Used.....	7-5
01 – Burglary Delay 1 .....	7-5
02 – Burglary Delay 2.....	7-5
03 – Burglary Instant.....	7-5
04 – Burg Inst No Exit .....	7-5
05 – Burglary Handover.....	7-5
06 – Burglary 24Hr.....	7-5
07 – Tamper 24Hr.....	7-5
08 – Hold Up 24Hr.....	7-5
09 – Medical 24Hr .....	7-5
10 – Panic 24Hr.....	7-6
11 – Fire 24Hr .....	7-6
13 – Keyswitch Zone.....	7-6
14 – Display Only .....	7-6
15 – Non Burglary 24Hr .....	7-6
Area Assignment .....	7-6
Pulse Count.....	7-7
Pulse Count Time .....	7-8
<b>UNDERSTANDING ACCESS GROUPS .....</b>	<b>7-8</b>
Users.....	7-8
Outputs .....	7-8
Reader .....	7-8
Access Group.....	7-8
<b>Door Access Group Example .....</b>	<b>7-8</b>
<b>Door Assignment.....</b>	<b>7-9</b>
<b>Report Route .....</b>	<b>7-9</b>
<b>Report Options .....</b>	<b>7-9</b>
Lockout Dialler.....	7-9
Report Alarm .....	7-10
Report Troubles .....	7-10
Report Bypass .....	7-10
Report Restores .....	7-10
Delay Reporting .....	7-10
<b>Zone Options.....</b>	<b>7-10</b>
Lockout Siren.....	7-10
Silent Alarm.....	7-10
Inverted Seal.....	7-10

Bypass Allowed.....	7-11
Sensor Watch.....	7-11
Armed In Part On.....	7-11
No EOL Required.....	7-11
Test On Exit.....	7-11
<b>ADDING RF SENSORS.....</b>	<b>7-11</b>
Add RF Device .....	7-11
Delete RF Device.....	7-12
Test RF Device.....	7-12
<b>GLOBAL INPUT OPTIONS .....</b>	<b>7-12</b>
EOL Value .....	7-12
Keyswitch Options.....	7-12
Input Options .....	7-13
Tamper On Short.....	7-13
Response Time 500msec.....	7-13
Keyswitch Open Close.....	7-13
Alarm On Tamper.....	7-13
Input Type .....	7-13
Tamper Options .....	7-14
Display Cabinet Tpr .....	7-14
Report Cabinet Tpr .....	7-14
Audible Cabinet Tpr .....	7-14
Display Expander Tpr.....	7-14
Report Expander Tpr.....	7-14
Audible Expander Tpr.....	7-14
<b>INPUT TESTING.....</b>	<b>7-14</b>
Walk Test All Zones.....	7-14
Walk Test A Zone.....	7-14
Sensor Watch Time .....	7-15

## SECTION 8

<b>OUTPUT PROGRAMMING .....</b>	<b>8-1</b>
<b>OUTPUT COMMANDS .....</b>	<b>8-1</b>
Output Status.....	8-1
Turn Output On/Off.....	8-2
Output Array.....	8-2
Door Status .....	8-2
Door Array.....	8-3
Door Override .....	8-3
<b>OUTPUT PROPERTIES .....</b>	<b>8-4</b>
Output Name.....	8-4
Event Type.....	8-4
01 - Battery Trouble.....	8-4
02 - AC Trouble.....	8-4
03 - Telco Line Fail.....	8-4
04 - Comm Fail .....	8-4
05 - 3rd Dial Attempt.....	8-4
06 - Dest Reporting.....	8-4
07 - Reserved .....	8-4
08 - Dest Kiss Off .....	8-4
09 - User Keyfob Func 1 .....	8-4
10 - User Keyfob Func 2 .....	8-5
11 - Dialler Disabled.....	8-5
12 - Output Device Missing.....	8-5
13 - Output Trouble.....	8-5
14 - Panel On Line.....	8-5
15 - Incoming Call.....	8-5
16 - System Trouble.....	8-5
17 - Box Tamper .....	8-5
18 - Zone Trouble .....	8-5
19 - Zone Mirror.....	8-5
20 - Zone Alarm .....	8-5
21 - Area Disarmed.....	8-5

22 – Area Part Or All On .....	8-5
23 – Area All On .....	8-5
24 – Area Part On .....	8-5
25 – Area Part 2 On.....	8-5
26 – Entry Timing .....	8-6
27 – Exit Timing .....	8-6
28 – End Of Exit Time.....	8-6
29 – Chime On .....	8-6
30 - Chime Zone Trigger.....	8-6
31 – Auto Arm Pre Alert.....	8-6
32 – Ready To Arm All On.....	8-6
33 – Ready To Part Arm.....	8-6
34 – Ready To Part 2 Arm .....	8-6
35 – Close Sent OK.....	8-6
36 – External Audible .....	8-6
37 – Internal Audible .....	8-7
38 – Any Zone Alarm .....	8-7
39 – Fire Alarm .....	8-7
40 – Burglary Alarm .....	8-7
41 – Silent Alarm.....	8-7
42 – Duress Alarm.....	8-7
43 – Keypad Medical.....	8-7
44 – Keypad Fire .....	8-7
45 – Keypad Panic.....	8-7
46 – Device Tamper .....	8-7
47 – Access Denied .....	8-7
48 – Strobe .....	8-7
49 – Smoke Sensor GND.....	8-7
50 – Sensor Watch .....	8-7
51 – Senior Watch .....	8-7
52 – Exit Error .....	8-8
53 – Keyfob Function 1 .....	8-8
54 – Keyfob Function 2 .....	8-8
55 – Output In PreDelay .....	8-8
56 – Follow PIN Code.....	8-8
57 – Part Entry Time.....	8-8
58 – TimeZones.....	8-8
59 – Temperature Hi/Lo .....	8-8
60 – Door .....	8-8
61 - Door Open Too Long.....	8-8
71 - CLI Trigger .....	8-8
71 - GSM Signal Lost .....	8-8
73 - GPRS Failure .....	8-8
74 - Ethernet Fail .....	8-8
<b>Event Assignment.....</b>	<b>8-9</b>
<b>Output Polarity .....</b>	<b>8-9</b>
Open To Low.....	8-9
Open To Low + Pre .....	8-9
Open Latching Low.....	8-9
Open Pulsing Low.....	8-9
Open 1 Shot Low.....	8-10
1 Shot Low+Retrigger .....	8-10
1 Shot Low + Reset.....	8-10
Low To Open.....	8-10
Low To Open + Pre .....	8-10
Low Latching Open.....	8-10
Low Pulsing Open.....	8-10
Low 1 Shot Open.....	8-10
1 Shot Open+Retrigger .....	8-10
1 Shot Open + Reset.....	8-10
Speaker Output .....	8-10
Toggle .....	8-10
<b>TIMED OUTPUTS .....</b>	<b>8-10</b>
<b>Time Parameter.....</b>	<b>8-10</b>
One Shot Mode .....	8-11



Pulsing Mode.....	8-11
<b>Output Options.....</b>	<b>8-11</b>
Guest Control .....	8-11
Monitor Overload .....	8-11
Monitor Device Fail .....	8-11
Alarm On Device Fail .....	8-11
Block If All On .....	8-11
Show Status On Keypad .....	8-11
<b>Macro Group.....</b>	<b>8-11</b>
<b>Reserved.....</b>	<b>8-11</b>
<b>DOOR CONTROL .....</b>	<b>8-12</b>
Door Name.....	8-12
Unlock TimeZone.....	8-12
<b>Door Options .....</b>	<b>8-13</b>
Hold Off If Area Armed .....	8-13
Hold Off Auto Unlock .....	8-13
Report Door Forced .....	8-13
Alarm Door Forced.....	8-13
<b>OUTPUT TESTING .....</b>	<b>8-13</b>
External Siren Test .....	8-13
Internal Siren Test.....	8-14
Strobe Test .....	8-14
Fire Siren Test .....	8-14
<b>OUTPUT EVENT TYPE TABLE .....</b>	<b>8-15</b>
<b>OUTPUT ASSIGNMENTS .....</b>	<b>8-16</b>
<b>OUTPUT DEFAULT TABLE.....</b>	<b>8-16</b>

## SECTION 9

<b>COMMS PROGRAMMING .....</b>	<b>9-1</b>
<b>COMMS PROGRAMMING COMMANDS .....</b>	<b>9-1</b>
Call/Answer RAS .....	9-1
Call Forward On/Off .....	9-1
Check Web Email .....	9-2
Email System Log.....	9-2
Start Direct Link.....	9-2
Voice Setup .....	9-2
Register Customer .....	9-4
Comms > Commands > .....	9-4
Register Installer.....	9-4
<b>PHONE NUMBER PROGRAMMING .....</b>	<b>9-4</b>
Number Prefix .....	9-4
Destination 1 .....	9-4
Destination 2 .....	9-5
Call Forward On .....	9-5
Call Forward Off.....	9-6
<b>COMMS PROPERTIES .....</b>	<b>9-6</b>
Call Attempt Count.....	9-6
<b>Dialler Options .....</b>	<b>9-7</b>
Dialler Enabled.....	9-7
Pulse Dialling.....	9-7
Dial Tone Detect.....	9-7
Busy Tone Detect .....	9-7
Mirror Report WEB.....	9-7
Extend H/S To 1 min.....	9-7
Abort Failed Reports.....	9-7
<b>Phone Line Options.....</b>	<b>9-7</b>
Display Line Fail.....	9-7
Report Line Fail.....	9-7
Alarm L/Fail If On.....	9-8
Alarm L/Fail If Off .....	9-8
Display On Line.....	9-8
<b>Country.....</b>	<b>9-8</b>
Set SMS Password.....	9-9
Call Back Number .....	9-9

<b>RAS Security PIN</b> .....	<b>9-10</b>
<b>Log Threshold</b> .....	<b>9-10</b>
<b>Ring Count</b> .....	<b>9-10</b>
<b>RAS Options</b> .....	<b>9-10</b>
RAS Allowed .....	9-11
Callback Verify.....	9-11
Abort RAS On Alarm .....	9-11
Answering Bypass.....	9-11
Answer Only If Armed .....	9-11
Tone Bypass .....	9-11
Report RAS Sessions .....	9-11
<b>DTMF Options</b> .....	<b>9-11</b>
DTMF Arming .....	9-11
DTMF Disarming .....	9-11
DTMF User Functions .....	9-11
DTMF Quick Arming.....	9-11
<b>Voice Access Code</b> .....	<b>9-12</b>
<b>CLI Numbers</b> .....	<b>9-13</b>
<b>User RAS PIN</b> .....	<b>9-13</b>
<b>REPORTING OPTIONS</b> .....	<b>9-14</b>
<b>TX Format Dest 1</b> .....	<b>9-14</b>
<b>TX Format Dest 2</b> .....	<b>9-14</b>
<b>Test Route</b> .....	<b>9-14</b>
<b>System Route</b> .....	<b>9-14</b>
<b>Emergency Route</b> .....	<b>9-15</b>
<b>Swinger Dialler</b> .....	<b>9-15</b>
<b>Burg Report Delay</b> .....	<b>9-15</b>
<b>Fire Report Delay</b> .....	<b>9-15</b>
<b>MYALARM</b> .....	<b>9-16</b>
<b>IP Address</b> .....	<b>9-16</b>
<b>IP Port</b> .....	<b>9-16</b>
<b>MyAlarm Options</b> .....	<b>9-16</b>
<b>Gateway Numbers</b> .....	<b>9-16</b>
<b>Email Address</b> .....	<b>9-17</b>
<b>Email Options</b> .....	<b>9-17</b>
Open Close.....	9-17
Zones.....	9-17
System .....	9-17
Access.....	9-17
<b>SIA IP Prefix</b> .....	<b>9-21</b>
Account Number.....	9-21
Account Prefix.....	9-21
Receiver Prefix.....	9-21
<b>User Name/Password</b> .....	<b>9-21</b>
IP RAS Allowed.....	9-23
IP RAS Only If Disarmed.....	9-23
Report IP Session .....	9-23
Report IP Lockout .....	9-23
UDP Installer RAS .....	9-23
UDP User RAS .....	9-23
<b>COMMS TESTING</b> .....	<b>9-24</b>
<b>Send Test Report</b> .....	<b>9-24</b>
<b>Test Report Time</b> .....	<b>9-24</b>
<b>Test Report Period</b> .....	<b>9-25</b>
<b>Test Report Options</b> .....	<b>9-25</b>
Test If No Other Rpt.....	9-25
Test On Siren Reset.....	9-25
<b>Test Route</b> .....	<b>9-26</b>
<b>Dial Number Test</b> .....	<b>9-26</b>

**SECTION 10**

<b>DEVICE PROGRAMMING</b> .....	<b>10-1</b>
<b>DEVICE COMMANDS</b> .....	<b>10-1</b>
Device Status.....	10-1
LAN Secure.....	10-1

LAN Scan .....	10-2
LAN Watch.....	10-2
Keypad Volume.....	10-2
Keypad Contrast .....	10-2
Keypad Backlight.....	10-2
<b>KEYPAD &amp; READER OPTIONS .....</b>	<b>10-3</b>
Name.....	10-3
<b>Area Options.....</b>	<b>10-3</b>
All On Arming Allowed.....	10-3
Part On Arming Allowed.....	10-3
Disarming Allowed.....	10-3
Single Button Control.....	10-3
All User Areas.....	10-3
Zero Exit Time.....	10-4
PIN To Change Area.....	10-4
Home Area Only.....	10-4
<b>Home Area .....</b>	<b>10-4</b>
<b>General Options.....</b>	<b>10-5</b>
Enable Rear Tamper .....	10-5
Report Temperature.....	10-5
Installer Allowed .....	10-5
Show Alarm When Armed .....	10-5
Reader Area Control.....	10-5
Reader Badging.....	10-5
Enable Egress Input.....	10-5
Log Egress Events .....	10-5
<b>Indicator Options.....</b>	<b>10-6</b>
Extinguish.....	10-6
Greetings .....	10-6
Display Temperature.....	10-6
Display Area Icons .....	10-6
Trouble Alert Beeps.....	10-6
Entry Exit Warning .....	10-6
Part Exit Warning.....	10-6
Chime Tone .....	10-6
<b>Emergency Keys.....</b>	<b>10-7</b>
Audible Keypad Fire.....	10-7
Report Keypad Fire.....	10-7
Audible Kpad Medical.....	10-7
Report Kpad Medical.....	10-7
Audible Kpad Panic.....	10-7
Report Keypad Panic .....	10-7
<b>Door Assignment.....</b>	<b>10-8</b>
<b>Lockout Time .....</b>	<b>10-8</b>
<b>RF RECEIVER OPTIONS .....</b>	<b>10-9</b>
<b>Receiver Options.....</b>	<b>10-9</b>
Display RF Rcvr Trouble .....	10-9
Alarm RF Rcvr Tamper .....	10-9
Report RF Rcvr Tamper .....	10-9
Alarm RF Rcvr Jamming .....	10-9
Report RF Rcvr Jamming.....	10-9
Alarm Rcvr Comm Fail.....	10-9
Report Rcvr Comm Fail.....	10-9
<b>Supervision Time .....</b>	<b>10-9</b>
<b>RF Device Options .....</b>	<b>10-10</b>
Display RF Tamper .....	10-10
Report RF Tamper .....	10-10
Report RF Low Battery .....	10-10
Report Lost RF Devices .....	10-10
Open Zone On Lost RF.....	10-10
Audible Keyfob Panic .....	10-10
Report Keyfob Panic .....	10-10
Keyfob Func Part On .....	10-10
<b>Add RF Keypad.....</b>	<b>10-10</b>
<b>Delete RF Keypad .....</b>	<b>10-10</b>

View RF Device ID .....	10-10
<b>SERIAL DEVICE OPTIONS .....</b>	<b>10-11</b>
Device Type.....	10-11
Baud Rate .....	10-11
Flow Control .....	10-11
GSM/GPRS Status .....	10-11
GSM/GPRS Options .....	10-12
Auto Forward SMS.....	10-12
Forward SMS To Mail.....	10-12
CLI Trigger Table 1 .....	10-12
CLI Trigger Table 2 .....	10-13
SMS Control .....	10-13
Display Faults .....	10-15
Report Cable Lost .....	10-15
Report IP Conflict.....	10-15
Report Poll Fail .....	10-15
<b>SECTION 11</b>	
<b>SYSTEM PROGRAMMING .....</b>	<b>11-1</b>
<b>SYSTEM COMMANDS .....</b>	<b>11-1</b>
Panel Status .....	11-1
System Trouble.....	11-1
<b>SYSTEM TROUBLE MESSAGES .....</b>	<b>11-2</b>
Power Missing.....	11-2
AC Missing.....	11-2
Battery Low .....	11-2
Battery Missing.....	11-2
Low Battery .....	11-2
Box Tamper .....	11-2
Temperature Alert .....	11-2
Receiver Missing.....	11-2
Case Tamper.....	11-2
Receiver Jam.....	11-2
Comms Fail Route1 .....	11-2
Comms Fail Route2 .....	11-2
Sensor Watch Alert.....	11-2
Comms BUSS Trble .....	11-2
Default PIN Trble .....	11-2
Date & Time.....	11-2
Cabinet Tamper .....	11-2
Connection Trouble .....	11-2
Overload Condition .....	11-2
Zone Was In Alarm.....	11-3
Telco Line Fail .....	11-3
LAN+ Overload.....	11-3
COMM+ Overload.....	11-3
ACC+ Overload.....	11-3
Service Required .....	11-3
Memory Checksum .....	11-3
Phone Line In Use .....	11-3
Battery Trouble .....	11-3
History Log.....	11-3
Domestic Default .....	11-4
Factory Default .....	11-4
Template Default .....	11-5
TimeZone Array .....	11-5
Service Mode.....	11-5
<b>SYSTEM CLOCK.....</b>	<b>11-6</b>
Set Date And Time .....	11-6
Summertime On .....	11-6
Summertime Off.....	11-6
Australian Daylight Savings Times.....	11-6
Locale.....	11-7
<b>SYSTEM POWER OPTIONS.....</b>	<b>11-7</b>

<b>AC Options</b> .....	<b>11-7</b>
Display AC Fail.....	11-7
Report AC Fail.....	11-7
Sync Clock to AC .....	11-7
Random AC Reporting 2hr .....	11-7
AC Fail After 1 Hour .....	11-7
Display Clock Trouble.....	11-7
<b>Battery Options</b> .....	<b>11-8</b>
Display Battery Fail.....	11-8
Report Battery Fail.....	11-8
Battery Test On Arming .....	11-8
OK To Arm Low Battery.....	11-8
<b>Fuse Options</b> .....	<b>11-8</b>
Display COMM+ O/Load.....	11-8
Report COMM+ O/Load.....	11-8
Display +12v O/Load .....	11-9
Report +12v O/Load .....	11-9
Display LAN O/Load.....	11-9
Report LAN O/Load.....	11-9
<b>HORN SPEAKER OPTIONS</b> .....	<b>11-9</b>
Tone.....	11-9
Speed .....	11-9
Volume .....	11-9
Siren Swinger .....	11-10
<b>TIMEZONES</b> .....	<b>11-10</b>
Name.....	11-11
Time.....	11-11
Day .....	11-11
TimeZone Options.....	11-12
Invert Logic .....	11-12
Master Can Edit.....	11-12
<b>SYSTEM HOLIDAYS</b> .....	<b>11-12</b>
Holiday Name.....	11-12
Start Stop Dates.....	11-13
<b>SYSTEM OPTIONS</b> .....	<b>11-13</b>
<b>General Options</b> .....	<b>11-13</b>
Display LAN Fail.....	11-13
Report LAN Fail.....	11-13
Alarm On LAN Fail.....	11-13
Cannot Change Own PIN.....	11-13
Monitor Default PINs .....	11-13
PIN Always Required.....	11-14
Display Menu Numbers.....	11-14
<b>Area Options</b> .....	<b>11-14</b>
Area 1 Common .....	11-14
First Open Last Close .....	11-14
Reset Siren All Users.....	11-14
Power Up As Down.....	11-14
Fault ACK All Areas .....	11-14
Delay Trouble Beeps .....	11-14
Power Up Disarmed .....	11-14
<b>Keypad Idle Screen</b> .....	<b>11-15</b>
<b>Keypad Hi/Lo Temp</b> .....	<b>11-15</b>
<b>Installer Options</b> .....	<b>11-15</b>
Report Installer .....	11-15
Report Prog Change .....	11-15
Restrict Installer PIN.....	11-15
Auto Exit Install 2hr .....	11-16
Auto Exit Service 2hr .....	11-16
Multi Tenant Mode .....	11-16
Allow Defaulting .....	11-16
<b>Language</b> .....	<b>11-16</b>
<b>Site Name</b> .....	<b>11-16</b>

**SYSTEM TESTING.....11-17**  
 Walk Test All Zones.....11-17  
 Battery Test .....11-17

**SECTION 12**

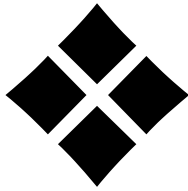
**PROGRAMMING EXAMPLES ..... 12-1**  
 Opening a Door using a Single Digit Code ..... 12-1  
 Opening a Garage Door Using a 4 Button RF Keyfob ..... 12-1  
 Auto Arming an Area..... 12-1  
 Operating an Output with a TimeZone ..... 12-2  
 Unlock a Door and Disarm Area 1 using a LAN Reader..... 12-2  
 Unlock a Door and Arm/Disarm Area 1 using a LAN Reader ..... 12-2  
 Using CLI to establish Upload/Download Connection ..... 12-3  
 Sending SMS Alarm Reports..... 12-3

**SECTION 13**

**SPECIFICATIONS ..... 13-1**

**SECTION 14**

**INDEX ..... 14-1**



# Overview

## FEATURES

Listed below are the main features of the Solution 144 Control Panel.

- ◆ Individual Box Tamper Circuit Monitoring
- ◆ Report Via Email (Internet)
- ◆ Telephone Line Busy Tone Detect
- ◆ RAS Intelli-Connect® CLI Caller Line Identification
- ◆ Daylight Savings
- ◆ Senior Watch
- ◆ System Maintenance Interval Reminder
- ◆ System Weekly Test Reminder
- ◆ Area Inactivity Interval
- ◆ Temporary PIN
- ◆ Dual Reporting
- ◆ Dual Redundant Reporting
- ◆ Alarm Report Abort/Cancel Options
- ◆ 8 Programmable Holiday Calendars
- ◆ 16 Programmable Door Assignments
- ◆ 8 On-board Zones (Exp To 144 Zones)
- ◆ Fire Alarm Verification
- ◆ 255 PIN Users
- ◆ 4 Supervised High Power Digital Outputs
- ◆ 1 Relay 2 Amp Form (C) Contact (Expandable to 32)
- ◆ Supervised Siren Driver
- ◆ Partitionable To 8 Areas
- ◆ Dialler Reports SIA, Contact ID, SMS and Email Formats
- ◆ Supervised LAN Keypads (Maximum 16 Keypads)
- ◆ Keyswitch Input
- ◆ 1000 History Event Memory
- ◆ EMI / Lightning Transient Protection
- ◆ Fully Menu Text Programmable
- ◆ Programmable Via Solution Link Software (Remote/Direct)
- ◆ Telephone Line Fail Monitor
- ◆ Time Executed Functions
- ◆ 60+ Output Event Types
- ◆ Exit Restart
- ◆ Expansion Module Supervision
- ◆ DTMF Tone Decoder Built In
- ◆ Remote Arming

## OVERVIEW

### Zones

The Solution 144 control panel provides up to 144 separate zones of protection. Zone programming determines the panel's response to open/short and tamper conditions on the zone loop.

### Areas

The control panel supports up to 8 separate areas. You can assign all zones to a single area, or you can assign each zone to a combination of different areas.

You can arm and disarm the control panel by area, alternatively, you can arm and disarm several areas at the same time.

### Dialler

The control panel has a built-in dialler to send reports to the receiving party (ie. Security company monitoring station, mobile phone etc).

### Keypads

You can connect a maximum of 16 fully supervised keypads to the control panel. The available current affects the total number of keypads that you can connect without the need to provide additional power supplies.

### History Log

The control panel can store up to 1000 history events from all 8 areas. All events are stored in the log, even if they are programmed not to report via the on-board dialler.

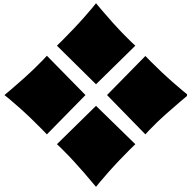
You can view the control panel's history log via keypad, serial printer (optional), or by connection of a personal computer (direct/remote) using the Solution Link upload/download software.

### Programming

You can program the control panel either by a keypad or using a personal computer using the Solution Link upload/download software.

**This page left intentionally blank**





# Installing the Hardware

## ABOUT THE PANEL

### ENCLOSURES

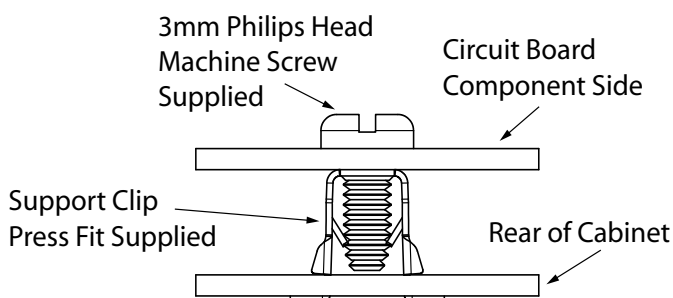
The MW720B - Small Enclosure and MW730B - Large Enclosure have been designed to reduce installation time and improve aesthetics on larger installations where often multiple enclosures need to be located in close proximity to each other.

A number of new features have been incorporated including a new style tamper bracket which can be easily installed before or after the enclosure is mounted to the wall, an anti tamper lid which insures the cabinet tamper triggers when the lid is removed, easier access for flexible and rigid conduits, additional 20mm cable entry knockouts and a new board mounting system using removable spring clips.

The MW720B and MW730B enclosures include numerous holes, allowing the PCB mounting clips to be positioned in the most appropriate location for each installation.



*For ease, it is recommended that the PCB mounting clips are installed from the rear of the enclosure before mounting it to the wall.*



**Figure 1: PCB and Mounting Clip Installation Diagram**

## ENCLOSURE FIXING METHOD

### MW720B - Small Enclosure

Use appropriate fasteners capable of handling a minimum of 6kg to fix the cabinet against a sturdy surface using the mounting holes provided.

### MW730B - Large Cabinet

Use appropriate fasteners capable of handling a minimum of 12kg to fix the cabinet against a sturdy surface using the mounting holes provided.

## INSTALLING THE TAMPER SWITCH

The tamper switch can be located on either the left or right hand side of the cabinet to suit the installation. Before installing the bracket, fit the tamper lead to the switch and then insert it into the bracket.

Once the enclosure has been mounted to the wall, insert the tamper bracket into the rectangular hole in the top flange of the enclosure and then slide the base of the bracket toward the top until the tamper switch locates in the rear of the enclosure.

Depress the tamper a few times with your finger to ensure smooth operation.



**Figure 2: Tamper Bracket Installation**

## ENCLOSURE MODULE SPACES

The MW720 enclosure has space for 2 large modules or 4 small modules while the optional MW730 enclosure has space for up to 4 large modules or 8 small ones. The enclosures have been designed so that any combination of large and small units can be neatly mounted together on the wall.

Each module is mounted to the enclosure using 4 or more clip in standoffs. The clips can be inserted from the rear of the enclosure before mounting it to the wall, or from the front of the enclosure after it has been mounted. Both methods should be performed using your finger tips to

prevent damage to the standoff. (Standoffs and screws are supplied with each module).

All compatible add on modules will mount on these spaces. See below for list of modules which can be added to the control panel.

Module	Space Occupied
Solution 144 Control Panel	2 Module Spaces
CM704B Zone Expander	1 Module Space
CM705B Universal Expander	2 Module Spaces
CM710B Output Expander	1 Module Space
CM720B LAN Power Supply	1 Module Space
CM760B Real Time Clock	1 Module Space
CM797B LAN Isolator Module	1 Module Space
CM195B RF Receiver Expander	1 Module Space

**Table 1: Expansion Options**

Use the above table to help determine which size cabinet you will require for the job.

On some export models, one module space will not be available as the mains transformer mounts in this location.

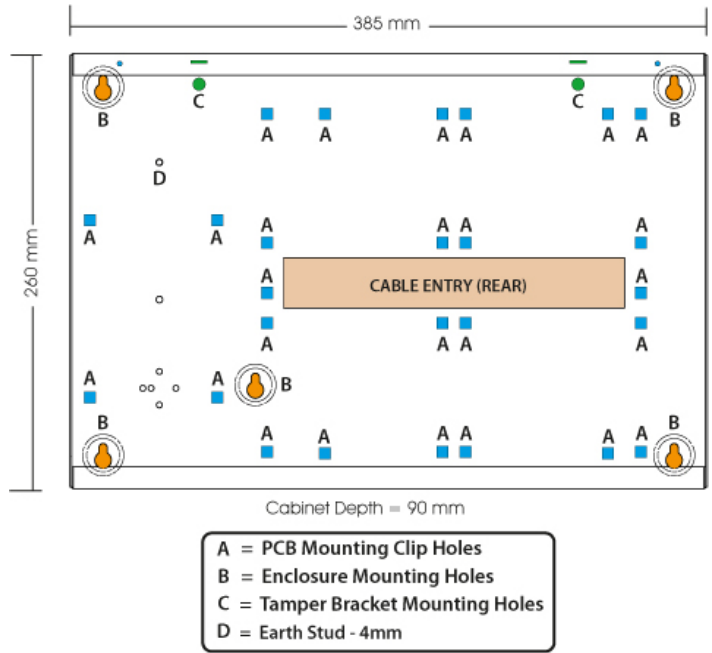
**INSTALLING PANELS AND MODULES**

Once the enclosure is secured in place, install the panels and modules onto the mounting clip using the supplied 3mm screws. Do not over tighten the screws.

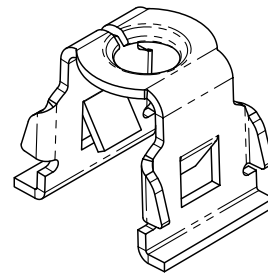
When fitting panels or large modules, you should use 5 mounting clips, one in each corner of the PCB and one in the middle of the PCB underneath the main terminal blocks. When mounting small modules, only 4 clips are required, 1 in each corner.

Both enclosures are supplied with tamper switches, tamper leads, tamper brackets and a quantity of mounting clips and screws. If required, additional mounting clips and screws may be purchased in bags of 50 clips (10 packs x 5pcs). (P/N: MW890)

**Note** The supplied mounting clips are designed to use the 3mm machine screws supplied with the enclosure. The use of self tapping screws will damage the clips.

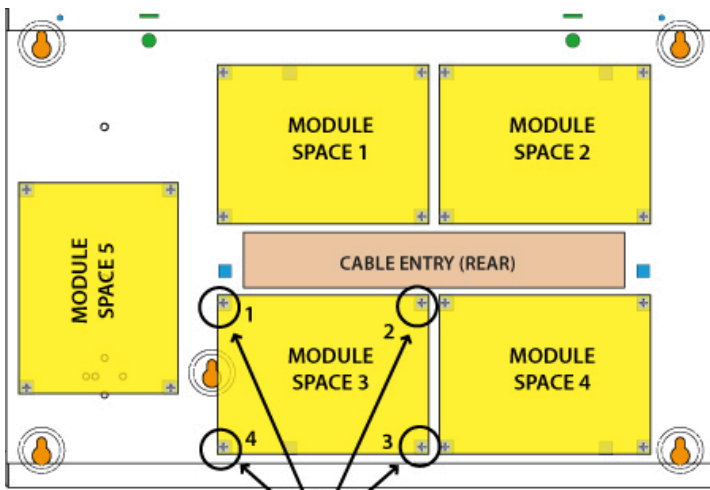


**Figure 3: MW720B - Small Enclosure Details**

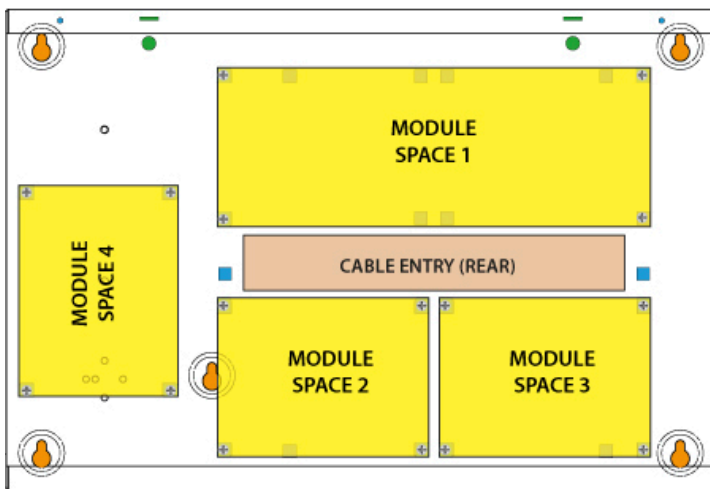


**Figure 4: PCB Mounting Clip**

The following example shows the MW720B -Small enclosure configured using 4 small modules.



When installing small modules, you should fit 4 mounting clips as shown.



When installing large modules, you should fit 5 mounting clips as shown. Clip 5 provides support under the main terminal block only. No screw is fitted.

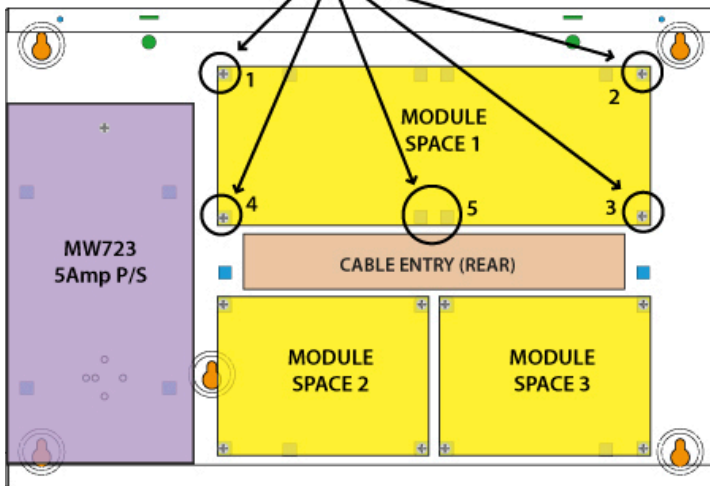
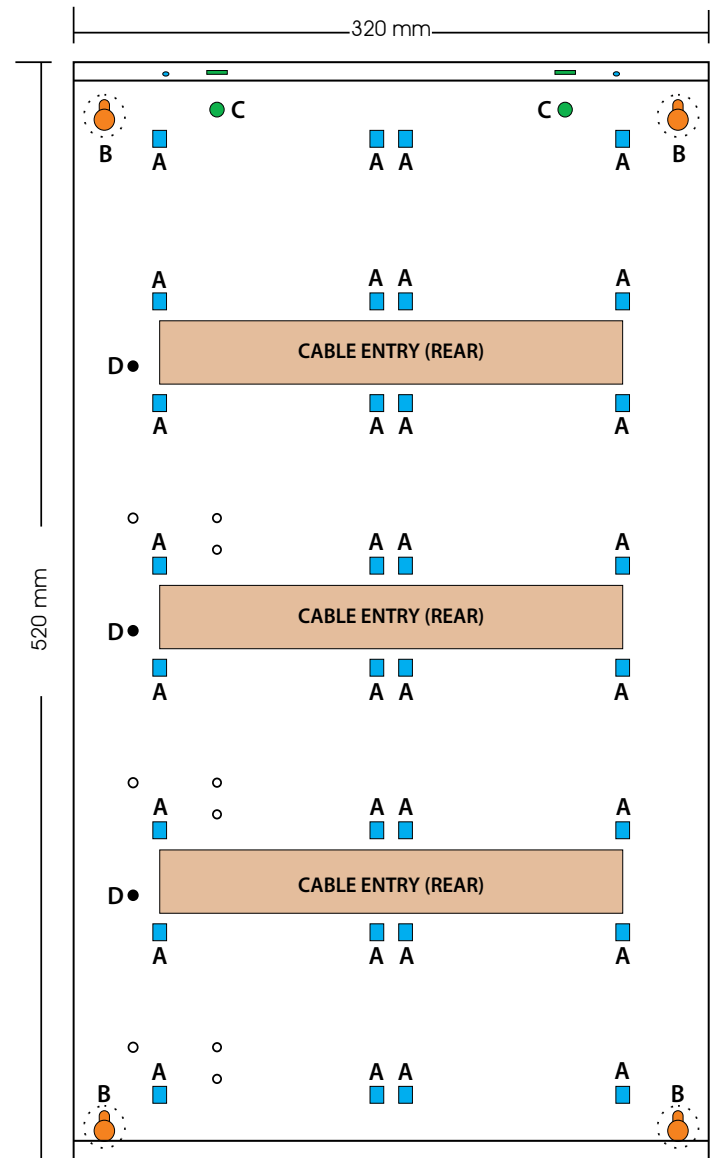


Figure 5: MW720B Configuration Examples

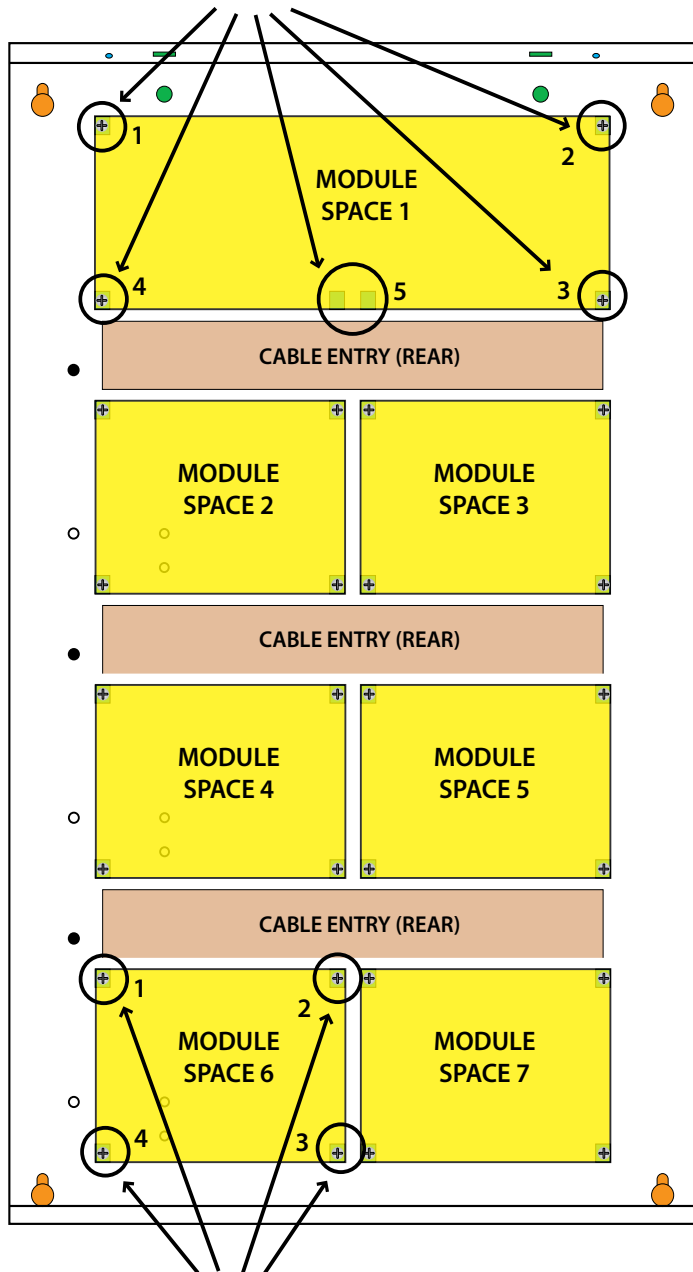


- A = PCB Mounting Clip Holes
- B = Enclosure Mounting Holes
- C = Tamper Bracket Mounting Holes
- D = Earth Stud - 4mm

Figure 6: MW730B - Large Enclosure Details

The following examples show the MW730B - Large enclosure configured using 6 small modules and 1 large module.

When installing large modules you should fit 5 mounting clips as shown. Clip 5 provides support under the main terminal block only. No screw is fitted.



When installing small modules, you should fit 4 mounting clips as shown.

Figure 7: MW730 Configuration Examples

### CONNECTING POWER TO THE PANEL

For normal operation, the panel requires both AC and DC power sources. The AC source can be provided either by an external adapter or by an internal transformer depending on the model and country of sale.

When connecting using the AC adapter, feed the cable in to the enclosure and terminate the wires on the removable terminal block supplied before connection it to the PCB.

If using a 3 wire Adaptor, then the earth wire should also be terminated onto the terminal block. Always check the orientation of the terminal block with the PCB markings before connecting it to the PCB.

### CONNECTING THE BATTERY

The panel is supplied with a set of battery leads to suit the chosen enclosure. Connect the Red Battery lead to the Battery (+) terminal and the Black Battery lead to the Battery (-) terminal on the PCB.

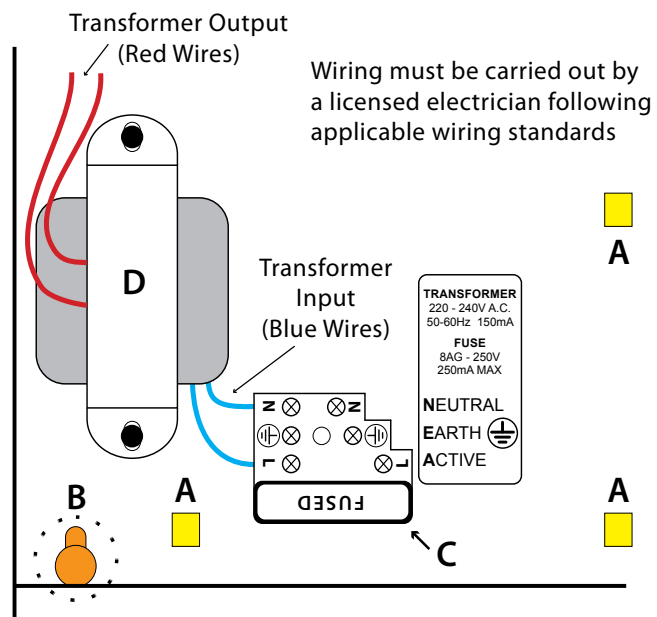
Once terminated onto the PCB connect the other end of the leads to the battery paying attention to the polarity.

### AC MAINS TRANSFORMER OPTION

On models with an internal transformer, a permanent connection shall be made to the mains supply. See Figure 8. This must be completed by a suitably qualified electrician according to the applicable wiring standards and regulations.

Next connect the transformer output wires (red) to the removable terminal block supplied and then connect it to the PCB. Always check the orientation of the terminal block with the PCB markings before connecting.

**Note** For permanently connected equipment, a readily accessible disconnect device shall be installed in a location near to the equipment.



- A = PCB Mounting Clip Holes
- B = Enclosure Mounting Holes
- C = Fused Terminal Block
- D = Transformer

Figure 8: Internal Transformer Connection Diagram

## PANEL LED INDICATORS

The control panel PCB has two LED indicators (Dialler and Status LED's) which display the following information.

Condition	Meaning
Off	Offline
On	On Line (Dialling/Answered)
Flashing	Incoming Call

**Table 2: Dialler Indicator LED**

Condition	Meaning
Off	Error
On	Error
Flash Once Every 2 Seconds	OK
Flash Fast	AC or Battery Trouble

**Table 3: Status Indicator LED**



During factory defaulting the Status and Dialler LED indicators will flash alternatively for approximately 15 seconds.

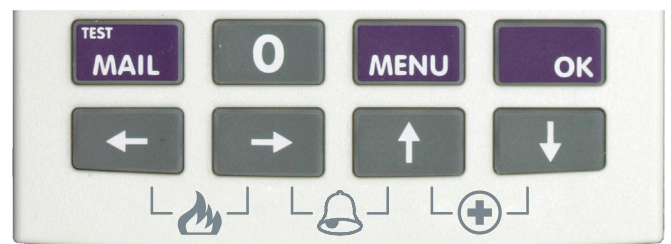
## ABOUT THE KEYPAD

The keypad has 20 keys that allow you to input instructions and navigate the programming menu's as required. Some keys have a secondary function which is activated by pressing and holding them down for two seconds. Each key is described below.

Key	Description
0 to 9	The numeric keys allow you to enter your user PIN when required.
MENU	Use the [MENU] and the numeric keys to enter commands. The [MENU] key is also used to go back one level when navigating through menus or to exit a programming location without saving changes.
ALL ON ON	The [ON] key allows you to turn an area or output on. To turn all areas on at the same time when the system has been partitioned, press and hold the [ON] key for two seconds.
BYPASS PART	The [PART] key allows you to turn an area Part On. This key can also be used to bypass a zone or multiple zones when you press and hold for two seconds after you enter your PIN.
ALL OFF OFF	The [OFF] key allows you to turn an area or output off. To turn all areas off at the same time when the system had been partitioned, press and hold the [OFF] key for two seconds after you enter your PIN.
OK	The [OK] key allows you to save any changes and exit the command.

Key	Description
TEST MAIL	The [MAIL] key allows you to read stored mail. This key can also be used to initiate a dialler test when you press and hold for two seconds.
←	The [←] key allows you to move the cursor left when programming text or telephone numbers.
→	The [→] key allows you to move the cursor right when programming text or telephone numbers.
↑	The [↑] key allows you to navigate through menus or to toggle characters when programming telephone numbers.
↓	The [↓] key allows you to navigate through menus or to toggle characters when programming telephone numbers. Pressing The [↓] key will display current trouble conditions when the area that the keypad is displaying is disarmed.
→ + ↑ for 2 sec	Press and hold the [→] and [↑] keys together for 2 seconds will initiate a panic emergency alarm to be triggered. If programmed, the sirens will sound and the monitoring station will be notified.
← + → for 2 sec	Press and hold the [←] and [→] keys together for 2 seconds will initiate a fire emergency alarm to be triggered. If programmed, the sirens will sound and the monitoring station will be notified.
↑ + ↓ for 2 sec	Press and hold the [↑] and [↓] keys together for 2 seconds will initiate a medical emergency alarm to be triggered. If programmed, the sirens will sound and the monitoring station will be notified.











**Table 4: Keypad Key Functions**





**Figure 9: Keypad Emergency Alarm Trigger's**

### STATUS ICONS / LED'S

The following table lists the function of each of the ICON symbols and LED indicators on the keypad display.










Icon	Status	Meaning
		The keypad can be programmed to display area icons (1 to 8) that allow users to easily identify which areas have been turned on or off without the need to toggle between areas (See MENU 6-1-4).
	<b>On</b>	The area is turned All On or Part On
	<b>Off</b>	The area is turned Off
	<b>Flashing Fast</b>	The area has an alarm
	<b>On</b>	System power is normal
	<b>Flashing</b>	System power is missing
	<b>Flashing</b>	A fire alarm is active
	<b>Off</b>	No fire alarm
	<b>On</b>	Fire alarm in memory (Turn the area All On and Off to Clear).
	<b>On</b>	The existing service or trouble condition has been acknowledged.
	<b>Off</b>	No service or trouble conditions exist
	<b>Flashing</b>	A service or trouble condition is present that has not been acknowledged.
	<b>On</b>	The area is turned Part On.
	<b>Off</b>	The area is not turned Part On.
	<b>On</b>	The area is turned off.
	<b>Off</b>	The area is turned All On or Part On
	<b>On</b>	The area is turned All On or Part On
	<b>Off</b>	The area is turned Off
	<b>On</b>	All messages have been read.
	<b>Off</b>	Message queue is empty
	<b>Flash</b>	An unread message is in the queue.
	<b>On</b>	Area is ready to turn on (All On / Part On)
	<b>Off</b>	Not ready, Zone Open
	<b>On</b>	All On
	<b>Flashing</b>	Alarm

	<b>On</b>	Area is off.
	<b>Flashing</b>	Area not ready to turn on
	<b>Flashing</b>	Installer programming mode is active.

**Table 5: ICON & LED Indicator Meanings**

### KEYPAD TONES

All keypads emit several distinct tones and display text to alert you to system events. The volume of the keypad tones can be adjusted in MENU 6-1-0.

Type	Meaning
	When a fire zone sounds an alarm, the keypad will sound 3 seconds on and 2 seconds off (repeat).
	When a burglary zone activates while your system is turned on, your keypad emits a continuous siren tone. It sounds for the time set by your security company.
	When a system component is not functioning properly, your keypad sounds 4 fast short beeps followed by a 5 second pause (repeat).
	Pressing any key on the keypad sounds one short beep, indicating that the key press is accepted.
	When you enter the premises through a zone programmed for entry delay, the keypad sound a Hi/Low tone to remind you to turn off the area. If the area is not turned off before the entry delay expires, an alarm condition will sound and a report may be sent to your alarm company.
	After you turn an area All On, the keypad will sound 1 short beep every second. During the last 10 seconds fast short beeps will be heard. If you don't exit before the delay time expires and an exit delay door is faulted, an alarm occurs.
	If you enter an incorrect value when programming, the keypad will sound a 2 second tone.
	The keypad will sound a Lo/Hi tone to indicate you have entered MENU Mode and a Hi/Lo tone to indicate you have exited MENU mode.
	The keypad sounds fast short beeps to alert you when a zone programmed for chime is faulted or unsealed.

**Table 6: Keypad Tones**

### KEYPAD & READERS SETUP

The control panel can have a maximum of 16 keypads and/or readers connected via the LAN terminals. Each keypad or reader must be set to a unique address before they will operate.

Each keypad or reader needs to be assigned to a home area via MENU 6-1-3. This sets the area the keypad or reader will display and control by default. Keypads and readers can be locked to a home area or allowed to roam or move between areas. At factory default, the home area is factory default to operate Area 1.

Set each keypad or reader address using "Table 7: DIP Switch Address Settings" on page 2-7 and "Table 8: Rotary Switch Address Settings" on page 2-7 as a guide.



*Only 1 keypad can be assigned to each address. All keypads are supplied from the factory set to address 1. (OFF-OFF-OFF-OFF).*

### DIP SWITCH ADDRESS SELECT

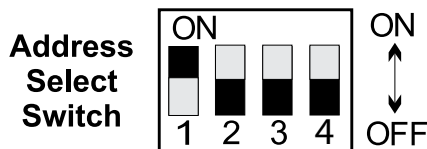


Figure 10: Keypad DIP Switch Address Settings

DIP Switch Address Settings				
Keypad/Reader N°	S1	S2	S3	S4
1	Off	Off	Off	Off
2	On	Off	Off	Off
3	Off	On	Off	Off
4	On	On	Off	Off
5	Off	Off	On	Off
6	On	Off	On	Off
7	Off	On	On	Off
8	On	On	On	Off
9	Off	Off	Off	On
10	On	Off	Off	On
11	Off	On	Off	On
12	On	On	Off	On
13	Off	Off	On	On
14	On	Off	On	On
15	Off	On	On	On
16	On	On	On	On

Table 7: DIP Switch Address Settings

### ROTARY SWITCH ADDRESS SELECT

Keypads and readers fitted to the system must be assigned a unique address on the LAN. Some keypads and readers include a rotary address switch for quick selection.

The following table shows how to set the address setting for each keypad and reader, as well as the number of devices the panel can support.

Rotary Switch Address Settings	
Address Number	Keypad/Reader N°
1	1
2	2
3	3
4	4
5	5
6	6
7	7
8	8
9	9
10	10
11	11
12	12
13	13
14	14
15	15
16	16

Table 8: Rotary Switch Address Settings

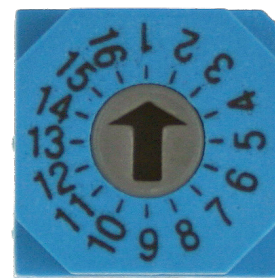
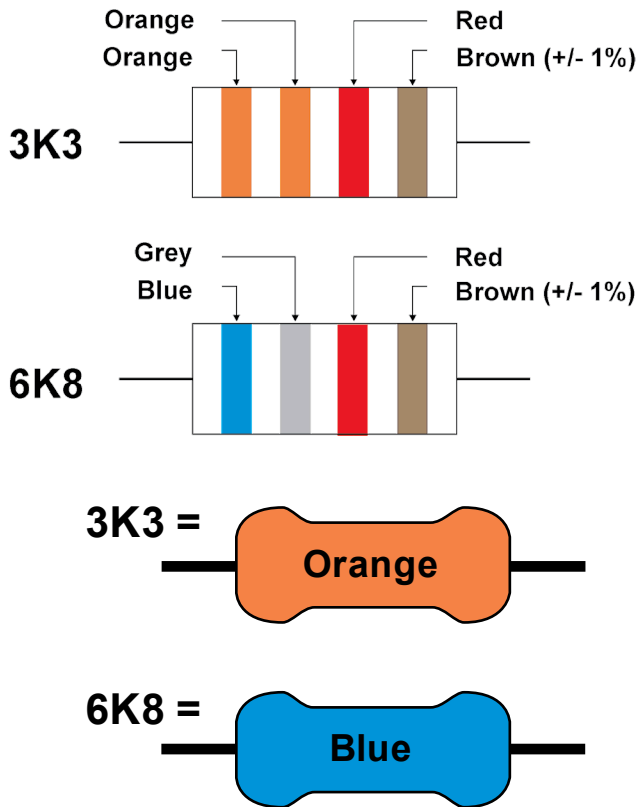


Figure 11: Rotary Switch Address Settings

**EOL RESISTOR COLOUR CODE**

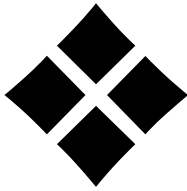
**Figure 12:** EOL Resistor Colour Chart

Selected Resistor Colour Codes				
Value	Band 1	Band 2	Band 3	Band 4
2K2	RED	RED	RED	BROWN
4K7	YELLOW	VIOLET	RED	BROWN
5K6	GREEN	BLUE	RED	BROWN
8K1	GREY	BROWN	RED	BROWN
10K	BROWN	BLACK	ORANGE	BROWN
12K	BROWN	RED	ORANGE	BROWN
22K	RED	RED	ORANGE	BROWN

**Table 9:** EOL Resistor Colour Codes

Because of variations in the colours used to mark resistors it is recommended that you use a multimeter to verify the value of resistors rather than rely on the colour code.





# Wiring Diagrams

## ZONE WIRING



Figure 13: N/C No EOL Zone

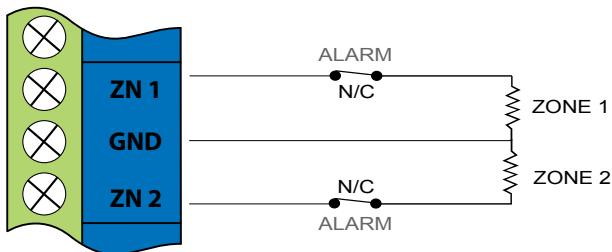


Figure 14: N/C Single EOL Zone

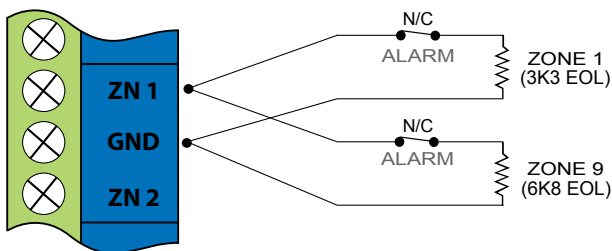


Figure 15: N/C Split EOL Zone

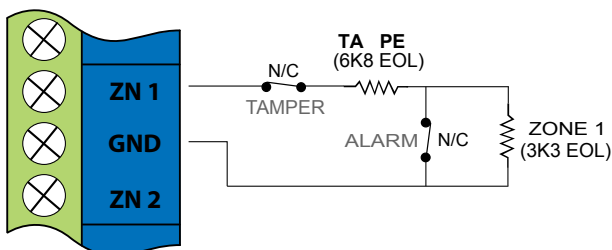


Figure 16: N/C Zone With Tamper

using Normally-Open Alarm Contacts you must select Inverted Seal for each zone in MENU 3-1-8. A shorted loop is a tamper condition for all EOL zone configurations..



Figure 17: N/O No EOL Zone

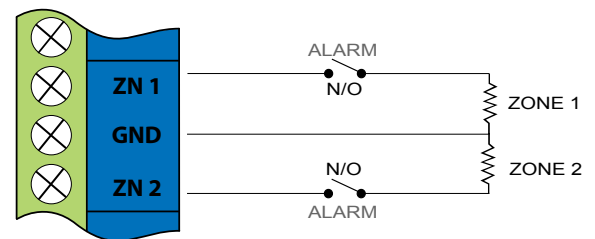


Figure 18: N/O Single EOL Zone

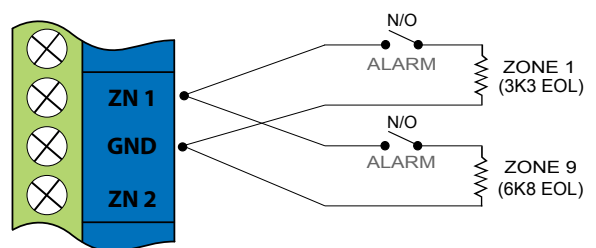


Figure 19: N/O Split EOL Zone

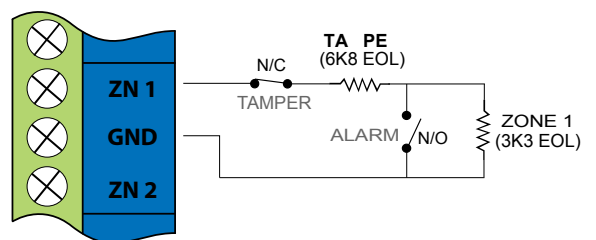


Figure 20: N/O Zone With Tamper



The Above diagrams display the zone wiring configurations using Normally-Closed Alarm contacts and Normally-Open Alarm Contacts. When

### EOL RESISTOR COLOURS AND VALUES

Use either the 4 colour, or solid colour resistors supplied.

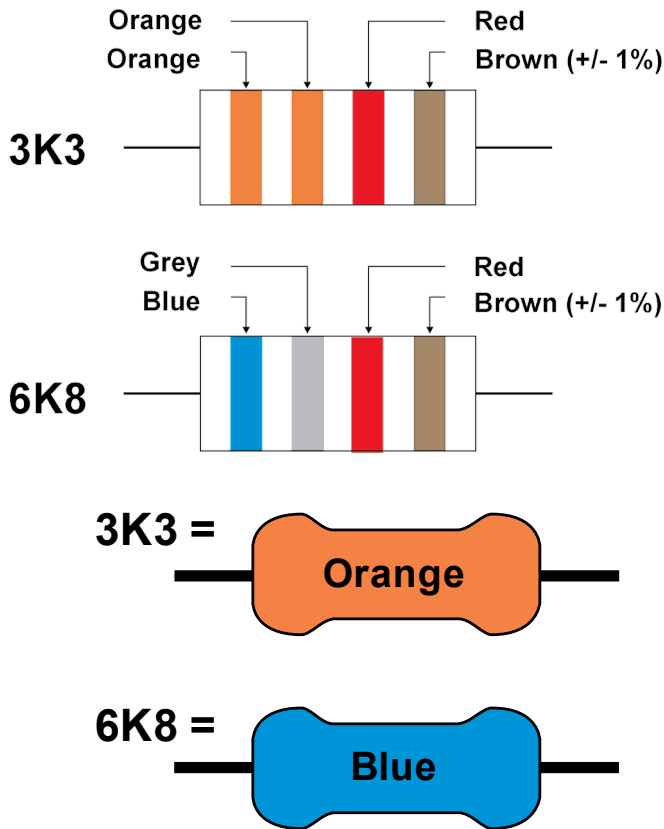


Figure 21: EOL Resistor Colour Chart

### BOARD CONNECTORS

The following table lists the various sockets, pin headers and switches located on the panel and their functions.

Connector	Description
Service	This socket allow you to connect a service Keypad to the panel during installation.
Tamper	This socket is used to connect the panel enclosure tamper switch.
Default	This push button is used to reset the control panel back to factory default.
Voice Module	This is used to connect the optional Voice Command Module (CM101B).
Serial	This socket is used to connect serial devices to the control system like a Serial STU.
Telco	This is a RJ12 6P/4C connector that allows you to connect the control panel to the PSTN telephone line.
Relay	The relay select PIN's allow you to easily program the relay common contact to switch either +12v or GND by fitting a plug on link.

Table 10: Board Connector Descriptions

### TERMINAL DESCRIPTIONS

N°	Name	Description
1	Earth	Earth wire from this terminal is connected to the Mains earth.
2	~ (AC)	Connection of the AC plug pack transformer
3	~ (AC)	
4	BAT (-)	Negative and positive connections to the stand-by battery. 12 VDC / 7AH
5	BAT (+)	
6	+12 V	These terminals are used to power detectors and LAN devices up to 750 mA.
7	+12 V	
8	+12 V	
9	GND	
10	GND	
11	GND	
12	LAN +	These terminals are used to power LAN devices up to 750 mA.
13	LAN -	
14	LAN A	Connect the LAN A data terminal of any LAN device (eg. Keypads, expansion boards) to this terminal. The control panel supports up to 300 m of 24/0.20 (18 AWG) wire on these terminals.
15	LAN B	Connect the LAN B data terminal of any LAN device (eg. Keypads, expansion boards) to this terminal. The control panel supports up to 300 m of 24/0.20 (18 AWG) wire on these terminals.
16	COMM+	Alarm power capable of providing a maximum of 2 Amp (+). This terminal is PTC Fuse protected.
17	OUT 1	Programmable output, capable of providing a maximum of 500 mA (-). This terminal is PTC Fuse protected.
18	OUT 2	
19	OUT 3	
20	OUT 4	
21	N/C	2 A @ 24 VDC Relay Output - Form C contact
22	COM	
23	N/O	
24	INPUT	Programmable Input for RF Receivers, Keyswitch and other devices.
25	ZN 1	Zone 1 and 9 sensor loop input (+).
26	GND	Common (-) for Zone 1 and 2 sensor loop.
27	ZN 2	Zone 2 and 10 sensor loop input (+).
28	ZN 3	Zone 3 and 11 sensor loop input (+).
29	GND	Common (-) for Zone 3 and 4 sensor loop.
30	ZN 4	Zone 4 and 12 sensor loop input (+).
31	ZN 5	Zone 5 and 13 sensor loop input (+).
32	GND	Common (-) for Zone 5 and 6 sensor loop.
33	ZN 6	Zone 6 and 14 sensor loop input (+).
34	ZN 7	Zone 7 and 15 sensor loop input (+).
35	GND	Common (-) for Zone 7 and 8 sensor loop.
36	ZN 8	Zone 8 and 16 sensor loop input (+).
37	IN	These terminals are used to connect the telephone line from the street.
38	IN	
39	OUT	These terminals are used to connect the premises telephones.
40	OUT	

Table 11: Terminal Block Descriptions and Functions

### LAN OVERVIEW

The control panel communicates with other system module devices via the built in RS485 LAN or Local Area Network.

For increased security, the system uses anti-substitution technology and a proprietary data encryption algorithm to communicate with all LAN modules.

When using the recommended cable types the LAN can be up to 1200 metres in length, or even greater when LAN isolators are used.

See the CM797 LAN Isolation Module reference guide for more information on how to use LAN isolators to increase the overall LAN length, improve surge immunity protection and prevent earth loops.



*It is recommended that one or more CM797 Isolators be used when connecting the LAN between multiple buildings.*

### LAN WIRING

Figure 21 and Figure 22 show the two recommended module connection diagrams.

The method shown in Figure 21, is only recommended for use where the total LAN length is 300metres or less and the system is not installed in a electrically noisy environment. In this case it is possible to use 7/0.20 or 14/0.20 security cable (non twisted) provided that module voltage levels are maintained within specification.

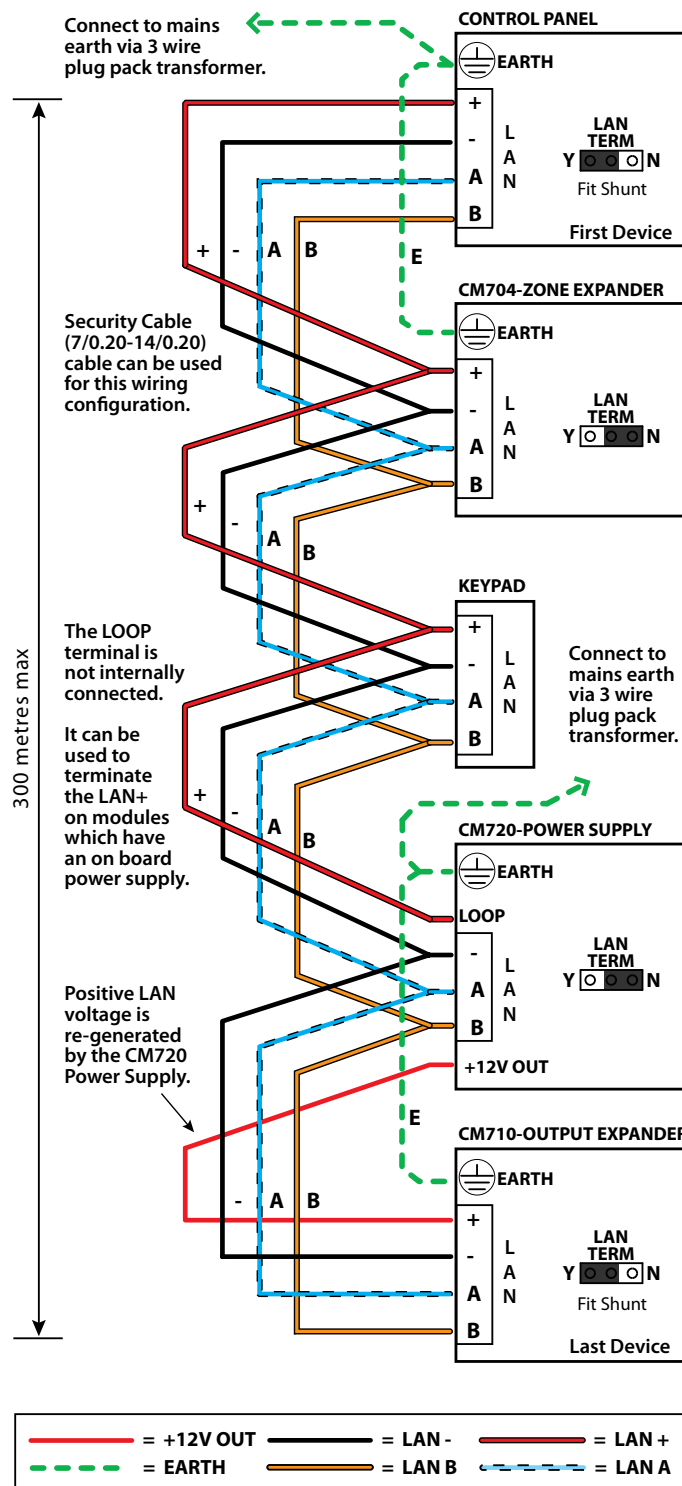
The method shown in Figure 22, offers the greatest immunity to noise interference and voltage surges. This connection method is recommended where the total LAN length is greater than 300metres. When using twisted pair cable the LAN length can be up to 1200metres, and this can be extended even further when using LAN isolators.

The LAN can be wired using the daisy chain method as shown, where each module is wired back to the panel on the same cable run or using a star configuration, where individual modules are wired back to the panel on individual wires.

Un-shielded cable can be used successfully in many situations however for the highest reliability and performance in areas prone to frequent electrical storms or high levels of electrical interference, shielded twisted pair cable should be used.

LAN+ and LAN- should not be used to power detectors or other external devices. These devices should be powered from the +12V terminals on the panel or via an external power supply.

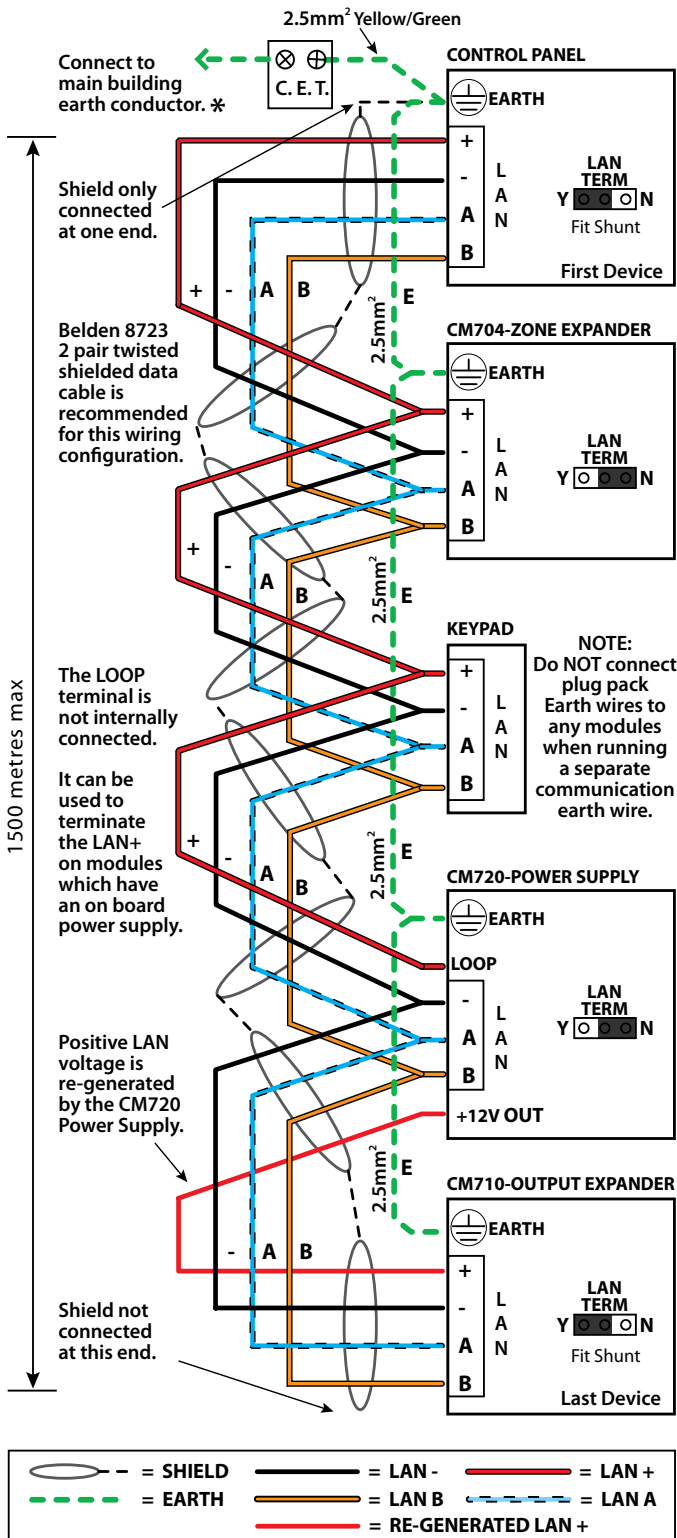
When wiring modules with built in power supplies like the control panel and the CM720B Power Supply, do NOT connect the EARTH wire from any 3 wire plug pack to the module's EARTH input terminal, if you have installed a separate communication earth wire.



**Figure 22: LAN Connection Using 2 Pair Security Cable Recommended for LAN Lengths 300 metres or less.**

The LAN A and LAN B wires are not interchangeable. Make sure that the LAN A wires from all modules connect to LAN A on the panel and LAN B wires from all modules connect to LAN B on the panel.

Do not connect the positives of two power supply sources together. When wiring the LAN to modules that are self powered, or powered from an external source you should terminate the LAN+ into the terminal marked LOOP. This terminal is simply a termination point and is not internally connected.



**Figure 23: LAN Connection Using Twisted Pair Cable Recommended for LAN Lengths greater than 300 metres.**

The LAN- terminals from all modules must be connected together for correct operation.

### SYSTEM EARTHING

When running a CET communications Earth as per Figure 24, the communication earth should be connected to the earth terminal on each module and then connected back through the CET to the main building earth conductor.

Do NOT connect the plug pack transformers earth wire to any modules earth terminal.

**Note** If a separate Communications Earth wire is installed, Do NOT connect the EARTH wire from any 3 wire plug pack to any modules EARTH input terminal.

If a separate communications earth is NOT being used, then you should connect the earth wire from the 3 wire plug pack to the panels earth terminal as shown in Figure 22.

When using shielded cable, the shield of each length of cable should only be connected to a protective earth at one end. Do not allow the shield to make contact with negative 0 volts, ground or any other wiring within the system.

All earth wiring should be carried out in accordance with the local wiring regulations in your area.

### TERMINATING THE LAN

For reliable operation the system LAN must be terminated correctly. The control panel and all LAN modules include a LAN TERM pin header and shunt which is used to connect the termination resistor on the module.

When the shunt is installed between the Y pin and the centre pin, the terminator is fitted and when the shunt is between the N pin and the centre pin the terminator is not fitted.

Where all modules are connected to the panel on a single cable run, (Daisy Chained) the terminators should be installed on the first and last modules on the LAN.

If the modules are connected to the panel via multiple cables all running back to the control panel (Star Configuration) then the terminators should be installed on the modules at the end of the two longest cable runs.

There are no LAN terminators on keypads. If a keypad is one of the two furthest devices from the control panel then a 470 ohm 1/2watt resistor can be fitted at the keypad between the LAN A and LAN B terminals.

In smaller installations where no LAN modules have been installed there is no need to fit the termination resistor on the control panel.

**Note** The LAN must be terminated correctly for proper operation.

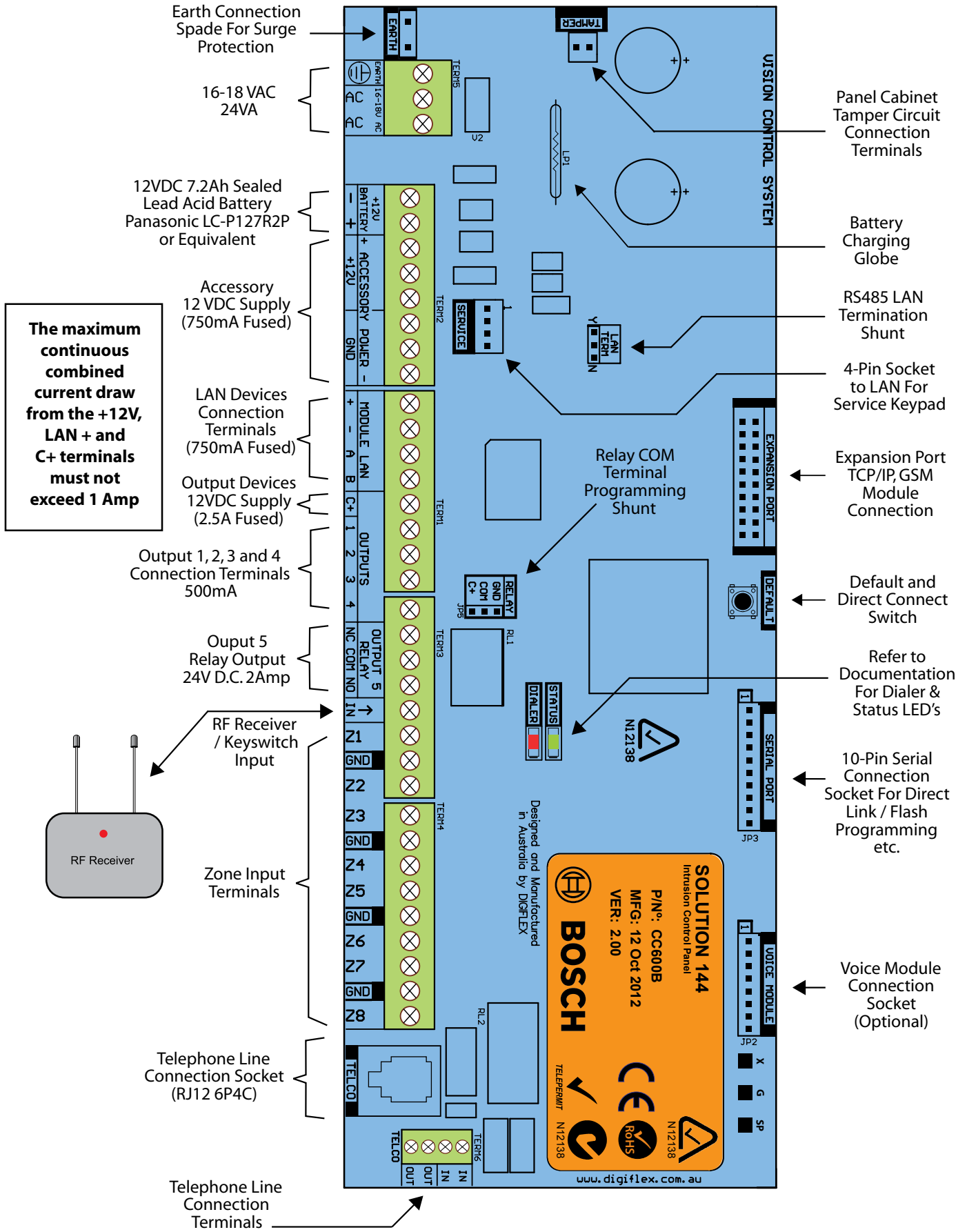


Figure 24: Terminal Descriptions

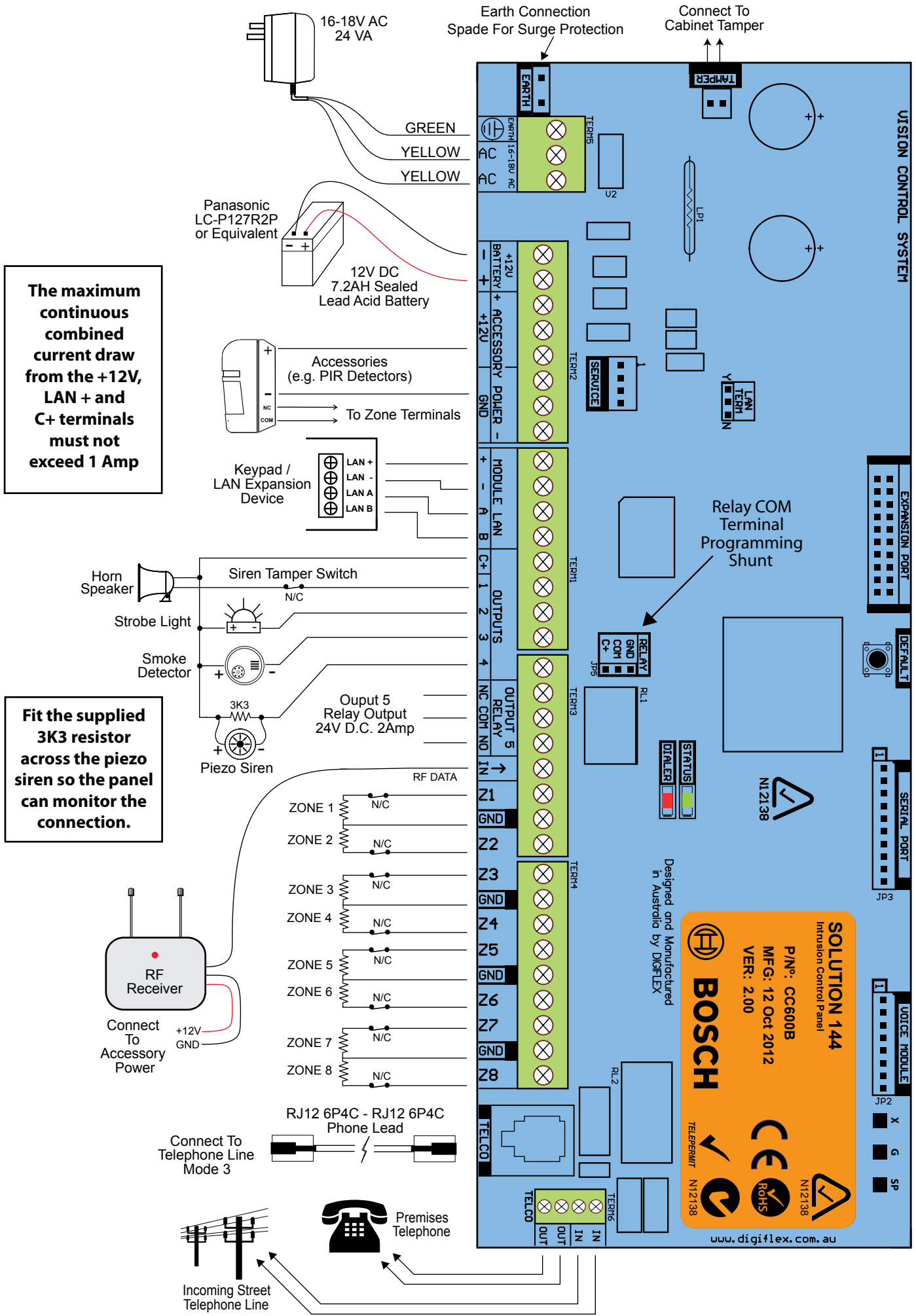
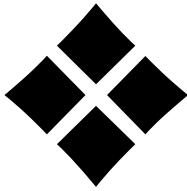


Figure 25: Wiring Diagram



# Programming Overview

The control panel incorporates a menu text driven interface. This interface is very similar to that found on many mobile phones. Once programming mode is entered you will see a number of menu options in the display and these may vary depending in the user authority level.

## ENTERING PROGRAMMING MODE

To enter installer program mode, enter PIN + [MENU].

**The default Installer PIN is 1234.**

The Red and Green LED indicators on the keypad will flash to confirm Installer programming mode is active.

## EXITING PROGRAMMING MODE

Press and hold down the [MENU] key for 2 seconds.

The system will scan all timezones and perform the functions relative to the current system. For example if a timed output should be operated then it will operate and if the system should be armed it will arm.



*You can also select Exit and press [OK] from each menu level.*

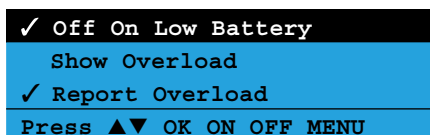
## COMMAND MENUS

When you first enter programming mode, a special menu called the 'Command Menu' will appear at the top of the menu tree. The command menu provides a list of the most common system functions like "Turn Chime Mode On", "Move To An Area" or "Turn An Area On".

Use the up and down arrow keys to navigate and press [OK] to select the command required.

## PROGRAMMING OPTION BIT MENUS

Use the up and down arrow keys to scroll through the 8 different options. To enable an option, press the [ON] key – a tick will be displayed. To disable an option, press the [OFF] key.



To save programming changes, press [OK] or press [MENU] to exit without saving.

## NAVIGATING THE MENU

Using the up and down arrow keys to navigate, locate the desired menu item using the highlight bar and then press the [OK] key to select.

A new list of menu items will appear. Repeat the above until the desired menu item is located.

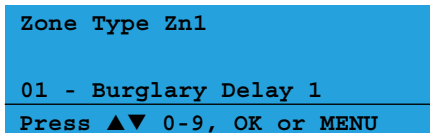
To navigate backwards through the menu items press the [MENU] key at any time. Alternatively if you know the direct menu item number press [MENU] + Item Number.

Key	Description
←	Scrolls Cursor Left
→	Scrolls Cursor Right
↑	Scrolls Cursor Up
↓	Scrolls Cursor Down
<b>OK</b>	Enter Menu Options or Saves Changes
<b>MENU</b>	Go Back One Level, Abort Current Change or Hold Down to Exit Programming Mode
<b>0 to 9</b>	Enter Data Value
<b>ON</b>	Turn On Bit Option
<b>OFF</b>	Turn Off Bit Option, Clear to End of Line

Table 12: Keys Used During Programming

## LIST OPTIONS

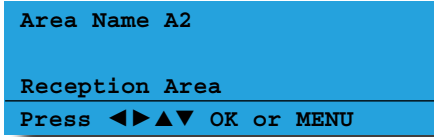
Use the up and down arrow keys to step through the available options. Press [OK] to save or [MENU] to exit without saving.



*You can also enter the option number directly followed by [OK]. You must press the [OK] a second time to confirm the current setting.*

### ALPHA TEXT

Text descriptions are available for Area Name, Zone Name, User Name, TimeZone Name, Holiday Name, Keypad/Reader Name and Output Name. Each name can have a maximum of 20 characters.



When programming text, each numeric key represents a different group of characters.

Pressing the same numeric key repeatedly will step you through the available characters assigned to the key. The text key layout is the same as most phones. Refer to the table below for detailed character information.

Key	Characters Assigned To Each Numeric Key									
1	.	,	?	!	-	&	`	1		
2	A	B	C	a	b	c	2			
3	D	E	F	d	e	f	3			
4	G	H	I	g	h	i	4			
5	J	K	L	j	k	l	5			
6	M	N	O	m	n	o	6			
7	P	Q	R	S	p	q	r	s	7	
8	T	U	V	t	u	v	8			
9	W	X	Y	Z	w	x	y	z	9	
0	SPACE	0								
↑	Scroll Up through entire character list									
↓	Scroll Down through entire character list									
←	Move to left one character position									
→	Move to right one character position									
OFF	Clear from cursor position to end of line									

Table 13: Text Keypad Character Set

Once the desired character is displayed press the right arrow key to move to the next character position.

To save programming changes, press [OK] or press [MENU] to exit without saving.



The following additional special characters are available by scrolling using the up and down arrow keys.

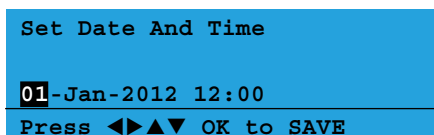
+ - @ # \$ " & % \* : ( ) / < > =

### CLOCK PROGRAMMING

Use the left and right arrow keys to move to the field and use the up and down keys to change. Press [OK] to save or [MENU] to exit without saving.



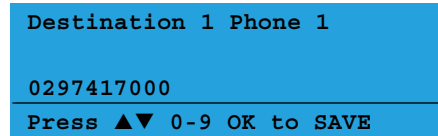
The time is set using a 24 hour clock.



### TELEPHONE NUMBERS

To program, select primary telephone number under MENU 5-1-1 then enter the digits of the telephone number and press the [OK] key to save.

Use the up and down arrow keys to program special characters (\*, # and Pause).



Key	Characters Assigned To Each Numeric Key
0 to 9	Enter the digits 0 to 9
↑ ↓	Scroll Up through entire character list 0 - 9 • # , comma = 2 second pause
← →	Move to left or right one character position
OFF	Clear from cursor position to end of line

Table 14: Phone Number Character Set

To save programming changes, press [OK] or press [MENU] to exit without saving.

### GETTING STARTED BACK TO BASE

The following steps are the minimum requirements to get the system reporting back to base. Examples assume the panel is disarmed with no alarms and starting from the factory default settings.

- 1) Enter programming mode.  
[1][2][3][4] + [MENU]
- 2) Set date and time.  
MENU 7-1-0
- 3) Change default installer PIN.  
MENU 1-5-2
- 4) Change default master PIN.  
MENU 1-1-1
- 5) Enter (client) account number for Area 1.  
MENU 2-2-0
- 6) Enter base station primary telephone number.  
MENU 5-1-1
- 7) Enter base station secondary telephone number.  
MENU 5-1-2
- 8) Press and hold down [MENU] to exit.



## SERVICE MODE

Service mode when activated disables dialler reporting, prevents all alarms and prevents all users from arming the system.

### Turning Service Mode ON

- 1) Enter programming mode.  
[1][2][3][4] + [MENU]
- 2) Turn service mode on.  
[MENU] [7][0][8]
- 3) Follow display prompts.
- 4) Hold down [MENU] to exit.



Keypads will display the word "SERVICE" in the middle of the display when service mode is active.

### Turning Service Mode OFF

- 1) Enter programming mode.  
[1][2][3][4] + [MENU]
- 2) Turn service mode on.  
[MENU] [7][0][8]
- 3) Follow display prompts.
- 4) Hold down [MENU] to exit.



You must exit Service Mode to reactivate the system. Service mode will automatically exit after 2 hours.

## DEFAULTING THE SYSTEM

Defaulting the system will reset all programming options back to the factory default setting. All programming information will be erased.

### Hardware Default

- 1) Remove all power to the system - AC and battery.
- 2) Press and hold the default push button, then apply power to the control panel.
- 3) Release the default button, The panel will reset and revert to normal operation when default is complete.

### Software Default

- 1) Enter programming mode.  
[1][2][3][4] + [MENU]
- 2) Select factory default option.  
MENU 7-0-4
- 3) The panel will reset and revert to normal operation when the default is complete.



You can disable factory defaulting using MENU 7-7-4. If factory defaulting has been disabled you must know the installer PIN to perform a factory default otherwise the system will need to be returned to your supplier for defaulting or you can purchase a CM255B Default Unlock Key which will unlock the panel in the field. Charges will apply for defaulting if returned to the distributor.

## TRIGGERING A DURESS ALARM

If your PIN is 2580, to send a duress report when the area is off, Enter, [2][5][8][0] + [8][0] + [OK] or [ON].

If your PIN is 2580, to send a duress report when the area is on, Enter, [2][5][8][0] + [8][0] + [OFF].



Duress alarms are triggered by entering the user PIN followed by the last 2 digits of the user PIN followed by the ON or OFF key.

## DOMESTIC TEMPLATE DEFAULTS

The following table lists the changes that will occur when you select domestic default. See MENU 7-0-3 — Domestic Default.

Program Option	Domestic Default Value
All Trouble Reports	Disabled
All Bypass Reports	Disabled
All Restore Reports	Disabled
Destination 1 TX Format	Domestic Reporting
Access Route	Log Only
Open / Close Reports	Log Only
Test Route	Log Only
System Route	Log Only

Table 15: Domestic Reporting Defaults

## DIRECT LINK PROGRAMMING

The panel can be programmed via the Solution Link™ Upload/Download software in either Direct Link or Remote Link modes. For Direct Link you will need a CM900 Direct Link module which is used to connect the panels serial port to the PC.

Once the cable is connected you will need to hold down the default switch on the panel for 5 seconds to initiate the programming session. See the board layout drawings in Section 3 of this manual for the default switch location.

## ZONE ARRAY

The feature allows you to view the condition of all zones on the panel in banks of 16 zones at a time. From the installer programming mode press MENU 3-0-1 to access the zone array.

Use the [↑] and [↓] arrow keys to scroll up and down the zone banks and press [OK] or [MENU] when finished.

The following information can be displayed depending on the current zone status.

**N** = NORMAL  
**S** = SHORTED  
**A** = ALARM  
**T** = TAMPER  
 - = DISABLED

```
0000000001111111
1234567890123456
NSA-ANAT-----
Press ▲▼ OK or MENU
```

In the above example screen,

**N** = Zone 01 and 06 are Normal (Sealed)  
**S** = Zone 02 is Shorted  
**A** = Zone 03,05,07 are in Alarm (Unsealed)  
**T** = Zone 08 is in Tamper Alarm (Unsealed)  
 - = Zone 04, 09-16 are Disabled (Unused)

## OUTPUT ARRAY

This feature allows you to view output status in groups of 16. From the installer programming mode press MENU 4-0-2 to access the output array.

Use the [↑] and [↓] arrow keys to scroll up and down the output banks and press [OK] or [MENU] when finished.

The following information can be displayed depending on the current zone status.

**N** = NORMAL - Off Condition  
**T** = TRIGGERED - On Condition  
**F** = FAULT - Overload Condition  
 - = DISABLED

- 1) Enter [MENU] + [4] + [0] + [2] and use the up and down arrows to select the output group to view.
- 2) Use the up and down arrows at any time to move to a new group. The keypad will display the following output array information for outputs 1 to 16.

```
0000000001111111
1234567890123456
NNNNN---TF-----
Press ▲▼ OK or MENU
```

In the above example screen,

**N** = Outputs 01 to 05 are Normal (Off)  
**F** = Output 10 has a Fault (Overload)  
**T** = Output 09 is Triggered (On)

- = Outputs 05 to 08 and Outputs 11 to 16 are Disabled or Not Available

## DOOR ARRAY

This feature allows you to view door status in groups of 16. From the installer programming mode press MENU 4-0-4 to access the output array.

Press [OK] or [MENU] when finished.

The following information can be displayed depending on the current zone status.

**L** = Door Locked  
**U** = Door Unlocked  
**O** = Override  
 - = Disabled or Not Available

```
0000000001111111
1234567890123456
LLLLL---UUUUO---
Press ▲▼ OK or MENU
```

In the above example screen,

**L** = Doors 01 to 05 are Locked  
**O** = Door 13 has a Override condition  
**U** = Doors 09 to 12 area Unlocked  
 - = Doors 06 to 08 and Doors 14 to 16 are Disabled or Not Available

## TESTING THE SYSTEM

You will need to be in programming mode before accessing the test functions listed below.

### Walk Test

Use the walk test command MENU 3-9-0 to test and verify that all zones work correctly.

### External Audible Test

Use MENU 4-9-0 to test and verify that all horn speakers operate. This test will sound the horn speaker for two seconds.

### Internal Audible Test

Use MENU 4-9-1 to test and verify that all 12 VDC sirens operate. This test will sound the siren for two seconds.

### Strobe Test

Use MENU 4-9-2 to test and verify that the strobe operates. This test will turn on the strobe until you manually stop the test.

### Battery Test

Use MENU 7-9-1 to test the back-up battery that is connected to the control panel.

### Communication Test

Use MENU 5-9-0 to test the telephone reporting capability of the control panel. You can also activate a communication test by holding down the Test / Mail key on the keypad.

**BASIC REPORTING REFERENCE**

The following table is a shortform point ID listing.

For a complete listing of all the Contact ID and SIA event reporting information that will be sent by the control panel you will need to view the base station template document that is included on the Solution Link CD or contact your distributor.

<b>Zn921 - 928</b>	LAN Isolator 9 - 16
<b>Zn931 - 938</b>	LAN Power Supply 9 - 16
<b>Zn951 - 958</b>	Output Expander 9 - 16
<b>Zn971 - 978</b>	Consoles 9 - 16

*Table 16: Shortform Point ID Listing*

Point ID Table	Module Description
<b>Ur999</b>	Installer
<b>Ur998</b>	Remote User
<b>Ur997</b>	TimeZone
<b>Ur996</b>	Guard Tour
<b>Ur001 - 995</b>	Users
<b>Ur000</b>	Quick Arm
<b>Zn001 - 200</b>	Zones General
<b>Zn201 - 264</b>	Doors 1 - 64 or Zones 201 - 264
<b>Zn301 - 428</b>	User Keyfob 1-128
<b>Zn429 - 556</b>	User Keyfob 129 - 256
<b>Zn701 - 708</b>	Door Controller 1 - 8
<b>Zn711 - 718</b>	Door Controller 9 - 16
<b>Zn761 - 768</b>	Lift Controller 1 - 8
<b>Zn771 - 778</b>	Lift Controller 9 - 16
<b>Zn781 - 788</b>	Input Expander 1 - 8
<b>Zn791 - 798</b>	Input Expander 9 - 16
<b>Zn801 - 808</b>	Universal Expander 1 - 8
<b>Zn811 - 818</b>	Universal Expander 9 - 16
<b>Zn821 - 828</b>	RF Receiver 1 - 8
<b>Zn831 - 838</b>	LAN Power Supply 1 - 8
<b>Zn841 - 848</b>	Serial Expander 1 - 8
<b>Zn851 - 858</b>	Output Expander 1 - 8
<b>Zn860</b>	GSM Module
<b>Zn861</b>	GSM Input 1
<b>Zn862</b>	GSM Input 2
<b>Zn863</b>	GSM Input 3
<b>Zn864</b>	GSM Input 4
<b>Zn870</b>	Ethernet Module
<b>Zn871</b>	Real Time Clock Module
<b>Zn872</b>	Voice Module
<b>Zn873</b>	Service Keypad
<b>Zn881 - 888</b>	Consoles 1 - 8
<b>Zn891 - 898</b>	Control Panel 1 - 8
<b>Zn911 - 918</b>	LAN Isolator 1 - 8
<b>Zn921 - 928</b>	LAN Isolator 9 - 16
<b>Zn901 - 908</b>	Destination Route 1 - 8
<b>Zn971 - 978</b>	Consoles 9 - 16
<b>Zn901 - 908</b>	Destination Route 1 - 8
<b>Zn911 - 918</b>	LAN Isolator 1 - 8

## DTMF CONTROL FUNCTIONS

Firmware includes comprehensive DTMF control of individual areas and outputs with full user PIN and TIMER GROUP access verification.

Unlike other systems, no additional hardware or modules are required for DTMF control. To configure the desired functions see MENU 5-3-5 DTMF Options.

### How to Use DTMF Control

- 1) **Once the panel answers the incoming call, if either option 1, 2, 3 or 4 in MENU 5-3-5 is enabled, then the panel will play a short welcome jingle. You now have approximately 5 seconds to enter a valid PIN and log onto the panel.**
- 2) **Enter PIN followed by the [#] key. If the PIN is valid the system will respond with two short beeps. If the PIN is invalid then a single long beep will be heard.** If a valid PIN is not entered in time, the panel will attempt to establish a modem connection as if connecting to the Solution Link software. If this happens you will need to hang up for approximately 60 seconds before trying again.
- 3) **Once validated, the following commands can be performed. See the table below. If no keys are pressed for 20 seconds then the panel will play the exit jingle before terminating the session and hanging up. Pressing [#][#] at any time while connected will cause the panel to terminate the session.**

DTMF CONTROL FUNCTIONS		
Operation	Command	Tone Response
Quick Arm All Areas	[0] + [#]	High, Medium, Low
Log In OK	[PIN] + [#]	Low, High
Error	Incorrect Entry	Long Beep
Turn Area ON	[1] + [Area N°] + [#] + [1]	Low, High
Turn Area OFF	[1] + [Area N°] + [#] + [2] + [#]	High, Low
Turn Output ON	[2] + [Output N°] + [#] + [1] + [#]	Low, High
Turn Output OFF	[2] + [Output N°] + [#] + [2] + [#]	High, Low
End Session	[#] + [#]	High, Medium, Low

Table 17: DTMF Remote Control Functions

## DTMF EXAMPLES

Each example below shows the log on step for clarity. In practise is only necessary to log on once per DTMF control session.

### To turn Area 1 ON enter the following

[2] [5] [8] [0] [#] = Log ON

[1] + [1] + [#] + [1] = Arm Area 1

### To turn Output 10 ON enter the following

[2] [5] [8] [0] [#] = Log ON

[2] + [1] [0] + [#] + [1] = Turn Output 10 ON

### To turn Output 12 OFF enter the following

[2] [5] [8] [0] [#] = Log ON

[2] + [1] [2] + [#] + [2] = Turn Output 12 OFF



If the DTMF Quick Arm option is enabled then it is possible to remotely arm all areas without logging onto the panel. Simply enter [0] + [#] following the welcome jingle.

Make sure that the phone being used to remotely control the panel is set to transmit DTMF tones when keys are pressed during the call. This option is disabled by default on some phones.

**MENU REFERENCE TABLE**

The control panel includes a simple text menu system which makes all levels of programming extremely easy. Once a valid PIN has been entered followed by the MENU key, the system will automatically determine which menus and options the PIN holder has access to and only those items will be displayed.

There are four basic grouping levels used. Throughout the manual, symbols have been placed near each menu option so that you can easily relate the authority level which is required to access them.

**A** = **A** = All (No PIN Required)

**U** = **U** = User PIN Has Access

**M** = **M** = Master PIN Has Access

**I** = **I** = Installer PIN Has Access

The following table lists all programming menus and the authority level required to access them.

<b>0</b>	<b>Commands</b>	<b>1</b>	<b>Access</b>	<b>2</b>	<b>Areas</b>
<b>UMI</b>	2-0-1 Turn Area On/Off	<b>1-0</b>	<b>Commands</b>	<b>2-0</b>	<b>Commands</b>
<b>UMI</b>	2-0-2 Turn All Areas On	<b>MI</b>	1-0-0 Erase User	<b>AUMI</b>	2-0-0 Area Status
<b>UMI</b>	2-0-3 Turn All Areas Off			<b>UMI</b>	2-0-1 Turn Area On/Off
<b>UMI</b>	2-0-4 Move To Area	<b>1-1</b>	<b>PIN Codes</b>	<b>UMI</b>	2-0-2 Turn All Areas On
<b>AUMI</b>	2-0-5 Chime On/Off	<b>UMI</b>	1-1-0 Change Own PIN	<b>UMI</b>	2-0-3 Turn All Areas Off
<b>UMI</b>	1-1-0 Change Own PIN	<b>MI</b>	1-1-1 Change Other PIN	<b>UMI</b>	2-0-4 Move To Area
<b>AUMI</b>	3-0-0 Zone Status	<b>MI</b>	1-1-2 Add PIN	<b>AUMI</b>	2-0-5 Chime On/Off
<b>AUMI</b>	4-0-0 Output Status	<b>MI</b>	1-1-3 Delete PIN	<b>MI</b>	2-0-6 Chime Mode
<b>UMI</b>	4-0-1 Turn Output On/Off	<b>I</b>	1-1-4 View PIN		
<b>MI</b>	7-1-0 Set Date And Time			<b>2-1</b>	<b>Area Properties</b>
<b>UMI</b>	3-0-5 Smoke Sensor Reset	<b>1-2</b>	<b>Token</b>	<b>MI</b>	2-1-0 Area Name
<b>UMI</b>	3-9-0 Walk Test All Zones	<b>MI</b>	1-2-0 Add Token	<b>I</b>	2-1-1 General Options
<b>MI</b>	4-9-0 External Siren Test	<b>MI</b>	1-2-1 Delete Token	<b>I</b>	2-1-2 Input Options
<b>MI</b>	4-9-1 Internal Siren Test	<b>MI</b>	1-2-2 Token Status	<b>I</b>	2-1-3 Output Options
<b>MI</b>	4-9-2 Strobe Test	<b>MI</b>	1-2-3 Edit Token	<b>I</b>	2-1-4 Reporting Options
<b>UMI</b>	5-0-1 Call/Answer RAS			<b>I</b>	2-1-5 Strobe Trigger
<b>UMI</b>	7-9-1 Battery Test	<b>1-3</b>	<b>RF Keyfob</b>	<b>MI</b>	2-1-6 Part Mode 1 Name
<b>UMI</b>	5-9-0 Test Dialler	<b>MI</b>	1-3-0 Add Keyfob	<b>MI</b>	2-1-7 Part Mode 2 Name
<b>I</b>	7-0-8 Service Mode	<b>MI</b>	1-3-1 Delete Keyfob	<b>MI</b>	2-1-8 Auto Arming
<b>UMI</b>	About	<b>I</b>	1-3-2 Test Keyfob		
		<b>1-4</b>	<b>User Properties</b>	<b>2-2</b>	<b>Reporting</b>
		<b>MI</b>	1-4-0 User Name	<b>I</b>	2-2-0 Account Dest 1
		<b>MI</b>	1-4-1 Area Assignment	<b>I</b>	2-2-1 Account Dest 2
		<b>MI</b>	1-4-2 User Options	<b>I</b>	2-2-2 Open Close Route
		<b>MI</b>	1-4-4 TimeZone Access		
		<b>MI</b>	1-4-5 Door Assignment	<b>2-8</b>	<b>Timers</b>
		<b>MI</b>	1-4-6 User Expire Date	<b>MI</b>	2-8-0 Exit Time
		<b>1-5</b>	<b>Global Properties</b>	<b>MI</b>	2-8-1 Entry Time 1
		<b>I</b>	1-5-0 PIN Length	<b>MI</b>	2-8-2 Entry Time 2
		<b>I</b>	1-5-1 PIN Retry Count	<b>MI</b>	2-8-3 Part Entry Time
		<b>I</b>	1-5-2 Installer PIN	<b>I</b>	2-8-4 Auto Arm Pre Alert
		<b>1-6</b>	<b>Reporting</b>	<b>I</b>	2-8-6 Senior Watch Time
		<b>I</b>	1-6-0 Access Route		
		<b>I</b>	1-6-1 Access Options	<b>2-9</b>	<b>Area Testing</b>
				<b>I</b>	2-9-0 Area Watch
		<b>1-8</b>	<b>Fingerprint</b>	<b>I</b>	2-9-1 User Test Interval
		<b>MI</b>	1-8-0 Add Fingerprint	<b>I</b>	2-9-2 Service Interval
		<b>MI</b>	1-8-1 Delete Fingerprint	<b>I</b>	2-9-3 Test Options
		<b>MI</b>	1-8-2 Fingerprint Status		

Table 18: Menu Reference Table

<b>3</b>	<b>Inputs</b>	<b>4</b>	<b>Outputs</b>	<b>5</b>	<b>Comms</b>
	<b>3-0 Commands</b>		<b>4-0 Commands</b>		<b>5-0 Commands</b>
<b>AUMI</b>	3-0-0 Zone Status	<b>AUMI</b>	4-0-0 Output Status	<b>UMI</b>	5-0-1 Call /Answer RAS
<b>MI</b>	3-0-1 Zone Array	<b>UMI</b>	4-0-1 Turn Output On/Off	<b>MI</b>	5-0-2 Call Forward On/Off
<b>UMI</b>	3-0-2 Bypass Zones	<b>MI</b>	4-0-2 Output Array	<b>MI</b>	5-0-3 Check Web Email
<b>MI</b>	3-0-3 Set Chime Zones	<b>MI</b>	4-0-3 Door Status	<b>MI</b>	5-0-4 Email System Log
<b>MI</b>	3-0-4 Set Part 2 Zones	<b>MI</b>	4-0-4 Door Array	<b>MI</b>	5-0-5 Start Direct Link
<b>UMI</b>	3-0-5 Smoke Sensor Reset	<b>MI</b>	4-0-5 Door Override	<b>MI</b>	5-0-6 Voice Setup
	<b>3-1 Zone Properties</b>		<b>4-1 Properties</b>	<b>MI</b>	5-0-8 Register Customer
<b>MI</b>	3-1-0 Zone Name	<b>MI</b>	4-1-0 Output Name	<b>I</b>	5-0-9 Register Installer
<b>I</b>	3-1-1 Zone Type	<b>I</b>	4-1-1 Event Type		<b>5-1 Telephone Numbers</b>
<b>I</b>	3-1-2 Area Assignment	<b>I</b>	4-1-2 Event Assignment	<b>I</b>	5-1-0 Number Prefix
<b>I</b>	3-1-3 Pulse Count	<b>I</b>	4-1-3 Output Polarity	<b>MI</b>	5-1-1 Destination 1
<b>I</b>	3-1-4 Pulse Count Time	<b>I</b>	4-1-4 Time Parameter	<b>MI</b>	5-1-2 Destination 2
<b>I</b>	3-1-5 Door Assignment	<b>I</b>	4-1-5 Output Options	<b>MI</b>	5-1-6 Call Forward On
<b>I</b>	3-1-6 Report Route		<b>4-2 Door Properties</b>	<b>MI</b>	5-1-7 Call Forward Off
<b>I</b>	3-1-7 Report Options	<b>MI</b>	4-2-0 Door Name		<b>5-2 Properties</b>
<b>I</b>	3-1-8 Zone Options	<b>I</b>	4-2-2 Unlock TimeZone	<b>I</b>	5-2-0 Call Attempt Count
	<b>3-3 RF Zone</b>	<b>I</b>	4-2-3 Door Options	<b>I</b>	5-2-1 Dialler Options
<b>I</b>	3-3-0 Add RF Device		<b>4-9 Output Testing</b>	<b>I</b>	5-2-2 Phone Line Options
<b>I</b>	3-3-1 Delete RF Device	<b>MI</b>	4-9-0 External Siren Test	<b>I</b>	5-2-3 Country
<b>I</b>	3-3-2 Test RF Device	<b>MI</b>	4-9-1 Internal Siren Test	<b>I</b>	5-2-7 Set SMS Password
	<b>3-4 Global Input Options</b>	<b>MI</b>	4-9-2 Strobe Test		<b>5-3 Remote Access</b>
<b>I</b>	3-4-0 EOL Value	<b>MI</b>	4-9-3 Fire Siren Test	<b>I</b>	5-3-0 Call Back Number
<b>I</b>	3-4-1 Keyswitch Options			<b>I</b>	5-3-1 RAS Security PIN
<b>I</b>	3-4-2 Input Options			<b>I</b>	5-3-2 Log Threshold
	<b>3-5 PGM Input</b>			<b>I</b>	5-3-3 Ring Count
<b>I</b>	3-5-0 Input Type			<b>I</b>	5-3-4 RAS Options
	<b>3-6 Tamper Inputs</b>			<b>I</b>	5-3-5 DTMF Options
<b>I</b>	3-6-0 Tamper Options			<b>I</b>	5-3-6 Voice Access Code
	<b>3-9 Input Testing</b>			<b>I</b>	5-3-7 CLI Numbers
<b>UMI</b>	3-9-0 Walk Test All Zones			<b>I</b>	5-3-8 User RAS PIN
<b>UMI</b>	3-9-1 Walk Test A Zone				<b>5-4 Reporting</b>
<b>I</b>	3-9-2 Sensor Watch Time			<b>I</b>	5-4-0 TX Format Dest 1
				<b>I</b>	5-4-1 TX Format Dest 2
				<b>I</b>	5-4-2 Test Route
				<b>I</b>	5-4-3 System Route
				<b>I</b>	5-4-4 Emergency Route
				<b>I</b>	5-4-5 Swinger Dialler
				<b>I</b>	5-4-6 Burg Report Delay
				<b>I</b>	5-4-7 Fire Report Delay
					<b>5-5 MyAlarm</b>
				<b>I</b>	5-5-0 IP Address
				<b>I</b>	5-5-1 IP Port
				<b>I</b>	5-5-2 MyAlarm Options
				<b>I</b>	5-5-7 Gateway Numbers
				<b>MI</b>	5-5-8 Email Address
				<b>MI</b>	5-5-9 Email Options

	<b>5-6 IP Reporting</b>	<b>6 Devices</b>	<b>7 System</b>
I	5-6-0 Receiver IP	<b>6-0 Commands</b>	<b>7-0 Commands</b>
I	5-6-1 Receiver Port	<b>UMI</b> 6-0-0 Device Status	<b>UMI</b> 7-0-0 Panel Status
I	5-6-2 Poll Rate	I 6-0-1 LAN Secure	<b>UMI</b> 7-0-1 System Trouble
I	5-6-3 ACK Wait Time	I 6-0-2 LAN Scan	<b>UMI</b> 7-0-2 History Log
I	5-6-4 IP Format	I 6-0-3 LAN Watch	I 7-0-3 Domestic Default
I	5-6-5 Retry Count	<b>MI</b> 6-0-7 Keypad Volume	I 7-0-4 Factory Default
I	5-6-6 Encryption Key	<b>MI</b> 6-0-8 Keypad Contrast	I 7-0-5 Template Default
I	5-6-7 Conettix NNC	<b>MI</b> 6-0-9 Keypad Backlight	<b>MI</b> 7-0-6 TimeZone Array
I	5-6-8 SIA IP Prefix		I 7-0-8 Service Mode
I	5-6-9 User Name/Password	<b>6-1 Keypads &amp; Readers</b>	
	<b>5-7 IP Remote Access</b>	<b>MI</b> 6-1-0 Name	<b>7-1 Clock</b>
<b>MI</b>	5-7-0 IP Address	I 6-1-2 Area Options	<b>MI</b> 7-1-0 Set Date And Time
<b>MI</b>	5-7-1 IP Port	I 6-1-3 Home Area	I 7-1-1 Summertime On
I	5-7-2 IP RAS Options	I 6-1-4 General Options	I 7-1-2 Summertime Off
I	5-7-3 RAS Lockout Time	I 6-1-5 Indicator Options	I 7-1-3 Locale
I	5-7-5 IPRS Address	I 6-1-6 Emergency Keys	
I	5-7-6 IPRS Port	I 6-1-7 Door Assignment	<b>7-3 Power</b>
	<b>5-9 Comms Test</b>	I 6-1-8 Lockout Time	I 7-3-0 AC Options
<b>UMI</b>	5-9-0 Send Test Report	<b>6-2 RF Devices</b>	I 7-3-1 Battery Options
I	5-9-1 Test Report Time	I 6-2-0 Receiver Options	I 7-3-2 Fuse Options
I	5-9-2 Test Report Period	I 6-2-1 Supervision Time	
I	5-9-3 Test Report Options	I 6-2-2 RF Device Options	<b>7-4 Siren</b>
I	5-9-4 Test Route	I 6-2-3 Add RF Keypad	I 7-4-0 Tone
I	5-9-5 Dial Number Test	I 6-2-4 Delete RF Keypad	I 7-4-1 Speed
		I 6-2-5 View RF Device ID	<b>MI</b> 7-4-2 Volume
			I 7-4-3 Siren Swinger
		<b>6-3 Serial Device</b>	
		I 6-3-0 Device Type	<b>7-5 TimeZones</b>
		I 6-3-1 Baud Rate	<b>MI</b> 7-5-0 Name
		I 6-3-2 Flow Control	<b>MI</b> 7-5-1 Time
			<b>MI</b> 7-5-2 Day
		<b>6-5 GSM/GPRS</b>	<b>MI</b> 7-5-3 TimeZone Options
<b>MI</b>	6-5-0 GSM/GPRS Status	<b>MI</b> 6-5-0 GSM/GPRS Status	
I	6-5-1 GSM/GPRS Options	I 6-5-1 GSM/GPRS Options	<b>7-6 Holidays</b>
<b>MI</b>	6-5-5 CLI Trigger Table 1	<b>MI</b> 6-5-5 CLI Trigger Table 1	<b>MI</b> 7-6-0 Holiday Name
<b>MI</b>	6-5-6 CLI Trigger Table 2	<b>MI</b> 6-5-6 CLI Trigger Table 2	<b>MI</b> 7-6-1 Start Stop Dates
<b>MI</b>	6-5-7 SMS Control	<b>MI</b> 6-5-7 SMS Control	
	<b>6-6 Ethernet Module</b>		<b>7-7 System Options</b>
I	6-6-0 Module IP Address		I 7-7-0 General Options
I	6-6-1 Subnet Mask		I 7-7-1 Area Options
I	6-6-2 Default Gateway		I 7-7-2 Keypad Idle Screen
I	6-6-3 Module MAC Address		<b>MI</b> 7-7-3 Keypad Hi/Lo Temp
I	6-6-9 Ethernet Options		I 7-7-4 Installer Options
			I 7-7-5 Language
			<b>MI</b> 7-7-7 Site Name
			<b>7-9 System Testing</b>
			<b>UMI</b> 7-9-0 Walk Test All Zones
			<b>UMI</b> 7-9-1 Battery Test

## BASIC SYSTEM OPERATION

### TURNING AN AREA ALL ON

Use this function to turn an area All On. The control panel is factory default only for one area. As soon as you turn an area on, exit time will start. Exit time allows you to exit the premises without sounding an alarm. The security installer or a master PIN user can program the length of exit delay time.

- 1) **Make sure that all zones are normal (not faulted).**
- 2) **Enter your PIN, then press the [ON] key.** If your PIN is valid and if all zones are normal, exit delay time will start. You should leave now. If your control panel detects a faulted zone, you should return it to normal, or bypass the zone. During exit delay, you may stop the area from turning on by entering your PIN followed by the [OFF] key.

### TURNING AN AREA PART ON / PART 2 ON

Use this function to turn an area Part On or Part 2 On. The control panel is factory default only for one area. Part On and Part 2 On turns on only part of the area, leaving the rest of the area turned off.

Only the security company can program which zones are monitored for Part On. A master user can program which zones are monitored when a user turns an area Part 2 On.

Once you have turned an area Part On or Part 2 On, exit delay time starts to count down. You should leave all zones that are active before exit delay time expires. Leaving active zones after exit delay expires causes an alarm event. Use Part On or Part 2 On only when you want part of an area turned on.

- 1) **Make sure that all zones are normal (not faulted).**
- 2) **Enter your PIN, then press the [PART] key.** If your PIN is valid and if all zones are normal, the keypad will prompt you to select Part On or Part 2 On.
- 3) **Using the arrow keys, highlight Part On or Part 2 On then press [OK].** Exit delay time will start. You should leave now. If your system has a faulted zone, you should return it to normal, or bypass the faulted zone. During exit delay, you may stop the system from turning Part On by entering your PIN followed by the [OFF] key.
- 4) **When exit time has expired, the keypad will display the Part On icon.**



*If you wish to cancel the exit delay time when turning the area Part On/Part 2 On, press the [PART] key once during the exit delay time.*

### TURNING AN AREA OFF

When the system is on, you must enter through a designated entry door to prevent an alarm. Opening a designated door (e.g. front door) will start entry time. During entry time, the keypad will sound the Hi/Lo tone to remind you to turn the area off. To turn the area off, enter your PIN followed by the [OFF] key before the entry delay time expires.

If you enter through the wrong door or fail to turn the system off before the entry delay time expires, you may sound an alarm. If an alarm occurs, silence the alarm (by entering your PIN followed by the [OFF] key) and call your security company to let them know that it is not an emergency situation.

- 1) **Enter your PIN + [OFF] to turn the system (or area) off. The keypad will no longer display the 'Lock' or 'Part' icons.**

### SILENCING ALARMS

When the control panel has registered an alarm, the keypad (s) and sirens will sound to alert personnel that an alarm occurred. The keypad will scroll all alarms on the keypad display for visual feedback. If you enter your PIN before the system dials your security company, the alarm report is cancelled (if programmed).

- 1) **Enter your PIN + [OFF] to silence any alarm and turn the system off.** The keypad will continue to scroll all alarm events that caused the alarm. This is called alarm memory.
- 2) **To clear alarm memory, turn the area on and off again (eg. PIN + [ON] + PIN + [OFF]).**

### AUTOMATIC ARMING

Your system may have been programmed to automatically turn one or more areas All On at a certain time of the day.

If for some reason you are still in the building when the auto arming is taking place, it is possible to delay the auto-on time (automatic arming time) by one hour simply by entering your PIN during the auto-on pre-alert time. The auto-on pre-alert time sounds the keypad buzzer to warn you that the system will automatically turn All On.

#### Example:

If the control panel is programmed by your installer to automatically turn All On at 6:00pm and the auto-on pre-alert time starts beeping the keypad at 5:55pm, entering your PIN between 5:55pm and 6:00pm will delay the auto-on time by one hour and the auto-on pre-alert time will again commence at 6:55pm. Therefore the system will automatically turn All On at 7:00pm.



### REMOTE ARMING - QUICK ARM

If you forget to turn your system on, it may be possible for you to remotely turn on your system using a touch tone telephone if the remote arm option has been enabled by your installer.

To remotely turn on your system, call the telephone number that the control panel is connected to. When the control panel answers the call, you will here 3 beeps in ascending frequency if the control panel is disarmed. To turn on your control panel, press [0] + [#] on your touch tone telephone. You will hear 3 beeps in descending order when the panel arms.

All areas on the system will be turned All On regardless of there condition when using the DTMF quick arm function.

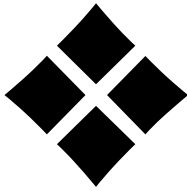
### DURESS OR SILENT ALARMS

A duress emergency alarm can be easily initiated via the keypad if you are being forced to operate the system against your will.

To initiate a duress emergency, enter your normal user PIN followed by the last 2 digits of your PIN followed by the ON or OFF key. See the following examples.

- 1) **If your PIN is 2580, to send a duress report when the area is off, enter, [2] [5] [8] [0] + [8] [0] + [OK] or [ON].**
- 2) **If your PIN is 2580, to send a duress report when the area is on, enter, [2] [5] [8] [0] + [8] [0] + [OFF].**





# Access Programming

The control panel has a total of 255 users that can operate the system using a PIN, token, RF Keyfob or fingerprint. A maximum of 16 LAN devices which comprise of keypads that have built-in prox readers, LAN readers and fingerprint readers can be used to operate the system.

Each user name can have up to 20 characters to identify the user within the system and to present a greeting message when operating the system. User PIN's can be configured for 1 to 8 digits or variable where users can have different pin lengths up to 8 digits long. All users have options which can be set to control their authority level within the system, whether they are allowed to bypass zones or send 'open' and 'close' reports see MENU 1-4-2 — User Options.

The installer Ur999 is a special user within the system and has ultimate privileges which can not be changed. The Installer PIN can arm or disarm the system and has access to all menus at all times. This is a very powerful user pin and should be treated with utmost respect so that it is not widely known.

## TimeZone Access

Users can belong to a timezone that determines whether or not the user is allowed access to the system. To create a timezone, you will need to setup a timezone with start and stop times, including the days of the week and then set the user to follow that timezone. Each user that you require to be restricted is then assigned to the timezone you selected.

Each timezone have up to 4 different start/stop periods that can be used to create multiple access times and holidays can also be linked with timezones.

### Example:

**Restricting access to only Monday to Friday 8am to 10pm.**

- 1) Pick a timezone access number between 2-16, lets say 5.
- 2) Setup timezone 5 start time 8am, stop time 10pm, days MTWTF.
- 3) Assign each restricted user to timezone access 5.

## TimeZones

Timezones determine the valid operating times and days and then users which are to be restricted are then assigned to the timezone.

## Door Assignment

A user can be restricted to certain doors within a building and this is done by assigning the user to one or more doors. When a user presents their token to a proximity reader, the user parameters are checked and if the user has a matching door assignment to the reader door assignment, then access is granted.

The output used to operate the door strike will also need to be assigned to the same door number so that it operates at the same time. To restrict a user from accessing doors outside specified times, create a timezone and assign the user timezone to the same timezone.

### Example:

**Prox reader operating a door.**

- 1) Assign proximity reader 9 to a door 1 to 16, say 4.
- 2) Set an output event type = door and Index = 4.
- 3) Assign user to door 4, a user can belong to multiple doors.
- 4) Assign reader to area 0 and disable arm/disarm options.
- 5) Present token to reader to access door.

### Example:

**Prox reader operating door and disarm Area 1.**

- 1) Assign proximity reader 9 to a door 1-16, say 4.
- 2) Set an output event type = door and index = 4.
- 3) Assign user to door assignment 4, a user can belong to multiple doors.
- 4) Assign reader to area 1, enable disarming option.
- 5) Present token to reader to disarm, present token again to release door.

**Example:****Prox reader operating door and arm/disarm Area 1.**

- 1) Assign proximity reader 9 to a door assignment 1 - 16, say 4.
- 2) Set an output event type = door and index = 4.
- 3) Assign user to door 4, a user can belong to multiple doors.
- 4) Assign reader to area 1, enable arming/disarming and badging options.
- 5) Present token to disarm, present token to release door, present token 3 times to arm Area 1.

**USER DEFAULT TABLE**

Parameter	User 1	User 2 - 255
Add PIN	2580	
Name	User 1	User 2 - 255
Area Assignment	1	1
User Options		
Master User	Y	
Reserved		
Arm Only		
Can Bypass	Y	Y
Auto Bypass Allowed	Y	Y
Always Report Op/Cl	Y	Y
Reserved		
Reserved		
TimeZone Access		
Door Assignment		

*Table 19: User Default Programming Options*

**USER PINS**

At factory default, each PIN is set to 4 digits in length. The default PIN for User 1 (master user) is 2580. Only the installer can change the PIN length - see MENU 1-5-0 — PIN Length.

Access > Commands >

Erase User



MENU 1-0-0

This menu allows the installer or master user, to erase another user. When a user is erased, it will return back to factory default all information relating to the following:

- ❖ PIN
- ❖ Token ID
- ❖ RF Keyfob ID
- ❖ Fingerprint ID
- ❖ Name
- ❖ TimeZone Access
- ❖ Door Assignment
- ❖ Area Assignment

- 1) Enter [MENU] + [1] + [0] + [0].
- 2) Use the arrow keys to highlight the user to be erased then press [OK].

```
Ur1 John Smith
Ur2 Debbie Smith
Ur3 User 3 Name
Press ▲▼ OK or MENU
```

- 3) Verify the user name to be erased and press [OK]. To abort press [MENU].

```
To erase Ur1
John Smith
press OK.
Press OK or MENU
```

Access &gt; PIN Codes &gt;

**Change Own PIN****I - M - U** MENU 1-1-0

This menu allows a user to change their own PIN. The new PIN should have the same number of digits as the old PIN, unless the installer has programmed the PIN length as variable. See MENU 1-5-0 - PIN length.

- 1) Enter [MENU] + [1] + [1] + [0]. The keypad will prompt you to enter a new PIN.

```
Enter New PIN For Ur2
Debbie Smith
-----
Press OK or MENU
```

- 2) Enter the new PIN, then press [OK]. If the error message 'PIN Not Allowed' is displayed, press [OK] and try a different PIN.
- 3) The keypad will now prompt you to confirm the new PIN again.

```
Confirm New PIN Ur2
Debbie Smith
****
-----
Press OK or MENU
```



*If you attempt to enter a new PIN that has already been programmed for another user, the system will display 'PIN Not Allowed'. The next time the original PIN holder disarms the system they will be notified that their PIN has been compromised. The compromised PIN message will continue to be displayed until one of the users that have the same PIN changes their PIN to be different.*

- 2) Enter the new PIN, then press [OK]. If the error message 'PIN Not Allowed' is displayed, press [OK] and try a different PIN.

```
Enter PIN For Ur3
Debbie Smith
-----
Press OK or MENU
```



*If you attempt to enter a new PIN that has already been programmed for another user, the system will display 'PIN Not Allowed'. The next time the original PIN holder disarms the system they will be notified that their PIN has been compromised. The compromised PIN message will continue to be displayed until one of the users that have the same PIN changes their PIN to be different.*

Access &gt; PIN Codes &gt;

**Change Other PIN****I - M** MENU 1-1-1

This menu allows the Installer or master user to change the PIN of other user's. The master user can only change PINs for other users in the same area.

The new PIN should have the same number of digits as the old PIN, unless the installer has programmed the PIN length as variable. See MENU 1-5-0 - PIN length.

- 1) Enter [MENU] + [1] + [1] + [1] and use the up and down arrows to highlight the user in the list then press [OK]. The system will only list users that can be changed.

```
Ur1 John Smith
Ur2 Debbie Smith
Ur3 User 3 Name
-----
Press ▲▼ OK or MENU
```

## Access &gt; PIN Codes &gt;

## Add PIN

I-M MENU 1-1-2

This menu allows the installer or master users the ability to add a PIN to another user. A master user can only add a PIN for users that have been assigned to the same area(s).

- 1) Press [MENU] + [1] + [1] + [2] and use the up and down arrows to highlight the user in the list then press [OK]. The system will only list users that can be added.

```
Ur2 Debbie Smith
Ur3 User 3 Name
Ur4 User 4 Name
Press ▲▼ OK or MENU
```

- 2) Enter the new PIN, then press [OK] to save.

```
Enter New PIN For Ur2
Debbie Smith
Press OK or MENU
```

## Access &gt; PIN Codes &gt;

## Delete PIN

I-M MENU 1-1-3

This menu allows the installer or master users the ability to delete another users PIN. A master user can only delete a PIN for users that have been assigned to the same area(s). The installer and master user cannot delete their own PIN.

- 1) Press [MENU] + [1] + [1] + [3] and use the up and down arrows to highlight the user in the list then press [OK]. The system will only list users that can be deleted.

```
Ur1 John Smith
Ur2 Debbie Smith
Ur3 User 3 Name
Press ▲▼ OK or MENU
```

- 2) Press [OK] to delete the PIN or press [MENU] to cancel.

```
Press OK To Delete PIN
For Ur2
Debbie Smith
Press OK or MENU
```

## Access &gt; PIN Codes &gt;

## View PIN

I-M MENU 1-1-4

This menu allows the installer to view and verify the PIN for any user.

- 1) Press [MENU] + [1] + [1] + [4] and use the up and down arrows to highlight the user in the list, then press [OK].

```
Ur1 John Smith
Ur2 Debbie Smith
Ur3 User 3 Name
Press ▲▼ OK or MENU
```

- 2) The keypad will display the current PIN of the user selected.

```
View PIN Ur1
2580
Press OK to SAVE
```

- 3) Press [OK] to save and exit or press [MENU] to exit without saving.

## USER TOKENS

This section outlines how to add and delete tokens. Users 1 to 255 can have a token assigned. Tokens provide an alternate method for users to turn the system on and off or to operate a door strike.

A token is a plastic card that has a unique ID number. Each user can be assigned a PIN as well as a token for greater flexibility.

A token can be presented to a keypad with a built in reader or to an external LAN reader module to operate the system. Tokens will follow all user settings.

## Access &gt; Token &gt;

## Add Token

I-M MENU 1-2-0

This menu allows the installer or master user to assign a token ID to each user. Only one token can be assigned to each user. To change a token for an existing user you will need to first delete the old token before you add the new one. See MENU 1-2-1 — Delete Token

- 1) Enter [MENU] + [1] + [2] + [0] and use the up and down arrows to highlight the user in the list then press [OK]. The keypad will only list users that dont already have tokens assigned.

```
Ur1 John Smith
Ur2 Debbie Smith
Ur3 User 3 Name
Press ▲▼ OK or MENU
```

- 2) Swipe the token card past the reader. As you swipe the token, the reader will sound a single beep to confirm that the token has been learnt.

```
To add token for Ur1
John Smith present new
token
Press OK or MENU
```



If the Add Token command is initiated from a keypad that does not have a built in reader, you will need to select a reader from the list before proceeding. Swipe the Token at the selected reader.

```
Token belongs to Ur2
Debbie Smith
```

```
Press OK or MENU
```

- 3) To exit, press [OK] or [MENU].

Access > Token >

Edit Token

**I-M** MENU 1-2-3

This menu allows the installer or master user to view or change the token ID for any user.

- 1) Press [MENU] + [1] + [2] + [3] and use the up and down arrows to highlight the user in the list, then press [OK].

```
Ur1 John Smith
Ur2 Debbie Smith
Ur3 User 3 Name
Press ▲▼ OK or MENU
```

- 2) The keypad will display the current token ID of the user selected.

```
Edit Token Ur1
0000000000
Press 0-9 OK to SAVE
```

- 3) Press [OK] to save and exit or press [MENU] to exit without saving.

Access > Token >

Delete Token

**I-M** MENU 1-2-1

This menu allows the installer or master user to delete an existing user's token ID.

- 1) Enter [MENU] + [1] + [2] + [1] and use the up and down arrows to highlight the user in the list then press [OK]. The keypad will only display users that have tokens assigned to them.

```
Ur1 John Smith
Ur2 Debbie Smith
Ur3 User 3 Name
Press ▲▼ OK or MENU
```

- 2) Press [OK] to delete the token or press [MENU] to exit without saving.

```
Press OK to Delete Token
For Ur1
John Smith
Press OK or MENU
```

Access > Token >

Token Status

**I-M** MENU 1-2-2

This menu allows the installer or master user to identify which user a token has been assigned to. You will need to have the token in order to do the test. This menu can only be performed at a prox keypad.

- 1) Enter [MENU] + [1] + [2] + [2]. The keypad will prompt you to swipe the token to be checked.

```
Present Token to be
Identified
Press OK or MENU
```

- 2) Present the token to the keypad, you will hear a confirmation beep and the display will show the token status.

## RF KEYFOBS

This section outlines how to add and delete RF keyfobs. RF keyfobs provide an alternate method for users to turn the system on and off. Each user can have one RF keyfob assigned.

The RF keyfob must be compatible with the RF Receiver that has been programmed in MENU 3-5-0 — Input Type.

Refer to MENU 6-2-2 — RF Device Options to configure the following preferences for RF keyfobs.

- ❖ Audible RF Keyfob Panic,
- ❖ Report RF Keyfob Panic and
- ❖ RF Keyfob 'Part On' Arming Allowed.

RF keyfobs will follow all user settings.

Access > RF Keyfob >

### Add Keyfob

**I-M** MENU 1-3-0

This menu allows the installer or a master user to assign an RF keyfob to a user. Only users 001 to 128 can have an RF keyfob assigned if required.

- 1) Enter [MENU] + [1] + [3] + [0] and use the up and down arrows to highlight the user in the list then press [OK]. The keypad will only list users that don't already have an RF Keyfob assigned.

```
Ur1 John Smith
Ur2 Debbie Smith
Ur3 User 3 Name
Press ▲▼ OK or MENU
```

- 2) Enter the RF Keyfob ID number, or transmit the keyfob ID by pressing a button on the keyfob.

```
Enter Keyfob ID Ur2
Debbie Smith
000000000
Press OK or MENU
```

- 3) Press [OK] to save and exit or press [MENU] to exit without saving.

Access > RF Keyfob >

### Delete Keyfob

**I-M** MENU 1-3-1

This menu allows the installer or a master user to delete an RF Keyfob ID that has been assigned to a user.

- 1) Enter [MENU] + [1] + [3] + [1] and use the up and down arrows to highlight the user in the list then press [OK]. The keypad will only list users that have an RF Keyfob assigned.

```
Ur1 John Smith
Ur2 Debbie Smith
Ur3 Mary Smith
Press ▲▼ OK or MENU
```

- 2) Press [OK] to delete the RF Keyfob ID number and exit or press [MENU] to exit without saving.

```
Press OK To Delete
Keyfob For Ur1
009553507
Press OK or MENU
```

Access > RF Keyfob >

### Test Keyfob

**I** MENU 1-3-2

This menu allows the installer to test the RF keyfob operation. Key the transmitter a number of times and the display will show the number of transmissions received and a signal level of Good, Poor, Relocate or Average.

- 1) Enter [MENU] + [1] + [3] + [2] and use the up and down arrows to highlight the user in the list then press [OK]. The keypad will only list users that have an RF Keyfob assigned.

```
Ur1 John Smith
Ur2 Debbie Smith
Ur3 User 3 Name
Press ▲▼ OK or MENU
```

- 2) Press any key on the transmitter you wish to test.

```
Ur2 Debbie Smith
Waiting for Trigger!
Press OK or MENU
```

If the system receives the signal the following screen will appear.

```
Ur2 Debbie Smith
Transmissions = 001
Signal = Average
Press OK or MENU
```

- 3) Repeat step 2 as required and then press [OK] to exit.



## USER PROPERTIES

This section outlines user properties including User Name, Area Assignment, User Options, TimeZone Access, Door Assignment, and Expire Date.

Access > User Properties >

User Name I-M MENU 1-4-0

U s e r 1 N a m e

This menu allows the installer or a master user to program the user's name (max of 20 characters). This name is used for system greetings, reporting and log entries to identify the user by name.

- 1) Enter [MENU] + [1] + [4] + [0] and use the up and down arrows to highlight the user in the list then press [OK].

```
Ur1 User 1 Name
Ur2 User 2 Name
Ur3 User 3 Name
Press ▲▼ OK or MENU
```

- 2) Use the arrow and number keys to move and change text. When the user name is complete, press [OK]. At any time you can press the [OFF] key to clear the text from the current cursor position to the end of the line.

```
User Name Ur1
User 1 Name
Press ◀▶▲▼ OK to SAVE
```



See Alpha Text Programming in Section 4 — Programming Overview for further detail on entering alpha text.

Access > User Properties >

Area Assignment I-M MENU 1-4-1

1	Security System	Y
2	Area 2 Name	N
3	Area 3 Name	N
4	Area 4 Name	N
5	Area 5 Name	N
6	Area 6 Name	N
7	Area 7 Name	N
8	Area 8 Name	N

This menu allows the installer or master user to program which areas (1 to 8) other users can access. Each user can be assigned to one or multiple areas.

The master user can only assign other users to any one or multiple areas that the master user itself has been assigned to. At factory default, each user is assigned to operate Area 1.

- 1) Enter [MENU] + [1] + [4] + [1] and use the up and down arrows to highlight the user in the list then press [OK].

```
Ur1 John Smith
Ur2 Debbie Smith
Ur3 User 3 Name
Press ▲▼ OK or MENU
```

- 2) Use the up and down arrow keys to highlight the option then press the [ON] key to enable or the [OFF] key to disable.

```
✓ Security System
Area 2 Name
Area 3 Name
Press ▲▼ OK ON OFF MENU
```

- 3) Repeat Step 2 until you have assigned the user to all required areas, then press [OK] to save and exit, or press [MENU] to exit without saving.

Access &gt; User Properties &gt;

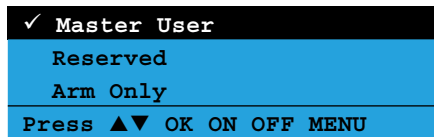
**User Options**

MENU 1-4-2

1	Master User	Y
2	Reserved	N
3	Arm Only	N
4	Can Bypass	Y
5	Auto Bypass Allowed	Y
6	Always Report Op/Cl	Y
7	Reserved	N
8	Reserved	N

The above options can only be programmed by the installer and are programmable per user.

- 1) Enter [MENU] + [1] + [4] + [2] and select the user from the list then press [OK].
- 2) Use the up and down arrow keys to highlight the option then press the [ON] key to enable or the [OFF] key to disable.



- 3) Repeat Step 2 until all options are programmed as required, then press [OK] to save and exit or press [MENU] to exit without saving.

**Master User**

Setting this option assigns the user to a master user. Master users have access to additional menus that ordinary users do not have. See the Menu Reference Table in Section 4 for a list of available Master User commands.

**Arm Only**

Setting this option restricts the user to only turn an area on. The PIN has no access to turn an area off or reset an alarm.

**Can Bypass**

Setting this option allows the user to manually bypass and un-bypass zones.

**Auto Bypass Allowed**

Setting this option allows the user to turn an area on when one or more zones are still faulted or open. Upon arming, the area, the keypad will prompt the user to automatically bypass each faulted zone by pressing the [OK] key.

To prevent users from being able to force arm an area you will need to disable this option.

**Always Report Op/Cl**

Setting this option will cause the system to send opening and closing reports when the user arms and disarms an area.

**UNDERSTANDING TIMEZONES**

Timezones can be used to restrict users from operating doors outside given times.

To do this, you need to create a timezone. Each timezone includes a maximum of 4 different time periods. Each time period can be set to different days of the week (including holidays). Then assign one or more user's to the timezone to specify the access period, day of the week and holidays. This now restricts the user from accessing the system outside the nominated times and days within the timezone.

**User**

Can only belong to 1 timezone.

**TimeZones**

Only one timezone can be linked to each user.

**TimeZone Access Example**

- 1) To set up timezone access, you need to select an unused timezone from 1 to 16, in this example we will assume timezone access number to be 5.
- 2) Select timezone 5 and program the times and days of the week.
- 3) Then under the user timezone access properties, assign all users who you wish to restrict to timezone access 5. Remember that you are only able to assign a user to one timezone.

A master code holder is able to change the timezones so they can change the access times for a given user. If a user tries to operate the system outside their assigned timezone periods, then access will be denied.

Access &gt; User Properties &gt;

**TimeZone Access****I-M MENU 1-4-4**

0 1

00 - Disabled  
 01 - 24 Hour TimeZone      09 - TimeZone 9 Name  
 02 - TimeZone 2 Name      10 - TimeZone 10 Name  
 03 - TimeZone 3 Name      11 - TimeZone 11 Name  
 04 - TimeZone 4 Name      12 - TimeZone 12 Name  
 05 - TimeZone 5 Name      13 - TimeZone 13 Name  
 06 - TimeZone 6 Name      14 - TimeZone 14 Name  
 07 - TimeZone 7 Name      15 - TimeZone 15 Name  
 08 - TimeZone 8 Name      16 - TimeZone 16 Name

This menu is used to assign a user to a timezone. Time zones are used to restrict user access to be within specific times. Each user can only be assigned to one time zone. Setting this option to 1 will give the user 24 hour access to the system.

- 1) Enter [MENU] + [1] + [4] + [4] and select the user from the list and press [OK].

```

TimeZone Access Url
01 - 24 Hour TimeZone
Press ▲▼ 0-9 OK to SAVE
  
```

- 2) Use the arrow and number keys to select the time zone (00 to 16) that you want the user to follow, then press [OK] to save and exit.

Access &gt; User Properties &gt;

**Door Assignment****I-M MENU 1-4-5**

0 0

1	Door 1 Name	N
2	Door 2 Name	N
3	Door 3 Name	N
4	Door 4 Name	N
5	Door 5 Name	N
6	Door 6 Name	N
7	Door 7 Name	N
8	Door 8 Name	N
9	Door 9 Name	N
10	Door 10 Name	N
11	Door 11 Name	N
12	Door 12 Name	N
13	Door 13 Name	N
14	Door 14 Name	N
15	Door 15 Name	N
16	Door 16 Name	N

This menu allows you to assign each user to one or multiple doors. A door assignment is used to allow and/or restrict which users have access to various keypads, readers and outputs.

- 1) Enter [MENU] + [1] + [4] + [5] and select the user from the list then press [OK].

```

Ur1 John Smith
Ur2 Debbie Smith
Ur3 User 3 Name
Press ▲▼ OK or MENU
  
```

- 2) Use the up and down arrow keys to highlight the door assignment, then press the [ON] key to select or the [OFF] key to deselect.

```

Door 1 Name
Door 2 Name
Door 3 Name
Press ▲▼ OK ON OFF MENU
  
```

- 3) Repeat Step 2 until all required door assignments are programmed, then press [OK] to save and exit or press [MENU] to exit without saving.

Access &gt; User Properties &gt;

**User Expire Date****I - M MENU 1-4-6**

By default, the user expire date for each user is set to 1 January 2100 which ensures that each user practically never expires. If a programmed user expire date is reached, all user credentials including PIN, fingerprint, token, RF keyfob etc will be disabled and a log entry made (eg. Ur003 John Smith User Expired).

A master user cannot be expired and the master user is allowed to change another user's expire date. To return the expire date to default, press the [OFF] key to allow the user to operate indefinitely, or press the [ON] key to set the date to the current system date, then make the necessary adjustments to achieve the required expired time.

- 1) Enter [MENU] + [1] + [4] + [6] and select the user from the list then press [OK].

```
Ur1 John Smith
Ur2 Debbie Smith
Ur3 User 3 Name
Press ▲▼ OK or MENU
```

- 2) Use the up and down arrow keys to toggle the day, month and year. Use the left and right keys to move the cursor between the day month and year.

```
User Expire Date Ur1
Expire Date
01 Jan 2100
Press ◀▶▲▼ OK to SAVE
```

- 3) Press [OK] to save and exit or press [MENU] to exit without saving.



Setting the user option 'Master PIN' for a user will override the user expire date.

Access &gt; Global Properties &gt;

**PIN Length****I MENU 1-5-0**

(\*\*\*) System Wide Parameter (\*\*\*)

0 4

00 - Variable	03 - 3 Digits	06 - 6 Digits
01 - 1 Digit	04 - 4 Digits	07 - 7 Digits
02 - 2 Digits	05 - 5 Digits	08 - 8 Digits

At factory default, all user PINs are set to be 4 digits long. This menu allows you to change the length for all PIN codes.

If you select the variable PIN length option, then you are free to create PINs with different lengths. For example User 1 could have a 4 digit PIN number while user 3 can have an 8 digit PIN number.

Variable PIN lengths are useful for increasing security levels. Another use would be to program a single digit PIN to trigger an output. To do this create a user that is not assigned to an area and then map this to the required output.

- 1) Enter [MENU] + [1] + [5] + [0]. The keypad will display the current PIN length.

```
PIN Length
04 - 4 Digit Length
Press ▲▼ 0-9 OK to SAVE
```

- 2) Select the required PIN length using the up and down arrow keys then press [OK] to save and exit or press [MENU] to exit without saving.

Access &gt; Global Properties &gt;

**PIN Retry Count****I MENU 1-5-1**

(\*\*\*) System Wide Parameter (\*\*\*)

0 6

This menu sets how many times an invalid PIN can be entered before the keypad will be quarantined or locked out. See MENU 6-1-8 — Keypad Lockout Time to set the lockout time period.

An access denied report will be sent to the base station when the keypad is quarantined. If keypad lockout is not required set this option to 0.

The PIN retry count is reset every time the corresponding area is turned All On, Part On or Off.

The PIN retry count is not applicable for invalid tokens swiped at proximity readers or fingerprints presented at biometric readers.

- 1) Enter [MENU] + [1] + [5] + [1]. The keypad will display the current PIN retry count.

```
PIN Retry Count
6
Press 0-9 OK to SAVE
```

- 2) Enter the required PIN Retry Count using the up and down arrow keys then press [OK] to save and exit or press [MENU] to exit without saving. Valid entries are 1 - 15 , 0 = Unlimited.

Access > Global Properties >

Installer PIN

**I** MENU 1-5-2

1 2 3 4 A A A A

(\*\*\* System Wide Parameter \*\*\*)

This menu sets the Installer PIN. The installer can access all menu functions and can also disarm one or multiple areas. The installer PIN can be up to 8 digits long.

The factory default Installer PIN is 1234.

- 1) Enter [MENU] + [1] + [5] + [2]. The keypad will display the current Installer PIN.

```

Installer PIN
1234AAAA
Press ◀▶▲▼ OK to SAVE
  
```

- 2) Enter the new installer PIN, then press [OK] to save and exit or press [MENU] to exit without saving.

Access > Reporting >

Access Route

**I** MENU 1-6-0

00 - Log Events Only  
 01 - Dest 1 + Log  
 02 - Dest 2 + Log  
 03 - Dest 1 & 2 + Log  
 04 - Dest 2 If 1 Fails

0 1

This menu programs the destination for access reports. Only one option can be programmed in this menu.

- 1) Enter [MENU] + [1] + [6] + [0] and select the area from the list then press [OK].  
 2) Use the numeric keys 0-9 or the up and down arrow keys to select the desired option.

```

Access Route
00 - Log Events Only
Press ▲▼ 0-9 OK to SAVE
  
```

- 3) Press [OK] to save and exit or press [MENU] to exit without saving.

Access > Reporting >

Access Options

**I** MENU 1-6-1

1	Access Granted	Y
2	Access Denied	Y
3	Egress Granted	Y
4	Egress Denied	Y
5	Reserved	N
6	Reserved	N
7	Reserved	N
8	Reserved	N

The above options are programmable per ???.

- 1) Enter [MENU] + [1] + [6] + [1] and select the area from the list then press [OK].  
 2) Use the up and down arrow keys to highlight the option, then press the [ON] key to enable or the [OFF] key to disable.

```

✓ Access Granted
✓ Access Denied
✓ Egress Granted
Press ▲▼ OK ON OFF MENU
  
```

- 3) Repeat Step 2 until all options are programmed as required, then press [OK] to save and exit or press [MENU] to exit without saving.

#### Access Granted

This option allows the control panel to report 'Access Granted' events using the destination set in MENU 1-6-0.

#### Access Denied

This option allows the control panel to report 'Access Denied' events using the destination set in MENU 1-6-0.

#### Egress Granted

This option allows the control panel to report 'Egress Granted' events using the destination set in MENU 1-6-0.

#### Egress Denied

This option allows the control panel to report 'Egress Denied' events using the destination set in MENU 1-6-0.

Access &gt; Fingerprint &gt;

**Add Fingerprint****I - M** MENU 1-8-0

This menu allows the installer or master user to assign a fingerprint ID to any users. Only one fingerprint can be assigned to each user. To change a fingerprint for an existing user you will need to first delete the old fingerprint before adding the new one.

- 1) Enter [MENU] + [1] + [8] + [0] and use the up and down arrows to highlight the user in the list then press [OK]. The system will only list users that don't already have fingerprint assigned.

```
Ur1 John Smith
Ur2 Debbie Smith
Ur3 User 3 Name
Press ▲▼ OK or MENU
```

- 2) Select which fingerprint reader that you want to use to learn the user's fingerprint.

```
Fp6 Keypad 6 Name
Exit
Press ▲▼ OK or MENU
```

- 3) Present the finger to be fingerprint reader to learn the user's ID. As you learn the fingerprint, the reader will sound a single beep to confirm that the fingerprint has been learnt.

```
Position Finger for Ur1
John Smith at Fp6
Press OK or MENU
```



**Note** When you add a new fingerprint, it will be automatically loaded into all biometric readers. Fingerprint readers are ready only once the blue light is steady.

Access &gt; Fingerprint &gt;

**Delete Fingerprint****I - M** MENU 1-8-1

This menu allows the Installer or master user to delete a user's fingerprint ID.

- 1) Enter [MENU] + [1] + [8] + [1] and use the up and down arrows to highlight the user in the list then press [OK]. The system will only list users that have a fingerprint assigned.

```
Ur1 John Smith
Ur2 Debbie Smith
Ur3 User 3 Name
Press ▲▼ OK or MENU
```

- 2) Present the finger to be fingerprint reader to learn the user's ID. As you learn the fingerprint, the reader will sound a single beep to confirm that the fingerprint has been learnt.

```
Press OK to delete
Fingerprint for Ur1
User 1 Name
Press OK or MENU
```

Access &gt; Fingerprint &gt;

**Fingerprint Status****I - M** MENU 1-8-2

This menu allows the Installer to identify the user ID of the fingerprint.

- 1) Enter [MENU] + [1] + [8] + [1] and use the up and down arrows to highlight the reader in the list then press [OK]. The system will only list readers that have been configured.

```
Fp6 Keypad 6 Name
Exit
Press ▲▼ OK or MENU
```

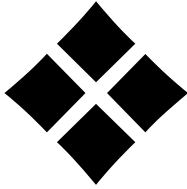
- 2) Present the finger to be fingerprint reader to read the user's fingerprint until a single beep has been heard.

```
Position Finger at
Fp6
Press OK or MENU
```

- 3) The keypad will display the user ID that the fingerprint has been assigned to.

```
Finger belongs to Ur1
John Smith
Press OK or MENU
```

» » END OF SECTION « «



# Area Programming

The control panel has 8 different areas each with its own specific programmable options.

Under the commands menu you can interrogate the status of an area, turn chime mode on/off, move to an area or arm and disarm a specific area.

The customer account number is programmable for each individual area as well as input, output and general options. Each time you are presented with an option that is area specific, the menu will prompt you to specify the area first.

## Partitioning

The control system can be partitioned into 8 individual areas. Each area has its own individual properties which determine how the area operates. The default name for Area 1 is "Security System" and it can be changed to any other name using the area properties menu. All zones and users are assigned to Area 1 so no assigning of users or zones is required for non partitioned systems by default.

To create an area, assign one or more zones to the area of your choice. A zone can only belong to one area and any number of zones can belong to a single area. Each area operates independently from other areas as if it were another security panel and there are numerous options available to tailor just how the entire system should operate. If you require a common area that automatically arms when all other areas are armed, and disarms as soon as any other area is disarmed, then Area 1 can be set as a common area. To make area 1 a common area, set the option under MENU 7-7-1 — Area Options.

All keypads connected to the system have the ability to display the arm/disarm condition of every area at the same time using the area icons on the display. This is selectable per keypad under MENU 6-1-5 — Indicator Options.

Once you log onto a keypad using your [PIN] + [OK] the system knows who you are and will allow you to use the left arrow key to move from the current area to the next area that your assigned to. To move areas without having to enter your PIN select the option under MENU 6-1-2 — Area Options and then simply step through all the available areas using the arrow keys. Each keypad is assigned a home area and will automatically revert back to this area after 60 seconds.

The system outputs must be configured to operate for their corresponding areas. The external siren, internal siren and strobe outputs are defaulted to output index 0 and will operate for any area.

## Example: Simple Two Area System

- 1) Assign zones to area 1 and area 2
- 2) Assign the home areas for the keypads.
- 3) Assign users to areas.
- 4) Set outputs to operate individually or common for all areas.
- 5) Set account number for each area.
- 6) Set options,
  - PIN to change areas or just arrow keys.
  - Which keypads to display area icons.
  - Reset sirens by any user on any area.

## AREA COMMANDS

Areas > Commands >

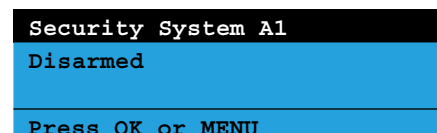
Area Status



MENU 2-0-0

This command allows you to view the condition of any area in the system. In the following example, Area 1 has the name "Security System" and it is currently in the disarmed state.

- 1) Enter [MENU] + [2] + [0] + [0] and select the area to view and press [OK].



The keypad will display the following states:

Disarmed - when the area is turned off.

Armed All On - when the area has been turned All On.

Armed Partial - when the area has been turned Part On.

Armed Part 2 - when the area has been turned Part 2 On.

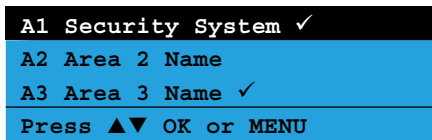
## Areas &gt; Commands &gt;

## Turn Area On/Off

I - M - U MENU 2-0-1

This command allows you to turn on or off areas. If an area has already been turned All On or Part On, a 'tick' (✓) will be displayed on the right side of the area name.

- 1) Enter [MENU] + [2] + [0] + [1] and select the area and press [OK] to change the current state.



## Areas &gt; Commands &gt;

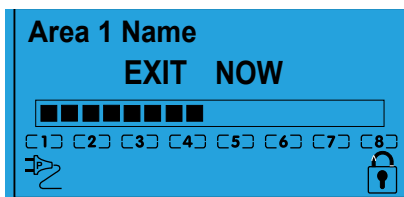
## Turn All Areas On

I - M - U MENU 2-0-2

This command allows you to turn on all areas that your PIN has been assigned to at the same time. An alternative method for arming all areas is to enter your PIN then press and hold the [ON] key for 2 seconds.

- 1) Enter [MENU] + [2] + [0] + [2]. The keypad will display the exit time bar to prompt you to exit all areas. You should leave all areas now.

When exit time has expired, the keypad will display that all areas are turned All On (armed).



**Note** The display area icons option is programmable per keypad. If this option has not been selected then area icons 1 to 8 will not be displayed. See Menu 6-1-5 — Indicator Options.

## Areas &gt; Commands &gt;

## Turn All Areas Off

I - M - U MENU 2-0-3

This command allows you to turn off all areas that your PIN has been assigned to at the same time. This command cannot be accessed from a keypad that is in the armed state. An alternative method for disarming all areas is to enter your PIN, then press and hold the [OFF] key for 2 seconds.

- 1) Enter [MENU] + [2] + [0] + [3] to disarm all areas.

## Areas &gt; Commands &gt;

## Move To Area

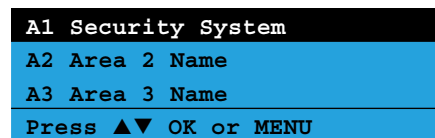
I - M - U MENU 2-0-4

Each keypad on the system can operate any area, however you can only operate the area which is currently being displayed. This menu allows you to change the current keypad view from one area to display another area.

An alternative method for changing the current area being displayed is to enter your PIN and then press the left or right arrow keys. Keep pressing the arrow key until the desired area is displayed. Only areas which have been assigned to the PIN will be available for view.

If you move to another area, the keypad will automatically revert back to its assigned home area after 2 minutes. See MENU 6-1-3 - Home Area.

- 1) Enter [MENU] + [2] + [0] + [4] and select the area from the list and press [OK] to move to the selected area.



*Turn off option - see MENU 6-1-2, PIN To Change Area and just use the [←] and [→] keys to move through all areas on the system without the need to enter your PIN.*

## Areas &gt; Commands &gt;

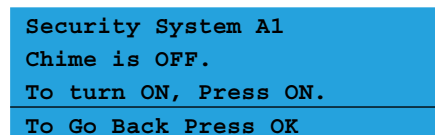
## Chime On/Off

A - I - M - U MENU 2-0-5

Chime mode allows you to monitor a zone (or group of zones) by sounding the keypad buzzer or activating a programmable output. This can be useful when you need to monitor the front or back entrance to a premises while in the disarmed state.

To select which zones will be monitored for chime, see MENU 3-0-3 — Set Chime Zones.

- 1) To turn chime mode on or off, enter [MENU] + [2] + [0] + [5] and select the area from the list then press [OK].



*The chime tone will only be heard on keypads programmed to sound the chime tone. See MENU 6-1-5 — Chime Tone*



Areas &gt; Commands &gt;

**Chime Mode****MENU 2-0-6**

The chime mode option allows you to program how chime zones will operate on an area by area basis. In latching mode a valid PIN will need to be entered to reset the chime alarm.

It is possible to stop the chime alarm if the door is left open for a long period of time or to only trigger the chime alarm if the door is left open for a period of time.

Available options include;

Chime Always  
Chime For 000 Seconds  
Chime After 000 Seconds  
Chime Latching

- 1) To set the required chime mode, enter [MENU] + [2] + [0] + [6] and select the area from the list then press [OK].

```
A1 Security System
A2 Area 2 Name
A3 Area 3 Name
Press ▲▼ OK or MENU
```

- 2) Use the up and down arrow keys to select the required chime mode. If the chosen type requires a time parameter use the right arrow to move to the time field and then use the up and down arrow key to select the appropriate time. When finished press [OK].

```
Chime Mode A1
Chime For 000 Seconds
Press ◀▶▲▼ OK to SAVE
```

**AREA PROPERTIES**

Areas &gt; Area Properties &gt;

**Area Name****MENU 2-1-0**

```
S e c u r i t y   S y s t e m
```

This menu allows you to program the name for each area. Each area name can be programmed with up to 20 characters. At factory default, only Area 1 is used. The control panel can have a maximum of 8 independent areas programmed.

- 1) Enter [MENU] + [2] + [1] + [0] and select the area from the list and press [OK].

```
Area Name A1
Security System
Press ◀▶▲▼ OK to SAVE
```

- 2) Use the arrow and number keys to move and change text. When the area name is complete, press [OK]. At any time you can press the [OFF] key to clear the text from the current cursor position to the end of the line.



See Alpha Text section in Section 4 - Programming Overview for further detail on entering alpha text.

Areas &gt; Area Properties &gt;

**General Options****MENU 2-1-1**

1	Exit Time Restart	N
2	Reset Alarm Memory	N
3	Duress Allowed	Y
4	Fault ACK Required	N
5	One Key Arming	Y
6	One Key Part On	Y
7	Link To Common Area	Y
8	One Key Part Off	N

The above options are programmable per area.

- 1) Enter [MENU] + [2] + [1] + [1] and select the area from the list then press [OK].
- 2) Use the up and down arrow keys to highlight the option, then press the [ON] key to enable or the [OFF] key to disable.

```
Exit Time Restart
Reset Alarm Memory
✓ Duress Allowed
Press ▲▼ OK ON OFF MENU
```

- 3) Repeat Step 2 until all options are programmed as required, then press [OK] to save and exit or press [MENU] to exit without saving.

### Exit Time Restart

The exit delay timer will restart (once per arming cycle) when the same entry/exit delay zone is faulted a second time during exit delay (eg. If an entry/exit delay zone is unsealed, restored and unsealed a second time during exit delay = exit time restart).

### Reset Alarm Memory

Clears all alarm memories displayed on the keypad when a user has turned the corresponding area off. If this option is not set, alarm memory will continue to display until the user has turned the corresponding area on again.

### Duress Allowed

If a user is being forced to turn off the security system under duress, they can disarm the system and initiate a silent duress alarm.

To trigger the duress alarm enter your PIN then repeat the last two digits of your PIN before pressing [ON], [OFF], or [OK] key.

#### **Example:**

If your PIN is 2580, to send a duress report when the area is off,  
Enter, [2] [5] [8] [0] + [8] [0] + [OK] or [ON].

If your PIN is 2580, to send a duress report when the area is on,  
Enter, [2] [5] [8] [0] + [8] [0] + [OFF].

### Fault ACK Required

If this option has been programmed, the control panel will force a user to acknowledge each trouble condition even though the trouble condition has already cleared.

If this option is not programmed, any trouble condition that occurs will not have to be acknowledged if it has already been rectified or cleared.

### One Key Arming

This option allows users to simply press the [ON] key to turn the area All On. All zones being armed must be sealed. If open and close reports are programmed, the user ID number will report as 000.

### One Key Part On

This option allows users to simply press the [Part On] key to turn the area Part On. All zones being armed must be sealed. If open and close reports for Part On is programmed, the user ID number will report as 000.

### Link To Common Area

This option causes the selected area or areas to control the common area. If this option is not selected for an area then it will be able to operate independent of the common area. See MENU 7-7-1 — Area Options to enable the common area.

### One Key Part Off

This option allows users to disarm from Part On or Part 2 On, simply by pressing the [OFF] key. This function will only work if there are no alarms in effect, and the entry timer is not running.

Areas > Area Properties >

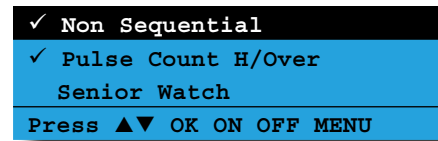
#### **Input Options**

**I** MENU 2-1-2

1	Non Sequential	Y
2	Pulse Count H/Over	Y
3	Senior Watch	N
4	Reset Smoke On Arming	Y
5	Reserved	N
6	Reserved	N
7	Reserved	N
8	Reserved	N

The above options are programmable per area.

- 1) Enter [MENU] + [2] + [1] + [2] and select the area from the list then press [OK].
- 2) Use the up and down arrow keys to highlight the option then press the [ON] key to enable or the [OFF] key to disable.



- 3) Repeat Step 2 until all options are programmed as required, then press [OK] to save and exit or press [MENU] to exit without saving.

### Non Sequential

With non-sequential entry path, you can trigger handover zones in any order provided that an entry delay zone was triggered first.

If this option is not programmed, handover zones must be triggered in numerical sequence provided that an entry delay zone was triggered first.

If a handover zone is triggered before an entry delay zone is triggered an instant alarm will occur.

### Pulse Count H/Over

This option allows zones from the same area that have both pulse count and pulse count time programmed the ability to hand over pulses to other pulse count zones during their respective pulse count time. Only zones that have an active pulse count time can accept pulse count handover from another zone.

Burglary delay zones can only handover pulses to other burglary delay zones. Burglary instant and/or handover zones can handover pulses to other burglary instant and/or handover zones. 24 hour non-fire zone types can only

handover pulses to other 24 hour non fire zones. A 24-hour fire zone can only handover pulses to another 24-hour fire zone.

### Senior Watch

This option requires at least one burglary zone in the corresponding area to be faulted and restored during the senior watch time. If no burglary zone has register during the senior watch time, the keypad will sound an alarm.

To warn the user that senior watch time is about to expire, the keypad will sound the auto arm pre-alert time (if programmed) prior to sounding the alarm. See MENU 2-8-6 — Senior Watch Time.

This feature is not applicable when the corresponding area is turned All On.

An output (Output Event Type 51) can be programmed to operate as follow senior watch if required.

### Reset Smoke On Arming

This option when set, will trigger any output that is programmed as event type 49 - Smoke Sensor GND to operate on the next arming cycle, therefore resetting the connected smoke sensors each time the area is armed.

If this option is not set then a manual reset will need to be performed via MENU 3-0-5.

Areas > Area Properties >

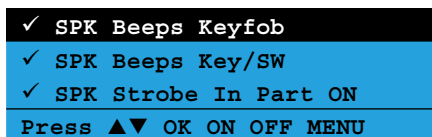
#### Output Options

**I** MENU 2-1-3

1	SPK Beeps Keyfob	Y
2	SPK Beeps Key/Sw	Y
3	SPK Strobe In Part On	Y
4	Alarm On PIN Retry	Y
5	Alarm Exit Error	N
6	Alarm Key/Sw Tamper	Y
7	Reserved	N
8	Reserved	N

The above options are programmable per area.

- 1) Enter [MENU] + [2] + [1] + [3] and select the area from the list then press [OK].
- 2) Use the up and down arrow keys to highlight the option then press the [ON] key to enable or the [OFF] key to disable.



- 3) Repeat Step 2 until all options are programmed as required, then press [OK] to save and exit or press [MENU] to exit without saving.

### SPK Beeps Keyfob

This option allows audible beeps via the speaker output to verify to the user that they have successfully turned the area On or Off using the RF keyfob. The speaker output will sound one beep for Off (disarm), two beeps for All On and three beeps for Part On.

### SPK Beeps Key/Sw

This option allows audible beeps via the speaker output to verify to the user that they have successfully turned the area On or Off using a keyswitch input. The speaker output will sound one beep for Off (disarm), two beeps for All On and three beeps for Part On.

### SPK Strobe In Part On

This option allows the strobe and audible alarms to operate when the area is turned Part On or Part 2 On.

### Alarm On PIN Retry

When the PIN retry count as programmed in MENU 1-5-1 is reached, an audible alarm will occur.

### Alarm Exit Error

This option allows you to sound an alarm when an exit error occurs.

An exit error occurs when an entry/exit delay zone becomes unsealed during the exit delay time and remains unsealed at the end of exit delay time. If this happens, the entry delay will start. If the area is not turned off (disarmed) before the entry delay time expires, an alarm will occur.

### Alarm Key/Sw Tamper

This option allows you to sound an alarm when a tamper condition occurs on a zone programmed as a keyswitch input. Refer to MENU 3-1-1 — Zone Type for information on programming zones to be a keyswitch input.

Areas > Area Properties >

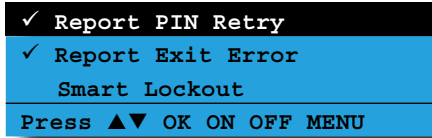
#### Reporting Options

**I** MENU 2-1-4

1	Report PIN Retry	Y
2	Report Exit Error	Y
3	Smart Lockout	N
4	Reserved	N
5	Cancel Report	Y
6	Reserved	N
7	Op/CI In Part On	N
8	Op/CI After Alarm	N

The above options are programmable per area.

- 1) Enter [MENU] + [2] + [1] + [4] and select the area from the list then press [OK].
- 2) Use the up and down arrow keys to highlight the option then press the [ON] key to enable or the [OFF] key to disable.



- 3) Repeat Step 2 until all options are programmed as required, then press [OK] to save and exit or press [MENU] to exit without saving.

### Report PIN Retry

When the PIN retry count as programmed in MENU 1-5-1 is reached, a 'Wrong Code Entry' alarm report will be sent to the control room.

### Report Exit Error

This option allows the system to report an 'Exit Error' alarm report.

An exit error occurs when an entry/exit delay zone becomes unsealed during exit delay time and remains unsealed at the end of exit delay time. If this happens, the entry delay will start. If the area is not turned off (disarmed) before the entry delay time expires an 'Exit Error' alarm report will be sent.

### Smart Lockout

Smart lockout allows a previously locked zone to reactivate during the siren run time when a new alarm event occurs.

### Cancel Report

When set, a 'Cancel' report will be sent if a user disarms the area before the siren timer expires.

### Op/Cl In Part On

When set, the panel will send 'Open' or 'Close' reports when the area has been turned Part On or Part 2 On.

### Op/Cl After Alarm

When set, the panel will only send an 'Open' or 'Close' report after an alarm has occurred. This report will be sent for all users regardless of whether or not they have been programmed to send open/close reports.

Areas > Area Properties >

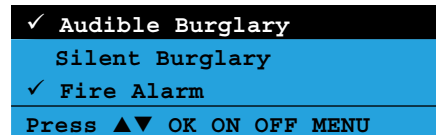
### Strobe Trigger

**I** MENU 2-1-5

1	Audible Burglary	Y
2	Silent Burglary	N
3	Fire Alarm	Y
4	Keyfob On/Off	N
5	Keyswitch On/Off	N
6	Reserved	N
7	24Hr Alarm	Y
8	Reserved	N

Programming any of these options allow the strobe output to operate when the corresponding event occurs. The strobe light must be connected to an output programmed as a event type 48 for it to operate. See Section 8 — Output Programming for more information on output event types.

- 1) Enter [MENU] + [2] + [1] + [5] and select the area from the list then press [OK].
- 2) Use the up and down arrow keys to highlight the option then press the [ON] key to enable or the [OFF] key to disable.



- 3) Repeat Step 2 until all options are programmed as required, then press [OK] to save and exit or press [MENU] to exit without saving.

### Audible Burglary

When selected, the panel will activate the strobe output when an audible burglary zone has triggered an alarm.

### Silent Burglary

When selected, the panel will activate the strobe output when a silent burglary zone has triggered an alarm.

### Fire Alarm

When selected, the panel will activate the strobe output when a zone programmed as fire (audible or silent) has triggered an alarm.

### Keyfob On/Off

When selected, the panel will activate the strobe output for six seconds when a user turns the area on via an RF keyfob. This provides silent feedback to the user that the signal has been received.

## Keyswitch On/Off

When selected, the panel will activate the strobe output for six seconds when a user turns the area on via a keyswitch zone or the programmable input. This provides silent feedback to the user that the signal has been received when turning the area on or off.

## 24Hr Alarm

When selected, the panel will activate the strobe output when a zone programmed as 24-hour (audible or silent) has registered an alarm. Zones programmed as 24-Hour Hold-Up are not included.

Areas > Area Properties >

Part Mode 1 Name



MENU 2-1-6

P a r t 1 A r e a 1 N a m e

This menu allows you to program the name for each area when turning the area Part On or Part 2 On. Each area name can be programmed with up to 20 characters. At factory default, only Area 1 is used. The control panel can have a maximum of 8 independent areas programmed.

- 1) Enter [MENU] + [2] + [1] + [6] and select the area from the list and press [OK].

Part Mode 1 Name A1  
Part 1 Area 1 Name  
Press ◀▶▲▼ OK to SAVE

- 2) Use the arrow and number keys to move and change text. When the area name is complete, press [OK]. At any time you can press the [OFF] key to clear the text from the current cursor position to the end of the line.



See Alpha Text section in Section 4 - Programming Overview for further detail on entering alpha text.

Areas > Area Properties >

Part Mode 2 Name



MENU 2-1-7

P a r t 2 A r e a 1 N a m e

This menu allows you to program the name for each area when turning the area Part On or Part 2 On. Each area name can be programmed with up to 20 characters. At factory default, only Area 1 is used. The control panel can have a maximum of 8 independent areas programmed.

- 1) Enter [MENU] + [2] + [1] + [6] and select the area from the list and press [OK].

Part Mode 2 Name A1  
Part 2 Area 1 Name  
Press ◀▶▲▼ OK to SAVE

- 2) Use the arrow and number keys to move and change text. When the area name is complete, press [OK]. At any time you can press the [OFF] key to clear the text from the current cursor position to the end of the line.



See Alpha Text section in Section 4 - Programming Overview for further detail on entering alpha text.

Areas > Area Properties >

Auto Arming



MENU 2-1-8

0 0

00 - Disabled	09 - TimeZone 9 Name
01 - 24 Hour TimeZone	10 - TimeZone 10 Name
02 - TimeZone 2 Name	11 - TimeZone 11 Name
03 - TimeZone 3 Name	12 - TimeZone 12 Name
04 - TimeZone 4 Name	13 - TimeZone 13 Name
05 - TimeZone 5 Name	14 - TimeZone 14 Name
06 - TimeZone 6 Name	15 - TimeZone 15 Name
07 - TimeZone 7 Name	16 - TimeZone 16 Name
08 - TimeZone 8 Name	

This menu allows you to assign which time zone the area will follow to automatically turn the area All On and/or off (disarm). Only one time zone can be assigned to each area.

- 1) Enter [MENU] + [2] + [1] + [8] and select the area from the list and press [OK].

Auto Arming A1  
00 - Disabled  
Press ▲▼ 0-9 OK to SAVE

- 2) Use the arrow and number keys to select the time zone that you want the area to follow, then press [OK] to save and exit.

## AREA REPORTING

Areas > Reporting >

Account Dest 1

**I** MENU 2-2-0

0 0 0 0 0 0 0 0 0 0 0

The area account number identifies which control panel is reporting to the security company's base station receiver. Each destination can have a different account number programmed. The number should be entered from left to right with trailing zeros.

- 1) Enter [MENU] + [2] + [2] + [0] and select the area from the list then press [OK].
- 2) Using the numeric keys, enter the new account number. Use the up and down arrows to select special characters BCDEF.

```
Account Dest 1 A1
0000000000
Press ◀▶▲▼ OK to SAVE
```

- 3) Press [OK] to save and exit or press [MENU] to exit without saving.

Areas > Reporting >

Account Dest 2

**I** MENU 2-2-1

0 0 0 0 0 0 0 0 0 0 0

The area account number identifies which control panel is reporting to the security company's base station receiver. Each destination can have a different account number programmed. The number should be entered from left to right with trailing zeros.

- 1) Enter [MENU] + [2] + [2] + [1] and select the area from the list then press [OK].
- 2) Using the numeric keys, enter the new account number. Use the up and down arrows to select special characters BCDEF.

```
Account Dest 2 A1
0000000000
Press ◀▶▲▼ OK to SAVE
```

- 3) Press [OK] to save and exit or press [MENU] to exit without saving.

Areas > Reporting >

Open Close Route

**I** MENU 2-2-2

- 00 - Log Events Only
- 01 - Dest 1 + Log
- 02 - Dest 2 + Log
- 03 - Dest 1 & 2 + Log
- 04 - Dest 2 If 1 Fails

0 1

This menu programs the destination for open and close reports. Only one option can be programmed in this menu.

- 1) Enter [MENU] + [2] + [2] + [2] and select the area from the list then press [OK].
- 2) Use the numeric keys 0-9 or the up and down arrow keys to select the desired option.

```
Open Close Route A1
01 - Dest 1 + Log
Press ▲▼ 0-9 OK to SAVE
```

- 3) Press [OK] to save and exit or press [MENU] to exit without saving.

## AREAS TIMERS

Areas > Timers >

Exit Time

**I-M** MENU 2-8-0

0 6 0

Seconds

This menu allows the installer to set the exit time for each area. Exit delay time can be programmed between 0 and 255 seconds. The exit time starts when an area is turned All On or Part On/Part 2 On (armed).

At factory default, when turning an area All On, the keypad will sound the exit warning tone. When turning an area Part On or Part 2 On, only a single beep at the end of exit time will be heard. See MENU 6-1-5 to allow the exit warning tone to be heard when turning an area Part On or Part 2 On.

- 1) Press [MENU] + [2] + [8] + [0]. The keypad will display a list of areas.

```
A1 Security System
A2 Area 2 Name
A3 Area 3 Name
Press ▲▼ OK or MENU
```

- 2) Highlight the area required to change, then press [OK] to select. The keypad will display the current exit time set for the area selected.

```
Exit Time A1
060 Seconds
Press 0-9 OK to SAVE
```

- 3) Using the numeric keys, enter the required entry time in seconds. Valid times are 1 - 255 seconds, 0 = No Exit Time.
- 4) Press [OK] to save and exit or press [MENU] to exit without saving.

Areas &gt; Timers &gt;

Entry Time 1

I-M

MENU 2-8-1

0 2 0

Seconds

This menu allows the installer to set the entry delay time for each area. The entry delay time can be programmed between 0 and 255 seconds. This should be set to allow the user enough time to turn the area off (disarm) before an alarm condition occurs (eg. end of entry time = alarm).

The entry delay timer starts as soon as a user faults a zone programmed as burglary delay 1 (eg. opens the front door) after the area has been turned on and the exit delay timer has expired.

- 1) Press [MENU] + [2] + [8] + [1]. The keypad will display a list of areas.

```
A1 Security System
A2 Area 2 Name
A3 Area 3 Name
Press ▲▼ OK or MENU
```

- 2) Highlight the area required to change, then press [OK] to select. The keypad will display the current entry time set for the area selected.

```
Entry Time 1 A1
020 Seconds
Press 0-9 OK to SAVE
```

- 3) Using the numeric keys, enter the required entry time in seconds. Valid times are 1 - 255 seconds, 0 = No exit time.
- 4) Press [OK] to save and exit or press [MENU] to exit without saving.

Areas &gt; Timers &gt;

Entry Time 2

I-M

MENU 2-8-2

0 4 0

Seconds

This menu allows the installer to set the entry delay time for each area. The entry delay time can be programmed between 0 and 255 seconds. This should be set to allow the user enough time to turn the area off (disarm) before an alarm condition occurs (eg. end of entry time = alarm).

The entry delay timer starts as soon as a user faults a zone programmed as burglary delay 2 (eg. opens the back door) after the area has been turned on and the exit delay timer has expired.

- 1) Press [MENU] + [2] + [8] + [2]. The keypad will display a list of areas.

```
A1 Security System
A2 Area 2 Name
A3 Area 3 Name
Press ▲▼ OK or MENU
```

- 2) Highlight the area required to change, then press [OK] to select. The keypad will display the current entry time set for the area selected.

```
Entry Time 2 A1
040 Seconds
Press 0-9 OK to SAVE
```

- 3) Using the numeric keys, enter the required entry time in seconds. Valid times are 1 - 255 seconds, 0 = No entry tTime.
- 4) Press [OK] to save and exit or press [MENU] to exit without saving.

Areas &gt; Timers &gt;

Part Entry Time

I-M

MENU 2-8-3

0 6 0

Seconds

This menu sets the time period which a keypad will sound its warning tone after a zone is triggered in Part On or Part 2 On modes. The user must disarm the area before the Part Entry Time expires, otherwise an alarm condition will be triggered.

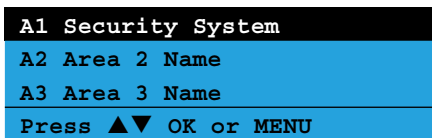
At factory default, when an area has been turned Part On or Part 2 On and exit time has finished, violating a non 24hr burglary zone will start the part entry time. The keypad will sound the hi/lo tone for a period of 60 seconds before the control panel sound an alarm or until the user turns the area off.

The part entry time will start when any of the following zone types area faulted and set to be monitored for Part On or Part 2 On.

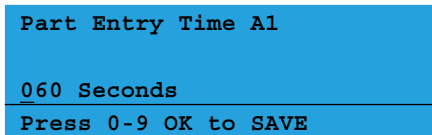
- ❖ Burglary Delay 1
- ❖ Burglary Delay 2
- ❖ Burglary Instant
- ❖ Burglary Inst No Exit
- ❖ Burglary Handover

Only the installer or a master user can set the part entry time for each area (001 to 255 seconds). Programming 001 seconds allows all non 24 hour burglary zones (including delay zones) to act as if they were all instant zones when the area is turned Part On or Part 2 On. Programming 000 seconds allows all non 24 hour burglary zones to operate as they would if the area has been turned All On.

- 1) Press [MENU] + [2] + [8] + [3]. The keypad will display a list of areas.



- 2) Highlight the area required to change, then press [OK] to select. The keypad will display the current part entry time set for the area selected.



- 3) Using the numeric keys, enter the required entry time in seconds. Valid times are 1 - 255 seconds, 0 = No exit time.
- 4) Press [OK] to save and exit or press [MENU] to exit without saving.

Areas > Timers >

#### Auto Arm Pre-Alert

**I** MENU 2-8-4

(\*\*\* System Wide Parameter \*\*\*)

0 0 0

Minutes

This menu allows the installer to program the auto arm pre-alert timer that is global for all areas. The auto arm pre-alert timer can be programmed between 1 and 255 seconds / 0 = disabled.

For the auto arm pre-alert timer to operate, it requires at least one area to follow a timezone. When the stop time and day of the week programmed within a period of the timezone has been met, the control panel will commence the auto arm pre-alert time. When the auto arm pre-alert time has expired, the area will automatically turn All On.

During the auto arm pre-alert time, the keypads assigned

within the same area will sound a warning tone to alert users that the area will soon automatically turn All On.

The auto arm pre-alert timer allows users the opportunity to abort automatic arming for that set arming period, or alternatively delay the area automatically turning All On by 1 hour, by entering their PIN + [OFF] and then selecting the option they require. If the user selects the option to delay the auto arm, this sequence will repeat again 1 hour later until the area is turned All On manually or automatically.

To set up a timezone - see TimeZones.

- 1) Press [MENU] + [2] + [8] + [4]. The keypad will display the current Pre-Alert Time.

Auto Arm Pre Alert

000 Minutes

Press 0-9 OK to SAVE

- 2) Using the numeric keys, enter the pre-alert time. Valid times are 0 to 255 minutes. 0 = No Auto Arm Pre Alert.
- 3) Press [OK] to save and exit or press [MENU] to exit without saving.

Areas > Timers >

#### Senior Watch Time

**I** MENU 2-8-6

(\*\*\* System Wide Parameter \*\*\*)

0 0 0

Hours

This feature can be used to verify that an elderly person is OK or as a dead man timer for an onsite patrolman or security officer.

This menu allows you to program the Senior Watch Time period. The panel must register at least one burglary zone in the programmed area to unseal and reseal during this time period or the panel will report a Senior Watch alarm to the base station.

A Senior Watch Restore will be sent when, at least one zone is unsealed and resealed. Senior Watch monitoring is only active when the corresponding area is in the disarmed state.

- 1) Press [MENU] + [7] + [8] + [6]. The keypad will display the current senior watch time. (default = 0 hours).

Senior Watch Time

000 Hours

Press 0-9 OK to SAVE

- 2) Using the numeric keys, enter the new senior watch time. Valid times are 001 to 255 hours. 000 = No Senior Watch Time.



- 3) Press [OK] to save and exit or press [MENU] to exit without saving.

## AREA TESTING

Areas > Area Testing >

### Area Watch

**I** MENU 2-9-0

(\*\*\* System Wide Parameter \*\*\*)

0 1 2

Weeks

This menu programs the number of weeks (001 – 255 weeks / 000 = disabled) an area can remain disarmed before registering an 'Inactivity Interval' report. A restore signal will be sent when the area is next armed and the exit time expires.

- 1) Enter [MENU] + [2] + [9] + [0]. The keypad will display the current number of weeks programmed for area watch.

```
Area Watch
-----
012 Weeks
Press 0-9 OK to SAVE
```

- 2) Using the numeric keys, enter the number of weeks that an area can remain turned off before a trouble condition will occur. Valid entries are 1 – 255 weeks or 000 to disable.
- 3) Press [OK] to save and exit or press [MENU] to exit without saving.

Areas > Area Testing >

### User Test Interval

**I** MENU 2-9-1

(\*\*\* System Wide Parameter \*\*\*)

0 0 0

Days

This menu sets the number of days before it will prompt the user to walk test the system. To clear the trouble condition, you will need to perform the 'Walk Test' function.

- 1) Enter [MENU] + [2] + [9] + [1]. The keypad will display the current number of weeks between user test intervals.

```
User Test Interval
-----
000 Days
Press 0-9 OK to SAVE
```

- 2) Using the numeric keys, enter the number of days between each user test interval. Valid entries are 1 – 255 days or 000 to disable.
- 3) Press [OK] to save and exit or press [MENU] to exit without saving.

Areas > Area Testing >

### Service Interval

**I** MENU 2-9-2

(\*\*\* System Wide Parameter \*\*\*)

0 0 0

Weeks

This menu sets the number of weeks between service intervals. When a service interval is due, a trouble condition will display on the keypad to remind the customer that a system check is required by the security company. When viewing the trouble condition, the keypad will display 'Call For Service'. To clear the trouble condition, the installer must enter and exit installer's programming mode.

- 1) Enter [MENU] + [2] + [9] + [2]. The keypad will display the current number of weeks between installer service intervals.

```
Service Interval
-----
000 Weeks
Press 0-9 OK to SAVE
```

- 2) Using the numeric keys, enter the number of weeks between each service interval. Valid entries are 1 – 255 weeks or 000 to disable.
- 3) Press [OK] to save and exit or press [MENU] to exit without saving.

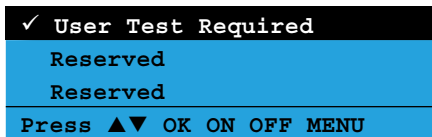
Areas &gt; Area Testing &gt;

**Test Options****MENU 2-9-3**

<b>1</b>	User Test Required	<b>Y</b>
<b>2</b>	Reserved	<b>N</b>
<b>3</b>	Reserved	<b>N</b>
<b>4</b>	Reserved	<b>N</b>
<b>5</b>	Reserved	<b>N</b>
<b>6</b>	Walk Test Report	<b>Y</b>
<b>7</b>	Walk Test 24Hr	<b>N</b>
<b>8</b>	Walk Test Fire	<b>N</b>

The above options are programmable per area.

- 1) Enter [MENU] + [2] + [9] + [3] and select the area from the list then press [OK].
- 2) Use the up and down arrow keys to highlight the option then press the [ON] key to enable or the [OFF] key to disable.



- 3) Repeat Step 2 until all options are programmed as required, then press [OK] to save and exit or press [MENU] to exit without saving.

**User Test Required**

This option allows the keypad assigned to the corresponding area to display a trouble condition when a user test is due. The trouble condition can be cleared by performing a walk test.

**Walk Test Report**

This option allows the corresponding area to send 'Walk Test' reports when a user enters/exits walk test mode and test zones.

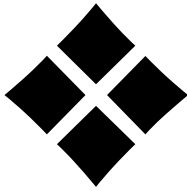
**Walk Test 24Hr**

This option allows any 24-hour (non-fire) zone assigned to the corresponding area to be tested during walk test.

**Walk Test Fire**

This option allows 24-hour fire zone assigned to the corresponding area to be tested during walk test.

» » END OF SECTION « «



# Input Programming

The control panel is capable of controlling up to 144 inputs in either hardwire and/or wireless configuration. Each input can have its own unique name up to 20 characters to identify it on the system for display and reporting purposes.

Under the commands menu you are able to view the status of any input, bypass a zone, define which zones will operate in chime mode, define which zones operate in part 2 mode and reset smoke detectors.

There is a command called 'Zone Array' that allows the installer to view the condition of inputs in banks of 16. This is extremely helpful when commissioning a system or fault finding.

There are numerous configurations for each hardwire input. The end of line resistor can be configured to eliminate the need to change the end of line resistors on a

job when doing a change over. Input zones can be setup as alarm only, alarm + tamper or even split end of line.

For normally open contacts the system is wired exactly the same as for normally closed but there is an option provided that inverts the sealed state of a zone.

When arming the system, all zones will be tested by default and you may wish to turn this option off for certain zones so that you don't continually alert the operator during arming.

The sensor watch feature lets you monitor zones to ensure that they are working and detecting movement within a determined programmable period.

Zones by default can be bypassed and you should disable this option for zones you don't want to be able to bypass, for example 24hr, fire, holdup or panic zone types.

## ZONE ASSIGNMENTS

Zone Assignment Table									
Module Number	Address Setting					Zone Numbers (Single EOL)	Zone Numbers (Alarm+Tamper EOL)	Single or Alarm + Tamper EOL With CM705B + CM707B Module	Zone Numbers (Split EOL)
	SW1	SW2	SW3	SW4	SW5				
Control Panel						1 - 8	1 - 8	N/A	1 - 16
1 =	OFF	OFF	OFF	OFF	OFF	17 to 24	17 to 24	17 to 24 25 to 32	17 to 32
2 =	ON	OFF	OFF	OFF	OFF	33 to 40	33 to 40	33 to 40 41 to 48	33 to 48
3 =	OFF	ON	OFF	OFF	OFF	49 to 56	49 to 56	49 to 56 57 to 64	49 to 64
4 =	ON	ON	OFF	OFF	OFF	65 to 72	65 to 72	65 to 72 73 to 80	65 to 80
5 =	OFF	OFF	ON	OFF	OFF	81 to 88	81 to 88	81 to 88 89 to 96	81 to 96
6 =	ON	OFF	ON	OFF	OFF	97 to 104	97 to 104	97 to 104 105 to 112	97 to 112
7 =	OFF	ON	ON	OFF	OFF	113 to 120	113 to 120	113 to 120 121 to 128	113 to 128
8 =	ON	ON	ON	OFF	OFF	129 to 136	129 to 136	129 to 136 137 to 144	129 to 144

Table 20: Zones Assignments To Modules

The PGM input is a special input that can be configured to accept data from a number of different RF receiver manufacturers or simply be used as an keyswitch input.

The tamper options configure the system behaviour for cabinet tamper alarms and also for the cabinet tamper of the peripheral devices.

**INPUT COMMANDS**

Inputs > Commands >

**Zone Status** A I M U MENU 3-0-0

This menu allows you to view the zone status of each zone (i.e. Normal, Alarm or Tamper etc).

- 1) Enter [MENU] + [3] + [0] + [0] and select the zone you want to view from the list then press [OK]. Alternatively, you can directly enter the zone number to view then press [OK].
- 2) The keypad will display the zone status and EOL resistance value.

```

Zone 1 Name Zn1
EOL=Normal 06523 Ohms
-----
Press OK or MENU
```

- 3) Press the [OK] key to exit.

Inputs > Commands >

**Zone Array** I M U MENU 3-0-1

This menu allows you to view zones in groups of sixteen. The top two rows of the display show the zone number, the third row displays the zone status

**N**= NORMAL  
**S** = SHORTED  
**A**= ALARM  
**T**= TAMPER  
**-** = DISABLED

If a 100 is displayed at the right hand side of the top line, it means that you are displaying zones 97 to 112 or zones 113 to 128 etc. See example.

- 1) Enter [MENU] + [3] + [0] + [1] and use the up and down arrows to select the zone group to view.
- 2) Use the up and down arrows at any time to move to a new group. The keypad will display the following zone array information for zones 1 to 16.

```

0000000001111111
1234567890123456
NSA-ANAT-----
Press ▲▼ OK or MENU
```

In the above example screen,  
**N** = Zone 01 and 06 are Normal (Sealed)

**S** = Zone 02 is Shorted  
**A** = Zone 03,05,07 are in Alarm (Unsealed)  
**T** = Zone 08 is in Tamper Alarm (Unsealed)  
**-** = Zone 04, 09-16 are Disabled (Unused)

- 3) The keypad will display the following zone array information for Zones 97 to 112.

```

9990000000000111 1
7890123456789012 0
----- 0
Press ▲▼ OK or MENU
```

- 4) The keypad will display the following zone array information for Zones 113 to 128.

```

1111111222222222 1
3456789012345678 0
----- 0
Press ▲▼ OK or MENU
```

- 5) When finished press [OK] or [MENU] to exit.

Inputs > Commands >

**Bypass Zones** I M U MENU 3-0-2

This menu allows users with the appropriate access level to manually bypass zones effectively removing them from the area for the current arming cycle. All zone types including 24hour zones can be bypassed. Bypassed zones will be reset when the area is turned off or disarmed.

- 1) Enter [MENU] + [3] + [0] + [2]. A list of zones that can be bypassed will display on the keypad. A tick displayed on the right side of the zone name indicates that the zone is already bypassed.

```

Zn1 Zone 1 Name ✓
Zn2 Zone 2 Name
Zn3 Zone 3 Name
Press ▲▼ OK or MENU
```

- 2) Using the up and down arrow keys highlight the zone that you want to bypass, then press [OK]. Alternatively, you can enter the zone number that you want to bypass, then press [OK]. If the zone is bypassed, the keypad will prompt:

```

Zone 1 Name Zn1 is
bypassed. To un-bypass,
press OFF.
Press OK or MENU
```

- 3) If the zone is not bypassed, the keypad will prompt:

```
Zone 1 Name Zn1 is
un-bypassed. To bypass,
press ON.
Press OK or MENU
```

- 4) Press [ON] or [OFF] to toggle the zone bypass state then press [OK] to save and exit or press [MENU] to exit without saving.
- 5) Repeat steps 1 to 4 to bypass or un-bypass additional zones.

Inputs > Commands >

### Set Chime Zones



MENU 3-0-3

This menu allows you to program zones to be monitored when chime mode is turned on. Chime mode is ideal for monitoring a front door in a shop, a pool gate or other entrance points. To sound the keypad buzzer when a chime zone is opened (faulted). See MENU 6-1-5 — Indicator Options. To turn on chime mode - see MENU 2-0-5 - Chime Mode On/Off.

Chime mode only works when the area is disarmed.

- 1) Enter [MENU] + [3] + [0] + [3] and use the up and down arrow keys to highlight the area from the list then press [OK].
- 2) Use the up and down arrow keys to highlight the zone you want to program, then press [OK]. Alternatively, you can enter the zone number directly then press [OK]. A tick mark displayed on the right side of the zone name indicates that the zone is already set for chime.

```
Zn1 Zone 1 Name ✓
Zn2 Zone 2 Name
Zn3 Zone 3 Name
Press ▲▼ OK or MENU
```

One of the following messages will be displayed depending on the current zone programming.

```
Zone 1 Name Zn1
Zone Chime is OFF,
To turn ON, Press ON.
To Go Back Press OK
```

```
Zone 1 Name Zn1
Zone Chime is ON.
To turn OFF, Press OFF.
To Go Back Press OK
```

- 3) Press [ON] or [OFF] to toggle the zone to be monitored when chime mode is turned on then press [OK] to save and exit or press [MENU] to exit without saving.

Inputs > Commands >

### Set Part 2 Zones



MENU 3-0-4

This menu allows you to program which zones are to be excluded or bypassed when an area has been turned On in Part Mode 2.

- 1) Enter [MENU] + [3] + [0] + [4] and use the up and down arrows to highlight the area from the list then press [OK].
- 2) Use the up and down arrow keys to select the zone(s) that you want to disable in Part 2, then press [OK]. Alternatively, you can enter the zone number directly then press [OK]. Zones marked with a tick are active and will alarm in Part 2 mode.

```
Zn1 Front Door ✓
Zn2 Main Bedroom
Zn3 Lounge Window ✓
Press ▲▼ OK or MENU
```

- 3) One of the following messages will be displayed depending on the current zone programming.
- 4) Press [ON] to arm the zone in Part 2 mode or press [OK] to exit.

```
Main Bedroom Zn2
Is not armed in PART2.
To Enable, Press ON.
To Go Back Press OK
```

- 5) Press [OFF] to disarm the zone in Part 2 mode or press [OK] to exit.

```
Main Bedroom Zn2
Is armed in PART2.
To remove, Press OFF.
To Go Back Press OK
```

Inputs > Commands >

**Smoke Sensor Reset**



**MENU 3-0-5**

This command allows you to reset smoke sensors. When initiated this command will cause any outputs programmed as Event Type 49 — Smoke Sensor GND in the chosen area to turn off for 10 seconds.

- 1) Enter [MENU] + [3] + [0] + [5] and use the up and down arrows to highlight the area that you want to reset the smoke detectors in then press [OK].

Smoke Detector reset in progress. Please wait

- 2) The keypad will automatically return to the menu when all smoke detectors in the area has been reset.



*Smoke detectors must have the negative power terminal connected to an output programmed as Event Type 49 for this command to work.*

**ZONE PROPERTIES**

Inputs > Zone Properties >

**Zone Name**



**MENU 3-1-0**

Z o n e   1   N a m e

This menu allows you to program the name for each zone. Zone names can be up to 20 characters long.

- 1) Enter [MENU] + [3] + [1] + [0] and use the up and down arrows to highlight the Zone in the list then press [OK]. Alternatively, you can enter the zone number directly and press [OK].
- 2) Use the arrow and number keys to move and change text. When the Zone Name is complete, press [OK]. At any time you can press the [OFF] key to clear the text from the current cursor position to the end of the line.

Zone Name Zn1  
Zone 1 Name  
Press ◀▶▲▼ OK to SAVE



*See Alpha Text Programming in Section 4 - Programming Overview for further detail on entering alpha text.*

**ZONE DEFAULT TABLE**

The table below lists the default values for all zone parameters in the control panel. Zones marked as Not Used do not require EOL resistors to be fitted.

Programming	Zone 1	Zone 2	Zone 3	Zone 4	Zones 5 - 16	Zones 17 - 144
Zone Name	Zone 1	Zone 2	Zone 3	Zone 4	Zone 5 to 16	Zone 17 to 144
Zone Type	1 = Delay 1	5 = Handover	5 = Handover	5 = Handover	3 = Instant	0 = Not Used
Area Assignment	1	1	1	1	1	1
Pulse Count	0	0	0	0	0	0
Pulse Count Time	120	120	120	120	120	120
Door Assignment	0	0	0	0	0	0
Report Route	2	2	2	2	2	2
<b>Reporting Options</b>						
Lockout Dialler	Y	Y	Y	Y	Y	Y
Report Alarm	Y	Y	Y	Y	Y	Y
Report Troubles	Y	Y	Y	Y	Y	Y
Report Bypass	Y	Y	Y	Y	Y	Y
Reserved	N	N	N	N	N	N
Reserved	N	N	N	N	N	N
Report Restores	Y	Y	Y	Y	Y	Y
Delay Reporting	N	N	N	N	N	N
<b>Zone Options</b>						
Lockout Siren	Y	Y	Y	Y	Y	Y
Silent Alarm	N	N	N	N	N	N
Inverted Seal	N	N	N	N	N	N
Bypass Allowed	Y	Y	Y	Y	Y	Y
Sensor Watch	N	N	N	N	N	N
Armed In Part On	Y	Y	Y	Y	Y	Y
No EOL Required	N	N	N	N	N	N
Test On Exit	N	Y	Y	Y	Y	Y

*Table 21: Zone Defaults*

Inputs &gt; Zone Properties &gt;

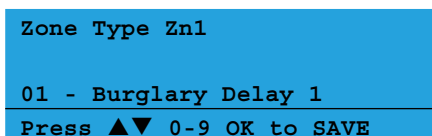
**Zone Type****MENU 3-1-1**

0 1

00 - Not Used	09 - Medical 24Hr
01 - Burglary Delay 1	10 - Panic 24Hr
02 - Burglary Delay 2	11 - Fire 24Hr
03 - Burglary Instant	12 - Not Used
04 - Burg Inst No Exit	13 - Keyswitch Zone
05 - Burg Handover	14 - Display Only
06 - Burglary 24Hr	15 - Non Burglary 24Hr
07 - Tamper 24Hr	
08 - Hold Up 24Hr	

This menu allows you to configure the zone type or behaviour for every zone in the system. Each zone should be assigned to a Zone Type that defines the way in which the panel will respond when an alarm is triggered on that zone. Refer to the table and descriptions below for the available Zone Type selections.

- 1) Press [MENU] + [3] + [1] + [1] and use the up and down arrows to highlight the Zone in the list then press [OK]. Alternatively, you can enter the zone number directly and press [OK].
- 2) Use the up and down arrow keys to select the Zone Type required then Press [OK] to save and exit or press [MENU] to exit without saving.

**00 – Not Used**

Program the zone type as zero if the zone is not being used.

**01 – Burglary Delay 1**

Zones programmed as Delay 1 will cause Entry Timer 1 to start when tripped. The user must disarm the area before entry timer expires or an alarm will occur. Zones set as Burglary Delay 1 are only active when the area is armed. See MENU 7-2-1 — Entry Time 1 to set the required delay time.

**02 – Burglary Delay 2**

Zones programmed as Delay 2 will cause Entry Timer 2 to start when tripped. The user must disarm the area before entry timer expires or an alarm will occur. Zones set as Burglary Delay 2 are only active when the area is armed. See MENU 7-2-2 — Entry Time 2 to set the required delay time.

**03 – Burglary Instant**

Zones programmed as Instant 1 will immediately cause the alarm to trigger when the zone is tripped. ie No Entry Delay. Zones set as Burglary Instant 1 have Exit Delay and are only active when the area is armed. See MENU 7-2-0 — Exit Time

**04 – Burg Inst No Exit**

Zones programmed as Instant 2 will immediately cause the alarm to trigger when the zone is triggered. ie. No Entry Delay. Zones set as Burglary Instant 2 have NO Exit Delay and are only active when the area is armed.

**05 – Burglary Handover**

A Handover zone will provide a delayed alarm only when a delay zone has been tripped first (ie. the entry time is active) otherwise it will trigger an instant alarm.

Zones programmed as Handover can be set to sequential or non-sequential handover. At factory default, handover is set to sequential which means that zone must be triggered in numerical order for the delay to handover. Non Sequential Handover means the zone do not have to be programmed in numerical order. In both cases an entry delay zone must be triggered first for the delay to handover.

See MENU 2-1-2 — Input Options to set Non Sequential Handover.



*The Zone Types listed above will only trigger an alarm if the system or area is in the armed state and the exit time has expired. Zones must be sealed at the end of exit time to trigger alarms.*

**06 – Burglary 24Hr**

Zones programmed as 24-hour burglary will trigger an alarm as soon as the zone becomes faulted regardless of what state the area is in. 24-Hour zones are active 24 hours a day. A 24hr Burglary report will be sent to the central station receiver.

**07 – Tamper 24Hr**

Zones programmed as 24-Hour Tamper will trigger an alarm as soon as the zone becomes faulted regardless of what state the area is in. 24-Hour zones are active 24 hours a day. A 24hr Tamper report will be sent to the central station receiver.

**08 – Hold Up 24Hr**

Zones programmed as 24-Hour Hold Up will trigger a Silent alarm as soon as the zone becomes faulted regardless of what state the area is in. 24-Hour zones are active 24 hours a day. A 24hr Hold Up report will be sent to the central station receiver. No Siren/Strobe or Keypad indication will be given. To view the status of a 24hr hold up zone, refer to MENU 3-0-1.

**09 – Medical 24Hr**

This zone type is used for personal medical emergency alarms. Zones programmed as 24-Medical will trigger an alarm as soon as the zone becomes faulted regardless of what state the area is in. A 24hr Medical report will be sent to the central station receiver.

## 10 – Panic 24Hr

This zone type is used for a general type of emergency including the presence of one or more unwanted persons trying to gain entry to the premises. It will sound an alarm at any time as soon as the zone becomes faulted regardless of what state the area is in. A 24hr Panic report will be sent to the central station receiver.

## 11 – Fire 24Hr

This zone type is used for Fire and Smoke detector alarms. If the EOL configuration is set for a single EOL value, the correct operation for fire zones are SHORT = Alarm / OPEN = Trouble. For this to operate correctly, the option 'Smoke Reset On Arming' needs to be disabled for each area. A 24hr Fire report will be sent to the central station receiver.

If a horn speaker is connected and programmed, a distinct fire sound will be heard to indicate that it is a fire alarm that has registered. The fire sound via the horn speaker is different than the burglary sound.

All fire zones that have registered an alarm will continue to display on all keypads until a fire reset has been performed (see "MENU 3-0-5" on page 146), even if the fire zone input has returned back to normal state. During this time, a user will also be prevented the ability to turn the area on or manually bypass the fire zone(s) until a fire reset has been performed.

## 13 – Keyswitch Zone

A keyswitch zone can be used as an input terminal to turn on and/or off an area. Refer to MENU 3-4-1 — Keyswitch Options to select the various options such as latching or momentary arm and/or disarm etc. When reporting back to base, the keyswitch user number will follow the actual zone number.

## 14 – Display Only

A display zone is not a burglary zone. It can never sound the sirens or trigger the dialler. Its purpose is to only display on the keypad when faulted.

## 15 – Non Burglary 24Hr

This zone type operates as a 24-hour type and is used for non-specific alarms such as water level or temperature sensors.



*The 24 Hour Zone Types listed above are active 24hrs a day. They will trigger an alarm regardless of whether or not the system or area is in the Armed, Part Armed or Disarmed state.*

Inputs > Zone Properties >

### Area Assignment

**I** MENU 3-1-2

0 1

00 - No Area	05 - Area 5 Name
01 - Security System	06 - Area 6 Name
02 - Area 2 Name	07 - Area 7 Name
03 - Area 3 Name	08 - Area 8 Name
04 - Area 4 Name	

This menu programs which area or partition each zone belongs to. The system can be partitioned to a maximum of 8 separate areas. Each zone can only be assigned to a single area. For installations requiring a common access point, it is possible to set Area 1 to be a common area. See MENU 7-7-1 — Area Options

- 1) Press [MENU] + [3] + [1] + [2] and use the up and down arrows to highlight the Zone in the list then press [OK]. Alternatively, you can enter the zone number directly and press [OK].

```

Area Assignment  Zn1
01 - Security System
Press ▲▼ 0-9 OK to SAVE
  
```

- 2) Use the up and down arrows to select the area that you want to assign the zone to.
- 3) Press [OK] to save and exit or press [MENU] to exit without saving.



## Inputs &gt; Zone Properties &gt;

## Pulse Count

 MENU 3-1-3

0	0
---	---

Pulses

00 - No Pulse Count	08 - 8 Inertia Pulses
01 - 1 Pulse	09 - 9 Inertia Pulses
02 - 2 Pulses	10 - 10 Inertia Pulses
03 - 3 Pulses	11 - 11 Inertia Pulses
04 - 4 Pulses	12 - 12 Inertia Pulses
05 - 5 Pulses	13 - Door Open Too Long
06 - 6 Inertia Pulses	14 - PreDelay
07 - 7 Inertia Pulses	15 - Reserved

Options 1 to 5 set the number of trigger pulses a single zone must receive before an alarm will be tripped. The number of pulses must be detected within the Pulse Count Time period for an alarm to occur. See MENU 3-1-4 — Pulse Count Time.

Options 6 to 12 sets the number of trigger pulses a single inertia zone must receive before an alarm will be tripped. The number of pulses must be detected within the Pulse Count Time period for an alarm to occur. See MENU 3-1-4 - Pulse Count Time.

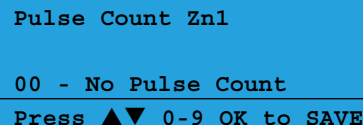
Option 13 - Door Open Too Long is used for door monitoring. In this mode, the zone operates as a normal zone, however, it doubles up as the input sensing point for Door Open Too Long alarms. The pulse count time programmed in MENU 3-1-4 defines the Door Open Too Long time that needs to elapse before the system registers a DOTL alarm.

Option 14 - PreDelay programs how long a zone must be faulted before the zone will register an alarm condition. The pulse count time in MENU 3-1-4 defines how long the zone must stay unsealed before being registered as unsealed. This mode is especially useful when working with refrigeration alarms as you may wish to only trigger an alarm condition if the fridge temperature sensor registers an out of temperature range for a time period before actually triggering the alarm.

A feature called Pulse Count Handover can be enabled allowing pulses registered by one zone to handover to another zone provided they are the same Zone Type (ie. instant zone to instant zone) and in the same Area. See MENU 2-1-2 — Input Options

When pulse count hands over from one zone to another and an alarm is triggered, a cross alarm report will be sent to the central station.

- 1) Press [MENU] + [3] + [1] + [3] and use the up and down arrows to highlight the Zone in the list then press [OK]. Alternatively, you can enter the zone number directly and press [OK]. The keypad will display the current pulse count time for the chosen zone.



```

Pulse Count Znl
00 - No Pulse Count
Press ▲▼ 0-9 OK to SAVE

```

- 2) Using the numeric keys, enter the number of pulses required. Valid entries are 0 – 15 pulses.
- 3) Press [OK] to save and exit or press [MENU] to exit without saving.

## Example of Zone Trigger Delay

## Configure Zone 3 With Delay of 3 Minutes (180 Seconds)

1. Program zone type etc as per normal. Then set Zone pulse count as seconds (Option 13) in MENU 3-1-3.
2. Set the zone 3 delay multiplier in MENU 3-1-4 as 180.

If zone 3 is faulted and remains faulted for 180 seconds, then an alarm event will be triggered. If the zone returns to normal within the 180 second period, then the timer will reset and no alarm will be registered.

Inputs &gt; Zone Properties &gt;

**Pulse Count Time**

MENU 3-1-4

1 2 0

Seconds

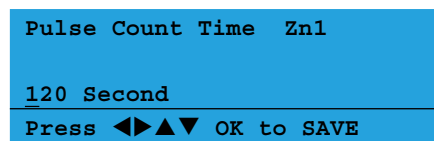
Value	Multiplier
000 - 255	Seconds, Minutes or Hours

Pulse count time operates in accordance with the pulse count option set in MENU 3-1-3. There are four modes of operation that can be set including:

- ◆ Pulse Count
- ◆ Inertia Pulse
- ◆ Door Open Too Long
- ◆ PreDelay

When programming the pulse count time, enter the value between 000 to 255, then set the multiplier in seconds, minutes or hours.

- 1) Press [MENU] + [3] + [1] + [4] and use the up and down arrows to highlight the Zone in the list then press [OK]. Alternatively, you can enter the zone number directly and press [OK]. The keypad will display the current pulse count time.



- 2) Use the [↑] and [↓] keys to set the time required. Valid entries are 0 – 255 seconds.
- 3) Use the [→] key to toggle to cursor and set the multiplier in seconds, minutes or hours using the [↑] and [↓] keys.
- 4) Press [OK] to save and exit or press [MENU] to exit without saving.

**UNDERSTANDING ACCESS GROUPS**

Access Groups are used to link Readers, Users and Outputs together to allow you to operate a door strike when a user token is presented to a given reader. To do this you need to create an access group and assign the user, the reader and the output to the same access group.

**Users**

A user can belong to multiple Access Groups.

**Outputs**

An output can only belong to 1 Access Group.

**Reader**

A reader can belong to only 1 Access Group.

**Access Group**

There are 8 different access groups.

**Door Access Group Example**

- 1) To set up a door access group you need to select an unused Access Group number from 1 to 8, in this example we will assume the Access Group number to be 5.
- 2) Under user properties assign the users who you wish to have access to Access Group 5. Remember that you are able to assign users to more than one Access Group.
- 3) Now select the output that will be used to operate the door strike and assign it to Access Group 5. You also need to set the output type to ACCESS and the polarity to one shot low with a time of how long you would like the strike to operate. Generally a strike would be operated for 5 seconds.
- 4) Assign the Reader under Reader properties to Access Group 5.

When a user who belongs to Access Group 5 presents their token to the reader that is assigned to Access Group 5, the assigned output will operate releasing the door strike.

A reader can belong not only to a Access Group but also to an Area if arming and disarming is required from the reader.

If a user presents their token to an reader that has an area assigned, then the user Access Group and Area Permissions are both checked. If the area is armed and the user belongs to the same area as the Reader and the same Access Group, the system will disarm and allow access.

If the user does not belong to the same area as the reader but the Access Groups match, then door access will only be available to that user if the area is disarmed.

When using the same reader for door access as well as arming, you need to select the badging option MENU 1-6-3 — Reader Options. Badging requires that you present your token 3 times in succession within 5 seconds to arm the system.

Inputs &gt; Zone Properties &gt;

**Door Assignment****I** MENU 3-1-5

0 0

- |                         |                   |
|-------------------------|-------------------|
| 00 - No Door Assignment |                   |
| 01 - Door 1 Name        | 09 - Door 9 Name  |
| 02 - Door 2 Name        | 10 - Door 10 Name |
| 03 - Door 3 Name        | 11 - Door 11 Name |
| 04 - Door 4 Name        | 12 - Door 12 Name |
| 05 - Door 5 Name        | 13 - Door 13 Name |
| 06 - Door 6 Name        | 14 - Door 14 Name |
| 07 - Door 7 Name        | 15 - Door 15 Name |
| 08 - Door 8 Name        | 16 - Door 16 Name |

This menu allows the installer to assign a zone to a single door. There are 16 different doors available.

- 1) Press [MENU] + [3] + [1] + [5] and use the up and down arrows to highlight the Zone in the list then press [OK]. Alternatively, you can enter the zone number directly and press [OK]. The keypad will display the current door assignment.

```
Door Assignment Zn1
00 - No Door Assignment
Press ▲▼ 0-9 OK to SAVE
```

- 2) Use the up and down arrows to select the door that you want to assign the zone to.
- 3) Press [OK] to save and exit or press [MENU] to exit without saving.

Inputs &gt; Zone Properties &gt;

**Report Route****I** MENU 3-1-6

0 1

- |                        |
|------------------------|
| 00 - Log Events Only   |
| 01 - Dest 1 + Log      |
| 02 - Dest 2 + Log      |
| 03 - Dest 1 & 2 + Log  |
| 04 - Dest 2 If 1 Fails |

This menu sets the Zone Report Route or Report Destination for each individual zone in the system. All events such as alarms and troubles for each zone will be reported according to this menu setting. Each zone can only be assigned to one report route from the list above.

- 1) Press [MENU] + [3] + [1] + [6] and use the up and down arrows to highlight the Zone in the list then press [OK]. Alternatively, you can enter the zone number directly and press [OK]. The keypad will display the current Zone Report Route.

```
Report Route Zn1
01 - Dest 1 + Log
Press ▲▼ 0-9 OK to SAVE
```

- 2) Use the up and down arrows to select the Report Route that you want to assign the zone to.
- 3) Press [OK] to save and exit or press [MENU] to exit without saving.



*At factory default all Zones are set to report to Destination 1 and the System Log. See the Zone Default Table for more information on Zone default settings.*

Inputs &gt; Zone Properties &gt;

**Report Options****I** MENU 3-1-7

1	Lockout Dialler	Y
2	Report Alarm	Y
3	Report Troubles	Y
4	Report Bypass	Y
5	Reserved	N
6	Reserved	N
7	Report Restores	Y
8	Delay Reporting	N

The above options are programmable per zone.

- 1) Press [MENU] + [3] + [1] + [7] and use the up and down arrows to highlight the Zone in the list then press [OK]. Alternatively, you can enter the zone number directly and press [OK]. The keypad will display the Report Options for the currently selected zone.
- 2) Use the up and down arrow keys to highlight the option then press the [ON] key to enable or the [OFF] key to disable.

```
✓ Lockout Dialler
✓ Report Alarm
✓ Report Troubles
Press ▲▼ OK ON OFF MENU
```

- 3) Repeat Step 2 until all options are programmed as required, then press [OK] to save and exit or press [MENU] to exit without saving.

**Lockout Dialler**

Setting this option will enable Dialler Lockout functionality for the respective zone(s). All zones in the system can be individually programmed for Dialler Lockout.

When enabled the zone will be allowed to transmit alarm reports each time it is triggered provided that the Swinger Dialler count has not been reached. If the zone is triggered and the Swinger Dialler count has been reached then the zone will become locked out and no further reports will be sent for that zone. Dialler lockout will be reset on the next arming cycle.

See MENU 5-4-5 — Swinger Dialler to set the number of times a zone is allowed to trigger before being locked out.

### Report Alarm

Setting this option will enable the system to Report Alarm events for the respective zone. All zones in the system can be individually programmed to report alarms.

### Report Troubles

Setting this option will enable the system to Report Trouble events for the respective zone. A Trouble report will be sent if the zone is left unsealed at the end of exit time. All zones in the system can be individually programmed to report trouble events.

### Report Bypass

Setting this option will enable the system to Report Zone Bypass events for the respective zone. A Bypass report will be sent at the end of exit time for zones which have been manually bypassed. All zones in the system can be individually programmed to report Zone Bypass events.

### Report Restores

Setting this option allows the system to send Restore reports for zones that have already sent a previous alarm or trouble report on the same arming cycle.

- 1) **Burglary Zone alarms and troubles restore when the zone reseals or the area is disarmed.**
- 2) **24hr Zone alarms and troubles restore when the zone reseals.**
- 3) **Bypassed Zone restore when the area is disarmed.**

### Delay Reporting

Setting this option will cause the system to delay alarm reports for the selected zone. This option can be enabled to allow a user to enter their PIN and disable the report in case they have caused a false alarm. If a PIN is not entered within the delay time, the system will trigger the sirens and send the report as normal.

See MENU 5-4-6 — Burg Report Delay and MENU 5-4-7 — Fire Report Delay to set the delay time.

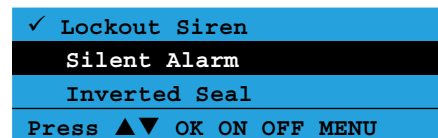
If a PIN code is entered after the delay time has expired, and the sirens are still sounding, the system will send the Alarm report followed by a Cancel report.

Inputs > Zone Properties >

Zone Options		I MENU 3-1-8
1	Lockout Siren	Y
2	Silent Alarm	N
3	Inverted Seal	N
4	Bypass Allowed	Y
5	Sensor Watch	N
6	Armed In Part On	Y
7	No EOL Required	N
8	Test On Exit	Y

The above options are programmable per zone.

- 1) **Press [MENU] + [3] + [1] + [8] and use the up and down arrows to highlight the Zone in the list then press [OK]. Alternatively, you can enter the zone number directly and press [OK]. The keypad will display the Zone Options for the currently selected zone.**
- 2) **Use the up and down arrow keys to highlight the option then press the [ON] key to enable or the [OFF] key to disable.**



- 3) **Repeat Step 2 until all options are programmed as required, then press [OK] to save and exit or press [MENU] to exit without saving.**

### Lockout Siren

Setting this option will enable Siren Lockout functionality for the respective zone(s). All zones in the system can be individually programmed for Siren Lockout.

When enabled the respective zone will be allowed to cause the sirens to sound each time a new alarm is triggered provided that the Swinger Siren count has not been reached. If the zone is triggered and the Swinger Siren count has been reached then the siren will become locked out for that zone and no further siren activations will occur from that zone. Only zones which have been locked out are prevented from triggering the sirens.

Siren lockout will be reset on the next arming cycle. See MENU 7-4-3 — Swinger Siren to set the shutdown count.

### Silent Alarm

Setting this option will set the corresponding zone to become a silent zone. Audible alarm outputs will not sound when a silent zone is triggered.

### Inverted Seal

Setting this option allows a normally-open sensor or device to operate as a normally-closed device by reversing the open/closed state of the zone loop. (eg.

When the zone loop is open, the system will register the zone loop as closed or normal.)

### Bypass Allowed

Setting this option allows users with the appropriate access level to manually bypass this zone effectively removing it from the area for the current arming cycle. All zone types including 24hour zones can be bypassed if this option is selected. Bypassed zones will be reset when the area is turned off or disarmed.

### Sensor Watch

Setting this option causes the system to monitor the zone's activity while the corresponding area is in the disarmed state. If the zone fails to unseal and reseal at least once during the Sensor Watch Time period a system trouble will be displayed on the keypad and a Sensor Watch report for the corresponding zone will be sent to the programmed destination. See MENU 3-9-2 — Sensor Watch to set the time period.



*Sensor Watch monitoring is only active when the area is in the disarmed state. 24 hour zone types cannot be monitored using the Sensor Watch feature.*

### Armed In Part On

Setting this option causes the zone to be active or monitored when the corresponding area is armed Part On.

If this option is not set, the corresponding zone will be inactive when the area is armed Part On allowing users to move freely within this zone and not trigger an alarm.

### No EOL Required

Setting this option allows you to connect a zone loop without the need for an EOL resistor to be fitted as programmed in the global EOL resistor value.

### Test On Exit

Setting this option will cause the system to prompt the user that a zone or zones are not sealed when they attempt to arm the area in which the zone belongs. An error beep will sound and a zone trouble message will display on the keypad advising the user to seal the zone(s) or to bypass them before the area will arm.

If this option is disabled the zone will not be tested during the arming sequence and the system will arm. If the zone(s) are unsealed at the end of exit time a Zone Trouble report will be sent.

## ADDING RF SENSORS

The control panel supports a wide range of 3rd party wireless movement sensors, door contacts and smoke detectors allowing you to choose the most appropriate devices for each installation.

In all cases the RF sensor must be compatible with the RF Receiver that is installed. See MENU 3-5-0 — Input Type.



*Zones configured as RF zone will follow all other zone properties.*

Inputs > RF Zone >

### Add RF Device

**I** MENU 3-3-0

This menu allows you to program an RF device to a zone. Only one RF device can be used for each zone.

- 1) Press [MENU] + [3] + [3] + [0] and use the up and down arrows to highlight the zone you want to program in the list and press [OK]. Alternatively, you can enter the zone number directly and press [OK]. The system will only list zones that don't already have an RF device programmed.

```
Enter Device ID Zn1
Zone 1 Name
000000000
Press OK or MENU
```

- 2) Using the numeric keys, enter the RF device ID number, or trigger the RF device tamper to send the RF device ID.

```
Channel 1
Channel 2
Exit
Press ▲▼ OK or MENU
```

- 3) Use the [↑] and [↓] keys to highlight which channel you want to learn the RF device input (external/internal contact), then press [OK] to select.

Both channel 1 and channel 2 can only be utilised by Bosch 3401E and 3405E sensors, allowing you to utilise both internal and external contacts from the same device on different zones. All other bosch RF sensors can only use channel 1.

- 4) Press [OK] to save and exit or press [MENU] to exit without saving.



*If you require to change a channel, you need to first delete the RF device ID (see MENU 3-3-1) and add the RF device again.*

Inputs &gt; RF Zone &gt;

**Delete RF Device****I** MENU 3-3-1

This menu allows you to delete an RF device .

- 1) Press [MENU] + [3] + [3] + [1] and use the up and down arrows to highlight the zone in the list and press[OK]. The keypad will only list zones that have an ID programmed. If no zones have an ID number programmed, the keypad will display:

```
No Matching List Items
Found!
```

```
Press ▲▼ OK or MENU
```

```
Delete Device ID Zn1
```

```
Zone 1 Name
```

```
007407097
```

```
Press OK or MENU
```

- 2) Press [OK] to DELETE the RF device and exit or press [MENU] to exit without deleting.

Inputs &gt; RF Zone &gt;

**Test RF Device****I** MENU 3-3-2

This menu allows you to test just how good the current position is for an RF device. Enter the command and you will be presented with a list of RF zones in the current area that are available for test. Use the arrow keys to highlight the zone to test and press OK. At any time press menu to exit.

- 1) Press [MENU] + [3] + [3] + [2] and use the up and down arrows to highlight the zone you want to test in the list and press[OK]. Alternatively, you can enter the zone number directly and press [OK]. The system will only list RF zones in the current area.

```
Zn2 Zone 2 Name
W a i t i n g  f o r  T r i g g e r !
```

```
Press OK or MENU
```

- 2) Once a signal is received the following information will be displayed.

```
Zn2 Zone 2 Name
Transmissions = 001
Signal = Good
Press OK or MENU
```

Signal can = Good, Average or Relocate

Every time you send a transmission, the number of transmissions will increment and the average of the signals will be displayed. Be sure to send a few transmissions to establish a more accurate signal measurement.

**GLOBAL INPUT OPTIONS**

Inputs &gt; Global Input Options &gt;

**EOL Value****I** MENU 3-4-0

(\*\*\*) System Wide Parameter (\*\*\*)

0 5

00 - No EOL	08 - 6k8 Ohm
01 - 1k0 Ohm	09 - 8k1 Ohm
02 - 1k5 Ohm	10 - 10k Ohm
03 - 2k2 Ohm	11 - 6K8 Alarm + 2k2 Tamp
04 - 2k7 Ohm	12 - 10k Alarm + 10k Tamp
05 - 3k3 Ohm	13 - 22k Ohm
06 - 4k7 Ohm	14 - 3k3 Alarm + 6k8 Tamp
07 - 5k6 Ohm	15 - Split EOL 3k3 //6k8

This menu programs the End Of Line resistor (EOL) value that is global for all hard-wired zones including zones on the Zone Expander Module. Only one EOL Value can be programmed.

Setting the EOL Value to type 0 to 14 will configure the control panel as 8 hardwired zones. Additional zones via optional zone expander boards will start on zone 9. Setting the EOL as type 15 will configure the control panel as 16 hardware zones with zones 17 upwards via optional zone expander boards.

- 1) Press [MENU] + [3] + [4] + [0]. The keypad will display the current EOL value (Default = 5).

```
EOL Value
```

```
05 - 3k3 Ohm
```

```
Press ▲▼ 0-9 OK to SAVE
```

- 2) Use the up and down arrows to select the EOL Value you want to use then press [OK] to save and exit or press [MENU] to exit without saving.

Inputs &gt; Global Input Options &gt;

**Keyswitch Options****I** MENU 3-4-1

(\*\*\*) System Wide Parameter (\*\*\*)

0 0

00 - Latching All On/Off	05 - Pulse All On/Off
01 - Latching All On	06 - Pulse All On
02 - Latch Part On/Off	07 - Pulse Part On/Off
03 - Latching Part On	08 - Pulse Part On
04 - Latching Off	09 - Pulse Part Off

This menu programs the properties for any zone in the system programmed as a keyswitch zone. Only one option can be selected for the entire system which means that all keyswitches fitted will behave the same way.

The system can send Open and Close reports based on the keyswitch operation with the zone number representing the user number in the report.

- 1) Press [MENU] + [3] + [4] + [1]. The keypad will display the current keyswitch options (Default = 0 Disabled).

```

Keyswitch Options
00 - Latching All On/Off
Press ▲▼ 0-9 OK to SAVE
  
```

- 2) Use the up and down arrows to select the required keyswitch option then press [OK] to save and exit or press [MENU] to exit without saving.

Inputs > Global Input Options >

Input Options		I MENU 3-4-2
1	Tamper On Short	N
2	Reserved	N
3	Response Time 500msec	N
4	Reserved	N
5	Keyswitch Open Close	Y
6	Alarm On Tamper	N
7	Reserved	N
8	Reserved	N

(\*\*\* System Wide Parameter \*\*\*)

This menu programs the various global input options which will effect all zones on the system.

- 1) Press [MENU] + [3] + [4] + [2]. The keypad will display the current input options.

```

Tamper On Short
Reserved
Response Time 500msec
Press ▲▼ OK ON OFF MENU
  
```

- 2) Use the up and down arrow keys to highlight the option then press the [ON] key to enable or the [OFF] key to disable.
- 3) Repeat Step 2 until all options are programmed as required, then press [OK] to save and exit or press [MENU] to exit without saving.

### Tamper On Short

Setting this option will cause any Zone which become shorted to report a tamper alarm condition for the zone.

### Response Time 500msec

Setting this option will increase the response time for all zones to 500ms.

### Keyswitch Open Close

This feature allows you to select whether or not a zone programmed as a Keyswitch Zone, will send opening and closing reports. The default is set to Off.

### Alarm On Tamper

This option allows tamper circuits on RF sensors and hardwire zones to sound an alarm when faulted when their corresponding area is turned off (disarmed).

Inputs > PGM Input >

Input Type I MENU 3-5-0

```

00 - Disabled
01 - Latching On/Off
02 - Pulse On/Off
03 - Simple RF On/Off
04 - Bosch Serial Rcvr
05 - Crow Serial Rcvr (TBA)
  
```

This menu option is used to configure the systems programmable input terminal. Various devices can be connected including keyswitches of radio controlled relays etc. When RF zones are required you need to connect the RF receiver to this input

Connect keyswitch between Input terminal and GND. See Wiring Diagrams in Section 3 for various connection diagrams.

- 1) Press [MENU] + [3] + [5] + [0]. The keypad will display the current input type (Default = 0 Disabled).

```

Input Type
00 - Disabled
Press ▲▼ 0-9 OK to SAVE
  
```

- 2) Use the up and down arrows to select the required Input Device Type then press [OK] to save and exit or press [MENU] to exit without saving.



*The Latching and Momentary On/Off modes are active low, and when triggered, they will automatically force arm the area.*

Inputs &gt; Tamper Inputs &gt;

**Tamper Options****I** MENU 3-6-0

1	Display Panel Tpr	Y
2	Report Panel Tpr	Y
3	Audible Panel Tpr	Y
4	Display Expander Tpr	Y
5	Report Expander Tpr	Y
6	Audible Expander Tpr	Y
7	Reserved	N
8	Reserved	N

This menu programs how the various system tamper inputs behave when faulted. These dedicated tamper inputs are active 24 hours a day when enabled.

- 1) Press [MENU] + [3] + [6] + [0]. The keypad will display the current tamper options.

```

✓ Display Panel Tpr
✓ Report Panel Tpr
✓ Audible Panel Tpr
Press ▲▼ OK ON OFF MENU

```

- 2) Use the up and down arrow keys to highlight the option then press the [ON] key to enable or the [OFF] key to disable.
- 3) Repeat Step 2 until all options are programmed as required, then press [OK] to save and exit or press [MENU] to exit without saving.

**Display Cabinet Tpr**

Setting this option allows the keypad to display a trouble condition when the tamper circuit that monitors the systems cabinet is faulted. The trouble condition will clear when the tamper circuit has restored.

**Report Cabinet Tpr**

Setting this option allows the panel to send a Cabinet Tamper report when the cabinet tamper circuit is faulted. A Cabinet Tamper Restore report will be sent when the tamper circuit has restored.

**Audible Cabinet Tpr**

Setting this option will cause the panel to sound the sirens when the cabinet tamper circuit is faulted.

**Display Expander Tpr**

Setting this option causes the system to display tamper events which have occurred on peripheral modules.

**Report Expander Tpr**

Setting this option enables peripheral tamper reporting.

**Audible Expander Tpr**

Setting this option causes the system to trigger an audible alarm when a peripheral tamper is triggered.

**INPUT TESTING**

Inputs &gt; Input Testing &gt;

**Walk Test All Zones****I-M-U** MENU 3-9-0

This menu allows you to test all zones within an area at the same time. To perform a successful walk test, each zone in the area must be sealed and unsealed. Users must have access to the area they want to test.

Once the mode is activated all zones in the area will be listed one after the other on the keypad display. As each zone is successfully tested it will be removed from the list leaving only those zone still to be tested in the list.

- 1) Press [MENU] + [3] + [9] + [0] and select the area to walk test from the list then press [OK].
- 2) The keypad will begin scrolling all of the zones that are to be tested as per the below display.

```

To test zone Zn1
open then close
Zone 1 Name
Press OK or MENU

```

```

To test zone Zn2
open then close
Zone 2 Name
Press OK or MENU

```

- 3) Open and close each zone in the list. Zones that have been successfully tested are removed from the keypad scroll list. When all zones have been tested, the keypad will display:

```

All zones have been
sucessfully tested
Press OK or MENU

```

- 4) Press [OK] or [MENU] to exit.

Inputs &gt; Input Testing &gt;

**Walk Test A Zone****I-M-U** MENU 3-9-1

This menu allows you to select a single zone to be walk tested. To perform a successful walk test, the selected zone must be sealed and unsealed. Users must have access to the zone they want to test.

- 1) Press [MENU] + [3] + [9] + [1] and use the up and down arrows to highlight the zone you want to walk test in the list and press [OK]. Alternatively, you can enter the zone number directly and press [OK].
- 2) The keypad will display the zone to be tested.



```
To test zone Zn1
open then close
Zone 1 Name
-----
Press OK or MENU
```

- 3) Open and close the zone that needs to be tested. When the test has been completed the keypad will display:

```
Zn1 Zone 1 Name
Test Successful
-----
Press OK or MENU
```

- 4) Press [OK] or [MENU] to exit.

Inputs > Input Testing >

Sensor Watch Time



MENU 3-9-2

(\*\*\* System Wide Parameter \*\*\*)

0 3 0

Days

This menu programs the Sensor Watch Time interval. Zones programmed for Sensor Watch are required to seal and unseal at least once within the Sensor Watch Time period or a trouble message will be displayed on the keypad and a Zone Trouble report sent.

Valid entries are 001 -255 Days and 000 = Sensor Watch Disabled

- 5) Press [MENU] + [3] + [9] + [2]. The keypad will display the current sensor watch time (Default = 30 days).

```
Sensor Watch Time
030 Days
-----
Press 0-9 OK to SAVE
```

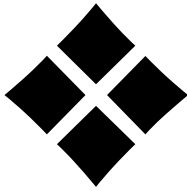
- 2) Using the numeric keys, enter the new Sensor Watch time in days then press [OK] to save and exit or press [MENU] to exit without saving.



*Sensor Watch monitoring is only active when the area is in the disarmed state. 24 hour zone types cannot be monitored using the Sensor Watch feature.*

» » E N D O F S E C T I O N « «





# Output Programming

The Solution 144 is capable of controlling up to 16 outputs. The first 4 outputs are on the main control board and an additional 4 outputs are provided using an output expander module. Each output can have its own unique name up to 16 characters to identify it on the system for display and reporting purposes.

Under the commands menu you are able to view the status of any output and to change its on/off condition. In the case of latching output types, you will be required to reset the output manually using these commands.

Outputs are programmed using an event type. First select the event type that will cause the output to trigger. Then select the polarity of the event, if it is low and goes high or high and goes low. If the event is pulsing or one shot type, the time parameter must also be programmed to define the time of the pulse.

Event Assignment, this is extremely important parameter and has a different meaning depending on the event type selected. For example, event type "24 - Area Part On" the event assignment selects the Area that is armed in part on for the output to trigger. If you set the event assignment to 1, then it will correspond to area 1 and so on, setting it to zero means all areas. See the event type table for more detail on the relationship of event type to event assignment.

Outputs 1 and 2 are special outputs that can be configured as horn speaker polarity types and are monitored to report a device connection trouble. Output 4 is a dry relay contact which has a optional jumper that allows you to switch positive or negative without the need to add additional wiring.

The outputs are all protected and will shut down individually under overload conditions. A report will be generated and a displayed on the keypad to indicate the trouble condition.

## OUTPUT COMMANDS

Outputs > Commands >

**Output Status** A I M U **MENU 4-0-0**

This command allows you to view the current status of any system output.

- 1) Press [MENU] + [4] + [0] + [0] and select the output you want to view from the list then press [OK]. Alternatively, you can directly enter the output number that you want to view then press [OK].

The keypad will display the following when the output is currently in the OFF state and ready to activate.

```
External Siren Op1
Is OFF and Ready
-----
Press OK or MENU
```

The keypad will display the following when the output is currently in the OFF state but the connection is missing.

```
External Siren Op1
Is OFF and Ready
Connection Trouble
-----
Press OK or MENU
```

The keypad will display the following when the output is currently in the ON state and ready.

```
External Siren Op1
Is ON and TIMING
Triggered
-----
Press OK or MENU
```

The keypad will display the following when the output is currently in the ON state but the connection is missing.

```
External Siren Op1
Is ON and TIMING
Connection Trouble
-----
Press OK or MENU
```

- 2) Press [OK] or [MENU] to exit.

Outputs > Commands >

**Turn Output On/Off** I-M-U MENU 4-0-1

This command allows you to manually turn any output ON or OFF. Outputs can be configured to control various functions including outside lighting, pool pumps, watering systems, air conditioners etc.

- 1) Press [MENU] + [4] + [0] + [1] and select the output you want to operate from the list then press [OK]. Alternatively, you can directly enter the output number then press [OK].
- 2) The keypad will display the following when the output is off. To turn the Output On, press [ON]. To override any time parameters that the output has set, press and hold the [ON] key.

```
External Siren Op1
Output is OFF,
To turn ON, Press ON.
To Go Back Press OK
```

- 3) The keypad will display the following when the output is on. To turn the output Off, press [OFF].

```
External Siren Op1
Output is ON,
To turn OFF, Press OFF.
To Go Back Press OK
```

- 4) Press [OK] or [MENU] when finished.

Outputs > Commands >

**Output Array** I-M MENU 4-0-2

This menu allows the master user and installer to view output status in groups of 16. Outputs will continuously be updated during the display so that real time status can be seen. The top two rows of the display show the output number, the third row displays the output status

**N** = NORMAL - Off Condition  
**T** = TRIGGERED - On Condition  
**F** = FAULT - Overload Condition  
**-** = DISABLED

- 1) Enter [MENU] + [4] + [0] + [2] and use the up and down arrows to select the output group to view.
- 2) Use the up and down arrows at any time to move to a new group. The keypad will display the following output array information for outputs 1 to 16.

```
0000000011111111
1234567890123456
NNNNN---TF-----
Press ▲▼ OK or MENU
```

In the above example screen,

**N** = Outputs 01 to 05 are Normal (Off)  
**F** = Output 10 has a Fault (Overload)  
**T** = Output 09 is Triggered (On)  
**-** = Outputs 05 to 08 and Outputs 11 to 16 are Disabled or Not Available

- 3) The keypad will display the following output array information for outputs 17 to 32.

```
1112222222222333
7890123456789012
-----
Press ▲▼ OK or MENU
```

- 4) The keypad will display the following output array information for output 33 to 40.

```
3333333444444444
3456789012345678
-----
Press ▲▼ OK or MENU
```

- 5) When finished press [OK] or [MENU] to exit.

Outputs > Commands >

**Door Status** I-M MENU 4-0-3

This menu allows you to view the status of a selected door.

- 1) Enter [MENU] + [4] + [0] + [3].
- 2) A list of available doors will display on the keypad.

```
Dr1 Front Door
Dr2 Computer Room
Dr3 Warehouse Door
Press ▲▼, OK or MENU
```

- 3) Use the [↑] and [↓] keys to select the door that you want to check the status of, then press [OK] to select. Alternatively, you can enter the door number then press [OK].

The keypad will display the following:

```
Front Door Dr1
Door Locked
Press OK or MENU
```

- 4) The following door states can be displayed in the door status menu.

Door Locked  
 Door Unlocked  
 Door Open By TimeZone  
 Door Manually Open  
 Door Forced Open

## 5) When finished press [OK] or [MENU] to exit.

Outputs &gt; Commands &gt;

## Door Array

I-M MENU 4-0-4

This menu allows the master user and installer to view door status of the doors in groups of 16. Doors will continuously be updated during the display so that real time status can be seen. The top two rows of the display show the door number, the third row displays the door status

**L** = Door Locked

**U** = Door Unlocked

**O** = Override

**-** = Disabled or Not Available

- 1) Enter [MENU] + [4] + [0] + [4] and use the up and down arrows to select the door group to view. The keypad will display the following output array information for outputs 1 to 16.

```
0000000001111111
1234567890123456
LLLLL--UUUUO--
Press ▲▼ OK or MENU
```

In the above example screen,

**L** = Doors 01 to 05 are Locked

**O** = Door 13 has a Override condition

**U** = Doors 09 to 12 area Unlocked

**-** = Doors 06 to 08 and Doors 14 to 16 are Disabled or Not Available

## 2) When finished press [OK] or [MENU] to exit.

Outputs &gt; Commands &gt;

## Door Override

I-M MENU 4-0-5

This menu allows you to manually override a door in the event you wish to place the door in a manually open or closed condition.

The first state is to select the door which you wish to override keeping in mind that you will only be presented with a list of doors that you are authorised to access and secondly, that you are a master code holder.

- 1) Enter [MENU] + [1] + [0] + [1].
- 2) Use the arrow keys to highlight the door you wish to override, then press [OK].

```
Dr1 Door 1 Name
Dr2 Door 2 Name
Dr3 Door 3 Name
Press ▲▼ OK or MENU
```

- 3) Use the [ON] and [OFF] keys to override the door and toggle the door open or close, then press [OK]. To abort press [MENU].

```
Door 1 Name Dr1
Door Override is OFF,
To turn ON, Press ON.
To Go Back, Press OK
```

**OUTPUT PROPERTIES**

Outputs &gt; Properties &gt;

**Output Name** I-M MENU 4-1-0

O	u	t	p	u	t		1		N	a	m	e							
---	---	---	---	---	---	--	---	--	---	---	---	---	--	--	--	--	--	--	--

This menu allows you to program the name for each output. Output names can be up to 16 characters long.

- 1) Press [MENU] + [4] + [1] + [0] and use the up and down arrows to highlight the Output in the list then press [OK]. Alternatively, you can enter the output number directly and press [OK].
- 2) Use the arrow and number keys to move and change text. When the Output Name is complete, press [OK]. At any time you can press the [OFF] key to clear the text from the current cursor position to the end of the line. .

```

Output Name Op1
External Siren
Press ◀▶▲▼ OK to SAVE
  
```



See *Alpha Text Programming in Section 4 — Programming Overview* for further detail on entering alpha text.

Outputs &gt; Properties &gt;

**Event Type** I MENU 4-1-1

0	0	0
---	---	---

This menu allows you to set the output event type. See the Output Event Type Table and Event Type Descriptions in this section for more information on the available options.

- 1) Press [MENU] + [4] + [1] + [1] and use the up and down arrows to highlight the Output in the list then press [OK]. Alternatively, you can directly enter the output number and press [OK].
- 2) Use the up and down arrow keys to select the Event Type required then press [OK] to save and exit or press [MENU] to exit without saving. It is also possible to directly enter the Event Type number then press [OK].

```

Event Type Op1
36 - External Audible
Press ▲▼ 0-9 OK to Save
  
```

**01 - Battery Trouble**

This event type will cause the output to operate when the panel detects a low or missing stand-by battery and will reset once a successful battery test has been performed.

Battery tests are performed automatically every 4 hours

and when the system is armed. A manual test can also be requested at any time while the system is disarmed. See MENU 7-9-1 — Battery Test

**02 – AC Trouble**

This event type will cause the output to operate when the panel detects that the AC mains power has been missing for 1 minute and will reset when the power has been restored for 1 minute.

**03 – Telco Line Fail**

This event type will cause the output to operate when the panel detects that the telco line has been disconnected for 30 seconds and will reset when the line has been restored.

**04 – Comm Fail**

This event type will cause the output to operate if the panel fails to report to destination1 or 2 or both. The panel will try to send the report as many times as set in the call attempt counter before registering a comm fail.

The output will restore as soon as a successful report has been sent to the destination that has previously failed to report. If both Destination 1 and Destination 2 had failed to report then successful report to both destinations will need to be made before the output will reset. See MENU 5-2-0 — Call Attempt Count

**05 – 3rd Dial Attempt**

This event type will cause the output to operate when the panel has made 3 unsuccessful call attempts to the base station. The output will reset when all pending messages have been sent or when the maximum number of call attempts have been made.

**06 – Dest Reporting**

This event type will cause the output to operate when the panel is communicating via Destination 1 or 2 and will reset when the transmission ends.

**07 – Reserved****08 – Dest Kiss Off**

This event type will cause the output to operate when the panel receives an kiss-off acknowledgment from the receiving party while communicating via destination 1 or 2. It is recommended that this output is programmed with a one-shot timer.

**09 – User Keyfob Func 1**

This event type will cause the output to operate when Key X is pressed on the Keyfob. This output type is user specific and requires a 4 button keyfob.

**10 – User Keyfob Func 2**

This event type will cause the output to operate when Key Y is pressed on the Keyfob. This output type is user specific and requires a 4 button keyfob.

**11 – Dialler Disabled**

This event type will cause the output to operate if the panel reporting functions are manually disabled and will reset when reporting is enabled. See MENU 5-2-1 — Dialer Options.

**12 – Output Device Missing**

This event type will cause the output to operate when the panel detects that a horn speaker is missing. The output will reset when the horn speaker is reconnected. Only output 1 and 2 can be programmed as a horn speaker outputs. See MENU 4-1-3 — Output Polarity for information on configuring an output to drive a horn speaker

**13 – Output Trouble**

This event type will cause the output to operate when the panel detects that an output device is missing or in an overload condition. The output will reset when all failed outputs have restored or the overload condition has been removed.

**14 – Panel On Line**

This event type will cause the output to operate when the panel seizes the phone line and will reset when the phone line is released.

**15 – Incoming Call**

This event type will cause the output to operate when the panel detects an incoming call on the phone line and will reset when the ring signal stops.

**16 – System Trouble**

This event type will cause the output to operate when the panel detects a system trouble condition and will reset when the condition is cleared.

**17 – Box Tamper**

This event type will cause the output to operate when the panel detects that the onboard cabinet tamper circuit is open. The output will reset when the tamper circuit is closed. No EOL resistor is required on this input.

**18 – Zone Trouble**

This event type will cause the output to operate when the panel detects that a zone has a trouble condition and will reset when the trouble condition has cleared.

**19 – Zone Mirror**

This event type will cause the output to operate when a specific zone is open or unsealed and will reset when the zone closes. See MENU 4-1-2 — Event Assignment for information on

how to set the zone to mirror.

**20 – Zone Alarm**

This event type will cause the output to operate when a specific zone has triggered an alarm and will reset when the corresponding area is disarmed. For a non 24hour zone to trigger an alarm the area must be armed. See MENU 4-1-2 — Event Assignment for information on how to set the zone to monitor.

**21 – Area Disarmed**

This event type will cause the output to operate as soon as the corresponding area is disarmed and will reset when the area is armed in either the All On or Part On modes.

If the output event assignment for this output is set to zero (all areas), then all areas must be disarmed for the output to operate. The output will reset as soon as any area is armed in either the All On or Part On modes.

**22 – Area Part Or All On**

This event type will cause the output to operate when the selected area is armed in either All On or Part On mode. The output will reset when the area is disarmed.

If the event assignment for this output has been set to zero (all areas) then the output will only operate when all areas have been armed in All On or Part On mode. The output will reset as soon any area is disarmed.

**23 – Area All On**

This event type will cause the output to operate as soon as a specific area is armed All On mode and will reset when the area is disarmed.

If the event assignment for this output has been set to zero (all areas), then the output will only operate when all areas have been armed in the All On mode and will reset as soon as any area is disarmed.

**24 – Area Part On**

This event type will cause the output to operate as soon as a specific area is armed Part On mode and will reset when the area is disarmed.

If the event assignment for this output has been set to zero (all areas), then the output will only operate when all areas have been armed in the Part On mode and will reset as soon as any area is disarmed.

**25 – Area Part 2 On**

This event type will cause the output to operate as soon as a specific area is armed Part 2 On mode and will reset when the area is disarmed.

If the event assignment for this output has been set to zero (all areas), then the output will only operate when all areas have been armed in the Part 2 On mode and will reset as soon as any area is disarmed.

**26 – Entry Timing**

This event type will cause the output to operate while either Entry Timer 1, Entry Timer 2 or the Part Mode Entry Timer is active. The output will reset when the entry timer expires or the corresponding area is disarmed.

**27 – Exit Timing**

This event type will cause the output to operate while Exit Timer is active. The output will reset when the exit timer expires or the corresponding area is disarmed.

**28 – End Of Exit Time**

This event type will cause the output to operate when the Exit Time expires and will reset when the corresponding area is disarmed.

**29 – Chime On**

This event type will cause the output to operate when Chime Mode is activated and will reset when Chime Mode is turned off.

If the event assignment for this output is set to zero (all areas), then the output will operate as soon as Chime Mode is activated in any area and will reset when Chime Mode is turned off in all areas.

**30 – Chime Zone Trigger**

This event type will cause the output to operate when a specific Chime Zone is triggered and reset when the Chime Zone reseals.

If the event assignment for this output is set to zero (all areas), then the output will operate as soon as any chime zone is triggered provided that Chime Mode is on in those areas. The output will reset when all Chime Zones are resealed. For this event type to work Chime Mode must be turned on. See MENU 2-0-5 — Chime On/Off



*It also allows the output to reset when chime mode is turned off by the user even if the chime zone is still faulted. It also allows if one or more chime zones remain faulted after the one shot timer has expired, the output programmed for chime will operate or retrigger if another chime zone becomes faulted.*

**31 – Auto Arm Pre Alert**

This event type will cause the output to operate when the Auto Arm Pre-Alert Timer is active and will reset when the Pre-Alert Timer expires or a valid user code is entered.



*The output will also reset when the auto arm pre-alert time has been delayed by by the user.*

**32 – Ready To Arm All On**

This event type will cause the output to operate when the area is disarmed and all zones in the area are sealed. The output will reset when the area is armed or when a zone becomes unsealed.

If the event assignment for this output is set to zero (all areas), then the output will only operate if all areas are disarmed and all zones are sealed. The output will reset if any area is armed or if any zone becomes unsealed.

**33 – Ready To Part Arm**

This event type will cause the output to operate when the area is disarmed and all zones in the area which are to be monitored in Part On mode are sealed. The output will reset when the area is armed or when a Part On zone becomes unsealed.

If the event assignment for this output is set to zero (all areas), then the output will only operate if all areas are disarmed and all Part On zones are sealed. The output will reset if any area is armed or if any Part On zone becomes unsealed.

**34 – Ready To Part 2 Arm**

This event type will cause the output to operate when the area is disarmed and all zones in the area which are to be monitored in Part 2 On mode are sealed. The output will reset when the area is armed or when a Part 2 On zone becomes unsealed.

If the event assignment for this output is set to zero (all areas), then the output will only operate if all areas are disarmed and all Part 2 On zones are sealed. The output will reset if any area is armed or if any Part 2 On zone becomes unsealed.

**35 – Close Sent OK**

This event type will cause the output to operate when the Closing report has been acknowledged (Kissed-Off) by the control room receiver. The output will reset when the area is disarmed. If the output has been assigned to multiple areas then it will only reset when all areas have been disarmed.

**36 – External Audible**

This event type will cause the output to operate when any audible alarm occurs. The output will reset when the system or area is disarmed.

This event type will also generate speaker beeps when the system or area is armed via a RF Keyfob, the Programmable Input Terminal or Keyswitch zone.

- ❖ 1 beep when the area is disarmed
- ❖ 2 beeps when the area is armed All On
- ❖ 3 beeps when the area is armed Part On



**37 – Internal Audible**

This event type will cause the output to operate when any audible alarm occurs. The output will reset when the system or area is disarmed. No speaker beeps are generated for this event type.

**38 – Any Zone Alarm**

This event type will cause the output to operate when any silent or audible alarm occurs. The output will reset when the system or area is disarmed.

**39 – Fire Alarm**

This event type will cause the output to operate when any audible fire zone or keypad emergency fire alarm occurs. The output will reset when the system or area is disarmed.

**40 – Burglary Alarm**

This event type will cause the output to operate when any audible burglary alarm (including keypad emergency panic, medical and tamper alarm) occurs. The output will reset when the system or area is disarmed.

**41 – Silent Alarm**

This event type will cause the output to operate when any silent alarm occurs (including silent fire and silent keypad emergency alarms). The output will reset when the system or area is disarmed.

**42 – Duress Alarm**

This event type will cause the output to operate when a user initiates a Duress alarm.

**43 – Keypad Medical**

This event type will cause the output to operate when a silent or audible medical alarm has been initiated from the keypad. The output will reset when the system or area is disarmed.

To initiate a medical emergency via the keypad, simultaneously press and hold the [7] and [9] keys for 2 seconds.

**44 – Keypad Fire**

This event type will cause the output to operate when a silent or audible fire alarm has been initiated from the keypad. The output will reset when the system or area is disarmed.

To initiate a fire emergency via the keypad, simultaneously press and hold the [4] and [6] keys for 2 seconds.

**45 – Keypad Panic**

This event type will cause the output to operate when a silent or audible panic alarm has been initiated from the keypad. The output will reset when the system or area is disarmed.

To initiate a panic emergency via the keypad, simultaneously press and hold [1] and [3] keys.

**46 – Device Tamper**

This event type will cause the output to operate when the tamper circuit on the rear of the keypad is triggered. The output will reset when a valid user PIN is entered.

**47 – Access Denied**

This event type will trigger if you attempt to enter an incorrect code more times than programmed in the pin retry count location. The event assignment will be the area number for this event type.

**48 – Strobe**

This event type is used to operate a strobe warning light. The output can be made to operate when any of the following events occur. At least one strobe event must be selected for this output type to operate. See MENU 2-1-5 — Strobe Trigger option.

Strobe trigger options include:

- ❖ = Audible Burglary Alarm
- ❖ = Silent Burglary Alarm
- ❖ = Fire Alarm
- ❖ = Arm/Disarm Flash Via RF Keyfob
- ❖ = Arm/Disarm Flash Via Keypad or PGM Input
- ❖ = 24-Hour Alarm

**49 – Smoke Sensor GND**

This output is used to allow smoke detectors to be automatically reset when the system is disarmed. You should connect the GND terminal of all smoke detectors in the system to outputs which are set to this event type.

For this output type to perform correctly you should program the output polarity as type 11 - Normally Low One Shot Open and program the output time parameter to be 5 seconds. The smoke sensor needs to be connected to a zone input programmed as fire.

If fire alarm verification is required, we recommend that you program the zone pulse count to 2 pulses and the pulse count time to 90 seconds for each fire zone.

**50 – Sensor Watch**

This event type will cause the output to operate when a zone sensor watch fault has occurred. The output will reset when the system or area is armed. See MENU 3-1-8 — Zone Options in Section 7 - Input Programming for more information on Sensor Watch.

**51 – Senior Watch**

This event type will cause the output to operate when a Senior Watch fault has occurred. See MENU 2-1-2 — Input Options in Section 6 - Area Programming for more information on Senior Watch.

**52 – Exit Error**

This event type will cause the output to operate when a Entry/Exit Delay zone becomes unsealed during exit time and remains unsealed when the exit time expires. The output will reset when the system is disarmed.

**53 – Keyfob Function 1**

This event type will cause the output to operate when Key X is pressed on the Keyfob. This output type is area specific and requires a 4 button keyfob.

**54 – Keyfob Function 2**

This event type will cause the output to operate when Key Y is pressed on the Keyfob. This output type is area specific and requires a 4 button keyfob.

**55 – Output In PreDelay**

This event type will cause the output to operate when a pre-delay timer is active on a different output set with a polarity type of 01 (Normally Open, Going Low With Pre Delay) or polarity type 08 (Normally Low, Going Open With Pre Delay).

**56 – Follow PIN Code**

This event type will cause the output to operate when a specified user PIN is entered via the keypad or when the corresponding user's keyfob or token is used.

You should program the User whose PIN is to be followed into the Event Assignment for this output.

**57 – Part Entry Time**

This event type will cause the output to operate when the Part Entry timer is active and will reset when Part Entry time expires.

**58 – TimeZones**

This event type will cause the output to operate when a specific time zone occurs. The output event assignment programs which time zone to follow.

**59 – Temperature Hi/Lo**

This event type will cause the output to operate when the keypad temperature increases above the maximum or falls below the minimum set temperature. The output will reset when the temperature reads between the maximum and minimum values.

See MENU 7-7-3 — Keypad Hi/Lo Temp in Section 11 - System Programming

**60 – Door**

This event type will cause the output to operate when a user assigned to the same door swipes their token. The prox reader must be assigned to the same door group as the output and user.

The Event Assignment is the Access Group Number.

**61 - Door Open Too Long**

This output will turn on when the control panel has detected that the zone assigned to the door has not returned to normal before the end of the door open too long time.

**71 - CLI Trigger**

The output will turn on when the control panel has detected an incoming call with a telephone number programmed in Trigger Table 1 or Trigger Table 2.

**71 - GSM Signal Lost**

The output is triggered whenever the radio is not registered on the GSM network and restores automatically on exiting programming mode or when the radio resumes its connection with the network.

**73 - GPRS Failure**

The output is triggered when communication to the GPRS network is lost and data can no longer be transferred between the radio and the APN (Access Point Name). It restores automatically on exiting programming mode or once data transmission resumes between the radio and the APN.

**74 - Ethernet Fail**

Outputs &gt; Properties &gt;

## Event Assignment

I MENU 4-1-2

0 0 0

- (A) = **Area Assignment**  
Assign to Area 1 to 8 (0 = Any Area)
- (P) = **Control Panel**
- (O) = **Output Assignment**  
Assign to Output 1 to 40 (0 = Any Output)
- (Z) = **Zone Assignment**  
Assign to Zone 1 to 144 (0 = Any Zone)
- (U) = **User Assignment**  
Assign to User 1 to 255 (0 = Any User)
- (TZ) = **TimeZone Assignment**  
Assign to TimeZone 1 to 16 (0 = Any TimeZone)
- (Dr) = **Door Assignment**  
(Assign to Door 1 to 16 (0 = Any Door))
- Keypad Assignment**
- (K) = Assign to Keypad/LAN Reader 1 to 16 (0 = Any Keypad/  
LAN Reader)
- (T) = **CLI Table Assignment**  
Assign to CLI Table 1 to 2 (0 = Any CLI Table)
- (D) = **Reporting Destination Assignment**  
Assign to Destination 1 or 2 (0 = Any Destination)
- (CLI) **CLI Trigger Table**  
Assign to CLI Trigger Table 1 or 2 (0 = Both Tables)
- (Mac) **Macro**  
Assign to Macro

This menu allows you to assign the output event to an individual area, user, zone or door etc. Programming a zero will assign the output event to follow any area, user, zone or door etc depending on the event type.

Refer to Output Event Type Table for a complete listing of available options.

- 1) Press [MENU] + [4] + [1] + [2] and select the output you want to operate from the list then press [OK]. Alternatively, you can directly enter the output number then press [OK]. The keypad will display the current Event Assignment.

```
Event Assignment Op1
00 - All Areas
Press ▲▼ 0-9 OK to SAVE
```

- 2) Use the up and down arrow keys to select the Output Event Assignment then press [OK] to save and exit or press [MENU] to exit without saving.

Outputs &gt; Properties &gt;

## Output Polarity

I MENU 4-1-3

0 0

- |                           |                            |
|---------------------------|----------------------------|
| 00 - Open To Low          | 08 - Low To Open + Pre     |
| 01 - Open To Low + Pre    | 09 - Low Latching Open     |
| 02 - Open Latching Low    | 10 - Low Pulsing Open      |
| 03 - Open Pulsing Low     | 11 - Low 1 Shot Open       |
| 04 - Open 1 Shot Low      | 12 - 1 Shot Open+Retrigger |
| 05 - 1 Shot Low+Retrigger | 13 - 1 Shot Open + Reset   |
| 06 - 1 Shot Low + Reset   | 14 - Speaker Output        |
| 07 - Low To Open          | 15 - Toggle                |

The output polarity programs how the output will operate. Only one option (0 – 15) can be programmed per output. See the Output Polarity description for more detailed information.

- 1) Press [MENU] + [4] + [1] + [3] and use the up and down arrows to highlight the output in the list and press [OK]. The keypad will display the current output polarity.

```
Output Polarity Op1
14 - Speaker Output
Press ▲▼ 0-9 OK to SAVE
```

- 2) Use the up and down arrow keys to select the Output Polarity required then press [OK] to save and exit or press [MENU] to exit without saving.

**Open To Low**

Output is normally open circuit and switches to GND when the event occurs. The output will reset when the output event restores. Time parameters do not apply to this polarity type.

**Open To Low + Pre**

Output is normally open circuit and switches to GND when the event occurs provided the time parameter has expired. The output will reset when the output event restores. Time parameters will only set the Pre Delay when this polarity is selected.

**Open Latching Low**

Output is normally open circuit and will switch to zero volts when the event occurs. The output can only be reset manually using the Output Command Menu.

**Open Pulsing Low**

Output is normally open circuit and will pulse LOW when the event occurs. The output will reset when the output event restores. Use the Time Parameter to set the pulse duration.

**Open 1 Shot Low**

Output is normally open circuit and switches to GND when the event occurs. The output will only reset when the time specified in the Time Parameter expires. The output will run for the full duration and cannot be manually reset.

**1 Shot Low+Retrigger**

Output is normally open circuit and switches to GND when the event occurs. The output will retrigger each time the event occurs. The output will reset when the one shot time has expired.

This polarity is ideally suited for security lighting control. A sensor can be used to trigger an output event and then each time the sensor triggers, the output will operate. The light will turn off when the one shot timer expires.

**1 Shot Low + Reset**

Output is normally open circuit and will switch to GND when the event occurs. The output will reset when the one shot timer expires or when the event has restored. This means the operation of the output can be shortened based on the event and or the programmed time parameter.

**Low To Open**

Output is normally GND and will switch to open circuit when the event occurs. The output will reset when the output event restores. Time parameters do not apply to this polarity type.

**Low To Open + Pre**

Output is normally GND and will switch to open circuit when the event occurs provided the time parameter has expired. The output will reset when the output event restores. Time parameters will only set the Pre Delay when this polarity is selected.

**Low Latching Open**

Output is normally GND and will switch to open circuit when the event occurs. The output can only be reset manually using the output Command Menu.

**Low Pulsing Open**

Output is normally LOW and will pulse OPEN when the event occurs. The output will reset when the output event restores. Use the Time Parameter to set the pulse duration.

**Low 1 Shot Open**

Output is normally LOW and will switch to open circuit when the event occurs. The output will only reset when the time specified in the Time Parameter expires. The output will run for the full duration and cannot be manually reset.

**1 Shot Open+Retrigger**

Output is normally LOW and will switch to open circuit when the event occurs. The output will retrigger each time the event occurs. The output will reset when the one shot time has expired.

**1 Shot Open + Reset**

Output is normally LOW and will switch to open circuit when the event occurs. The output will reset when the one shot timer expires or the event has restored. This means the operation of the output can be shortened based on the event and or the programmed time parameter.

**Speaker Output**

This polarity can only be used for Output 1 and Output 2 when a horn speaker has been connected.

**Toggle**

This polarity allows the output to turn on when the event occurs. The output will toggle off when the event occurs again. This polarity does not follow any time parameters.

**TIMED OUTPUTS**

Outputs > Properties >

Time Parameter				I	MENU 4-1-4
0 0 0	0 0 0	0 0 0	0 0 0		
Hour	Minute	Seconds	10 <sup>th</sup> Sec		

The time base parameter is only applicable for output types that are programmed as one shot or pulsing. Program 0 to 255 for each of the units (Hour, Minute, Seconds and 10th of a Second) for the time parameter. If required, add the units together to give the total one shot time or pulsing on/off time.

- 1) Press [MENU] + [4] + [1] + [4] and select the output you want to program from the list then press [OK]. Alternatively, you can directly enter the output number then press [OK].
- 2) Using the numeric keys, enter the length of time for each parameter. If required, use the [←] and [→] keys to move the cursor left and right between each time parameter.

Output Timing Op1			
Hrs	Mins	Sec	Tenth
000	005	000	000
Press ◀▶▲▼ OK to SAVE			

- 3) Press [OK] to save and exit or press [MENU] to exit without saving.

## One Shot Mode

The time base is the length of time that the output will operate. For Example you may want a strobe output to operate for 1 hour, Either of the examples below will achieve the 1 hour time.

Total Time	Hour	Minute	Seconds	10th Sec
60 Minutes	001	000	000	000
60 Minutes	000	060	000	000

Table 22: Example - Output One Shot Timer

## Pulsing Mode

The time base is the unit of time that the output will pulse on and off. If the time base is programmed for 60 seconds, the output will pulse on for 60 seconds and then off for 60 seconds (repeat) until the output is reset.

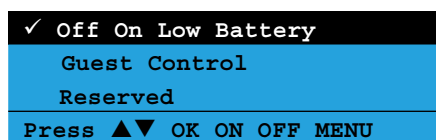
Outputs > Properties >

### Output Options

**I** MENU 4-1-5

1	Off On Low Battery	Y
2	Guest Control	N
3	Reserved	N
4	Monitor Overload	Y
5	Monitor Device Fail	Y
6	Alarm On Device Fail	N
7	Block If All On	N
8	Show Status On Keypad	N

- 1) Press [MENU] + [4] + [1] + [5] and select the output you want to program from the list then press [OK]. Alternatively, you can directly enter the output number then press [OK].
- 2) Use the up and down arrow keys to highlight the option then press the [ON] key to enable or the [OFF] key to disable.



- 3) Repeat Step 2 until all options are programmed as required, then press [OK] to save and exit or press [MENU] to exit without saving.

**Off On Low Battery** This option forces the control panel not to operate the output when a low battery or missing battery condition is in effect. Once the low battery condition restores, the output will return to normal operation.

## Guest Control

Guest control when enabled allows the output to be controlled from the quick select menu on the keypad which is a simple pull down menu. This allows you to

view and alter the state of the output without the need of a PIN. To simply turn on or off guest control outputs, press the [←] key.

## Monitor Overload

Monitor Overload when selected will monitor the output for an overload condition and display as well as report if an overload condition occurs. The event will always be logged regardless if enabled or not.

## Monitor Device Fail

Monitor device fail when selected will monitor the output for a disconnection condition and display as well as report when a disconnection occurs.

## Alarm On Device Fail

This option causes the panel to sound an alarm when the output device becomes missing (armed or disarmed state).

## Block If All On

This option prevents the output from turning on when the corresponding area is turned All On. When the area is off, Part On or Part 2 On, the output can again operate when the output event occurs.

## Show Status On Keypad

This option allows the keypad to display the output that is currently active on the keypad.

Outputs > Properties >

### Macro Group

**I** MENU 4-1-6

Reserved

**DOOR CONTROL**

Outputs &gt; Door Properties &gt;

Door Name I-M MENU 4-2-0

D o o r 1 N a m e

This menu allows you to program the name for each output. Door names can be up to 20 characters long.

- 1) Press [MENU] + [4] + [2] + [0] and use the up and down arrows to highlight the door in the list then press [OK]. Alternatively, you can enter the door number directly and press [OK].
- 2) Use the arrow and number keys to move and change text. When the door name is complete, press [OK]. At any time you can press the [OFF] key to clear the text from the current cursor position to the end of the line. .

```
Door Name Dr1
Door 1 Name
Press ◀▶▲▼ OK to SAVE
```



See *Alpha Text Programming in Section 4 — Programming Overview* for further detail on entering alpha text.

Outputs &gt; Door Properties &gt;

**Unlock TimeZone**I MENU 4-2-2

0 0

```
00 - Disabled
01 - 24 Hour TimeZone
02 - TimeZone 2 Name
03 - TimeZone 3 Name
04 - TimeZone 4 Name
05 - TimeZone 5 Name
06 - TimeZone 6 Name
07 - TimeZone 7 Name
08 - TimeZone 8 Name
09 - TimeZone 9 Name
10 - TimeZone 10 Name
11 - TimeZone 11 Name
12 - TimeZone 12 Name
13 - TimeZone 13 Name
14 - TimeZone 14 Name
15 - TimeZone 15 Name
16 - TimeZone 16 Name
```

The unlock timezone is used to control the output which is assigned to operate the door lock. When the timezone is true, the output assigned to the corresponding door will be activated. Options area provided to stop the door from automatically operating if an area is armed or no users on site. The list of doors will appear, move the cursor over the door you wish to select and press the OK key.

- 1) Enter [MENU] + [4] + [2] + [2]. The list of doors will appear, move the cursor over the door you wish to select and press the [OK] key.

```
Unlock TimeZone Dr1
00 - Disabled
Press ▲▼ 0-9 OK to SAVE
```

- 2) Use the arrow or number keys to select the time zone that you want the door to follow, then press [OK] to save and exit.

Outputs &gt; Door Properties &gt;

**Door Options****I** MENU 4-2-3

1	Hold Off If Area Armed	Y
2	Hold Off Auto Unlock	N
3	Reserved	N
4	Report Door Forced	N
5	Alarm Door Forced	N
6	Reserved	N
7	Reserved	N
8	Reserved	N

- 1) Press [MENU] + [4] + [2] + [3] and select the door you want to program from the list then press [OK]. Alternatively, you can directly enter the door number then press [OK].
- 2) Use the up and down arrow keys to highlight the option, then press the [ON] key to enable or the [OFF] key to disable.

```

✓ Hold Off If Area Armed
  Hold Off Auto Unlock
  Release On Fire Alarm
Press ▲▼ OK ON OFF MENU

```

- 3) Repeat Step 2 until all options are programmed as required, then press [OK] to save and exit or press [MENU] to exit without saving.

**Hold Off If Area Armed**

This option when enabled and used in conjunction with a timezone assigned under the door control menu will stop the door from unlocking if the area behind the door is armed. This is very useful in cases where the holiday list may not have been kept up to date.

**Hold Off Auto Unlock**

This option when selected will delay the automatic unlocking until a valid user has presented his card after the timezone unlocking (gate opening) time..

**Report Door Forced**

This option when turned on will enable the Door Forced Open event to be reported as an access event. It will also appear in the keypad display as an alarm condition identifying the door 'ALARM Door 1 Name'.

**Alarm Door Forced**

This option when turned on will enable the Door Forced Open event to cause an alarm condition and sound the alarm sirens. It will also appear in the keypad display as an alarm condition identifying the door 'ALARM Door 1 Name'. To silence this alarm, you must enter a valid PIN at the keypad.

**OUTPUT TESTING**

Outputs &gt; Output Testing &gt;

**External Siren Test****I-M** MENU 4-9-0

This menu allows you to test the operation of any output programmed as event type 36 (External Audible) or Event Type 36 (Fire Alarm) for 5 seconds.

- 1) Enter [MENU] + [4] + [9] + [0] and select the area you want to test the external sirens in from the list then press [OK].

```

A1 Security System
A2 Area 2 Name
A3 Area 3 Name
Press ▲▼ OK or MENU

```

- 2) Any outputs programmed for event type 36 or 39 in the chosen area will now operate. The keypad will display the following during the siren test.

```

External Audible Testing
Press any key to abort

Press OK or MENU

```

- 3) When the siren test is complete, the keypad will display the following:

```

Testing Complete. Press
OK to continue

Press OK or MENU

```

- 4) Press [OK] to exit.

## Outputs &gt; Output Testing &gt;

## Internal Siren Test

I-M MENU 4-9-1

This menu allows you to test any output programmed as event type 37 (Internal Audible) or event type 39 (Fire Alarm) for 5 seconds.

- 1) Enter [MENU] + [4] + [9] + [1] and select the area you want to test the internal sirens in from the list then press [OK].

```
A1 Security System
A2 Area 2 Name
A3 Area 3 Name
Press ▲▼ OK or MENU
```

- 2) Any outputs programmed for event type 37 or 39 in the chosen area will now operate. The keypad will display the following during the siren test.

```
Internal Audible Testing
Press any key to abort
Press OK or MENU
```

- 3) When the bell test is complete, the keypad will display the testing complete message.

```
Testing Complete. Press
OK to continue
Press OK or MENU
```

- 4) Press [OK] to exit.

## Outputs &gt; Output Testing &gt;

## Strobe Test

I-M MENU 4-9-2

This menu allows you to test the any outputs programmed as event type 48, Strobe light. This test is not timed and needs to be manually stopped when testing is completed.

- 1) Enter [MENU] + [4] + [9] + [2] and select the area you want to test the strobe lights in from the list then press [OK].

```
A1 Security System
A2 Area 2 Name
A3 Area 3 Name
Press ▲▼ OK or MENU
```

- 2) Any outputs programmed for event type 48 in the chosen area will now operate. The keypad will display the following during the strobe test.

```
Strobe Activated. Will
reset on exit
Press OK or MENU
```

- 3) Check and verify that the strobe lights are working correctly then press [OK] to end the test.

## Outputs &gt; Output Testing &gt;

## Fire Siren Test

I-M MENU 4-9-3

This menu allows you to test any output programmed as event type 39 (Fire Alarm) for 5 seconds.

- 1) Enter [MENU] + [4] + [9] + [3] and select the area you want to test the internal sirens in from the list then press [OK].

```
A1 Security System
A2 Area 2 Name
A3 Area 3 Name
Press ▲▼ OK or MENU
```

- 2) Any outputs programmed for event type 39 in the chosen area will now operate. The keypad will display the following during the siren test.

```
Fire Audible Testing
Press any key to abort
Press OK or MENU
```

- 3) When the bell test is complete, the keypad will display the testing complete message.

```
Testing Complete. Press
OK to continue
Press OK or MENU
```

- 4) Press [OK] to exit.



**OUTPUT EVENT TYPE TABLE**

00 - Disabled	P	26 - Entry Timing	A	52 - Exit Error	A
01 - Battery Trouble	P	27 - Exit Timing	A	53 - Keyfob Function 1	A
02 - AC Trouble	P	28 - End Of Exit Time	A	54 - Keyfob Function 2	A
03 - Telco Line Fail	P	29 - Chime On	A	55 - Output In PreDelay	Op
04 - Comm Fail	Rr	30 - Chime Zone Trigger	A	56 - Follow PIN Code	Ur
05 - 3rd Dial Attempt	Rr	31 - Auto Arm Pre Alert	A	57 - Part Entry Time	A
06 - Dest Reporting	Rr	32 - Ready To Arm All On	A	58 - TimeZones	Tz
07 - Disabled		33 - Ready To Part Arm	A	59 - Temperature Hi/Lo	Kp
08 - Dest Kiss Off	Rr	34 - Ready To Part 2 Arm	A	60 - Door	Dr
09 - User Keyfob Func 1	Ur	35 - Close Sent OK	A	61 - Door Open Too Long	Dr
10 - User Keyfob Func 2	Ur	36 - External Audible	A	71 - CLI Trigger	CLI
11 - Dialler Disabled	P	37 - Internal Audible	A	72 - GSM Signal Lost	P
12 - Output Device Missing	P	38 - Any Zone Alarm	A	73 - GPRS Failure	P
13 - Output Trouble	Op	39 - Fire Alarm	A	74 - Ethernet Fail	P
14 - Panel On Line	P	40 - Burglary Alarm	A	75 - Macro	Ma
15 - Incoming Call	P	41 - Silent Alarm	A		
16 - System Trouble	P	42 - Duress Alarm	A		
17 - Box Tamper	Zn	43 - Keypad Medical	A		
18 - Zone Trouble	Zn	44 - Keypad Fire	A		
19 - Zone Mirror	Zn	45 - Keypad Panic	A		
20 - Zone Alarm	A	46 - Device Tamper	A		
21 - Area Disarmed	A	47 - Access Denied	A		
22 - Area Part Or All On	A	48 - Strobe	A		
23 - Area All On	A	49 - Smoke Sensor GND	A		
24 - Area Part On	A	50 - Sensor Watch	A		
25 - Area Part 2 On	A	51 - Senior Watch	A		

**Legend:**

(Ma) = Macro	(CLI) = CLI Trigger Table	(A) = Area Event Assignment
(P) = Panel Event Assignment	(Op) = Output Event Assignment	(Zn) = Zone Event Assignment
(Ur) = User Event Assignment	(Tz) = TimeZone Event Assignment	(Dr) = Door Group Event Assignment
(Kp) = Keypad	(Rr) = Reporting Destination	

**Table 23: Output Event Types**

## OUTPUT ASSIGNMENTS

Output Assignment						
Module Number	Address Setting					Output Number
	SW1	SW2	SW3	SW4	SW5	
Control Panel						1 to 5
Virtual Outputs						6 to 8
1 =	OFF	OFF	OFF	OFF	OFF	9 to 12
2 =	ON	OFF	OFF	OFF	OFF	13 to 16
3 =	OFF	ON	OFF	OFF	OFF	17 to 20
4 =	ON	ON	OFF	OFF	OFF	21 to 24
5 =	OFF	OFF	ON	OFF	OFF	25 to 28
6 =	ON	OFF	ON	OFF	OFF	29 to 32
7 =	OFF	ON	ON	OFF	OFF	33 to 36
8 =	ON	ON	ON	OFF	OFF	37 to 40

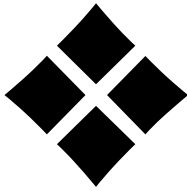
Table 24: Address Configuration and Output Assignments

## OUTPUT DEFAULT TABLE

The table below list the default values for all Output parameters in the Solution 144. Outputs 1 to 4 are High current digital outputs and Output 5 is the onboard relay output. Outputs 9 to 40 are only available if the optional Output Relay Expander Boards (CM710B) are fitted. Options marked N/A = Not Applicable.

Programming Option	Output 1	Output 2	Output 3	Output 4	Output 5	Output 9 - 40
<b>Output Name</b>	<b>External Siren</b>	<b>Strobe Light</b>	<b>Smoke Sensor PWR</b>	<b>Internal Siren</b>	<b>On Board Relay</b>	<b>Output x Name</b>
<b>Event Type</b>	<b>36 (External Siren)</b>	<b>48 (Strobe)</b>	<b>49 (Smoke Sensor GND)</b>	<b>37 (Internal Siren)</b>	<b>54 (Keyfob Function 2)</b>	<b>00 (Not Used)</b>
<b>Event Assignment</b>	<b>0</b>	<b>0</b>	<b>0</b>	<b>0</b>	<b>0</b>	<b>0</b>
<b>Output Polarity</b>	<b>14 Speaker Output</b>	<b>6 1 Shot Low + Reset</b>	<b>11 Low 1 Shot Open</b>	<b>6 1 Shot Low + Reset</b>	<b>4 Open 1 Shot Low</b>	<b>0 Open To Low</b>
<b>Time Parameter</b>						
<b>N° Of Hours</b>	<b>000</b>	<b>008</b>	<b>000</b>	<b>000</b>	<b>000</b>	<b>000</b>
<b>N° Of Minutes</b>	<b>005</b>	<b>000</b>	<b>000</b>	<b>005</b>	<b>000</b>	<b>000</b>
<b>N° Of Seconds</b>	<b>000</b>	<b>000</b>	<b>010</b>	<b>000</b>	<b>002</b>	<b>000</b>
<b>N° Of 1/10 Seconds</b>	<b>000</b>	<b>000</b>	<b>000</b>	<b>000</b>	<b>000</b>	<b>000</b>
<b>Output Options</b>						
<b>Off On Low Battery</b>	<b>Y</b>	<b>Y</b>	<b>N</b>	<b>Y</b>	<b>N</b>	<b>N</b>
<b>Guest Control</b>	<b>N</b>	<b>N</b>	<b>N</b>	<b>N</b>	<b>N</b>	<b>N</b>
<b>Reserved</b>	<b>N</b>	<b>N</b>	<b>N</b>	<b>N</b>	<b>N</b>	<b>N</b>
<b>Monitor Overload</b>	<b>Y</b>	<b>Y</b>	<b>Y</b>	<b>Y</b>	<b>N</b>	<b>N</b>
<b>Monitor Device Fail</b>	<b>Y</b>	<b>Y</b>	<b>N</b>	<b>Y</b>	<b>N</b>	<b>N</b>
<b>Alarm On Device Fail</b>	<b>N</b>	<b>N</b>	<b>N</b>	<b>N</b>	<b>N</b>	<b>N</b>
<b>Block If All On</b>	<b>N</b>	<b>N</b>	<b>N</b>	<b>N</b>	<b>N</b>	<b>N</b>
<b>Show Status On Keypad</b>	<b>N</b>	<b>N</b>	<b>N</b>	<b>N</b>	<b>N</b>	<b>N</b>

Table 28: Output Default Table



# Comms Programming

The control panel has a built in dialler that connects directly to a standard PSTN telephone line. To program the dialler you must set the telephone number to dial and then the reporting format to send the information in.

The command menu allows you to set the Domestic Numbers, initiate a Solution Link Upload / Download session, turn on/off call forwarding.

There are two independent reporting routes that define where a reportable event should be sent, by default all events will report through route 1. Reportable events in the system are categorised into Alarm, System, Emergency, Open/Close and Test. This means that you are able to steer these different event categories to different report routes. A report route is just like an independent dialler, it has its own primary and secondary telephone numbers and reporting format.

### Example: Route 1 = CID, Route 2 = SMS

If you set the reporting route for Open/Close as Route 2 and all other events to Route 1, then all reports will be sent to route 1 in Contact ID format and then all open close reports will be sent through SMS. This is very handy if you want to monitor what time your children come home from school or cleaners entering or leaving your premises.

Telephone numbers can be 32 digits long and characters 0-9\*# and , are supported with the comma representing a 2 second pause. Destination route 1 and route 2 both have their own Primary and Secondary telephone numbers, Domestic reporting has 3 telephone numbers and remote access has one call back number.

There are two back to base monitoring formats called CID and SIA, both formats are all predefined so the system will always send the same reporting code for the same event. The type of zone selected under zone type automatically determines the reporting code to the base station. If a zone is defined as Medical then when it goes into alarm the report will be Medical Alarm, if a zone is programmed as a Fire zone then the report will automatically be Fire Alarm.

## COMMS PROGRAMMING COMMANDS

Comms > Commands >

Call/Answer RAS

**I**-**M**-**U**

**MENU 5-0-1**

This command allows you to initiate a modem call to an off-site computer for programming changes or updates. The off-site computer must be connected to the telephone line that is programmed in the call back telephone number and be set to wait for an incoming call from the same customer that initiates the modem call.

If the phone is ringing and this command is entered, then the panel will answer the call and attempt to start a Solution Link RAS session.

Comms > Commands >

Call Forward On/Off

**I**-**M**

**MENU 5-0-2**

This command allows you to turn on and off the call forward feature. When you turn on call forwarding, the panel will automatically activate and de-activate the call forward on and call forward off sequence accordingly when you turn Area 1 All On and Off (arm and disarm).

- 1) Enter [MENU] + [5] + [0] + [2]. If the call forward status is OFF, the keypad will display:

```
Call Forward On/Off
Call Forward is OFF
To turn ON, Press ON.
To Go Back Press OK
```

If the call forward status is ON, the keypad will display:

```
Call Forward On/Off
Call Forward is ON.
To Turn OFF, Press OFF.
To Go Back Press OK
```

- 2) To toggle call forward on, press the [ON] key or press the [OFF] key to turn call forward off.
- 3) Press [OK] to save and exit, or press [MENU] to cancel.



See MENU 5-1-6 and MENU 5-1-7 to program the Call Forward ON and Call Forward OFF number sequence.

Comms &gt; Commands &gt;

Check Web Email



MENU 5-0-3

Reserved

Comms &gt; Commands &gt;

Email System Log



MENU 5-0-4

Reserved

Comms &gt; Commands &gt;

Start Direct Link



MENU 5-0-5

This menu allows the installer or master user to start a direct link session without the need to press and hold the default button on the control panel.

- 1) Enter [MENU] + [5] + [0] + [5]. The keypad will display the following:

```

Waiting for Direct Link
Attempt!
-----
Press OK or MENU
  
```

Once the computer and control panel establishes a connection, the command will automatically exit.

- 2) Press [OK] or [MENU] to exit.

Comms &gt; Commands &gt;

Voice Setup



MENU 5-0-6

This menu allows the master user to record their own customised greeting and zone description message that will be played back to users that are programmed to receive domestic telephone calls from the alarm system.

These messages should be clear enough so that the user receiving the telephone call from the control panel can then take the appropriate action.

This feature requires an optional voice module to be fitted to the control panel by your installer. Additional programming information is included with the voice module.

When answering an incoming voice call, the operations are as follows:

- [#] Acknowledge single message
- [\*][\*] Acknowledge all messages, hang up and leave in cue for next person.
- [\*] Acknowledge message and leave in the cue for next person
- PIN** Disarm the system and abort all pending voice messages (except Open/Close)
- [OFF]**

### Solution 144 Control Panel

- 1) Press [MENU] + [5] + [0] + [6] + [OK].

Enter the telephone number of the mobile phone you are using to record the messages from. (eg. 0411123456), then press the [OK] key. The alarm system will now call the programmed number. Answer the incoming call on the mobile telephone and you will hear the following message;

Press 1 to play a message,  
2 to record a message  
or 3 to end.

- 2) The alarm keypad will display the available options on the display awaiting your selection. Using the alarm keypad enter the number corresponding to the operation you want to perform.

```

Play Message
Record Message
Exit
-----
PRESS ▲▼ OK or MENU
  
```

- 3) Press [1] on the alarm keypad to playback and listen to a message, or press [2] to record a new message.

## Playing Back A Message

- 4) The system will then prompt you to Enter the message number followed by the [OK] key. Enter the message number on the alarm keypad and press the [OK] key.

```
Zone 1 Message
Zone 2 Message
Zone 3 Message
Press ▲▼ OK or MENU
```

Alternatively, you can use the [UP] and [DOWN] keys to scroll to the message required, then press [OK] to select.

Refer to the voice module instruction sheet for a complete list of the message numbers.

The keypad will display the following below whilst playing the current recorded message via the telephone.

```
Playing
Zone 1 Message
Press OK or MENU
```

- 5) After the message has been played, the system will automatically return to the main menu as shown in step 5 above.

## Recording New Messages

To record a new message, follow the instructions in steps 1 to 3 above and then,



*For the best results when recording messages speak loudly and clearly into the mobile phone and reduce as much background noise as possible. We do not recommend recording using hands free operation.*

- 4) The system will then prompt you to Enter the message number followed by the [OK] key. Enter the message number on the alarm keypad and press the [OK] key.

```
Zone 1 Message
Zone 2 Message
Zone 3 Message
Press ▲▼ OK or MENU
```

Alternatively, you can use the [UP] and [DOWN] keys to scroll to the message required, then press [OK] to select.

Refer to the voice module instruction sheet for a complete list of the message numbers.

- 5) On the mobile phone you will hear a short beep indicating that recording has begun. You should now speak clearly into the mobile phone to record the new message as required and press [OK] when finished.

```
Recording
Zone 1 Message
Press OK or MENU
```

If the message duration expires before you finish recording you will hear a long beep indicating that recording has finished. If this happens you may need to speak a little faster when recording or shorten the actual message to fit in the available message space.

- 6) You should now follow the instructions to playback the message. When you are happy with the newly recorded message repeat the steps to customise the remaining messages. If you would like to overwrite or re-record the same message again simply repeat the appropriate steps until you are satisfied.



*Currently it is not possible to reset the programmable messages back to the factory default settings.*

Comms > Commands >

Register Customer | I-M MENU 5-0-8

Reserved

Comms > Commands >

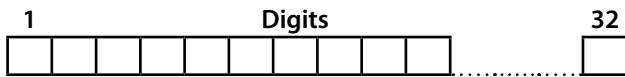
Register Installer | I MENU 5-0-9

Reserved

**PHONE NUMBER PROGRAMMING**

Comms > Telephone Numbers >

Number Prefix | I MENU 5-1-0



The number prefix allows you to program the customer account number and pass code (PIN) to access the telephone line exchange when using a pre-paid telephone account (e.g. Telstra Communic8 Pre-Paid Home account), or when a number followed by a pause is required to get an outside line on a PABX system.

The number prefix is global for all telephone numbers programmed in both Destination 1 and Destination 2 (including the domestic telephone numbers and call forward sequences). the prefix will be dialled immediately before the number.

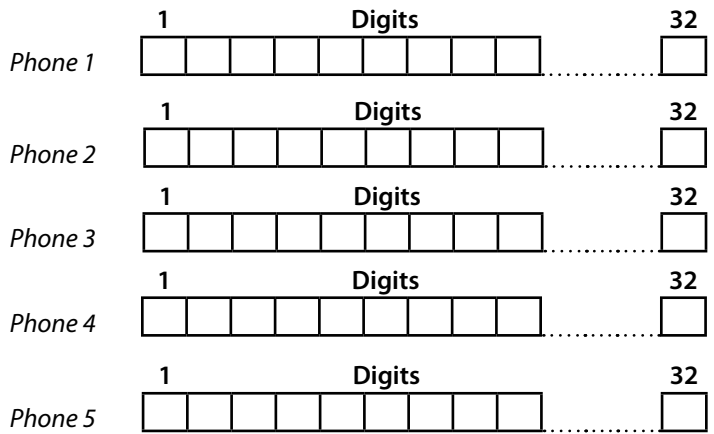
- 1) Enter [MENU] + [5] + [1] + [0]. The keypad will display the current Telco Number Prefix.



- 2) Using the numeric keys, enter all the digits of the telephone number prefix. You can change a single digit by scrolling the cursor left or right. For special characters including, pause, \* or #, use the up and down arrow keys.
- 3) Press [OK] to save and exit or press [MENU] to exit without saving.

Comms > Telephone Numbers >

Destination 1 | I-M MENU 5-1-1

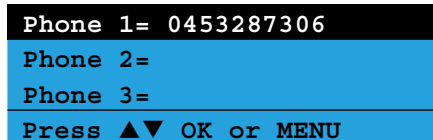


This menu sets the primary telephone number for Report Destination 1. This will typically be the primary base station receiver number. The master code user can only change telephone numbers when the destination is set to report in domestic format, voice format or SMS format.

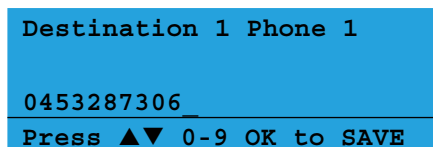
- 1) Enter [MENU] + [5] + [1] + [1].  
If the control panel is not programmed to report using one of the self monitoring formats, the keypad will display the following:

Reporting format does not allow user changes. Contact installer for further information

- 2) If the control panel has been configured to report via a self monitoring format, the keypad will display information for telephone number 1.



- 3) Use the [↑] and [↓] keys to select the phone number to add or change, then press [OK] to select.  
The keypad will display the following:



- 4) Use the [←] and [→] keys to scroll the cursor left and right across the phone number. Use the [↑] and [↓] keys to change the individual digit in the number or press the [OFF] key to clear the whole number and then enter the new number using the [0]-[9] keys.

- 5) Press [OK] to save and exit, or press [MENU] to cancel.

Comms > Telephone Numbers >

**Destination 2**

**I-M MENU 5-1-2**

	1	Digits								32
Phone 1										
Phone 2										
Phone 3										
Phone 4										
Phone 5										

This menu sets the primary telephone number for Report Destination 2. This will typically be the primary base station receiver number. The master code user can only change telephone numbers when the destination is set to report in domestic format, voice format or SMS format.

- 1) Enter [MENU] + [5] + [1] + [2].

If the control panel is not programmed to report using one of the self monitoring formats, the keypad will display the following:

Reporting format does not allow user changes. Contact installer for further information

- 2) If the control panel has been configured to report via a self monitoring format, the keypad will display information for telephone number 1.

Phone 1= 0453287306  
 Phone 2=  
 Phone 3=  
 Press ▲▼ OK or MENU

- 3) Use the [↑] and [↓] keys to select the phone number to add or change, then press [OK] to select.

The keypad will display the following:

Destination 2 Phone 1  
 0453287306  
 Press ▲▼ 0-9 OK to SAVE

- 4) Use the [←] and [→] keys to scroll the cursor left and right across the phone number. Use the [↑] and [↓] keys to change the individual digit in the number or press the [OFF] key to clear the whole number and then enter the new number using the [0]-[9] keys.

- 5) Press [OK] to save and exit, or press [MENU] to cancel.

Comms > Telephone Numbers >

**Call Forward On**

**I-M MENU 5-1-6**

1	Digits								32	
	.	6	1	,	*	2	0	#		

The panel is able to activate certain Telco services such as Call Forwarding when the system is armed. Call forwarding means that your customer will no longer need to remember to manually activate the Call Forward On feature via the telephone before leaving.

MENU 5-1-6 allows you to program the Call Forward On number sequence. When armed the panel will automatically seize the phone line and dial the number sequence and then hang up.

In Australia, a typical sequence for activating the Call-Forward On feature (All Calls) might be:

\*61 0416123456 \*20 #

\*61 diversion type - Call Forward On - Immediate.

0416123456 Telephone number that you want calls to be diverted to. Example shows mobile number.

\*20 20 second delay

# end of sequence

- 1) Enter [MENU] + [5] + [1] + [6]. The keypad will display any current Call Forward sequences.

Call Forward On  
 \*61,\*20#  
 Press ◀▶▲▼ OK to SAVE

- 2) Using the numeric keys, enter all digits for the sequence. You can change a single digit by scrolling the cursor left or right. For special characters including, pause, \* or #, use the up and down arrow keys.
- 3) Press [OK] to save and exit or press [MENU] to exit without saving.

Comms &gt; Telephone Numbers &gt;

## Call Forward Off

I-M MENU 5-1-7

1	Digits										32
#	6	1	#								

The panel is also able to deactivate certain Telco services such as Call Forwarding when the system is disarmed. This means that your customer will no longer need to remember to manually deactivate Call Forwarding when they disarm the system.

MENU 5-1-7 allows you to program the Call Forward Off number sequence. When disarmed the panel will automatically seize the phone line and dial the number sequence and then hang up.

In Australia, a typical sequence for deactivating the Call-Forward On feature (All Calls) might be:

#61 #

#61 = diversion type - Call Forward On - Immediate - Disable.

# = end of sequence

- 1) Enter [MENU] + [5] + [1] + [7]. The keypad will display any current Call Forward Off sequences.

```

Call Forward Off
#61#
Press ◀▶▲▼ OK to SAVE
  
```

- 2) Using the numeric keys, enter all digits for the sequence. You can change a single digit by scrolling the cursor left or right. For special characters including, pause, \* or #, use the up and down arrow keys.
- 3) Press [OK] to save and exit or press [MENU] to exit without saving.

## COMMS PROPERTIES

Comms &gt; Properties &gt;

## Call Attempt Count

I MENU 5-2-0

0	6
---	---

This menu programs the maximum number of call attempts the panel will make per destination in order to deliver the report signal.

At factory default, the maximum number of call attempts per event is 6 when reporting to a single destination and 12 attempts when reporting to 2 destinations. (6 attempts per destination)

- 1) Press [MENU] + [5] + [2] + [0]. The keypad will display the current number of call attempts per destination. (Default = 6).

```

Call Attempt Count
6
Press 0-9 OK to SAVE
  
```

- 2) Using the numeric keys, enter the required number of call attempts per destination. Valid entries are 1 to 10. 0 = reporting disabled
- 3) Press [OK] to save and exit or press [MENU] to exit without saving.



Setting the Call Attempt count to zero will disable all reporting for Destination 1 and Destination 2

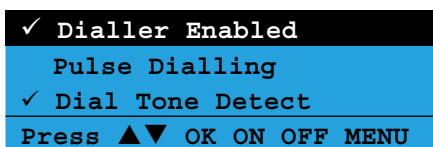


Comms &gt; Properties &gt;

**Dialler Options** MENU 5-2-1

1	Dialler Enabled	Y
2	Pulse Dialling	N
3	Dial Tone Detect	Y
4	Busy Tone Detect	N
5	Mirror Report To Web	Y
6	Extend H/S To 1min	N
7	Reserved	N
8	Abort Failed Reports	Y

- 1) Press [MENU] + [5] + [2] + [1]. The keypad will display the current Dialler Options.



- 2) Use the up and down arrow keys to highlight the option then press the [ON] key to enable or the [OFF] key to disable.
- 3) Repeat Step 2 until all options are programmed as required, then press [OK] to save and exit or press [MENU] to exit without saving.

**Dialler Enabled**

This option enables the dialler reporting function. When disabled, all dialler reporting will stop.

**Pulse Dialling**

This option will configure the panel to use pulse or decadic dialling rather than tone or DTMF dialling. DTMF dialling should always be used unless the telephone network you are communicating on does not support it.

**Dial Tone Detect**

This option configures the panel to start dialling as soon as it detects dial tone on the line. This can speed up the dialling process by up to 3 seconds. If no tone is detected the panel will blind dial after 4 seconds.

If this option is disabled the panel will blind dial.

**Busy Tone Detect**

This option configures the panel to detect busy tone. If a busy tone is detected during the dialling sequence, the panel will immediately hang up and move on to the next number in the sequence in an attempt to get the report through as quickly as possible.

If this option is disabled, the panel will wait for a period of 30 seconds before dialling the next telephone number in the sequence. The 30 second timer starts when the first digit of the first telephone number is dialled.

**Mirror Report WEB**

Reserved.

**Extend H/S To 1min**

This option sets the panel to wait for up to 60 seconds to receive a valid handshake signal from the base station receiver. The handshake tone indicates to the panel that it has reached the security company's base station receiver and can now send it's pending reports.

If this option is disabled the handshake wait time will default to 30 seconds.

**Abort Failed Reports**

Setting this option will cause a failed report to be flagged in the log and no further reports will be made for that event.



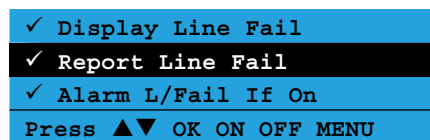
*A report will be failed if the number of programmed dial attempts has been reached.*

Comms &gt; Properties &gt;

**Phone Line Options** MENU 5-2-2

1	Display Line Fail	Y
2	Report Line Fail	Y
3	Alarm L/Fail If On	Y
4	Alarm L/Fail If Off	N
5	Reserved	N
6	Reserved	N
7	Reserved	N
8	Display On Line	N

- 1) Press [MENU] + [5] + [2] + [2]. The keypad will display the current Phone Line Options.



- 2) Use the up and down arrow keys to highlight the option then press the [ON] key to enable or the [OFF] key to disable.
- 3) Repeat Step 2 until all options are programmed as required, then press [OK] to save and exit or press [MENU] to exit without saving.

**Display Line Fail**

This option sets the panel to display a trouble signal on the keypad display when the panel detects a telco line fail condition.

**Report Line Fail**

This option sets the panel to send a line fail report when it detects a telco line fail condition. If configured,

the panel is able to report this signal via an alternative reporting method such as the GSM cellular network.

If no alternative route exists then the panel will send the signal and restore when the PSTN line is reconnected.

### Alarm L/Fail If On

This option sets the panel to trigger an alarm when the telco line fails provided that the area is turned All On or Part On. In a multi-area system this option is global and will be triggered if only one area in the system is in the armed state. The alarm will continue to sound until a valid PIN is entered or the siren timer expires.

### Alarm L/Fail If Off

This option sets the panel to trigger an alarm when the telco line fails provided that the area is turned OFF or disarmed. In a multi-area system this option is global and will be triggered if only one area in the system is in the disarmed state. The alarm will continue to sound until a valid PIN is entered or the siren timer expires.

### Display On Line

This option allows the keypad to display Phone In Use when the telephone line has been looped by the control panel for either incoming or outgoing calls. If this option is disabled, no indication is provided on the keypad.



*The dialler status indicator LED located on the main panel will always show the status of the dialler. See Section 3 - Wiring Diagrams for more information.*

Comms > Properties >

### Country



MENU 5-2-3

(\*\*\* System Wide Parameter \*\*\*)

0 1

Ln1 AUSTRALIA	Ln9 CZECH REPUBLIC
Ln2 NEW ZEALAND	Ln10 POLAND
Ln3 ITALY	Ln11 TURKEY
Ln4 GREECE	Ln12 CHINA
Ln5 CYPRUS	Ln13 HONG KONG
Ln6 SPAIN	Ln14 MALAYSIA
Ln7 PORTUGAL	Ln15 BRAZIL
Ln8 HUNGARY	

This menu automatically sets the dialling parameters including dial and busy tones etc. for the country the panel is working in.

- 1) Press [MENU] + [5] + [2] + [3]. The keypad will display the currently selected country. The default country is Australia.
- 2) Use the up and down arrow keys to select the appropriate country then Press [OK].



- 3) Press [OK] to confirm and save and exit or press [MENU] to exit without saving.

WARNING: Press OK to set dialler to AUSTRALIA



*For correct dialler operation, you must make sure that the correct country selection is made for your location. If your country is not listed here please contact your distributor.*



Comms &gt; Remote Access &gt;

**RAS Security PIN****I** MENU 5-3-1

1	2	3	4	5	6	7	8
---	---	---	---	---	---	---	---

The RAS security PIN programmed here must match the security PIN programmed in the customer file of the Solution Link RAS upload/download database otherwise a connection to the panel cannot be established.

- 1) Press [MENU] + [5] + [3] + [1]. The keypad will display the current RAS Security PIN. The default = 12345678.

```

RAS Security PIN
12345678
Press ◀▶▲▼ OK to SAVE
  
```

- 2) Using the numeric keys, enter all the digits of the new RAS security PIN. You can change a single digit by scrolling the cursor left or right.
- 3) Press [OK] to save and exit or press [MENU] to exit without saving.

Comms &gt; Remote Access &gt;

**Log Threshold****I** MENU 5-3-2

7	0	%
---	---	---

The control panel can store up to 256 system events in its built in history log. A newly installed panel will have 100% of its log space available for new events (0% full). As the panel starts to store events in the log, the capacity for new events is reduced. The history log is 100% full when event 256 is stored in memory. Event 257 will start to overwrite the oldest events in the log.

When the Log Threshold option is programmed, the panel will send a 'Log Threshold' report to the base station when the event log reaches the percentage as set since the last Solution Link session.

If the event log reaches 100% capacity before a Solution Link RAS session is established then the system will send a 'Log Overflow' report. The panel will also log these events in its memory.

- 1) Press [MENU] + [5] + [3] + [2]. The keypad will display the current threshold limit. The default is 70% full.

```

Log Threshold
070 Percents
Press 0-9 OK to SAVE
  
```

- 2) Using the numeric keys enter the new threshold limit, then press [OK] to save and exit or press [MENU] to exit without saving. There is no need to enter the % symbol.



Each time a Solution Link RAS session is established with the panel, the log information will be uploaded to the Solution Link database where it can be reported on or archived for later use

Comms &gt; Remote Access &gt;

**Ring Count****I** MENU 5-3-3

00 - No Answer

2	0
---	---

01 to 30 - Answer Ring Count

This menu sets the number of rings the panel will wait until answering an incoming call. Programming a zero will stop the panel from answering any incoming calls.

- 1) Press [MENU] + [5] + [3] + [3]. The keypad will display the current ring count.

```

Ring Count
20-20 Rings
Press ▲▼ 0-9 OK to SAVE
  
```

- 2) Use the up and down arrow keys to select the required ring count then Press [OK] to save and exit or press [MENU] to exit without saving.



If answering machine bypass is required to allow a Solution Link connection to be made without the answering machine answering the call, see MENU 5-3-4 — Solution Link RAS Options

Comms &gt; Remote Access &gt;

**RAS Options****I** MENU 5-3-4

1	RAS Allowed	Y
2	Callback Verify	N
3	Abort RAS On Alarm	Y
4	Answer Bypass	Y
5	Answer Only If Armed	N
6	Tone Bypass	Y
7	Allow User Functions	Y
8	Report RAS Sessions	Y

- 1) Press [MENU] + [5] + [3] + [4]. The keypad will display the current RAS options.

```

✓ RAS Allowed
  Callback Verify
✓ Abort RAS On Alarm
Press ▲▼ OK ON OFF MENU
  
```

- 2) Use the up and down arrow keys to highlight the option then press the [ON] key to enable or the [OFF] key to disable.
- 3) Repeat Step 2 until all options are programmed as required, then press [OK] to save and exit or press [MENU] to exit without saving.

## RAS Allowed

This option allows you to configure the panel via the Solution Link RAS upload/download software using a PC.

There are two different methods of connection available;

- 1) **Direct Connect – via serial cable.**
- 2) **Remote Connect – via telephone line.**



See *Direct Link and Solution Link RAS Upload/Download programming in Section 5 — Programming Overview* for more information.

## Callback Verify

Setting this option will force the panel to use call back verification for all remote Solution Link RAS sessions. See MENU 5-3-0 — Call back Number for more information.

## Abort RAS On Alarm

If this option is programmed, the remote RAS connection between the panel and the remote upload / download computer will be terminated if panel registers an alarm that needs to be reported.

## Answering Bypass

Answering machine bypass allows you to establish a RAS connection to a panel when there is an answering machine or facsimile machine connected on the same telephone line.

- 1) **Using Solution Link call the panel and let the phone ring no more than 4 times before hanging up.**
- 2) **Wait a minimum of 8 seconds (but no more than 60 seconds) before calling the panel again. This time the panel will answer the incoming call as soon as it registers the first ring and the connection will be established.**

## Answer Only If Armed

Setting this option will prevent the panel from answering an incoming call unless at least one area on the system is armed. If all areas are off the panel will not answer the call. This option would be useful in a busy office when due to the large volume of incoming calls answering machine bypass may not be effective.

## Tone Bypass

It is often difficult to establish a remote connection to a panel if the customer picks up the phone or if a fax or answering machine answers the call before the panel does.

While the ultimate solution to this problem is the use the CLI Intelliconnect method, this requires the customer to enable CLI via their telco provider.

When enabled, the new Tone Bypass option (MENU 5-3-4) tells the panel to listen to every answered call and to look for a specific sequence of DTMF tones.

The tone sequence will be sent by the remote programming

software and when the panel recognises them, it will immediately seize the line away from the answering party and the programming session will commence.

## Allow User Functions

Setting this option allows access to user functions via the RAS upload/download software. If this option is not programmed, user functions will be disabled.

## Report RAS Sessions

Setting this option will cause the panel to report the start and end of RAS programming sessions to the base station and the history log.

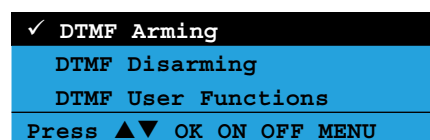
Comms > Remote Access >

### DTMF Options

**I** MENU 5-3-5

1	DTMF Arming	Y
2	DTMF Disarming	N
3	DTMF User Functions	N
4	DTMF Quick Arming	Y
5	Reserved	N
6	Reserved	N
7	Reserved	N
8	Reserved	N

- 1) **Press [MENU] + [5] + [3] + [5]. The keypad will display the current DTMF options.**



- 2) **Use the up and down arrow keys to highlight the option then press the [ON] key to enable or the [OFF] key to disable.**
- 3) **Repeat Step 2 until all options are programmed as required, then press [OK] to save and exit or press [MENU] to exit without saving.**

## DTMF Arming

Setting this option enables user to remotely arm one or more areas on the panel using their PIN and a touch tone phone.

## DTMF Disarming

Setting this option enables users to remotely disarm one or more areas on the panel using their PIN and a touch tone telephone.

## DTMF User Functions

Setting this option enables access to user DTMF functions using their PIN and a touch tone telephone.

## DTMF Quick Arming

Setting this option allows users and control room operators to remotely arm the system using a touch tone

phone without the need for a PIN.

To arm the system call the number which the panel is connected to and when the panel answer you will here 3 beeps in ascending frequency if the panel is in the disarmed condition. Press [0] + [#] to arm. You will hear 3 beeps in descending order when the panel arms.



*All areas on the system will be armed regardless of there condition when using the DTMF quick arm function. These functions follow both timer groups and access groups.*

Unlike other systems, no additional hardware or modules are required for DTMF control.

- 1) **Once the panel answers the incoming call, if either option 1, 2, 3 or 4 in MENU 5-3-5 is enabled, then the panel will play a short welcome jingle. You now have approximately 5 seconds to enter a valid PIN and log onto the panel.**
- 2) **Enter PIN followed by the [#] key. If the PIN is valid the system will respond with two short beeps. If the PIN is invalid then a single long beep will be heard.**
- 3) **If a valid PIN is not entered in time, the panel will attempt to establish a modem connection as if connecting to the Solution Link software. If this happens you will need to hang up for approximately 60 seconds before trying again.**

Once validated, the following commands can be performed. See the table below. If no keys are pressed for 20 seconds then the panel will play the exit jingle before terminating the session and hanging up. Pressing [#][#] at any time while connected will cause the panel to terminate the session.

DTMF CONTROL FUNCTIONS		
Operation	Command	Tone Response
Quick Arm All Areas	[0] + [#]	High, Medium, Low
Log In OK	[PIN] + [#]	Low, High
Error	Incorrect Entry	Long Beep
Turn Area ON	[1] + [Area N°] + [#] + [1]	Low, High
Turn Area OFF	[1] + [Area N°] + [#] + [2]	High, Low
Turn Output ON	[2] + [Output N°] + [#] + [1]	Low, High
Turn Output OFF	[2] + [Output N°] + [#] + [2]	High, Low
End Session	[#] + [#]	High, Medium, Low

*Table 25: DTMF Remote Control Functions*

## DTMF EXAMPLES

Each example below shows the log on step for clarity. In practise is only necessary to log on once per DTMF control session.

### To turn Area 1 ON enter the following

[2] [5] [8] [0] [#] = Log ON

[1] + [1] + [#] + [1] = Arm Area 1

### To turn Output 10 ON enter the following

[2] [5] [8] [0] [#] = Log ON

[2] + [1] [0] + [#] + [1] = Turn Output 10 ON

### To turn Output 12 OFF enter the following

[2] [5] [8] [0] [#] = Log ON

[2] + [1] [2] + [#] + [2] = Turn Output 12 OFF



*If the DTMF Quick Arm option is enabled then it is possible to remotely arm all areas without logging onto the panel. Simply enter [0] + [#] following the welcome jingle.*

*Make sure that the phone being used to remotely control the panel is set to transmit DTMF tones when keys are pressed during the call. This option is disabled by default on some phones.*

Comms > Remote Access >

## Voice Access Code

**I** MENU 5-3-6

9 #

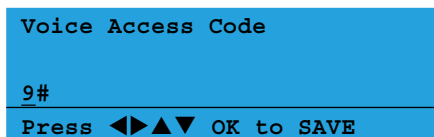
This option sets a 2 digit code which is used to access the panel from any internal phone connected to the same telco line as the panel. For this option to work, a CM101B Voice Module must be connected to the panel.

This default number may need to be changed depending

on the country and or telco exchange / PABX system being used. Make sure that when the code is entered, no external phone services are selected or activated. If they are, then change the code to something else.

It is important to realise that this code is only used to start the connection process. Once a connection is established, the voice module will ask the user to enter their PIN before they will be able to control the panel. The Voice Access Code is shared by all users who need this type of access to the panel. See the CM101B documentation for more details.

- 1) Press [MENU] + [5] + [3] + [6]. The keypad will display the current DTMF options.



- 2) Using the numeric keys enter the new Voice Access Code then press [OK] to save and exit or press [MENU] to exit without saving.

Comms > Remote Access >

CLI Numbers MENU 5-3-7

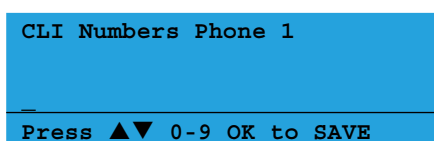
First Number	1	Digits	32
	<input type="text"/>	<input type="text"/>	<input type="text"/>
Second Number	1	Digits	32
	<input type="text"/>	<input type="text"/>	<input type="text"/>
Third Number	1	Digits	32
	<input type="text"/>	<input type="text"/>	<input type="text"/>

CLI Numbers (Call Line Identification) allows the control panel to answer an incoming call only when the control panel identifies that the incoming call is from any one of the three CLI numbers programmed. Up to three different CLI telephone numbers can be programmed, each having a maximum of 32 digits.

- 1) Enter [MENU] + [5] + [3] + [7]. The keypad will display the following:



- 2) Highlight the telephone number that you want to program for CLI number, then press [OK] to select.



- 3) Using the numeric keys, enter the telephone number that you wish to program.

- 4) Press [OK] to save and return to the MENU.



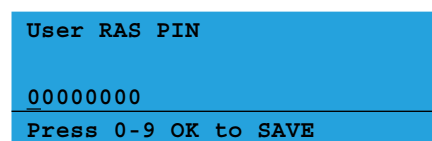
*Up to 3 Phone numbers can be entered for CLI Call Line Identification for remote access detection. You must enter STD code plus the complete number for this option to work. Press [OK] after each telephone number is entered to save and move to the next number.*

Comms > Remote Access >

User RAS PIN	MENU 5-3-8
<input type="text"/> <input type="text"/> <input type="text"/> <input type="text"/> <input type="text"/> <input type="text"/> <input type="text"/> <input type="text"/> <input type="text"/> <input type="text"/>	

Use keys 0 - 9 to program user RAS PIN + [OK] to save.

- 1) Press [MENU] + [5] + [3] + [8]. The keypad will display the current Transmission Format for Destination 2.



- 2) Use the numeric keys to program the user RAS PIN required, then press [OK] to save and exit, or press [MENU] to exit without saving.

## REPORTING OPTIONS

Comms > Reporting >

### TX Format Dest 1

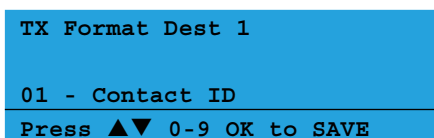
**I** MENU 5-4-0

00 - Disabled	0 1	
01 - Contact ID	07 - Domestic	
02 - SIA	08 - Voice	13 - Ethernet
03 - Reserved	09 - SIA +	14 - GPRS
04 - Reserved	10 - GSM SIA +	15 - Reserved
05 - Reserved	11 - GSM Contact ID	
06 - SMS	12 - GSM SMS	

This menu allows you to program the transmission format or language the panel will use to send event reports to Destination 1. The panel has two separate destinations that reports can be sent to and each one can be set to use a different transmission format depending on the application.

At factory default, all reports are routed to Destination 1.

- 1) Press [MENU] + [5] + [4] + [0]. The keypad will display the current Transmission Format for Destination 1.



- 2) Use the up and down arrow keys to select the Transmission Format required then Press [OK] to save and exit or press [MENU] to exit without saving.

Comms > Reporting >

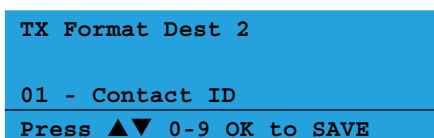
### TX Format Dest 2

**I** MENU 5-4-1

00 - Disabled	0 1	
01 - Contact ID	07 - Domestic	
02 - SIA	08 - Voice	13 - Ethernet
03 - Reserved	09 - SIA +	14 - GPRS
04 - Reserved	10 - GSM SIA +	15 - Reserved
05 - Reserved	11 - GSM Contact ID	
06 - SMS	12 - GSM SMS	

This menu allows you to program the transmission format or language the panel will use to send event reports to Destination 2.

- 1) Press [MENU] + [5] + [4] + [1]. The keypad will display the current Transmission Format for Destination 2.



- 2) Use the up and down arrow keys to select the Transmission Format required then Press [OK] to save and exit or press [MENU] to exit without saving.

Comms > Reporting >

### Test Route

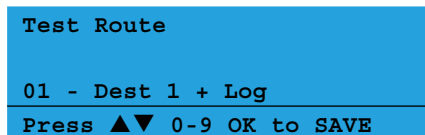
**I** MENU 5-4-2

00 - Log Events Only	0 1	
01 - Dest 1 + Log		
02 - Dest 2 + Log		
03 - Dest 1 & 2 + Log		
04 - Dest 2 If 1 Fails		

(\*\*\* System Wide Parameter \*\*\*)

This menu programs which destination will be used to send both manual and automatic test reports.

- 1) Press [MENU] + [5] + [4] + [2]. The keypad will display the current Test Route.



- 2) Use the up and down arrow keys to select the Test Route required then Press [OK] to save and exit or press [MENU] to exit without saving.

Comms > Reporting >

### System Route

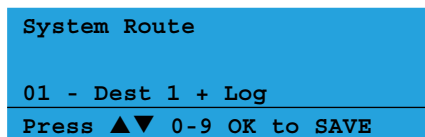
**I** MENU 5-4-3

00 - Log Events Only	0 1	
01 - Dest 1 + Log		
02 - Dest 2 + Log		
03 - Dest 1 & 2 + Log		
04 - Dest 2 If 1 Fails		

(\*\*\* System Wide Parameter \*\*\*)

This menu sets the report destination that will be used to send all system event reports.

- 1) Press [MENU] + [5] + [4] + [3]. The keypad will display the current Status Report route.



- 2) Use the up and down arrow keys to select the Test Route required then Press [OK] to save and exit or press [MENU] to exit without saving.



Comms &gt; Reporting &gt;

**Emergency Route****I** MENU 5-4-4

- 00 - Log Events Only
- 01 - Dest 1 + Log
- 02 - Dest 2 + Log
- 03 - Dest 1 & 2 + Log
- 04 - Dest 2 If 1 Fails

0 1

(\*\*\*) System Wide Parameter (\*\*\*)

This menu programs the destination that all Keypad emergency alarms are reported.

- 1) Press [MENU] + [5] + [4] + [4]. The keypad will display the current Emergency Route.

```
Emergency Route
-----
01 - Dest 1 + Log
Press ▲▼ 0-9 OK to SAVE
```

- 2) Use the up and down arrow keys to select the Keypad Emergency route required then Press [OK] to save and exit or press [MENU] to exit without saving.

Comms &gt; Reporting &gt;

**Swinger Dialler****I** MENU 5-4-5

(\*\*\*) System Wide Parameter (\*\*\*)

0 6

Swinger Dialler can be used to prevent a faulty or run-a-way PIR from continually re-triggering the zone and reporting to the base station.

The Swinger Dialler count sets the maximum number of times an individual zone can trigger an alarm during the current arming cycle before it is locked out.

If this option is not programmed, the panel will continue to report the alarm signal until the system or area is disarmed.

Only zones that have been programmed for Lockout Dialler in MENU 3-1-7 — Report Options will follow the Swinger Dialler count.

- 1) Press [MENU] + [5] + [4] + [5]. The keypad will display the current Swinger Dialler count.

```
Swinger Dialler
-----
6
Press 0-9 OK to SAVE
```

- 2) Using the numeric keys, enter the new Swinger Dialler count then press [OK] to save and exit or press [MENU] to exit without saving. Valid entries are 0 - 15 / 0 = disabled.

Comms &gt; Reporting &gt;

**Burg Report Delay****I** MENU 5-4-6

(\*\*\*) System Wide Parameter (\*\*\*)

0 0 0

Seconds

This menu programs how long the panel will delay reporting Burglary alarm reports. Only burglary (non-fire) zones that have been programmed for Delay Report in MENU 3-1-7 — Report Option will follow the Burglary Report Delay time.

- 1) Press [MENU] + [5] + [4] + [6]. The keypad will display the current burglary report delay time.

```
Burg Report Delay
-----
000 Seconds
Press 0-9 OK to SAVE
```

- 2) Using the numeric keys, enter the new report delay time then press [OK] to save and exit or press [MENU] to exit without saving. Valid entries are 0 to 255 seconds

Comms &gt; Reporting &gt;

**Fire Report Delay****I** MENU 5-4-7

(\*\*\*) System Wide Parameter (\*\*\*)

0 0 0

Seconds

This menu programs how long the panel will delay reporting fire zone alarm reports. Only fire zones that have been programmed for Delay Report in MENU 3-1-7 — Report Option will follow the Fire Report Delay time.

- 1) Press [MENU] + [5] + [4] + [7]. The keypad will display the current Fire Report Delay time.

```
Fire Report Delay
-----
000 Seconds
Press 0-9 OK to SAVE
```

- 2) Using the numeric keys, enter the new report delay time then press [OK] to save and exit or press [MENU] to exit without saving. Valid entries are 0 to 255 seconds.


## MYALARM

Comms > MyAlarm >

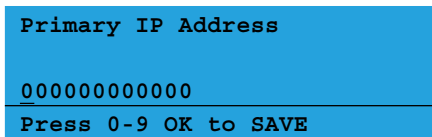
**IP Address** I MENU 5-5-0

1	Digits	12
0 0 0	0 0 0	0 0 0

This menu programs the 12 digit MyAlarm IP Address.

 *MENU 5-5-0 should be left at the factory default settings unless you are advised otherwise by the manufacturer.*

- 1) Press [MENU] + [5] + [5] + [0]. Use the arrow keys to select the IP address to program, then press the [OK] key. The keypad will display the current IP address.




- 2) Using the numeric keys, enter the IP address required, then press [OK] to save and exit, or press [MENU] to exit without saving.

Comms > MyAlarm >

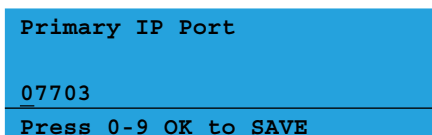
**IP Port** I MENU 5-5-1

0	7	7	0	3
---	---	---	---	---

This menu programs the 5 digit MyAlarm Port number. Range must be programmed within 0 to 65535.

 *MENU 5-5-1 should be left at the factory default settings unless you are advised otherwise by the manufacturer.*

- 1) Enter [5] + [5] + [1] + [OK]. Use the arrow keys to select the IP port to program, then press the [OK] key. The keypad will display the current MyAlarm Port number.



- 2) Using the numeric keys, enter the IP address required, then press [OK] to save and exit, or press [MENU] to exit without saving.

Comms > MyAlarm >

**MyAlarm Options** I MENU 5-5-2

1	Reserved	N
2	Reserved	N
3	Reserved	N
4	Reserved	N
5	Reserved	N
6	Reserved	N
7	Reserved	N
8	Reserved	N

This location is a Bit option field.

Comms > MyAlarm >

**Gateway Numbers** I MENU 5-5-7

SMS Primary

1	Digits	32									
1	8	3	2	1	3	4	5	0	6	4	1

SMS Secondary

1	Digits	32									
1	8	3	2	1	3	4	5	1	8	2	5

Email

1	Digits	32									
1	8	3	2	1	3	4	5	2	5	0	5

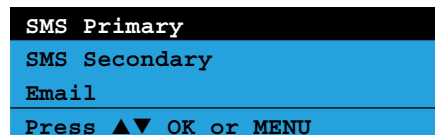
MyAlarm

1	Digits	32									
1	8	3	2	1	3	4	5	2	5	0	5

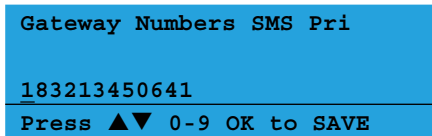
This menu allows the installer to program the gateway telephone numbers for both SMS and email reporting. The MyAlarm gateway telephone number is currently not used.

When SMS reporting, the control panel will call the SMS primary number first. If the control panel fails to report via the SMS primary number, the control panel will then use the SMS secondary number until all current event reports are sent. The next time the control panel needs to report, the control panel will revert back to the SMS primary number.

- 1) Enter [MENU] + [5] + [5] + [7].



- 2) Highlight the gateway telephone number to change and press [OK]. The keypad will display the current gateway telephone number.



- 3) Using the numeric keys, enter all the digits of the gateway telephone number. You can change a single digit by scrolling the cursor left or right. For special characters including, pause, \* or #, use the up and down arrow keys.
- 4) Press [OK] to save and exit or press [MENU] to exit without saving.

Comms &gt; MyAlarm &gt;

Email Address



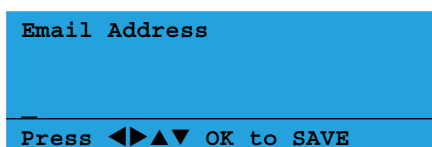
MENU 5-5-8

Email Address 1 Characters 80

This menu allows the master user to program an email address that the system will send email reports to. A maximum of 80 characters can be used to program the email address.

- 1) Enter your Master PIN + [MENU].
- 2) Enter [5] + [5] + [8] + [OK].

The keypad will display the current email address.



- 3) Use the numeric, [0] to [9], [←] and [→] keys to enter or change the email address as required.

At any time you can use the [↑] and [↓] keys to scroll through the complete list of available characters.

To clear all characters from the cursor position to the right, press the [OFF] key.

- 4) When the email address is complete, press [OK] to save and exit, or press [MENU] to exit without saving.

To stop email reporting simply remove the email address or disable all of the email options in MENU 5-5-9.



When entering an email address the @ symbol is represented on the keypad display as . To enter this character press the 1 key repeatedly until the symbol appears in the display.

Comms &gt; MyAlarm &gt;

Email Options



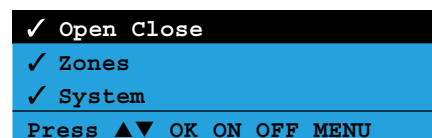
MENU 5-5-9

1	Open Close	Y
2	Zones	Y
3	System	Y
4	Access	Y
5	Reserved	N
6	Reserved	N
7	Reserved	N
8	Reserved	N

This menu allows the master user to select which event types will be reported using the email reporting function. By default the first 4 options are set to report via email. Follow the procedure below to configure the required options.

- 1) Enter your Master PIN + [MENU].
- 2) Enter [5] + [5] + [9] + [OK].

The keypad will display the list of current options. Options with a preceding tick mark are selected.



- 3) Use the [↑] and [↓] keys to highlight the feature that you want to program, then use the [ON] and [OFF] keys to turn on and off the features as required.
- 4) When all email options are programmed, press [OK] to save and exit, or press [MENU] to exit without saving.

#### Open Close

This option allows the control panel to report 'open' and 'close' reports via email.

#### Zones

This option allows the control panel to report zone 'alarm' and 'trouble' reports via email.

#### System

This option allows the control panel to report via email numerous system reports (e.g. AC Fail, Low Battery etc) via email.

#### Access

This option allows the control panel to report via email when a valid token has been swiped eg. 'Access Granted' or 'Access Denied'.

Comms &gt; IP Reporting &gt;

## Receiver IP

MENU 5-6-0

	1		Digits		12							
Dest N° 1	0	0	0	0	0	0	0	0	0	0	0	0
Dest N° 2	0	0	0	0	0	0	0	0	0	0	0	0

This menu allows the installer to program the TCP IP address for Destination 1 and/or Destination 2 so that the control panel can communicate to the base station receiver.

- 1) Press [MENU] + [5] + [6] + [0]. The keypad will prompt you to select which destination (destination 1 or 2) that you want to program the base station IP address.

```

Rr1 Dest 1
Rr2 Dest 2
Exit
Press ▲▼ OK or MENU

```

- 2) Highlight the destination number (1 or 2) required, then press [OK] to select.
- 3) The keypad will display the first six digits of the base station IP address.

```

Receiver IP Rr1
000000000000
Press 0-9 OK to SAVE

```

- 4) Use the numeric keys [0] to [9] + [←] and [→] keys to program the new MyAlarm IP Address, then press [OK] to save and exit or press [MENU] to exit without saving.

Comms &gt; IP Reporting &gt;

## Receiver Port

MENU 5-6-1

Dest N° 1	0	7	7	0	0
Dest N° 2	0	7	7	0	0

This menu allows the installer to program the TCP IP port number for Destination 1 and/or Destination 2 so that the control panel can communicate to the base station receiver. The port number must be 5 digits long within the range - to 65535.

- 1) Press [MENU] + [5] + [6] + [1]. The keypad will prompt you to enter which destination (destination 1 or 2) that you want to program the base station port number.

```

Rr1 Dest 1
Rr2 Dest 2
Exit
Press ▲▼ OK or MENU

```

- 2) Highlight the destination number (1 or 2) required, then press [OK] to select.
- 3) The keypad will display the current base station port number.

```

Receiver Port Rr1
07700
Press 0-9 OK to SAVE

```

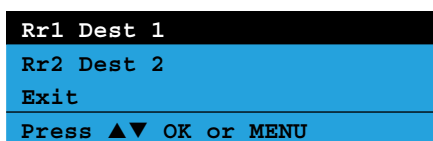
- 4) Use the numeric keys [0] to [9] to program the new MyAlarm IP Address, then press [OK] to save and exit or press [MENU] to exit without saving.

Comms &gt; IP Reporting &gt;

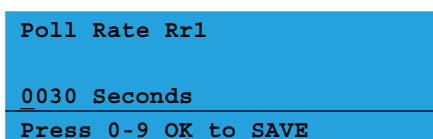
**Poll Rate**

This menu allows the installer to program how often the control panel sends a signal to the base station receiver via Destination 1 and/or Destination 2. The poll interval programmed in seconds and then multiplied by 10 (eg. 0009 = 90 sec's / 0360 = 1 hr / 4320 = 12 hrs and 8640 = 24 hrs). This should be set so that the control panel sends a poll to the base station receiver at least once within the polling time required.

- 1) Press [MENU] + [5] + [6] + [2]. The keypad will prompt you to select which destination (destination 1 or 2) that you want to program the poll rate.



- 2) Highlight the destination number (1 or 2) required, then press [OK] to select.
- 3) The keypad will display the current poll rate.



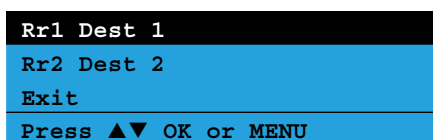
- 4) Use the numeric keys [0] to [9] to program the new poll rate in seconds (0000 to 9999 seconds x 10), then press [OK] to save and exit or press [MENU] to exit without saving.

Comms &gt; IP Reporting &gt;

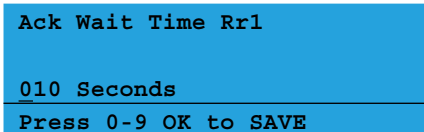
**ACK Wait Time**

This menu allows the installer to program the acknowledge wait time in seconds for both Destination 1 and/or Destination 2. The acknowledge wait time can be programmed between 1 and 255 seconds (0 = Disabled).

- 1) Press [MENU] + [5] + [6] + [3]. The keypad will prompt you to select which destination (destination 1 or 2) that you want to program the acknowledge wait time.



- 2) Highlight the destination number (1 or 2) required, then press [OK] to select.
- 3) The keypad will display the current acknowledge wait time.



- 4) Use the numeric keys [0] to [9] to program the new acknowledge wait time in seconds (000 to 255), then press [OK] to save and exit or press [MENU] to exit without saving.

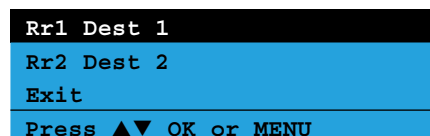
Comms &gt; IP Reporting &gt;

**IP Format**

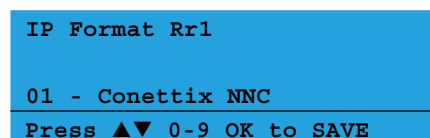
- 00 - Conettix
- 01 - Conettix NNC (Anti Replay)
- 02 - CSV IP ALARM
- 03 - Suretek (TBA)
- 04 - Permacom (TBA)
- 05 - Direct Wireless (TBA)
- 06 - MyAlarm CID (TBA)

This menu allows the installer to program which IP format the control panel will report to the base station receiver.

- 1) Press [MENU] + [5] + [6] + [4]. The keypad will prompt you to select which destination (destination 1 or 2) that you want to program the acknowledge wait time.



- 2) Highlight the destination number (1 or 2) required, then press [OK] to select.
- 3) The keypad will display the current IP format.



- 4) Use the numeric keys [0] to [9] to program the new IP format required, then press [OK] to save and exit or press [MENU] to exit without saving.

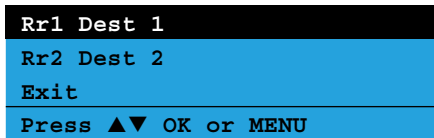
Comms > IP Reporting >

### Retry Count



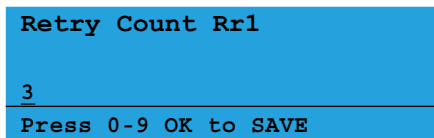
This menu allows the installer to program the number of attempts that the system will try to communicate via TCP/IP to the base station receiver for both Destination 1 and/or Destination 2. The retry count can be programmed between 01 and 15 (00=Disabled).

- 1) Press [MENU] + [5] + [6] + [5]. The keypad will prompt you to select which destination (destination 1 or 2) that you want to program the acknowledge wait time.



- 2) Highlight the destination number (1 or 2) required, then press [OK] to select.

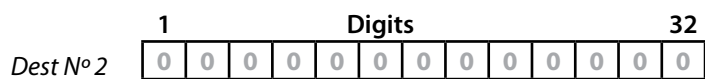
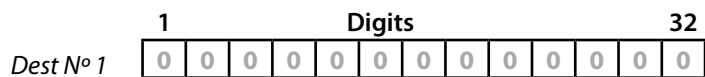
The keypad will display the current retry count.



- 3) Use the numeric keys [0] to [9] to program the new retry count, then press [OK] to save and exit or press [MENU] to exit without saving.

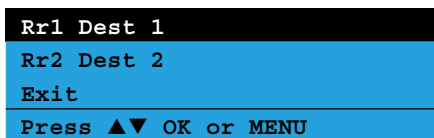
Comms > IP Reporting >

### Encryption Key



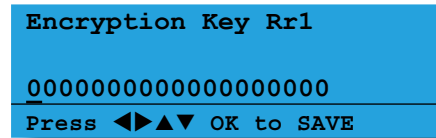
The encryption key must match the encryption key on the base station receiver for communication to take place. To remove encryption, set MENU 6-6-4 as all zero's.

- 1) Press [MENU] + [5] + [6] + [6]. The keypad will prompt you to select which destination (destination 1 or 2) that you want to program the acknowledge wait time.



- 2) Highlight the destination number (1 or 2) required, then press [OK] to select.

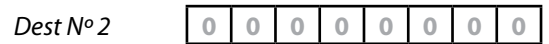
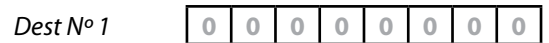
The keypad will display the current encryption key.



- 3) Use the numeric keys [0] to [9] + [←] and [→] keys to program the 32 digit encryption key, then press [OK] to save and exit or press [MENU] to exit without saving.

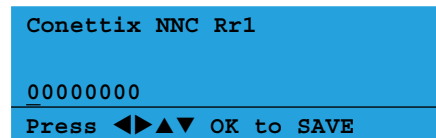
Comms > IP Reporting >

### Conettix NNC



The NCC number is used to prevent anti-replay attacks when reporting in Connetix format. The NNC number will be assigned by the control room at the time the account is setup. Like the account number, the NNC will always be unique.

- 1) Press [MENU] + [5] + [6] + [7]. The keypad will display the first 6 digits of the current NNC number.



- 2) Use the numeric keys [0] to [9] + [←] and [→] keys to program the 8 digit NNC number, then press [OK] to save and exit or press [MENU] to exit without saving.

Comms &gt; IP Reporting &gt;

**SIA IP Prefix****I MENU 5-6-8**

Account	1	Digits								16	
Dest N° 1	0	0	0	0	0	0	0	0	0	0	0

Account	1	Digits								16	
Dest N° 2	0	0	0	0	0	0	0	0	0	0	0

Account Prefix	1	Digits				6
Dest N° 1	0	0	0	0	0	0

Account Prefix	1	Digits				6
Dest N° 2	0	0	0	0	0	0

Receiver Prefix	1	Digits				6
Dest N° 1	0	0	0	0	0	0

Receiver Prefix	1	Digits				6
Dest N° 2	0	0	0	0	0	0

**Account Number**

The account number is the most specific token and is always programmed into the premises equipment to identify it. The account token appears both in the header of the message (which is never encrypted) and in the data of the message (which may be encrypted).

This element consists of an ASCII "#", followed by 3 to 16 ASCII characters representing hexadecimal digits for the account number. There is no corresponding element in the DC-07 protocol.

In certain special applications, the information provided in the #acct element may not match the account number contained within the message data. For example, a manufacturer may choose to transmit a MAC address as an identifier.

**Account Prefix**

The account prefix can be programmed into the PE to extend the identification provided by the account number.

This element is required and consists of an ASCII "L", followed by 1-6 HEX ASCII digits for the account prefix. When the PE does not need to transmit an account prefix, "L0" shall be transmitted for this element. This element corresponds with the receiver line number element in the DC-07 protocol.

**Receiver Prefix**

In some cases, the PE may be programmed to further extend the identification provided by the account number and account prefix by providing a receiver number. This element is optional and consists of an ASCII "R", followed by 1-6 HEX ASCII digits for the receiver number. When the PE does not need to transmit a receiver number, nothing shall be transmitted for this element (ie. "R" or "R0" are not to be transmitted in this case).

- 1) Press [MENU] + [5] + [6] + [8]. The keypad will prompt you to select which option that you want to program.

```
SIA IP Account
SIA IP Account Prefix
SIA IP Receiver Prefix
Press ▲▼ OK or MENU
```

- 2) Highlight the option required, then press [OK] to select.

```
Rr1 Dest 1
Rr2 Dest 2
Exit
Press ▲▼ OK or MENU
```

- 3) Highlight the destination that you want to program, then press [OK] to select.

```
SIA IP Account Rr1
Press ◀▶▲▼ OK to SAVE
```

- 4) Use the numeric keys [0] to [9] to program the parameter, then press [OK] to save and exit or press [MENU] to exit without saving.

Comms &gt; IP Reporting &gt;

**User Name/Password****I MENU 5-6-9**

Username	1	Digits								16	

Password	1	Digits								16	

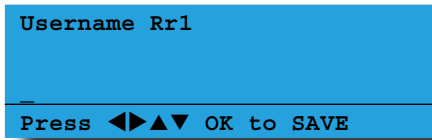
- 1) Press [MENU] + [5] + [6] + [9]. The keypad will prompt you to select which option to program (username or password) that you want to program.

```
Username
Password
Exit
Press ▲▼ OK or MENU
```

- 2) Highlight the option required, then press [OK] to select.

```
Rt1 Dest 1
Rt2 Dest 2
Exit
Press ▲▼ OK or MENU
```

- 3) Highlight the destination that you want to program, then press [OK] to select.



- Use the [0] to [9] and [↑] and [↓] keys to program the parameter, then press [OK] to save and exit or press [MENU] to exit without saving.

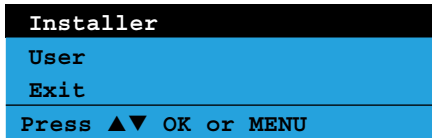
Comms > IP Remote Access >

**IP Address** I-M MENU 5-7-0



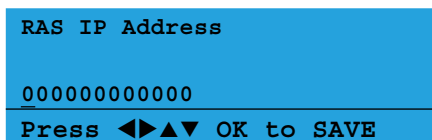
This menu allows the installer or master user the ability to program the Solution Link IP address.

- Press [MENU] + [5] + [7] + [0]. The keypad will prompt you to enter which Solution Link IP address (IP 1 = Installer or IP 2 = User) that you want to program.



The installer can now select either the installer Solution Link IP address or the user Solution Link IP address by using the up and down arrow keys. If the Master user programs this menu, the keypad will only display the option to program the user IP address:

- Select the which IP address that you want to change (installer or user, then press [OK] to enter.
- The keypad will display the first six digits of the Solution Link IP address.

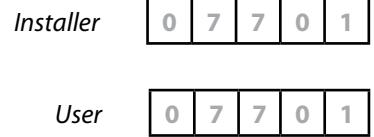


- Use the numeric keys [0] to [9] + [←] and [→] keys to program the IP Address, then press [OK] to save and exit or press [MENU] to exit without saving.

Comms > IP Remote Access >

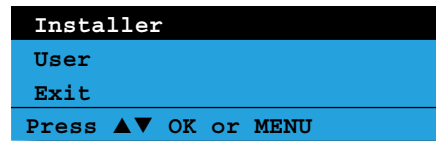
**IP Port**

I-M MENU 5-7-1



This menu allows the installer or master user the ability to program the Solution Link IP port number. The Solution Link IP port number must be 5 digits in length and programmed within the range of 0 to 65535.

- Press [MENU] + [5] + [7] + [1]. The keypad will prompt you to enter which Solution Link IP port number (IP 1 = Installer or IP 2 = User) that you want to program..



The installer can now select either the installer Solution Link IP port number or the user Solution Link IP port number by using the up and down arrow keys. If the Master user programs this menu, the keypad will only display the option to program the user IP port number:

- Select the which IP port number that you want to change (installer or user, then press [OK] to enter.
- The keypad will display the first six digits of the Solution Link IP port number.



- Use the numeric keys [0] to [9] + [←] and [→] keys to program the IP Address, then press [OK] to save and exit or press [MENU] to exit without saving.



Comms &gt; IP Remote Access &gt;

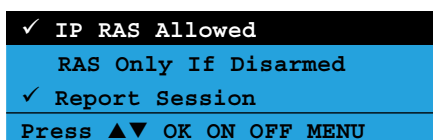
**IP RAS Options****I** MENU 5-7-2

1	IP RAS Allowed	Y
2	IP RAS Only If Disarmed	N
3	Report IP Session	Y
4	Report IP Lockout	Y
5	UDP Installer RAS	Y
6	UDP User RAS	N
7	Reserved	N
8	Reserved	N

This menu allows the installer to select which IP options are allowed.

- 1) Press [MENU] + [5] + [7] + [2].

The keypad will display the current options which are selected or enabled.



- 2) Use the numeric keys [1] to [8] to turn on and off the features as required. When the corresponding number on the keypad is on then the option is selected.
- 3) When all email options are programmed, press [OK] to save and exit, or press [MENU] to exit without saving.

**IP RAS Allowed**

This option allows the control panel to connect with Solution Link via the optional ethernet module.

**IP RAS Only If Disarmed**

This option allows a RAS connection via TCP IP connection only when the system is disarmed.

**Report IP Session**

This option allows the control panel to report a RAS Start and RAS End session to the security base station when a remote TCP IP connection was made and ended.

**Report IP Lockout**

This option allows the control panel to report when the maximum number of incorrect attempts has been made to remotely connect to the panel using the IP connection method.

**UDP Installer RAS**

This option allows the control panel to communicate using the UDP internet protocol (User Datagram Protocol) when the installer remotely connects via Solution Link software.

If this option is not programmed, the control panel will use the TCP IP protocol.

**UDP User RAS**

This option allows the control panel to communicate using the UDP internet protocol (User Datagram Protocol) when the user remotely connects via Solution Link software.

If this option is not programmed, the control panel will use the TCP IP protocol.

Comms &gt; IP Remote Access &gt;

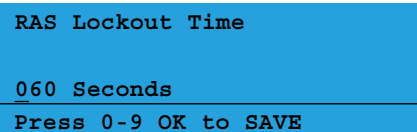
**RAS Lockout Time****I** MENU 5-7-3

0 6 0

Seconds

This menu allows the control panel to lockout and prevent the ability for anyone to remotely connect to the system using the RAS IP connection method. During the lockout time, (1 to 255 seconds / 0 = No Lockout), the system will not respond to any TCP IP connection requests. The lockout count is set at 6 failed attempts (fixed) over a 60 second period)

- 1) Press [MENU] + [5] + [7] + [3]. The keypad will display the current IP RAS Lockout time.



- 2) Using the numeric keys, enter the new IP RAS Lockout Time, then press [OK] to save and exit or press [MENU] to exit without saving. Valid entries are 0 to 255 seconds

Comms &gt; IP Remote Access &gt;

## IPRS Address

I MENU 5-7-5

1	Digits								12		
2	0	2	1	2	9	0	8	3	0	5	8

This menu is reserved for factory use. Do not change unless requested to do so.

- 1) Press [MENU] + [5] + [7] + [5]. The keypad will display the current IPRS address.

```

DNS Address
-----
202129083058
Press ◀▶▲▼ OK to SAVE
  
```

- 2) Use the numeric keys [0] to [9] + [←] and [→] keys to program the 12 digit IPRS address, then press [OK] to save and exit or press [MENU] to exit without saving.

Comms &gt; IP Remote Access &gt;

## IPRS Port

I MENU 5-7-6

0	7	7	0	3
---	---	---	---	---

This menu is reserved for factory use. Do not change unless requested to do so. This menu must be 5 digits set with the range of 0 to 65535.

- 1) Press [MENU] + [5] + [7] + [6]. The keypad will display the current IPRS port.

```

IPRS Port
-----
07703
Press ◀▶▲▼ OK to SAVE
  
```

- 2) Use the numeric keys [0] to [9] + [←] and [→] keys to program the 32 digit encryption key, then press [OK] to save and exit or press [MENU] to exit without saving.

## COMMS TESTING

Comms &gt; Comms Test &gt;

## Send Test Report

I-M-U MENU 5-9-0

This menu allows you to test the reporting functions of the control panel by manually sending a Test report to the receiving party (i.e. security company monitoring station, mobile telephone etc).

- 1) Enter [MENU] + [5] + [9] + [0]. The keypad will prompt that it is in the process of sending a test report.

```

Comms Testing In
Progress ..Please Wait..
-----
Press OK or MENU
  
```

- 2) If the test is successful, the keypad will prompt:

```

Comms Test Successful
-----
Press OK or MENU
  
```

- 3) If the test fails, the keypad will prompt:

```

Test Report Failed..
Please Call For Service
-----
Press OK or MENU
  
```

- 4) Press [OK] or [MENU] to exit.

Comms &gt; Comms Test &gt;

## Test Report Time

I MENU 5-9-1

Test Time			
0	2	:	00
H	H	:	M M

This menu programs the time of the day that the panel will send the automatic Test Report to the base station receiver. Automatic test reports are used to verify the panels ability to report events via the telephone line on an ongoing basis.

- 1) Press [MENU] + [5] + [9] + [1]. The keypad will display the current Test Report Time.

```

Test Report Time
-----
02:00am
Press ◀▶▲▼ OK to SAVE
  
```

- 2) Use the left, right, up and down arrow keys to select the Test Report time required then Press [OK] to save and exit or press [MENU] to exit without saving.



Scroll through the hours using the up and down arrow keys to change the time from am to pm.

Comms > Comms Test >

### Test Report Period

**I** MENU 5-9-2

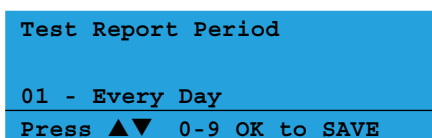
(\*\*\* System Wide Parameter \*\*\*)

0 1

00 - No Test Report	08 - Reserved
01 - Every Day	09 - Reserved
02 - Every Week	10 - Reserved
03 - Every Month	11 - Reserved
04 - Every 2 Days	12 - Reserved
05 - Every 3 Days	13 - Reserved
06 - Every 4 Days	14 - Every Hour
07 - Every 5 Days	15 - Every 12 Hours

This menu programs how often the control panel will send a test report. Only one option can be programmed.

- 1) Press [MENU] + [5] + [9] + [2]. The keypad will display the current Test Report Period.



- 2) Use the up and down arrow keys to select the Test Report Period then Press [OK] to save and exit or press [MENU] to exit without saving.

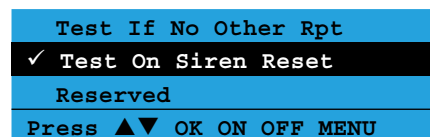
Comms > Comms Test >

### Test Report Options

**I** MENU 5-9-3

1	Test If No Other Rpt	N
2	Test On Siren Reset	Y
3	Reserved	N
4	Reserved	N
5	Reserved	N
6	Reserved	N
7	Reserved	N
8	Reserved	N

- 1) Press [MENU] + [5] + [9] + [3]. The keypad will display the current Test Report Options.



- 2) Use the up and down arrow keys to highlight the option then press the [ON] key to enable or the [OFF] key to disable.
- 3) Repeat Step 2 until all options are programmed as required, then press [OK] to save and exit or press [MENU] to exit without saving.

#### Test If No Other Rpt

Setting this option will cause the system to only send its automatic Test report if no other area report has been sent within the test report time period as programmed in MENU 5-9-2.

#### Test On Siren Reset

Setting this option will delay the Automatic Test Report if the sirens are running when the test report time expires. This effectively keeps the telco line free to make any further alarm reports which may be triggered while the sirens are running. The panel will send the cued Test Report as soon as the siren run-time has expired.

Comms &gt; Comms Test &gt;

**Test Route****I** MENU 5-9-4

0 1



The panel will make only one attempt to call this number per activation. To perform multiple tests repeat the sequence. There is no need to answer the test call.

» » E N D O F S E C T I O N « «

- 00 - Log Events Only
- 01 - Dest 1 + Log
- 02 - Dest 2 + Log
- 03 - Dest 1 & 2 + Log
- 04 - Dest 2 If 1 Fails

This menu programs which destination will be used to send both manual and automatic test reports.

(\*\*\* System Wide Parameter \*\*\*)

- 1) Press [MENU] + [5] + [9] + [4]. The keypad will display the current Test Route.

```
Test Route
-----
01 - Dest 1 + Log
Press ▲▼ 0-9 OK to SAVE
```

- 2) Use the up and down arrow keys to select the Test Route required then Press [OK] to save and exit or press [MENU] to exit without saving.

Comms &gt; Comms Test &gt;

**Dial Number Test****I** MENU 5-9-5

This option provides a quick and easy way for the Installer to test the communication path for the panel while they are onsite without the need to trigger test reports and then verify them with the base station. Once the telco wiring has been completed, enter your mobile phone or another test number into this location and press [OK]. The panel will then seize the phone line and dial the programmed number.

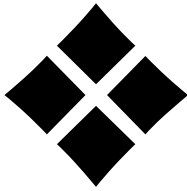
- 1) Press [MENU] + [5] + [9] + [5], then select either PSTN or GMS communication to test the dialler if an optional GSM module has been fitted.

```
GSM
PSTN
Exit
-----
Press ▲▼ OK or MENU
```

- 2) Use the numeric keys to enter the the test number. You can change a single digit in the number by scrolling the cursor left or right. For special characters (eg, , = pause \* or # etc), use the up and down arrow keys. To clear all text from the cursor position to the right, press the [OFF] key.

```
Enter Digits To Dial
-----
Press ◀▶▲▼ OK to SAVE
```

- 3) Press [OK] when finished to start the test.



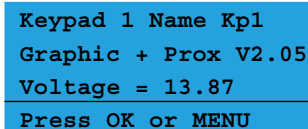
# Device Programming

This chapter covers the different device types and the numerous programmable options which can be used to control how a device operates.

The commands menu allows you to view the status of any device in the system and will display its condition as well as the temperature and voltage where available.

Keypads are the most common device used in the system and must be assigned to a home area if they are to operate correctly in a system. You are also able to set the contrast, backlight and beeper volume to your own personal preference.

RF Devices can also be connected to the system and from this menu you are able to set supervision times, receiver jamming, tamper options and more.



```
Keypad 1 Name Kp1
Graphic + Prox V2.05
Voltage = 13.87
Press OK or MENU
```

- 3) Press [OK] or [MENU] to exit when finished.

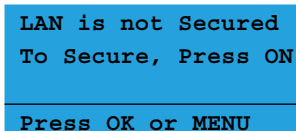
Devices > Commands >

LAN Secure

**I** MENU 6-0-1

If the LAN network is secure, this will prevent the system detecting additional LAN devices when the system has been powered down, additional devices connected and powered back up again. If the LAN network is not secured, the system will automatically detect any additional devices added when the system has been powered down and then powered back up again.

- 1) Press [MENU] + [6] + [0] + [1]. If the system LAN is not secured, the keypad will display the following.



```
LAN is not Secured
To Secure, Press ON
Press OK or MENU
```

- 2) Use the ON and OFF keys to toggle LAN secure on or off.
- 3) Press [OK] to exit.

## DEVICE COMMANDS

Devices > Commands >

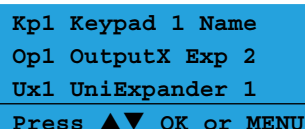
Device Status

**I** - **M** - **U** MENU 6-0-0

This command will allow you to view the status of any device connected to the system (except CM195 Multi RF Receiver Module). The following information is available:

- ❖ Line 1 = LAN Device and Number
- ❖ Line 2 = Firmware Version
- ❖ Line 3 = Voltage, Temperature & Area Assignment.

- 1) Press [MENU] + [6] + [0] + [0] and use the up and down arrows to highlight the device in the list and press [OK]. The display will show the device status.



```
Kp1 Keypad 1 Name
Op1 OutputX Exp 2
Ux1 UniExpander 1
Press ▲▼ OK or MENU
```

- 2) The status line will scroll the keypad voltage, temperature and area while the device type and firmware version number are continuously displayed.

Devices &gt; Commands &gt;

**LAN Scan****I** MENU 6-0-2

This menu allows the installer to rescan a non-secured LAN network when adding or removing LAN expansion devices (eg. keypads, input modules, output modules etc), without the need to power down the control panel.

- 1) Press [MENU] + [6] + [0] + [2]. If the system LAN is not secured, the keypad will display the following.

```
LAN scan has been
requested. This will end
your login session
...Please Wait
```

```
Scanning LAN for Devices
Please Wait ... /
Found Output Exp 2
```

Devices &gt; Commands &gt;

**LAN Watch****I** MENU 6-0-3

This menu allows the installer to view the number of retry packets that are being sent out on the bus on a per module basis.

The menu list is structured with the Packet Retry Count followed by Device ID then the Device Name. Simply scroll through the list with the arrow keys to view the devices.

Move the cursor to the device of interest and press the OFF key to reset the Packet Retry Count or press and hold down the OFF key to reset the Packet Retry Count for all devices.

The packet retry count is also reset on power up and continues to count upwards on an ongoing basis and once reaches the maximum of 255 will stop until manually reset.

Under normal circumstances a device should not have a large retry count but over time this is possible.

- 1) Press [MENU] + [6] + [0] + [3] and use the up and down arrows to highlight the device in the list.

```
001 Fp2 Keypad 1 Name
017 Kp1 Keypad 3 Name
010 Kp1 Keypad 5 Name
Press ▲▼ OK or MENU
```

- 2) Press [OK] or [MENU] to exit.

Devices &gt; Commands &gt;

**Keypad Volume****I-M** MENU 6-0-7

This menu allows you to adjust the volume of the keypad's speaker to suit the application or customer preference. Each keypad on the system can be adjusted separately.

- 1) Press [MENU] + [6] + [0] + [7] and use the up and down arrows to highlight the keypad in the list then press [OK].

```
Keypad 001 Volume
L . . . . . H
  ▲
  ───────────
Press ◀▶▲▼ OK to SAVE
```

- 2) Use the arrow keys to set the required volume level. Each time a key is pressed, you will hear a beep indicating the new volume level. When finished press [OK].



To completely silence the keypad speaker, simply move the slider all the way to the left. This will disable the keypad speaker for all functions including key press beeps.

Devices &gt; Commands &gt;

**Keypad Contrast****I-M** MENU 6-0-8

This menu allows you to adjust the contrast of the keypad's LCD display to suit the application or customer preference. Each keypad on the system can be adjusted separately.

- 1) Press [MENU] + [6] + [0] + [8] and use the up and down arrows to highlight the keypad in the list then press [OK].

```
Keypad 001 Contrast
L . . . . . H
  ▲
  ───────────
Press ◀▶▲▼ OK to SAVE
[1] [2] [3] [4] [5] [6] [7] [8]
[9] [0] [F1] [F2] [F3] [F4] [F5] [F6] [F7] [F8]
```

- 2) Use the arrow keys to set the required contrast level. Each time a key is pressed the contrast will adjust to the new level. When finished press [OK].

Devices &gt; Commands &gt;

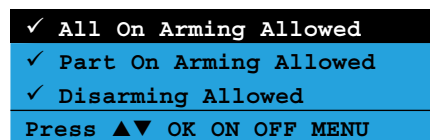
**Keypad Backlight****I-M** MENU 6-0-9

This menu allows you to adjust the brightness of the backlight on the keypad's LCD display. Each keypad can be adjusted separately to suit the customers needs.

- 1) Press [MENU] + [6] + [0] + [9] and use the up and down arrows to highlight the keypad in the list then press [OK].



- 2) Use the arrow keys to set the required backlight level. Each time a key is pressed the backlight will adjust to the new level. When finished press [OK].



- 2) Use the up and down arrow keys to highlight the option then press the [ON] key to enable or the [OFF] key to disable.

- 3) Repeat Step 2 until all options are programmed as required, then press [OK] to save and exit or press [MENU] to exit without saving.

### All On Arming Allowed

Selecting this option allow the user to turn the area All On that the keypad or LAN reader is assigned to when a valid PIN, token or fingerprint is presented. The user must have access to the area that the keypad or LAN reader has been assigned to. See MENU 1-6-1 — Reader Area Assignment.

### Part On Arming Allowed

Selecting this option allows the user to turn the area Part On or Part 2 On that the keypad or LAN reader is assigned to when a valid PIN, token or fingerprint is presented.

### To Turn Area All On Via Token/Fingerprint

From the disarmed state, present the token or fingerprint once to turn the area All On.

### To Turn Area Part On Via Token/Fingerprint

Present the token or fingerprint twice within 5 seconds and the area will turn Part On.

### To Turn Area Part 2 On Via Token/Fingerprint

Present the token or fingerprint three times within 5 seconds and the area will turn Part 2 On.

### Disarming Allowed

Selecting this option allows the user to turn off (disarm) the area that the keypad or LAN reader is assigned to when a valid PIN, token or fingerprint presented. The user must have access to the area that the keypad or LAN reader has been assigned to. See MENU 1-6-1 — Reader Area Assignment.

### Single Button Control

This option allows single key arming (All On or Part On) and single key disarming (from Part On or Part 2 On) when using the keypad. Refer to programming areas for respective options set per area.

### All User Areas

This option allows the user to turn on or off all areas that the user has been assigned to at the same time when they swipe their token or fingerprint. At the keypad, the user would simply enter their PIN and then press and hold the [ON], [PART] or [OFF] keys to turn on or off all areas they belong to.

## KEYPAD & READER OPTIONS

Devices > Keypads & Readers >

Name	I-M	MENU 6-1-0
K e y p a d	1	N a m e

This menu allows you to program the name or location description of the keypad or LAN reader.

- 1) Enter [MENU] + [6] + [1] + [0] and select the keypad or LAN reader from the list and press [OK].



- 2) Use the arrow and number keys to move and change text. When the Reader Name is complete, press [OK]. At any time you can press the [OFF] key to clear the text from the current cursor position to the end of the line.



See Alpha Text Programming in Section 4 - Programming Overview for further detail on entering alpha text.

Devices > Keypads & Readers >

Area Options	I	MENU 6-1-2
--------------	---	------------

1	All On Arming Allowed	Y
2	Part On Arming Allowed	Y
3	Disarming Allowed	Y
4	Single Button Control	Y
5	All User Areas	N
6	Zero Exit Time	N
7	PIN To Change Area	N
8	Home Area Only	N

- 1) Enter [MENU] + [6] + [1] + [2] and select the keypad or LAN reader from the list then press [OK].

## Zero Exit Time

Selecting this option allow the user to turn the area All On or Part On/Part 2 On from the keypad or LAN reader with no exit time.

## PIN To Change Area

Setting this option will prevent a user from switching between different areas on the keypad unless they enter a valid user PIN.

When this option is not set, users will be able to change the keypad view to all other areas in the system regardless of whether or not they have access to those areas.

## Home Area Only

Setting this option will force the keypad to display only it's assigned home area information. Therefore a user cannot toggle (or move) the keypad display to show that of a different area when the system has been partitioned.

Devices > Keypads & Readers >

## Home Area

**I** MENU 6-1-3

0 1

00 - No Area	05 - Area 5 Name
01 - Security System	06 - Area 6 Name
02 - Area 2 Name	07 - Area 7 Name
03 - Area 3 Name	08 - Area 8 Name
04 - Area 4 Name	

This menu allows you to assign each keypad or LAN reader to a default home area (Area 1 to 8). Only 1 home area can be programmed for each keypad or LAN reader.

If a user toggles the keypad display to view a different area, the keypad will automatically timeout and move back to the home area if no key is pressed for a period of 60 seconds.

To prevent users from viewing areas which they do not have access to, you will need to enable the PIN To Change Area option. Setting this option will set the system to request a user's PIN before allowing them to view another area. The system will only allow a user to view the areas they have access to. See MENU 6-1-4 — Keypad General Options.

- 4) Press [MENU] + [6] + [1] + [3] and use the up and down arrows to highlight the keypad in the list then press [OK]. Use the up and down arrow keys to select the Home Area required then press [OK] to save and exit or press [MENU] to exit without saving.

```

Home Area Kp1
01 - Security System
Press ▲▼ 0-9 OK to SAVE
  
```



Note

*Each keypad must be set to a unique address via the DIP switches on the keypad and each keypad must have a home area programmed to operate correctly. Area 1 is the default home area for all keypads.*



Devices > Keypads & Readers >

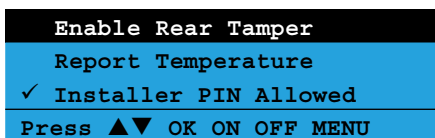
**General Options**

**MENU 6-1-4**

1	Enable Rear Tamper	N
2	Report Temperature	Y
3	Installer PIN Allowed	Y
4	Show Alarm When Armed	N
5	Reader Area Control	Y
6	Reader Badging	N
7	Enable Egress Input	N
8	Log Egress Events	N

The above options can be configured independantly for each keypad fitted to the system.

- 1) Press [MENU] + [6] + [1] + [4] and use the up and down arrows to highlight the keypad in the list then press [OK].



- 2) Use the up and down arrow keys to highlight the option then press the [ON] key to enable or the [OFF] key to disable.
- 3) Repeat Step 2 until all options are programmed as required, then press [OK] to save and exit or press [MENU] to exit without saving.

**Enable Rear Tamper**

This option allows the tamper circuit located on the back of the LAN device to function. As soon as the LAN device has been removed from the wall, the control panel will register an alarm event..

For this option to work, the keypad model being used must have the on-board tamper switch fitted.

**Report Temperature**

This option allows the control panel to report temperature high and low alarm reports when the temperature at the LAN device falls below or increases outside the global temperature settings in MENU 7-7-3.

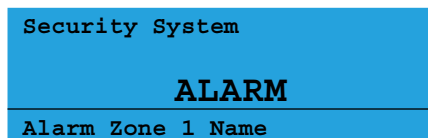
**Installer Allowed**

This option allows the installer to access to the the system menus or to turn the aea (or system) on or off at LAN device.

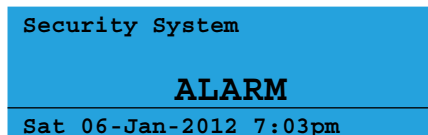
**Show Alarm When Armed**

This option allows the keypad to display which zone registered an alarm. If multiple zones have registered an alarm, the keypad will scroll each zone one at a time.

If the option is programmed, the keypad will display as below:



If the option is not programmed, the keypad will display as below:



**Reader Area Control**

This option allows the user to control the alarm area as well as access at the same time. Turning this option off would make the console a pure access only device.

**Reader Badging**

This option allows the user to unlock a door (via Doors) and also turn on or off an area from the same LAN reader independently.

	No Badging	Badging Required
<b>Area Is All On</b>		
Swipe Token Once	Open Door + Disarm Area	Open Door + Disarm Area
<b>Area Is Off</b>		
Swipe Token Once	Open Door + Turn Area All On	Open Door
Swipe Token 3 Times Within 5 Seconds		Open Door + Turn Area All On
Swipe Token 4 Times Within 5 Seconds		Open Door + Turn Area All On, Switches To Part On

Table 26: Badging Examples

**Enable Egress Input**

this option when selected will enable the egress input on the rear of the control console. Where the console is then assigned to a door triggering this input will then trigger the door to operate for the programmed time thus allowing access.

**Log Egress Events**

There can be many Egress events per day on an access control system which can clutter the history log over time. If you enable the Log Egress Events option then the egress events are recorded into the history log for later review.

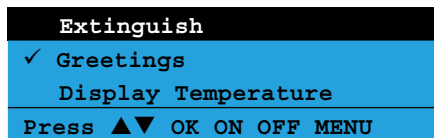
Devices &gt; Keypads &amp; Readers &gt;

**Indicator Options****I** MENU 6-1-5

1	Extinguish	N
2	Greetings	Y
3	Display Temperature	N
4	Display Area Icons	N
5	Trouble Alert Beeps	Y
6	Entry Exit Warning	Y
7	Part Exit Warning	N
8	Chime Tone	Y

This menu allows you to program various options for each LAN keypad, LAN reader or LAN fingerprint reader. Keypads that have an in-built proximity reader, the parameters set when selecting the keypad is common for both the keypad and in-built reader.

- 1) Press [MENU] + [6] + [1] + [5] and use the up and down arrows to highlight the keypad in the list then press [OK].



- 2) Use the up and down arrow keys to highlight the option then press the [ON] key to enable or the [OFF] key to disable.
- 3) Repeat Step 2 until all options are programmed as required, then press [OK] to save and exit or press [MENU] to exit without saving.

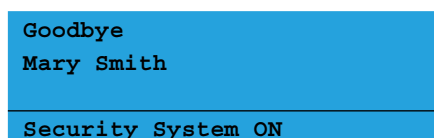
**Extinguish**

This option allows the LAN device (eg. keypad, proximity reader or fingerprint reader) to automatically turn off all key backlighting and status LED's when there is no activity for approximately 4 minutes. As soon as an alarm occurs or user activity on the LAN device, the backlighting and/or status LED's will return to normal.

**Greetings**

This option allows the keypad to briefly display on the top line the greeting message when a user turns an area on or off.

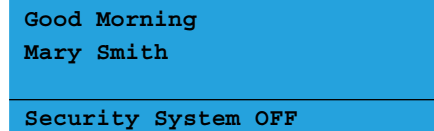
When turning an area All On, Part On or Part 2 On, the greeting message 'Goodbye' along with their user name on the second line will be displayed:



when turning an area off from All On, Part On or Part 2 On, the greeting message will be displayed on the top line along with their user name on the second line.

The following greeting messages are as follows:

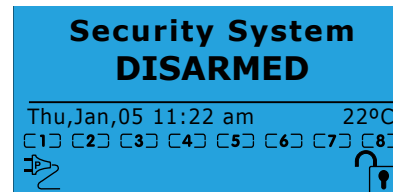
- ❖ Good Morning Greeting = 00:00 to 11:59
- ❖ Good Afternoon Greeting = 12:00 to 17:59
- ❖ Good Evening Greeting = 18:00 to 23:59

**Display Temperature**

This option allows the keypad to display the reading of the keypad temperature when a keypad idle screen has been programmed. Each keypad can display its own temperature.

**Display Area Icons**

This option allows the keypad to display the area icons 1 to 8. This allows the users to determine which areas are turned All On or Part On from a single keypad without the need to either move the keypad display to view each area or walk to each area keypad.

**Trouble Alert Beeps**

This option allows the LAN device (keypad, proximity reader or fingerprint reader) to sound a trouble tone when the system has detected a trouble condition.

**Entry Exit Warning**

This option allows the LAN device (keypad, proximity reader or fingerprint reader) to sound the entry warning tone or sound the exit warning tone when a user turns an area All On.

**Part Exit Warning**

This option allows the LAN device (keypad, proximity reader or fingerprint reader) to sound the exit warning tone when a user turns the area Part On or Part 2 On.

If this option is not programmed, the keypad will only sound a single beep at the end of the part exit time.

**Chime Tone**

This option allows the LAN device (keypad, proximity reader or fingerprint reader) to sound the chime tone when a zone set to be monitored when chime mode is turned on is faulted. If this option is not programmed, the LAN device will not sound the chime tone when a

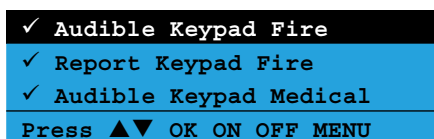
chime zone is faulted.

Devices > Keypads & Readers >

Emergency Keys		MENU 6-1-6
1	Audible Keypad Fire	Y
2	Report Keypad Fire	Y
3	Audible Keypad Medical	Y
4	Report Keypad Medical	Y
5	Audible Keypad Panic	Y
6	Report Keypad Panic	Y
7	Reserved	N
8	Reserved	N

The above options can be configured independently for each keypad fitted to the system.

- 1) Press [MENU] + [6] + [1] + [6] and use the up and down arrows to highlight the keypad in the list then press [OK].



- 2) Use the up and down arrow keys to highlight the option then press the [ON] key to enable or the [OFF] key to disable.
- 3) Repeat Step 2 until all options are programmed as required, then press [OK] to save and exit or press [MENU] to exit without saving.

### Audible Keypad Fire

Setting this option allows the panel to sound an audible alarm when a Keypad Fire Emergency Alarm has been triggered via the keypad. To initiate a fire emergency via the keypad, press and hold the [4] + [6] keys or the [←] + [→] keys down for two seconds. Enter a valid user PIN to reset the alarm condition.

### Report Keypad Fire

Setting this option allows the panel to send a Fire report to the base station when a Keypad Fire Emergency Alarm has been triggered via the keypad.

### Audible Kpad Medical

Setting this option allows the panel to sound an audible alarm when a Keypad Medical Emergency Alarm has been triggered via the keypad. To initiate a medical emergency via the keypad, press and hold the [7] + [9] keys or the [↑] + [↓] keys down for two seconds. Enter a valid user PIN to reset the alarm condition.

### Report Kpad Medical

Setting this option allows the panel to send a Medical report to the base station when a Keypad Medical Emergency Alarm has been triggered via the keypad.

### Audible Kpad Panic

Setting this option allows the panel to sound an audible alarm when a Keypad Panic Emergency Alarm has been triggered via the keypad. To initiate a panic emergency via the keypad, press and hold the [1] + [3] keys or the [→] + [↑] keys down for two seconds. Enter a valid user PIN to reset the alarm condition.

**Note** If this option is disabled, a keypad panic alarm will not be visible on the keypad display (i.e. Invisible Panic Alarm).

### Report Keypad Panic

Setting this option allows the panel to send a Panic report to the base station when a Keypad Panic Emergency Alarm has been triggered via the keypad.

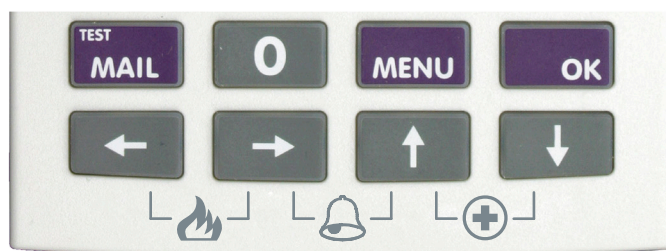


Figure 26: Keypad Emergency Keys

Labelling can be applied to the keypad to further simplify operation.

KEYPAD EMERGENCY ALARM TRIGGER'S	
Key Sequence	Event Triggered
[←] + [→] Hold for 2 seconds	Keypad Fire Alarm
[→] + [↑] Hold for 2 seconds	Keypad Panic Alarm
[↑] + [↓] Hold for 2 seconds	Keypad Medical Alarm

Table 27: Keypad Emergency Keys

Devices &gt; Keypads &amp; Readers &gt;

**Door Assignment****I** MENU 6-1-7

0 0

- |                         |                   |
|-------------------------|-------------------|
| 00 - No Door Assignment | 09 - Door 9 Name  |
| 01 - Door 1 Name        | 10 - Door 10 Name |
| 02 - Door 2 Name        | 11 - Door 11 Name |
| 03 - Door 3 Name        | 12 - Door 12 Name |
| 04 - Door 4 Name        | 13 - Door 13 Name |
| 05 - Door 5 Name        | 14 - Door 14 Name |
| 06 - Door 6 Name        | 15 - Door 15 Name |
| 07 - Door 7 Name        | 16 - Door 16 Name |
| 08 - Door 8 Name        |                   |

This menu allows the installer to assign each keypad to a single door group. 16 different door groups are available. Programming a door group of zero (disabled) allows a user from any access group to operate the keypad.

- 1) Press [MENU] + [6] + [1] + [7] and use the up and down arrows to highlight the keypad or LAN reader in the list then press [OK]. Alternatively, you can enter the keypad or LAN reader number directly and press [OK]. The keypad will display the current door assignment setting.

```
Door Assignment Kp1
00 - No Door Assignment
Press ▲▼ 0-9 OK to SAVE
```

- 2) Use the up and down arrows to select the door assignment that you want to assign the keypad or LAN reader to.
- 3) Press [OK] to save and exit or press [MENU] to exit without saving.

Devices &gt; Keypads &amp; Readers &gt;

**Lockout Time****I** MENU 6-1-8

(\*\*\*) System Wide Parameter (\*\*\*)

0 6 0

Seconds

This menu programs how long a keypad will be quarantined if the PIN retry count value is exceeded. See MENU 1-5-1 — PIN Retry Count. The PIN retry counter is reset when any area is armed or disarmed using a valid PIN.

- 1) Press [MENU] + [6] + [1] + [8]. The keypad will display the current keypad lockout time.

```
Lockout Time
060 Seconds
Press 0-9 OK to SAVE
```

- 2) Use the numeric keys to program the number of seconds the keypad will be locked out for. Valid entries are 0 - 255, 0 = No Lockout.
- 3) Press [OK] to save and exit, else press [MENU] to exit without saving.

## RF RECEIVER OPTIONS

Devices > RF Devices >

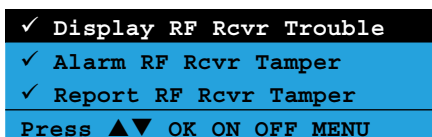
### Receiver Options

**I** MENU 6-2-0

1	Display RF Rcvr Trouble	Y
2	Alarm RF Rcvr Tamper	Y
3	Report RF Rcvr Tamper	Y
4	Alarm RF Rcvr Jamming	N
5	Report RF Rcvr Jamming	N
6	Alarm Rcvr Comms Fail	Y
7	Report Rcvr Comm Fail	Y
8	Reserved	N

This menu option allows you to configure the various RF receiver functions. Only one RF receiver can be fitted per panel.

- 1) Press [MENU] + [6] + [2] + [0]. The keypad will display the current receiver options.



- 2) Use the up and down arrow keys to highlight the option then press the [ON] key to enable or the [OFF] key to disable.
- 3) Repeat Step 2 until all options are programmed as required, then press [OK] to save and exit or press [MENU] to exit without saving.

### Display RF Rcvr Trouble

Setting this option allows the panel to display a trouble condition on the keypad when an RF receiver fail condition occurs.

### Alarm RF Rcvr Tamper

Setting this option allows the panel to trigger an alarm when the RF receiver tamper circuit is tripped.

### Report RF Rcvr Tamper

Setting this option allows the panel to send an RF Receiver Tamper report to the base station when the RF receiver tamper circuit is tripped. A restore report will be sent when the tamper circuit is resealed.

### Alarm RF Rcvr Jamming

Setting this option allows the panel to sound an alarm when the RF Receiver detects a jamming signal. This signal may not be provided by all compatible RF Receivers.

### Report RF Rcvr Jamming

Setting this option allows the panel to send an RF Receiver Jam report to the base station when the RF Receiver detects a jamming signal. A restore report will be sent as soon as the jamming signal stops.

### Alarm Rcvr Comm Fail

Setting this option allows the panel to sound an alarm when it is unable to communicate with the RF Receiver.

### Report Rcvr Comm Fail

Setting this option allows the panel to send an RF Receiver Comms Fail report to the base station when the panel is unable to communicate with the RF Receiver. A restore report will be sent as soon as communication is restored between the panel and the RF receiver.

Device > RF Devices >

### Supervision Time

**I** MENU 6-2-1

(\*\*\* System Wide Parameter \*\*\*)

0 2 4

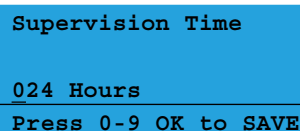
HOURS

This menu sets the global RF supervision time for all RF devices connected to the system.

RF transmitters (sensor devices) will send a supervisory test signal approximately once every hour. The RF receiver expects to receive this supervisory signal from every transmitting device within the supervision time period.

The panel will send a Missing report to the base station for any RF device that fails to report within the supervision time.

- 1) Press [MENU] + [6] + [2] + [1]. The keypad will display the current RF supervision time.



- 2) Using the numeric keys, enter the number of hours for the RF supervision time. Valid times are 0 - 255 hours, 0 = No Supervision.
- 3) Press [OK] to save and exit or press [MENU] to exit without saving.

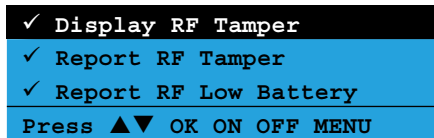
Device &gt; RF Devices &gt;

**RF Device Options****I** MENU 6-2-2

1	Display RF Tamper	Y
2	Report RF Tamper	Y
3	Report RF Low Battery	Y
4	Report Lost RF Devices	Y
5	Open Zone On Lost RF	N
6	Audible Keyfob Panic	Y
7	Report Keyfob Panic	Y
8	Keyfob Func Part On	Y

This menu option allows you to configure various options and functions for RF devices connected to the system.

- 1) Press [MENU] + [6] + [2] + [2]. The keypad will display the current RF Device Options.



- 2) Use the up and down arrow keys to highlight the option then press the [ON] key to enable or the [OFF] key to disable.
- 3) Repeat Step 2 until all options are programmed as required, then press [OK] to save and exit or press [MENU] to exit without saving.

**Display RF Tamper**

Setting this option will cause the keypad to display the RF zone when a tamper condition occurs.

**Report RF Tamper**

Setting this option will cause the panel to send an RF Device Faulted report to the base station when the devices tamper circuit is tripped. A restore report will be sent when the tamper circuit is resealed.

**Report RF Low Battery**

Setting this option will cause the panel to send a report to the base station when the RF device signals to the panel that it has a low battery condition.

**Report Lost RF Devices**

Setting this option will cause the panel to send a report to the base station if the panel detects that an RF device is missing.

**Open Zone On Lost RF**

Setting this option will cause the panel to show a zone fault on the keypad for any RF devices that are missing

**Audible Keyfob Panic**

Setting this option allows users who have RF keyfobs to trigger an audible panic alarm via the keyfob.

**Report Keyfob Panic**

Setting this option will cause the panel to send a Panic report to the base station when a panic alarm has been initiated via a key fob.

**Keyfob Func Part On**

Setting this option will allow keyfob users to arm an area or all areas of the system using function key 1 on the keyfob.

Devices &gt; RF Devices &gt;

**Add RF Keypad****I** MENU 6-2-3

Reserved for future use.

**Delete RF Keypad****I** MENU 6-2-4

Reserved for future use.

**View RF Device ID****I** MENU 6-2-5

This command allows you to trap and view a transmitters I.D. number when it has been forgotten or it is no longer legible on the transmitter label. The device being tested must be compatible with the RF receiver fitted to the panel.

- 1) Press [MENU] + [6] + [2] + [5]. The system will then begin waiting for a valid trigger signal.

- 2) Trigger the transmitter by pressing any button on the keyfob or by triggering the tamper switch on any sensor.

- 3) To test another transmitter, repeat step 2. A beep will be heard each time a new RFID is received and the new number will be displayed.

## SERIAL DEVICE OPTIONS

Devices > Serial Device >

### Device Type

**I** MENU 6-3-0

- 00 - Disabled
- 01 - Serial Printer
- 02 - Computer

00

This menu sets the type of serial device that the panel will be connected to.

- 1) Press [MENU] + [6] + [3] + [0]. The keypad will display the current device type.

```
Device Type
00 - Disabled
Press ▲▼ 0-9 OK to SAVE
```

- 2) Use the up and down arrow keys to select the Device Type required then press [OK] to save and exit or press [MENU] to exit without saving.

Devices > Serial Device >

### Baud Rate

**I** MENU 6-3-1

- 00 - No Device Conn
- 01 - 300 Baud
- 02 - 600 Baud
- 03 - 1200 Baud
- 04 - 2400 Baud
- 05 - 9600 Baud
- 06 - 19200 Baud

00

This menu sets the baud rate or speed that the panel will send data to the serial device. This should be set to the same baud rate as the serial device.

- 1) Press [MENU] + [6] + [3] + [1]. The keypad will display the current baud rate.

```
Baud Rate
00 - No Device Conn
Press ▲▼ 0-9 OK to SAVE
```

- 2) Use the up and down arrow keys to select the Baud Rate required then press [OK] to save and exit or press [MENU] to exit without saving.

Devices > Serial Device >

### Flow Control

**I** MENU 6-3-2

- 00 - No Handshake
- 01 - Hardware
- 02 - Xon/Xoff

00

This menu sets the appropriate flow control for the device you are connecting the serial board to. The flow control method must be the same on both devices for a serial connection to be established.

- 1) Press [MENU] + [6] + [3] + [2]. The keypad will display the current flow control setting.

```
Flow Control
00 - No Handshake
Press ▲▼ 0-9 OK to SAVE
```

- 2) Use the up and down arrow keys to select the Flow Control required then press [OK] to save and exit or press [MENU] to exit without saving.

Devices > GSM/GPRS Module >

### GSM/GPRS Status

**I-M** MENU 6-5-0

This command interrogates the GSM module and displays information about the radio and the SIM installed. The first line is a heading which indicates the GSM module type that is installed. Typical information available is details on the installed radio, the SIM provider and signal strength of the currently active SIM. It should be noted that the use of SIM 2 is restricted to reporting protocols that utilise the dual sim where SIM 2 is a backup.

```
GSM/GPRS 2G Module G11
<Scroll Parameters Here>
Press ▲▼ OK or MENU
```

The following parameters will be scrolled one at a time through the display.

IMEI=19327130710103097

Radio Model=SL6087

Radio Firmware=Rev 1.96

Radio S/N=If this is available not sure

Provider=Sim1 YES Optus or Sim2 YES Optus

Signal Strength= Sim1 10dB or Sim2 11 dB

Dual Sims Detected

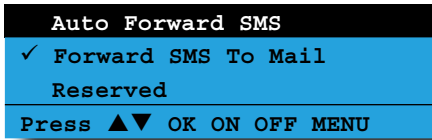
Devices > GSM/GPRS Module >

**GSM/GPRS Options** I MENU 6-5-1

1	Auto Forward SMS	N
2	Forward SMS To Mail	Y
3	Reserved	N
4	Reserved	N
5	Reserved	N
6	Reserved	N
7	Reserved	N
8	Reserved	N

This menu option allows you to configure various options and functions for GSM or GPRS devices connected to the system.

- 1) Press [MENU] + [6] + [5] + [1]. The keypad will display the current RF Device Options.



- 2) Use the up and down arrow keys to highlight the option then press the [ON] key to enable or the [OFF] key to disable.
- 3) Repeat Step 2 until all options are programmed as required, then press [OK] to save and exit or press [MENU] to exit without saving.

**Auto Forward SMS**

Any SMS received by the GSM module will be automatically forwarded to the mobile telephone number programmed in MENU 6-5-7.

**Forward SMS To Mail**

Any SMS received by the GSM module will be automatically forwarded to the keypad (brings up Main icon). SMS commands will be filtered (eg. ,PIN., AREA1,ON).

Devices > GSM/GPRS Module >

**CLI Trigger Table 1** I-M MENU 6-5-5-0

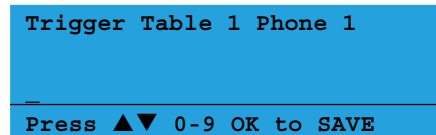
Phone 1	1 Digits	16
Phone 2	1 Digits	16
Phone 3	1 Digits	16
Phone 4	1 Digits	16
Phone 5	1 Digits	16
Phone 6	1 Digits	16
Phone 7	1 Digits	16
Phone 8	1 Digits	16
Phone 9	1 Digits	16
Phone 10	1 Digits	16

**GSM MODULE REQUIRED)** The CLI trigger table allows you to program up to 10 telephone numbers that the control panel will automatically identify when you call the control panel to operate an output - see Output Event type 71. Program the output event assignment as 1 so that the output follows CLI trigger table 1.

- 1) Enter [MENU] + [6] + [5] + [5] + [0]. The keypad will display the following:



- 2) Highlight the telephone number that you want to program for CLI trigger, then press [OK] to select.



- 3) Using the numeric keys, enter the telephone number that you wish to program.
- 4) Press [OK] to save and return to the CLI table, otherwise press [MENU] to exit without saving.



Devices > GSM/GPRS Module >

**CLI Trigger Table 2**

**I-M MENU 6-5-5-1**

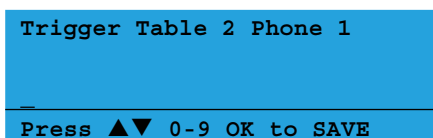
	1	Digits	16
Phone 1	<input type="text"/>	<input type="text"/>	<input type="text"/>
Phone 2	<input type="text"/>	<input type="text"/>	<input type="text"/>
Phone 3	<input type="text"/>	<input type="text"/>	<input type="text"/>
Phone 4	<input type="text"/>	<input type="text"/>	<input type="text"/>
Phone 5	<input type="text"/>	<input type="text"/>	<input type="text"/>
Phone 6	<input type="text"/>	<input type="text"/>	<input type="text"/>
Phone 7	<input type="text"/>	<input type="text"/>	<input type="text"/>
Phone 8	<input type="text"/>	<input type="text"/>	<input type="text"/>
Phone 9	<input type="text"/>	<input type="text"/>	<input type="text"/>
Phone 10	<input type="text"/>	<input type="text"/>	<input type="text"/>

**(GSM MODULE REQUIRED)** The CLI trigger table allows you to program up to 10 telephone numbers that the control panel will automatically identify when you call the control panel to operate an output - see Output Event type 71. Program the output event assignment as 2 so that the output follows CLI trigger table 2.

- 1) Enter [MENU] + [6] + [5] + [5] + [1]. The keypad will display the following:



- 2) Highlight the telephone number that you want to program for CLI trigger, then press [OK] to select.



- 3) Using the numeric keys, enter the telephone number that you wish to program.
- 4) Press [OK] to save and return to the CLI table, otherwise press [MENU] to exit without saving.

Devices > GSM/GPRS Module >

**SMS Control**

**I-M MENU 6-5-6**

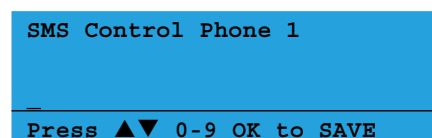
	1	Digits	16
Phone 1	<input type="text"/>	<input type="text"/>	<input type="text"/>
Phone 2	<input type="text"/>	<input type="text"/>	<input type="text"/>
Phone 3	<input type="text"/>	<input type="text"/>	<input type="text"/>
Phone 4	<input type="text"/>	<input type="text"/>	<input type="text"/>
Phone 5	<input type="text"/>	<input type="text"/>	<input type="text"/>
Phone 6	<input type="text"/>	<input type="text"/>	<input type="text"/>
Phone 7	<input type="text"/>	<input type="text"/>	<input type="text"/>
Phone 8	<input type="text"/>	<input type="text"/>	<input type="text"/>
Phone 9	<input type="text"/>	<input type="text"/>	<input type="text"/>
Phone 10	<input type="text"/>	<input type="text"/>	<input type="text"/>

**(GSM MODULE REQUIRED)** The SMS control table allows you to program up to 10 telephone numbers that the control panel will automatically identify when you send SMS commands to operate the control panel.

- 1) Enter [MENU] + [6] + [5] + [6]. The keypad will display the following:



- 2) Highlight the telephone number that you want to restrict for SMS control, then press [OK] to select.



- 3) Using the numeric keys, enter the telephone number that you wish to program.
- 4) Press [OK] to save and return to the restrict SMS control table, otherwise press [MENU] to exit without saving.

Devices &gt; Ethernet Module &gt;

**Module IP Address****I** MENU 6-6-0

1	Digits	12
0 0 0	0 0 0 0 0 0	0 0 0 0 0 0

This is the IP address of the TCP/IP module on the customer's internal local area network.

- 1) Press [MENU] + [6] + [6] + [0]. The keypad will display the current IP address.

```

Module IP Address
000000000000
Press 0-9 OK to SAVE
  
```

- 2) Use the numeric keys [0] to [9] + [←] and [→] keys to program the IP Address, then press [OK] to save and exit or press [MENU] to exit without saving.

Devices &gt; Ethernet Module &gt;

**Subnet Mask****I** MENU 6-6-1

1	Digits	12
0 0 0	0 0 0 0 0 0	0 0 0 0 0 0

The can be found by running IPCONFIG on a PC connected to the clients network. Typical subnet mask is 255.255.255.0.

- 1) Press [MENU] + [6] + [6] + [1]. The keypad will display the current subnet mask.

```

Subnet Mask
000000000000
Press 0-9 OK to SAVE
  
```

- 2) Use the numeric keys [0] to [9] + [←] and [→] keys to program the 12 digit subnet mask number, then press [OK] to save and exit or press [MENU] to exit without saving.

Devices &gt; Ethernet Module &gt;

**Default Gateway****I** MENU 6-6-2

1	Digits	12
0 0 0	0 0 0 0 0 0	0 0 0 0 0 0

The can be found by running IPCONFIG on a PC connected to the clients network.

- 1) Press [MENU] + [6] + [6] + [2]. The keypad will display the current gateway number.

```

Default Gateway
000000000000
Press 0-9 OK to SAVE
  
```

- 2) Use the numeric keys [0] to [9] + [←] and [→] keys to program the 12 digit gateway number, then press [OK] to save and exit or press [MENU] to exit without saving.

Devices &gt; Ethernet Module &gt;

**Module MAC Address****I** MENU 6-6-3

0 0	0 0	0 0	0 0	0 0	0 0
-----	-----	-----	-----	-----	-----

This is the hardware machine address of the module and can be found on the bar-coded sticker.

- 1) Press [MENU] + [6] + [6] + [3]. The keypad will display the current MAC address.

```

Module MAC Address
000000000000
Press ◀▶▲▼ OK to SAVE
  
```

- 2) Use the numeric keys [0] to [9] + [←] and [→] keys to program the MAC address, then press [OK] to save and exit or press [MENU] to exit without saving. This is the hardware machine address of the module and can be found on the bar-coded sticker.

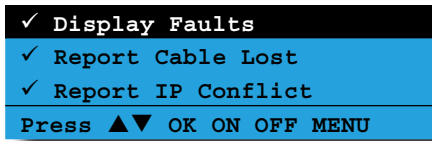
Devices &gt; Ethernet Module &gt;

**Ethernet Options****I** MENU 6-6-9

1	Display Faults	Y
2	Report Cable Lost	Y
3	Report IP Conflict	Y
4	Report Poll Fail	Y
5	Reserved	N
6	Reserved	N
7	Reserved	N
8	Reserved	N

This menu option allows you to configure the various RF receiver functions. Only one RF receiver can be fitted per panel.

- 1) Enter your Installer PIN + [MENU].
- 2) Enter [6] + [6] + [9] + [OK].  
The keypad will display the current options which are selected or enabled.



- 3) Use the numeric keys [1] to [8] to turn on and off the features as required. When the corresponding number on the keypad is on then the option is selected.
- 4) When all options are programmed, press [OK] to save and exit, or press [MENU] to exit without saving.

### **Display Faults**

This option allows the keypad to display a trouble condition if the control panel detects when the ethernet module is missing, the module IP is changed, there is no connection, there is an IP lockout or there is an IP conflict.

### **Report Cable Lost**

This option allows the control panel to report when it detects that the LAN cable is missing via the dialler.

### **Report IP Conflict**

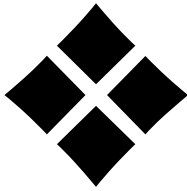
This option allows the control panel to report an IP conflict via the dialler when it detects two computers on the LAN or internet have been assigned the same IP address.

### **Report Poll Fail**

This option allows the control panel to report via the dialler when the ethernet module fails to send a poll to the base station.

» » E N D O F S E C T I O N « «

**This page left intentionally blank**



# System Programming

This section contains the different parameters required that are system related features.

The commands menu will allow you to view the panel status, system troubles, history log, factory default and entering service mode.

Some of the key parameters in these menus are the setting of the date/time under Clock and Schedules which control all the automated time functions of the system.

## SYSTEM COMMANDS

System > Commands >

Panel Status



MENU 7-0-0

This command displays the following panel related information on the keypad display.

### Line 1 Displays:

The panel number that you are getting information from (eg. Node 1 = Panel 1 etc). The Solution 144 is only configured to work with one panel.

### Line 2 Displays:

The panel name and firmware version number.

### Line 3 Displays:

The current panel temperature, panel power supply voltage and any system troubles which are in effect. This line scrolls all events continuously

- 1) Press [MENU] + [7] + [0] + [0] to view the panel status.

```
Panel 1
Solution 144 Ver 2.00.00
Temperature = 33
Press OK or MENU
```

- 2) Press [OK] to exit when finished.

System > Commands >

System Trouble



MENU 7-0-1

This command lists any system troubles which are currently in effect on the system. Information is displayed in a list format allowing you to select a particular event and then drill down to view more specific information.

System trouble events such as Failure To Communicate or Telco Line Fail are grouped under System Trouble in the list while open zones are displayed individually one per line.

When the keypad is in standby mode, system troubles and open zones will be displayed on the status line of the keypad. From this mode you can access the list of troubles by pressing the down arrow.

- 1) Press [MENU] + [7] + [0] + [1] and use the up and down arrows to highlight the trouble event in the list then press [OK].

```
System Trbl
Zn1 Zone 1 Name
Zn2 Zone 2 Name
Press ▲▼ OK or MENU
```

- 2) Selecting System Trouble from the list will show the specific panel version information to be displayed in the first two lines while the third line of the display will scroll all current system trouble events.

```
Panel 1
Solution 144 Ver 2.00.00
Date and Time
Press OK or MENU
```

- 3) Selecting a Zone from the list will show the current zone state.

```
Zone 1 Zame Zn1
EOL=Open 53020 ohms
Press OK or MENU
```

- 4) If no System Troubles are in effect the keypad will display.

There are no  
System troubles

Press ▲▼ OK or MENU

- 5) Press [OK] or [MENU] when finished.



When in stand-by mode keypads will display system trouble events on the third line of the display.

## SYSTEM TROUBLE MESSAGES

The following list shows the systems trouble messages including a description of what has caused the trouble event to occur. System Trouble events are also recorded in the System Event Log.

### Power Missing

This trouble message will display when the AC mains power supply to the panel is disconnected or failed and will clear when the power is reconnected. The Mains Power Icon in the keypad will also flash when the power is missing.

### AC Missing

The control panel has detected that the AC mains supply has failed or is disconnected on an optional universal expander or LAN power supply module.

### Battery Low

This trouble message will display if the panel's backup battery voltage has dropped below 11.5 volts DC during a battery test and will clear when the voltage is above 12.5 volts during a subsequent battery test.

### Battery Missing

This trouble message will display if the panel detects that the system's backup battery is missing or has been disconnected.

### Low Battery

The control panel has detected that an RF sensor has a low battery condition. Replace the RF sensor battery and transmit an RF signal to clear the low battery condition.

### Box Tamper

The control panel has detected that the tamper circuit on the LAN power supply module is faulted. Place a shunt across the tamper input pins or close the tamper circuit to clear the box tamper trouble condition.

### Temperature Alert

The control panel has detected that the console (eg. keypad, LAN reader or fingerprint reader) has exceeded the global temperature high or temperature low settings.

### Receiver Missing

This trouble message will display if the panel detects the RF receiver is missing or disconnected. The trouble will clear when the receiver is reconnected.

### Case Tamper

This trouble message will display if the panel detects that the tamper circuit on the RF receiver is faulted.

### Receiver Jam

This trouble message will display if the connected RF receiver detects RF noise levels that may prevent it from working correctly.

### Comms Fail Route1

This trouble message will display if the panel has failed to send pending reports to Report Destination 1. All possible call attempts will be made before the trouble message is displayed.

### Comms Fail Route2

This trouble message will display if the panel has failed to send pending reports to Report Destination 2. All possible call attempts will be made before the trouble message is displayed.

### Sensor Watch Alert

The control panel has detected a zone has failed to detect a change of state within the sensor watch period.

### Comms BUSS Trble

This trouble message will display if the panel failed to communicate to a system device which is connected to the LAN bus (e.g. keypad etc).

### Default PIN Trble

This trouble message will display if the panel detects that either the Installer PIN or User 1 PIN is still set to the factory default PIN. Change the PIN to clear the fault.

### Date & Time

This trouble message will display if the system date and time has not been set. Program the correct date and time to clear the fault.

### Cabinet Tamper

This trouble message will display if the panel detects that it's cabinet tamper input is faulted. Close the tamper switch to clear the fault.

### Connection Trouble

The control panel has detected that an output device (eg. external siren etc) has failed or has been disconnected from the system.

### Overload Condition

The control panel has detected that an output has an over current condition.

**Zone Was In Alarm**

A zone was previously in alarm and requires alarm memory reset to clear. Turn the area on and then off again to clear alarm memory.

**Telco Line Fail**

This trouble message will display if the panel detects that the telephone line has failed or been disconnected for a minimum of 30 seconds. The trouble will clear once the line has been restored for at least 1 minute.

**LAN+ Overload**

This trouble message will display if the panel detects that the current load on the LAN+ power terminal has exceeded its maximum rating of 1Amp DC. See MENU 7-3-2 — Fuse Options.

**COMM+ Overload**

This trouble message will display if the panel detects that the current load on the COMM+ terminal has exceeded its maximum rating of 3Amp DC. See MENU 7-3-2 — Fuse Options.

**ACC+ Overload**

This trouble message will display if the panel detects that the current load on the +12V accessory power terminal has exceeded its maximum current rating of 1Amp D.C. See MENU 7-3-2 — Fuse Options.

**Service Required**

This trouble message will display when the Service Interval Timer expires. To clear the message the installer must enter and exit programming mode. See MENU 2-9-2 — Service Interval.

**Memory Checksum**

This occurs if the memory checksum is corrupted. To try and correct this, enter programming mode and make a programming change like a user name then exit programming mode. If this problem still persists you must do a full system default.

**Phone Line In Use**

This trouble message will display while the panel is using the phone line. The message will clear when the line is released. This message can be prevented from displaying in MENU 5-2-2 — Phone Line Options.

**Battery Trouble**

The control panel has detected that the real time clock module has a low or missing backup battery.

System &gt; Commands &gt;

**History Log**

I - M - U

**MENU 7-0-2**

This menu allows you to review the last 1000 recorded history events on your system. The information for each event may be displayed over a number of pages or screens depending on the actual event recorded.

When you enter this menu the system will show you the most recent event first. Once the log reaches the maximum event capacity each new event will replace the oldest event in the log in a first in , first out fashion.

To move from one log event to the next use the [↑] and [↓] keys or if you know the event number you are looking for simply enter the number followed by the [OK] key and the system will display that event.

A left [◀] and right [▶] arrow will may be displayed at the end of the first line on each log screen. These indicate that the history log contains more than one page for the current event. To view these pages use the [←] and [→] keys.

To review the History Log enter programming mode (PIN + MENU) then,

- 1) Press [MENU] + [7] + [0] + [2].
- 2) The keypad will display the most recent event stored in the history log.

```
E001 Mon,01Apr 02:00:00 ▶
Manual Test Report
Panel 1
```

```
E001 Dest= SLL----- ◀
PSTN Ph-96561234
```

- 3) Use the [↑] and [↓] keys scroll between history events and use the [←] and [→] keys to view the pages within the event.
- 4) Press [OK] or [MENU] to exit.

Some other examples of the log are as follows:

1)

```
E202 Sun,01Apr 03:41:45 ▶
Disarmed by User
Area 1 Name
Ur1 User 1 Name
```

```
E202 Dest= SLL----- ◀
Kp1 Keypad 1 Name
Panel 1
Dest 1 at 01-Apr 03:41:57
```

2)

```
E405 Sun,01Apr 06:41:45 ▶
Burglary Zone Bypassed
Area 1 Name
Zn3 Zone 3 Name
```

```
E405 Dest= SLL----- ◀
Ur1 User 1 Name
Panel 1
Dest 1 at 01-Apr 06:41:57
```

The Dest= field displays the various reporting route information for up to eight different reporting destinations. Your installer will have configured these during installation.

The following letters will be displayed in the eight destination locations indicating the status of the report. The log will also show the actual time a report was sent.

Dest =

- S = Sent
- L = Logged
- P = Pending
- F = Failed
- A = Aborted

System > Commands >

**Domestic Default**

**MENU 7-0-3**

This command will configure the control panel for Domestic format reporting (eg. mobile telephones etc). All alarm restore reports and open/close reporting options will be automatically disabled. Therefore, only emergency, burglary and fire reports will be sent.

The following table list the changes that will occur when you select domestic default using MENU 7-0-3.

Program Option	Domestic Default Value
All Trouble Reports	Disabled
All Bypass Reports	Disabled
All Restore Reports	Disabled
Destination 1 TX Format	Domestic Reporting
Access Route	Log Only
Open / Close Reports	Log Only
Test Route	Log Only
System Route	Log Only

**Table 28: Domestic Default Settings**

- 1) Press [MENU] + [7] + [0] + [3]. The keypad will display:

```
To RECONFIGURE all panel
dialler programming to
DOMESTIC, Press OK. or To
Cancel, Press MENU.
```

- 2) Press [OK] to start the default process or press [MENU] to cancel and exit.
- 3) The keypad will display the following message during the default process and will exit back to the menu when finished.

```
Defaulting System
..Please Wait..
```

System > Commands >

**Factory Default**

**MENU 7-0-4**

This command will erase ALL programmable data and return the control panel to factory default settings. Defaulting the panel will NOT erase any history events that are currently stored in the panel.



*During a factory default both the Status and Dialler LED indicators on the panel will flash very quickly to indicate defaulting is still in progress.*

- 1) Press [MENU] + [7] + [0] + [4]. The keypad will display:



```
This command will ERASE
all panel programming. To
Continue press OK, or
MENU to cancel
```

- 2) Press [OK] to start the default process or press [MENU] to cancel and exit.
- 3) The keypad will display the following message during the default process and will exit back to the menu when finished.

```
Defaulting System
..Please Wait..
```

System > Commands >



Template Default

 MENU 7-0-5

This command is RESERVED.

System > Commands >

TimeZone Array

  MENU 7-0-6

This menu allows the master user and installer to view the true/false status of all 16 timezones at the same time. The timezone status will continuously be updated on the display so that real time status can be seen. The top two rows of the display show the timezone number, the third row displays the timezone status.

**T** = TimeZone is True

**F** = TimeZone is False

- = Disabled or Not Available

- 1) Enter [MENU] + [7] + [0] + [6] and use the up and down arrows to select the timezone to view. The keypad will display the status of all 16 timezones.

```
0000000011111111
1234567890123456
TTTTT---FFF----
Press ▲▼ OK or MENU
```

In the example above,

**T** = TimeZones 01 to 05 are true


**F** = TimeZones 09 to 12 are false

- = TimeZones 06 to 08 and Doors 13 to 16 are  
Disabled or Not Available

- 2) When finished press [OK] or [MENU] to exit.

System > Commands >

Service Mode

 MENU 7-0-8

This command allows the installer to put the panel into service mode before performing system maintenance or upgrades. When in service mode, the following functions are disabled. By default, service mode will automatically terminate after 2 hours if not terminated sooner by the installer.

- ❖ Zone Tamper
- ❖ Alarm Outputs
- ❖ Dialler
- ❖ Panel Tamper

- 1) Press [MENU] + [7] + [0] + [8]. The keypad will display the current service mode status.

```
Service Mode
Service Mode is OFF,
To turn ON, Press ON.
Press OK or MENU
```

- 2) To turn service mode on, press [ON], or press [OFF] to turn service mode off.
- 3) Press [OK] or [MENU] to exit when finished.



*Service mode will automatically exit after 2 hours if set to do so in MENU 7-7-4 — Installer Options.*

## SYSTEM CLOCK

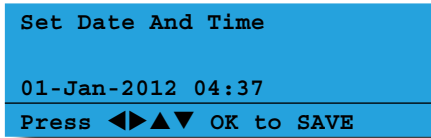
System > Clock >

Set Date And Time

**I**-M MENU 7-1-0

This menu allows you to program and or adjust the date and time stored in the control panel. The time is entered in 24Hr format.

- 1) Press [MENU] + [7] + [1] + [0]. The keypad will display the current date and time.



- 2) Use the left, right, up and down arrow keys to set the day, month, year, hour and minute. Use left and right keys to scroll the cursor left and right to between the month, day, year, hour and minute.
- 3) When the time is set correctly press [OK] to save and exit or press [MENU] to exit without saving.

System > Clock >

Summertime On

**I** MENU 7-1-1

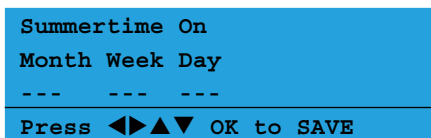
At 2:00am      - - -      - - -      - - -  
 Month            Week            Day

This menu allows you to program when day light savings start during the year. This will allow the panel to automatically adjust it's built in clock accordingly. In Australia, daylight savings moves forward one hour at 2:00 am on the last Sunday of October.

To program Summertime On, you will need to set the month of the year (Jan to Dec), the week of the month (1 to 5) and the day of the week (Sun to Sat) that daylight savings starts.

(\*\*\* System Wide Parameter \*\*\*)

- 1) Press [MENU] + [7] + [1] + [1]. The keypad will display the current Summertime on.



- 2) Use the up and down arrow keys to toggle the month, week and year. Use the left and right keys to move the cursor between the month, week and year.
- 3) When finished press [OK] to save and exit or press [MENU] to exit without saving.

System > Clock >

Summertime Off

**I** MENU 7-1-2

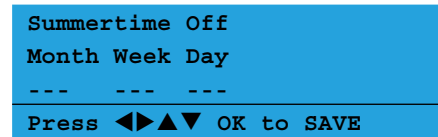
At 2:00am      - - -      - - -      - - -  
 Month            Week            Day

This menu allows you to program when day light savings end during the year. This will allow the panel to automatically adjust it's built in clock accordingly. In Australia, daylight savings moves backwards one hour at 3:00 am on the last Sunday of March.

To program Summertime Off, you will need to program the month of the year (Jan to Dec), the week of the month (1 to 5) and the day of the week (Sun to Sat) that daylight saving ends.

(\*\*\* System Wide Parameter \*\*\*)

- 1) Press [MENU] + [7] + [1] + [2]. The keypad will display the current Summertime off.



- 2) Use the up and down arrow keys to toggle the month, week and year. Use the left and right keys to move the cursor between the month, week and year.
- 3) When finished press [OK] to save and exit or press [MENU] to exit without saving.

### Australian Daylight Savings Times

From 2008, the ACT, NSW, South Australia, Victoria and Tasmania will all start daylight savings on the first Sunday in October and end on the first Sunday in April. This will result in an extra month of daylight savings for the ACT and introduces common start and finish dates in these states.

Daylight Saving Begins	Daylight Saving Ends
Turn Clock Ahead 1 hr	Turn Clock Back 1 hr
Sunday 2 October 2011	Sunday 1 April 2012
Sunday 7 October 2012	Sunday 7 April 2013
Sunday 6 October 2013	Sunday 6 April 2014

Table 29: Daylight Savings Dates - Australia

System &gt; Clock &gt;

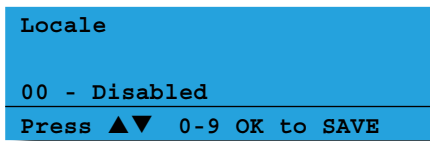
**Locale****I** MENU 7-1-3

00 - Disabled  
 01 - SYDNEY  
 02 - MELBOURNE  
 03 - BRISBANE  
 04 - ADELAIDE  
 05 - PERTH  
 06 - HOBART

(\*\*\*) System Wide Parameter (\*\*\*)

This menu programs the Locale in Australia. It will update the time from a central server every month. Call Charges will apply.

- 1) Press [MENU] + [7] + [1] + [3]. The keypad will display the current locale time.



- 2) Use [↑] and [↓] keys to select the locale required, then press [OK] to save and exit or press [MENU] to exit without saving.

**SYSTEM POWER OPTIONS**

System &gt; Power &gt;

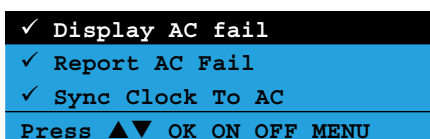
**AC Options****I** MENU 7-3-0

1	Display AC Fail	Y
2	Report AC Fail	Y
3	Sync Clock To AC	Y
4	Random AC Report 2hr	N
5	AC Fail After 1hr	N
6	Reserved	N
7	Reserved	N
8	Display Clock Trouble	Y

(\*\*\*) System Wide Parameter (\*\*\*)

This menu option allows you to configure the AC Mains Power system options.

- 1) Press [MENU] + [7] + [3] + [0]. The keypad will display the current AC Options.



- 2) Use the up and down arrow keys to highlight the option then press the [ON] key to enable or the [OFF] key to disable.
- 3) Repeat Step 2 until all options are programmed as required, then press [OK] to save and exit or press [MENU] to exit without saving.

**Display AC Fail**

Setting this option will cause the panel to flash the Mains Power icon as soon as the AC power supply has failed. If the power remains missing continuously for 1 minute then a system trouble will be registered on the keypad. When the AC power supply returns to normal the Mains Power icon will remain on steady. If this option is disabled then the system will not flash the Mains Power icon and no system trouble will occur.

**Report AC Fail**

Setting this option will cause the panel to report an AC Fail to the base station if the mains power has been missing for a period of 1 minute. A restore report will be sent once the mains power has been restored for one minute.

**Sync Clock to AC**

Setting this option allows the panel to synchronise its internal clock with the mains frequency (50hz). This option should be set unless the panel is being used in an area where the mains power is unreliable.

**Random AC Reporting 2hr**

Setting this option allows the panel to randomly delay (up to 2 hours) the AC Fail report. This option is used to prevent multiple panels from reporting AC fail at the same time.

**AC Fail After 1 Hour**

Setting this option will cause the panel to only send an AC Fail report to the base station if the power has been missing continuously for one hour. The Mains Power icon will operate as normal.

**Display Clock Trouble**

Setting this option will cause the panel to show a Date and Time System trouble if the power is removed from the system for any period of time such as when performing a system upgrade or service work. If this option is disabled then no system trouble will appear and you will need to remember to set the correct time when you re power the system.

System &gt; Power &gt;

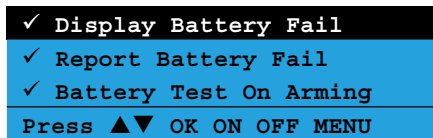
**Battery Options****I** MENU 7-3-1

1	Display Battery Fail	Y
2	Report Battery Fail	Y
3	Battery Test On Arming	Y
4	OKTo Arm Low Battery	Y
5	Reserved	N
6	Reserved	N
7	Reserved	N
8	Reserved	N

(\*\*\*) System Wide Parameter (\*\*\*)

This menu option allows you to configure the standby Battery system options. The system is constantly monitoring the battery condition with a dynamic battery test carried out every 4 hours.

- 1) Press [MENU] + [7] + [3] + [1]. The keypad will display the current Battery Options.



- 2) Use the up and down arrow keys to highlight the option then press the [ON] key to enable or the [OFF] key to disable.
- 3) Repeat Step 2 until all options are programmed as required, then press [OK] to save and exit or press [MENU] to exit without saving.

**Display Battery Fail**

Setting this option will cause the keypad to display a Trouble condition when the panel detects that the standby battery is disconnected or that its voltage is low. The trouble condition will clear as soon as the panel has measured the battery voltage is 12.5 volts or greater.

**Report Battery Fail**

Setting this option will cause the panel to send a Low Battery report to the base station when it measures the battery voltage has dropped below 11.5 volts. A Low Battery Restore report will be sent when the panel detects that the battery voltage is above 12.5 volts.

If the panel fails to detect the battery, or if it measures the battery voltage below 10.2 volts, then a Battery Test Failed report will be sent. A Battery Test restore will be sent when the battery is re-connected or replaced.

**Battery Test On Arming**

Setting this option will cause the panel to perform an additional dynamic battery test each time Area 1 is armed All On.

**OK To Arm Low Battery**

Setting this option will allow the system to be armed even though the panel currently has a low battery condition.

When this option is disabled, the panel will not arm if there is a low battery condition or if the battery is missing. The user will be notified of the system trouble on the keypad and they will need to have the fault rectified before the system or area can be armed.

System &gt; Power &gt;

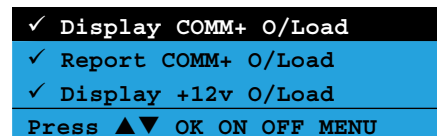
**Fuse Options****I** MENU 7-3-2

1	Display COMM+ O/Load	Y
2	Report COMM+ O/Load	Y
3	Display +12v O/Load	Y
4	Report +12v O/Load	Y
5	Display LAN O/Load	Y
6	Report LAN O/Load	Y
7	Reserved	N
8	Reserved	N

(\*\*\*) System Wide Parameter (\*\*\*)

This menu option allows you to configure the Fuse related system options.

- 1) Press [MENU] + [7] + [3] + [2]. The keypad will display the current Fuse Options.



- 2) Use the up and down arrow keys to highlight the option then press the [ON] key to enable or the [OFF] key to disable.
- 3) Repeat Step 2 until all options are programmed as required, then press [OK] to save and exit or press [MENU] to exit without saving.

**Display COMM+ O/Load**

Setting this option allows the keypad to display a system trouble message when the current load on the COMM + terminal exceeds its maximum rating of 3 Amps.

**Report COMM+ O/Load**

Setting this option will cause the panel to send an Overcurrent Trouble report to the base station when the current load on the COMM + terminal exceeds its maximum rating of 3 Amps.

### Display +12v O/Load

Setting this option allows the keypad to display a system trouble message when the current load on the +12 V terminal exceeds its maximum rating of 1Amp.

### Report +12v O/Load

Setting this option will cause the panel to send an Overcurrent Trouble report to the base station when the current load on the +12 V terminal exceeds its maximum rating of 1Amp.

### Display LAN O/Load

Setting this option allows the keypad to display a system trouble message when the current load on the LAN+ terminal exceeds its maximum rating of 1Amp.

### Report LAN O/Load

Setting this option will cause the panel to send an Overcurrent Trouble report to the base station when the current load on the LAN+ terminal exceeds its maximum rating of 1Amp.

## HORN SPEAKER OPTIONS

System > Siren >

### Tone

**I** MENU 7-4-0

This menu allows you to customise the tone that is emitted from the horn speaker when a non-fire alarm is triggered. By changing the tone and speed, it is possible to program a unique siren sound for each system when you are installing a number of them in close proximity to each other.

- 1) Press [MENU] + [7] + [4] + [0]. The keypad will display the current siren tone.



- 2) Use the up and down arrow keys to change the the siren tone.
- 3) To test the new siren tone press [ON] to sound the siren and press [OFF] to turn the siren off.
- 4) Repeat Steps 2 and 3 until the desired siren tone is achieved then press [OK] to save and exit, or press [MENU] to exit without saving.



Only outputs programmed as Event Type 36 and or 37 will be affected by this menu option.

System > Siren >

### Speed

**I** MENU 7-4-1

This menu allows you to customise the speed of the siren tone when a non-fire alarm is triggered. By changing the tone and speed, it is possible to program a unique siren sound for each system when you are installing a number of them in close proximity to each other.

- 1) Press [MENU] + [7] + [4] + [1]. The keypad will display the current siren speed.



- 2) Use the up and down arrow keys to change the siren speed.
- 3) To test the new siren speed press [ON] to sound the siren and press [OFF] to turn the siren off.
- 4) Repeat Steps 2 and 3 until the desired siren tone is achieved then press [OK] to save and exit, or press [MENU] to exit without saving.



Only outputs programmed as event type 36 and or 37 will be affected by this menu option.

System > Siren >

### Volume

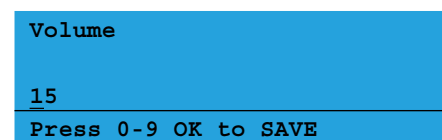
**I-M** MENU 7-4-2

(\*\*\* System Wide Parameter \*\*\*)

1 5

This menu allows you to program the volume level of the radio key speaker beeps which are heard when the system is armed and disarmed using a radio keyfob.

- 1) Press [MENU] + [7] + [4] + [2]. The keypad will display the current siren volume (default = 15).



- 2) Using the numeric keys, enter the new volume level. Valid entries are 0 to 15 where 15 = the loudest volume and 0 = no speaker beeps.
- 3) Press [OK] to save and exit or press [MENU] to exit without saving.



Only outputs programmed as Event Type 36, horn speaker with beeps will be effected by this menu option.

System &gt; Siren &gt;

**Siren Swinger****MENU 7-4-3**

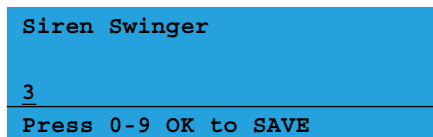
(\*\*\*) System Wide Parameter (\*\*\*)

0 3

This menu allows you to program how many times a zone programmed for Lockout Siren can sound the siren during each arming cycle.

At default, zones programmed for Lockout Siren will be able to trigger the siren 3 times before being locked out. The count will be reset when the system or area is next disarmed.

- 1) Press [MENU] + [7] + [4] + [3]. The keypad will display the current Swinger Siren count.



- 2) Using the numeric keys, enter the new swinger siren count. Valid entries are 0 to 15 where 0 = unlimited.
- 3) Press [OK] to save and exit or press [MENU] to exit without saving.

**TIMEZONES**

The control panel has 2 fixed timezones (Tz0 - Disabled and Tz1 - 24 Hr TimeZone) and 15 programmable timezones.

A timezone is created by setting up a valid time period that becomes TRUE whenever the time is equal to or after the start time and before the end time for the selected day.

There are 2 default timezones created within the system that cannot be changed. These are Tz0 = Disabled - which is FALSE 24/7 and Tz1 = 24 Hour which is TRUE 24/7 (TZ1 being the opposite of Tz0). Tz2 to 16 are configurable to reflect any operation time and day as required to operate, restrict, or control when something happens. Please refer to the following table that illustrates the effect of assigning timezones.

Assigned To Tz0 (Disabled)	Resulting Effect
Door	No access
Door Lock	Will never unlock
Door Group	No access
Egress	Will never trigger
Auto Arming	Will never arm (Same as Tz1)
Output	Will never trigger
Assigned To TZ1 (24 Hr)	Resulting Effect
Door	Full 24 hr access
Door Lock	Unlocked 24 hrs
Door Group	Full 24 hr access
Egress	Operates 24 hrs
Auto Arming	Will never arm (Same as Tz1)
Output	Always triggered

*Table 30: Fixed Timezones (Tz0 & Tz1)*

System > TimeZones >

Name										I-M MENU 7-5-0									
T	i	m	e	Z	o	n	e	2	N	a	m	e							


This menu allows you to program a descriptive text name for each timezone in the system. Each timezone name has up to 20 characters. The timezone name will be referred to in other timezone related programming functions.

- 1) Enter [MENU] + [7] + [5] + [0] and use the up and down arrows to highlight the Schedule in the list then press [OK]. Alternatively, you can enter the Schedule number directly and press [OK].

Tz2 TimeZone 2 Name
Tz3 TimeZone 3 Name
Tz4 TimeZone 4 Name
Press ▲▼ OK or MENU

- 2) Use the arrow and number keys to move and change text. When the Schedule Name is complete, press [OK]. At any time you can press the [OFF] key to clear the text from the current cursor position to the end of the line.

Name Tz3
TimeZone 3 Name
Press ◀▶▲▼ OK to SAVE

 See Alpha Text Programming in Section 4 - Programming Overview for further detail on entering alpha text.

System > TimeZones >

Time										I-M MENU 7-5-1				
Period 1	Start Time			Stop Time										
	--	:	--	:	--	--	:	--	:	--				
	HH		MM		SS	HH		MM		SS				
Period 2	Start Time			Stop Time										
	--	:	--	:	--	--	:	--	:	--				
	HH		MM		SS	HH		MM		SS				
Period 3	Start Time			Stop Time										
	--	:	--	:	--	--	:	--	:	--				
	HH		MM		SS	HH		MM		SS				
Period 4	Start Time			Stop Time										
	--	:	--	:	--	--	:	--	:	--				
	HH		MM		SS	HH		MM		SS				

This menu allows you to program the start time and stop time of each timezone period. Each timezone can have up to 4 different periods.

- 1) Enter [MENU] + [7] + [5] + [1] and use the up and down arrows to highlight the time zone in the list then press [OK]. Alternatively, you can enter the time zone number directly and press [OK].

Tz2 TimeZone 2 Name
Tz3 TimeZone 3 Name
Tz4 TimeZone 4 Name
Press ▲▼ OK or MENU


- 2) Using the arrow keys, select the start/stop period required, then press [OK] to select. Each time zone include 4 separate start/stop periods that can be programmed.

Period 1
Period 2
Period 3
Press ▲▼ OK or MENU

- 3) Enter the start and stop times in 24 hour format. Each include - Hours (HH), Minutes (MM) and Seconds (SS).

Time Tz2 Period 1
Start Time      Stop Time
00:00:00      23:59:59
Press ◀▶▲▼ OK to SAVE

- 4) Press [OK] to save and exit or press [MENU] to exit without saving.

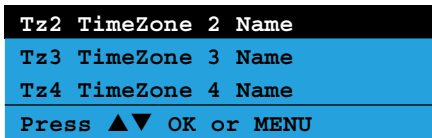
 If the start time equals the stop time then the time zone is disabled. A time of --:--:-- is not used.

System > TimeZones >

Day										I-M MENU 7-5-2
	Sun	Mon	Tue	Wed	Thu	Fri	Sat	Hol		
Period 1	N	N	N	N	N	N	N	N		
Period 2	N	N	N	N	N	N	N	N		
Period 3	N	N	N	N	N	N	N	N		
Period 4		N	N	N	N	N	N	N		

This menu allows you to program which days of the week each period of the time zone will operate. To program, use keys [1] to [8] to toggle on or off the days that the time zone period will operate (e.g. to enable Monday press [2] and to disable Monday press [2] again).

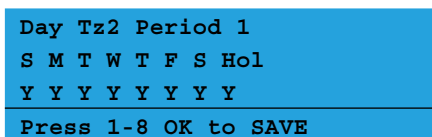
- 1) Enter [MENU] + [7] + [5] + [2] and use the up and down arrows to highlight the time zone in the list then press [OK]. Alternatively, you can enter the time zone number directly and press [OK].



- 2) Using the arrow keys, select the start/stop period required, then press [OK] to select. Each time zone include 4 separate start/stop periods that can be programmed. Each time zone period can have different days of the week programmed.



- 3) Use keys [1] to [8] to enable/disable the days of the week that the time zone period will operate.



- 4) Press [OK] to save and exit or press [MENU] to exit without saving.

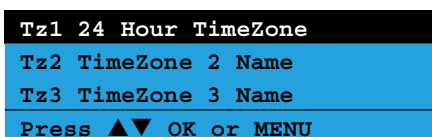
System > TimeZones >

**TimeZone Options** I-M MENU 7-5-3

1	Invert Period Logic	N
2	Reserved	N
3	Reserved	N
4	Reserved	N
5	Reserved	N
6	Reserved	N
7	Reserved	N
8	Reserved	N

This menu allows you to program what function the time zone will perform. There are a number of options which are explained in more detail below.

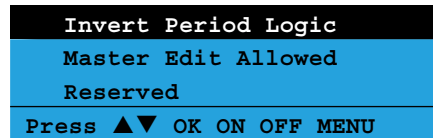
- 1) Enter [MENU] + [7] + [5] + [3] and use the up and down arrows to highlight the time zone in the list then press [OK]. Alternatively, you can enter the time zone number directly and press [OK].



- 2) Using the arrow keys, select the start/stop period required, then press [OK] to select. Each time zone include 4 separate start/stop periods that can be programmed.



- 3) Use the up and down arrow keys to highlight the option then press the [ON] key to enable or the [OFF] key to disable. Repeat Step 2 until all options are programmed as required.



- 4) Press [OK] to save and exit or press [MENU] to exit without saving.

**Invert Logic**

Setting this option will invert both the start time and stop time of the period of the selected time zone. The programmed start time will now be the stop time and the programmed stop time will be the start time.

**Master Can Edit**

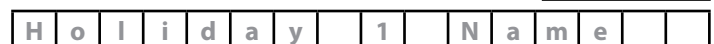
Setting this option allows a master user to edit the timezone period. There are many instances where altering a timezone can seriously alter the behaviour of the system and only trained professional operators should be allowed to perform this type of operation.

**SYSTEM HOLIDAYS**

The control panel has provision for up to 8 individual holiday time periods which can be used to allow or deny access to users or to operate outputs via timezones. Holidays are defined by setting a start and stop date so it is possible to create 1 system holiday that spans multiple days. For example the holiday could start on the 1st Jan and end on the 5th Jan.

System > Holidays >

**Holiday Name** I-M MENU 7-6-0



This menu allows you to program a 20 character text name for each holiday.

- 1) Enter [MENU] + [7] + [6] + [0] and use the up and down arrows to highlight the Holiday in the list then press [OK]. Alternatively, you can enter the Holiday number directly and press [OK].



```

H1 Holiday 1 Name
H2 Holiday 2 Name
H3 Holiday 3 Name
Press ▲▼ OK or MENU

```

- Use the arrow and number keys to move and change text. When the Holiday Name is complete, press [OK]. At any time you can press the [OFF] key to clear the text from the current cursor position to the end of the line.

```

Holiday Name H1
Holiday 1 Name
Press ◀▶▲▼ OK to SAVE

```

System > Holidays >

Start Stop Dates I-M MENU 7-6-1

```

Start 12am          Stop 12am
01 Jan            01 Jan
DD MM             DD MM

```

This menu allows you to program the start and stop date for each holiday period. Holidays can be as short as one day or as long as 364 days.

- Enter [MENU] + [7] + [6] + [1] and use the up and down arrows to highlight the Holiday in the list then press [OK]. Alternatively, you can enter the Holiday number directly and press [OK].
- Use the up and down arrow keys to select the holiday that you want to change, then press [OK]. Alternatively, you can enter the holiday number, then press [OK]. The keypad will display the holiday start date:

```

Holiday Dates H1
Start 12am Stop 12am
01 Jan      01 Jan
Press ◀▶▲▼ OK to SAVE

```

- To program, use the left and right arrows to scroll the cursor left and right between the holiday day and month options and use the up and down arrow keys to scroll the day and month.
- Press [OK] to save and exit or press [MENU] to exit without saving.



*If the start day and month equals the stop day and month then no holiday exists. There must be a difference between start and stop dates.*

## SYSTEM OPTIONS

System > System Options >

General Options I MENU 7-7-0

1	Display LAN Fail	Y
2	Report LAN Fail	Y
3	Alarm On LAN Fail	N
4	Cannot Change Own PIN	N
5	Reserved	N
6	Monitor Default PINs	Y
7	PIN Always Required	N
8	Display Menu Numbers	Y

(\*\*\* System Wide Parameter \*\*\*)

This menu allows you to configure the General system options. All options are global to users, areas and keypads.

- Press [MENU] + [7] + [7] + [0]. The keypad will display the current General system options.

```

✓ Display LAN Fail
✓ Report LAN Fail
  Alarm On LAN Fail
Press ▲▼ OK ON OFF MENU

```

- Use the up and down arrow keys to highlight the option then press the [ON] key to enable or the [OFF] key to disable. Repeat Step 2 until all options are programmed as required.
- Press [OK] to save and exit or press [MENU] to exit without saving.

### Display LAN Fail

Setting this option allows all connected keypads to display a system trouble when a device connected the the system LAN has failed to communicate to the panel.

### Report LAN Fail

Setting this option allows the panel to report which LAN device has failed to the base station.

### Alarm On LAN Fail

Setting this option allows the panel to sound an alarm when a device connected to the LAN failed to communicate to the panel.

### Cannot Change Own PIN

Setting this option prevents all users the ability to change their own PIN.

### Monitor Default PINs

Setting this option will cause the panel to monitor the default Installer PIN and User 1 PIN which are factory set to 1234 and 2580 respectively. If either of these codes are left as default then the keypad will display the system trouble Default PIN. The fault will clear once the code or codes have been changed.

## PIN Always Required

Setting this option will force the system to request a valid PIN to be entered before any menu functions can be accessed. If this option is not set then some restricted menu options will be available without entering a valid PIN.

## Display Menu Numbers

Setting this option causes the keypad to display the menu numbers for all commands and menu programming options. The menu numbers can be used as navigation shortcuts when programming.

System > System Options >

### Area Options

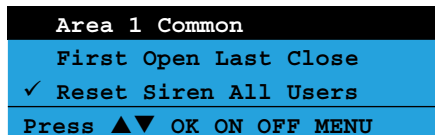
**1** MENU 7-7-1

1	Area 1 Common	N
2	First Open Last Close	N
3	Reset Siren All Users	Y
4	Power Up As Down	Y
5	Fault ACK All Areas	Y
6	Delay Trouble Beeps	Y
7	Power Up Disarmed	N
8	Reserved	N

(\*\*\* System Wide Parameter \*\*\*)

This menu allows you to configure the Area system options. All options are global to users, areas and keypads.

- 1) Press [MENU] + [7] + [7] + [1]. The keypad will display the current Area system options.



- 2) Use the up and down arrow keys to highlight the option then press the [ON] key to enable or the [OFF] key to disable.
- 3) Repeat Step 2 until all options are programmed as required, then press [OK] to save and exit or press [MENU] to exit without saving.

## Area 1 Common

Setting this option will cause the system to automatically arm Area 1 All On when all other areas have been turned on. As soon as any area is turned off the system will automatically turn Area 1 off. Only one common area is available on the system. If no common area is required then do not set this option.

## First Open Last Close

Setting this option will cause the system to only report an opening signal to the base station when the first area is Disarmed and a closing signal when the last area has been armed or turned All On.

## Reset Siren All Users

Setting this option allows a user with a valid PIN to silence alarm outputs from any keypad on the system without the need to toggle the keypad to the area that the alarm occurred.

If this option has not been programmed, the user will need to toggle the keypad to the area the alarm occurred in and then silence the alarm by entering their PIN followed by the [OFF] key.

## Power Up As Down

Setting this option will cause the panel to power up in the same state as it was when it was powered down. For example with this option set if the panel is in the disarmed state and all power is removed for service work to be done. When the power is reapplied, the panel will start in the disarmed state. Any zone that was programmed as bypassed when the power was removed will remain bypassed when the power supply has restored.

If this option is not programmed, the system will always power up in the armed All On state and any zones bypassed prior to power loss will power up as un-bypassed zones.

## Fault ACK All Areas

Setting this option allow system trouble faults to be acknowledged from any area or keypad on the system without the need to toggle over to the area the fault occurred in.

## Delay Trouble Beeps

Setting this option will prevent any system trouble events from sounding the keypad speaker between the hours of 10pm until 7am. During this time, any new trouble events will be shown in the keypad display.

If any trouble events are still in effect at 7am, the keypad will begin sounding the trouble alert to notify the user of the problem. The function is primarily for use in residential installations.

## Power Up Disarmed

Setting this option will allow the control panel to always power up in the disarmed state after removing both the battery and AC mains supply and then reapplying power.

System &gt; System Options &gt;

**Keypad Idle Screen****I** MENU 7-7-2

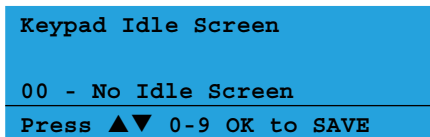
(\*\*\*) System Wide Parameter (\*\*\*) | | | 0 0

00 - No Idle Screen      02 - Time  
01 - Date And Time      03 - Custom Screen

This menu allows you to select a keypad Idle Screen which will appear on the display when there has been no activity at the keypad for a period of 2 minutes. The keypad display will return to normal as soon as any key has been pressed.

All keypads on the system will display the same screen saver. See the examples below.

- 1) Press [MENU] + [7] + [7] + [2]. The keypad will display the current Keypad Idle Screen option.



- 2) Use the up and down arrow keys to select which idle screen you want to display then press [OK] to save and exit or press [MENU] to exit without saving.

System &gt; System Options &gt;

**Keypad Hi/Lo Temp****I-M** MENU 7-7-3

0 0 0 °C      0 0 0 °C  
Hi TEMP      Lo TEMP

(\*\*\*) System Wide Parameter (\*\*\*)

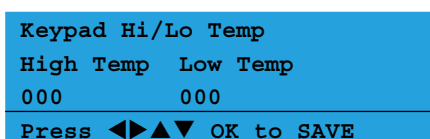
This menu allows you to set the keypad High and Low temperature values which the system will monitor. Valid temperatures are from 00 °C minimum to a maximum of 50 °C with a tolerance = +/- 1 °C.

If the temperature on the selected keypad falls below the minimum set temperature then the keypad will display 'Low Temp xx°C'. If the temperature increases above the maximum set temperature then the keypad will display High temp xx°C.

Where xx = the set temperature to be monitored.

(\*\*\*) System Wide Parameter (\*\*\*)

- 1) Press [MENU] + [7] + [7] + [3]. The keypad will display the current temperature settings.



- 2) Use the up and down arrow keys to program the High and Low temperatures. Use the left and right arrow keys to move between the High and Low temperatures. Valid range = ( 000 °C to 050 °C).
- 3) Press [OK] to save and exit or press [MENU] to exit without saving.

System &gt; System Options &gt;

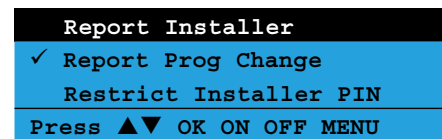
**Installer Options****I** MENU 7-7-4

1	Report Installer	N
2	Report Prog Change	Y
3	Restrict Installer PIN	N
4	Reserved	N
5	Auto Exit Install 2hr	Y
6	Auto Exit Service 2hr	Y
7	Multi Tenant Mode	N
8	Allow Defaulting	Y

(\*\*\*) System Wide Parameter (\*\*\*)

This menu allows you to configure the Installer system options.

- 1) Press [MENU] + [7] + [7] + [4]. The keypad will display the current Installer options.



- 2) Use the up and down arrow keys to highlight the option then press the [ON] key to enable or the [OFF] key to disable.
- 3) Repeat Step 2 until all options are programmed as required, then press [OK] to save and exit or press [MENU] to exit without saving.

**Report Installer**

Setting this option will cause the panel to make a log entry and to send a report to the base station when the installer enters and exits Installer programming mode. The entry/exit reports will follow the System Route.

**Report Prog Change**

Setting this option will cause the panel to make a log entry and to send a report to the base station when the installer has changed programming data. The data changed reports will follow the System Route.

**Restrict Installer PIN**

After power up, the installer PIN can turn on or off an area (or multiple areas if partitioned) until a user PIN is used to turn an area on or off. If the system is in service mode, then the installer PIN can always silence and turn off an area when an alarm even occurs.

### Auto Exit Install 2hr

Setting this option will cause the panel to automatically terminate Installer programming mode after 2 minutes of no activity on the keypad. If this option is not set, the panel will remain in Installer programming mode until manually terminated.

### Auto Exit Service 2hr

Setting this option will cause the panel to automatically terminate service mode after 2 hours of no activity on the keypad keys. If this option is not set, the panel will remain in the service mode until it is manually terminated.

### Multi Tenant Mode

This options includes additional support for muti tenant applications such as self storage garages or scholl storage lockers etc.

When enabled, the option will lock the first 144 users on the system to each of the 144 zones on the system. Each time the users enters their PIN + [OFF], the corresponding zone is automatically bypassed allowing them to access the zone area. The zone is again ready to detect intrusion when the user enters their PIN + [ON].

Users 145 to 255 continue to operate as normal users.

### Allow Defaulting

Setting this option will allow the panel to be defaulted back to the factory setting using the the on board push button switch. See below for defaulting instructions.

If this option is not set then manual defaulting will not function and the only way to default the panel will be by using the current installer PIN. If the installer PIN is not know then the panel will need to be returned to Bosch Security for defaulting. A charge applies for this service.



*Defaulting the panel does not erase all events in the history event log. If this option has been disabled, the dialler seize relay will pulse or click 4 times during power up.*

System > System Options >

### Language

**I** MENU 7-7-5

- 0 - English
- 1 - Alternate Language

0

This menu allows you to select the language that will be displayed on the keypad. You have a choice between English (default) or a second language (determined by the country that the control panel is shipped to).

- 1) Enter [MENU] + [7] + [7] + [5]. The keypad will display the following:

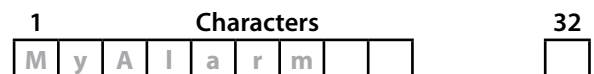


- 2) Using the numeric keys, enter the language option as required then press [OK] to save and exit or press [MENU] to exit without saving.

System > System Options >

### Site Name

**I-M** MENU 7-7-7



This menu allows the master user to program the emails subject line to identify the alarm system (eg. site name) to the receiving party. A maximum of 32 characters of text can be entered in this field. Use the [←] and [→] keys to scroll the cursor left and right to view the entire name.

- 1) Enter [7] + [7] + [7] + [OK].  
The keypad will display the current Site Name.



- 2) Using the numeric keys, enter the description of the control panels site name. You can change a single chanracter by scrolling the cursor left [←] and right [→].

At any time you can use the [↑] and [↓] keys to scroll through the complete list of available characters.

To clear all text from the cursor position to the right, press the [OFF] key.

- 3) When the site name is complete, press [OK] to save and exit, or press [MENU] to exit without saving.

**SYSTEM TESTING**

System &gt; System Testing &gt;

**Walk Test All Zones****I - M - U****MENU 7-9-0**

This menu allows you to test all zones within an area at the same time.

- 1) Press [MENU] + [7] + [9] + [0]. The keypad will display a list of areas that are available to walk test zones.
- 2) Using the up and down arrow keys, select the area that you want to walk test, then press [OK]. Alternatively, you can enter the area number, then press [OK]. The keypad will begin to scroll all zones that need to be tested.

```
To test Zn1
open then close
Zone 1 Name
-----
Press OK or MENU
```

- 3) Open and close each zone that needs to be tested. A zone that has been successfully tested will no longer scroll on the keypad display. When all zones have been tested, the keypad will display.

```
All zones have been
successfully tested
-----
Press OK or MENU
```

- 4) Press [OK] to save and exit or press [MENU] to exit without saving.

System &gt; System Testing &gt;

**Battery Test****I - M - U****MENU 7-9-1**

This menu allows you to test the panels standby battery. The battery test will last about two minutes and the keypad will display the voltage of the battery during the test.

- 1) Press [MENU] + [7] + [9] + [1]. The keypad will display the battery voltage whilst under test:

```
Battery test in progress.
Please wait..
Voltage = 13.4V
-----
To Go Back Press OK
```

If the battery has passed the test, the keypad will display:

```
Battery Test Passed
Press OK To Continue
-----
To Go Back Press OK
```

If the battery has failed the test, the keypad will display:

```
Battery Test Failed
Please Call For Service
-----
To Go Back Press OK
```

- 2) Press [OK] to exit.

» » E N D O F S E C T I O N « «

**This page left intentionally blank**



# Programming Examples

This section includes a number of programming examples detailing how to implement some common installation functionality.

Examples are provided to show;

- ❖ How to Open a Garage Door using a Single Digit Code.
- ❖ How to Open a Garage Door using a 4 Button Keyfob.
- ❖ How to set Auto Arming for an Area.
- ❖ How to operate an Output using a Schedule
- ❖ How to Use a Reader to Unlock a Door.
- ❖ How to Use a Reader to Unlock a Door and Disarm Area 1.
- ❖ How to Use a Reader to Unlock a Door and Arm/Disarm.
- ❖ How to use Call Line Identification.
- ❖ How to send SMS Reports.

## Opening a Door using a Single Digit Code

The control panel can be used to operate an electrically controlled door using a single digit code. The example assumes User 10 and Output 5 are being used. (Output 5 is located on the CM710B Output Expander).

### Procedure

- 1) Set user PIN Length in MENU 1-5-0 = 00 (00 = Variable)
- 2) Set user 10 PIN in MENU 1-1-2 = 5
- 3) Set user 10 Area Assignment in MENU 1-4-1 = 0
- 4) Set Output 5 - Event Type in MENU 4-1-1 = 56 (56 = Follow Pin)
- 5) Set Output 5 - Event Assignment in MENU 4-1-2 = 10 (10 = User Number)
- 6) Set Output 5 - Output Polarity in MENU 4-1-3 = 04 (04 = Open 1 Shot Low)
- 7) Set Output 5 - Time Parameter MENU 4-1-4 = 000 000 005 000 (5 seconds)
- 8) Enable Output 5 - Output Options MENU 4-1-5 = Display Status Message

Wire Output 5 to the appropriate Door Controller input. Each time button [5] + [OK] on the keypad is pressed the door will activate.

## Opening a Garage Door Using a 4 Button RF Keyfob

The following example show how to configure the control panel to allow control of a grage door as well as arm and disarm functions using a 4 Button Keyfob. The example assumes User 10 and Output 5 are being used. (Output 5 is located on the CM710B Output Expander).

### Procedure

- 1) Set RF Receiver Type in MENU 3-5-0 = 04 - Bosch Serial Rcvr
- 2) Assign Keyfob to User 10 in MENU 1-3-0
- 3) Set Output 5 - Event Type in MENU 4-1-1 = 54 (54 = RF Keyfob Function 2)
- 4) Set Output 5 - Event Assignment in MENU 4-1-2 = 01 (01 = Security System)
- 5) Set Output 5 - Output Polarity in MENU 4-1-3 = 4 (04 = Open 1 Shot Low)
- 6) Set Output 5 - Time Parameter in MENU 4-1-4 = 000 000 005 000 (5 seconds)
- 7) Enable Output 5 - Output Options in MENU 4-1-5 = Display Status Message.

## Auto Arming an Area

The control panel can be configured to automatically arm and or disarm an area automatically if required.

### Procedure

To setup an Auto Arming time, select a timezone that is not being used, and program the timezone name in MENU 7-5-0 to something convenient.

Set the timezone period start time in MENU 7-5-1 for the arming time you require. The stop time should be set to 12:00am or --:--am, which prevents the system from auto disarming.

Set the timezone period day in MENU 7-5-2 for the days of the week you require the area to automatically arm.

Set the timezone that you want the area to follow in MENU 2-1-8.

**Operating an Output with a TimeZone**

To automatically operate an output using a timezone, select an timezone that is not being used, and program the timezone name in MENU 7-5-0 to something convenient. Set the timezone period start time in MENU 7-5-1 to the time you want the output to operate and set the stop time to the time you want the output to turn off. Set the timezone period day in MENU 7-5-2 for the days of the week that you want the output to operate on. Set the Event Type as 58 - TimeZone for the output that you want the timezone to operate in MENU 4-1-1. Set the output Event Assignment to follow the timezone you want the output to follow in MENU 4-1-2. Program the Output Polarity in MENU 4-1-3 as 00 - Open To Low or 07 - Low To Open as required.

**Unlock a Door using a LAN Reader**

This example assumes LAN Reader 9, Door Assignment 4, User 1 and Output 5 are being used.

**Procedure**

- 1) Assign LAN Reader 9 to Door Assignment 4 in MENU 6-1-7.
- 2) Set output 5 to Event type to 60 - Door in MENU 4-1-1 and the output Door Assignment to 4 in MENU 4-1-2. Set the output Polarity in MENU 4-1-3 and the output Time Parameter in MENU 4-1-4 as required.
- 3) Assign the user to Door 4 in MENU 1-4-5. Users can belong to multiple doors.
- 4) Assign the LAN Reader Home Area to 0 (All Areas) in MENU 6-1-3 and then disable Options 1, 2, 3 & 4 in MENU 6-1-2.
- 5) Program the Door Assignment for User 1 in MENU 1-4-5 as 4.
- 6) Add a token to User 4 in MENU 1-2-0.
- 7) Exit programming mode and present the token to the LAN reader to access the door.

**Unlock a Door and Disarm Area 1 using a LAN Reader**

This example assumes LAN Reader 9, Door Assignment 4, User 1 and Output 5 are being used.

**Procedure**

- 1) Assign LAN Reader 9 to Door Assignment 4 in MENU 6-1-7.
- 2) Set output 5 to Event type to 60 - Door in MENU 4-1-1 and the output Door Assignment to 4 in MENU 4-1-2. Set the output Polarity in MENU 4-1-3 and the output Time Parameter in MENU 4-1-4 as required.
- 3) Assign the user to Door 4 in MENU 1-4-5. Users can belong to multiple doors.
- 4) Assign the LAN Reader Home Area to 1 (Area 1) in MENU 6-1-3 and then disable Options 1, 2 & 4 in MENU 6-1-2.

- 5) Program the Door Assignment for User 1 in MENU 1-4-5 as 4.
- 6) Add a token to User 4 in MENU 1-2-0.
- 7) Exit programming mode and present the token to the LAN reader to access the door.

**Unlock a Door and Arm/Disarm Area 1 using a LAN Reader**

This example assumes LAN Reader 9, Door Assignment 4, User 1 and Output 5 are being used.

**Procedure**

- 1) Assign LAN Reader 9 to Door Assignment 4 in MENU 6-1-7.
- 2) Set output 5 to Event type to 60 - Door in MENU 4-1-1 and the output Door Assignment to 4 in MENU 4-1-2. Set the output Polarity in MENU 4-1-3 and the output Time Parameter in MENU 4-1-4 as required.
- 3) Assign the user to Door 4 in MENU 1-4-5. Users can belong to multiple doors.
- 4) Assign the LAN Reader Home Area to 1 (Area 1) in MENU 6-1-3 and then disable Options 2 & 4 in MENU 6-1-2.
- 5) Program the Door Assignment for User 1 in MENU 1-4-5 as 4.
- 6) Add a token to User 4 in MENU 1-2-0.
- 7) Exit programming mode and present the token to the LAN reader to access the door.



### **Using CLI to establish Upload/Download Connection**

Calling Number Identification is a feature provided by your teleco line provider that can help you identify who is calling by displaying the caller's phone number.

This feature is used by the control panel to identify the telephone number that the upload download computer is calling from. When the control panel verifies that the calling number corresponds to any one of the three different numbers programmed in MENU 5-3-7 — CLI Number then the panel will answer the call immediately.

This feature is extremely helpful for remote access using the Solution Link software to eliminate the need for making multiple calls to fax bypass or annoying customer calls where you have to let the number ring numerous times to trigger the panel into answering your call.

The numbers you store into MENU 5-3-7 should include the full STD number of the calling line you which the panel to answer on.

Almost every telephone line will send its CLI information when making a call however you will not receive the callers line information if you don't specifically request and enable this feature with your telco line provider.

### **Sending SMS Alarm Reports**

The control panel is capable of reporting alarm information directly to a mobile phone using SMS messaging without the need to add any additional hardware.

#### Procedure

- 1) **Determine the required reporting destination and set the reporting format to SMS.**
- 2) **When setting the control panel to report via SMS in destination 1 and/or destination 2, the control panel has been predefined to use the MyAlarm Gateway telephone numbers in MENU 5-5-7 (SMS Primary = 183213450641 / SMS secondary = 18321341825).**
- 3) **Program the mobile phone number that the messages are to be sent to into MENU 5-1-1 (Destination 1) and/or MENU 5-1-2 (Destination 2). You can send an SMS message to 5 different mobile telephone numbers per destination for each reporting event.**
- 4) **Program the destination route for each event type which is required to report to SMS. By default all event types report to Destination 1.**

**» » END OF SECTION « «**

**This page left intentionally blank**



# Specifications

## Specifications

### Electrical

#### Voltage Input

- 16 - 22 VAC

#### Current Requirement

- 22 VA min plug pack adapter or transformer

#### Panel Current Consumption

- 110 ma standby

### Power Outputs

#### Continuous Power

- 1 Amp (Primary supply source only)

#### Secondary Source

- 5 Amp (Total with both primary and secondary source combined)

#### Stand-By Battery

- 12 VDC, 7AH sealed rechargeable battery

#### Min Operating Voltage

- 10.2 VDC

### LAN BUS

- Max total LAN length using multi strand security cable = 300m.
- Max total LAN length using 2 pair twisted shielded data cable (Belden 8723) = 1200m.

### Telephone Connection

RJ-12 Socket or 4-way terminal.

### Temperature

0° to 55°C.

### Relative Humidity

5 to 85% at 30°C non-condensing.

### Enclosure Dimensions

MW720 - 385mm (W), 260mm (H), 90mm (D)

MW730 - 385mm (W), 520mm (H), 90mm (D)

### PCB Dimensions

235mm (W), 40mm (H), 85mm (D)

### Warranty

3 years from date of manufacture

## Approvals

- ◆ EN 55022:2006
- ◆ AS/NZS CISPR 22:2006
- ◆ EN 60950-1:2001 Amdt 11:2004
- ◆ AS/NZS 60950.1:2003 Amdt 1:2006
- ◆ AS/ACIF S002:2005
- ◆ PTC200 May 2006
- ◆ ETSI TS 103 021-1, 2 & 3

## Compatible Keypads

- ◆ CP050B - Night Arm Station
- ◆ CP150B - External Vandal Resistant Keypad
- ◆ CP151B - External Vandal Resistant Keypad
- ◆ CP700B - Graphic (White)
- ◆ CP701B - Graphic + Prox (White)
- ◆ CP710B - Graphic (Black)
- ◆ CP711B - Graphic + Prox (Black)
- ◆ PR109B - Internal LAN Prox Reader (Black)
- ◆ PR110B - Internal LAN Prox Reader (White)
- ◆ PR111B - External LAN Prox Reader (Black)
- ◆ PR112B - External LAN Prox Reader (White)

## Expansion Devices

- ◆ CM101B - Voice Module
- ◆ CM195B - Multi RF Receiver Interface
- ◆ CM401B - LAN Translator (BPT Intercom)
- ◆ CM704B - 8/16 Zone Input Expander
- ◆ CM705B - Universal Expansion Module
- ◆ CM707B - 8/16 Piggy Back Zone Input Expander Module
- ◆ CM710 B- 4-Way Relay Output Module
- ◆ CM720 B- 1 Amp Power Supply Module
- ◆ CM728B - Bio Metric Reader (Black)
- ◆ CM729B - Bio Metric Reader (White)
- ◆ CM743B - GSM/GPRS 2G Plug On Module
- ◆ CM744B - GSM/GPRS 3G Plug On Module
- ◆ CM750B - TCP/IP Interface Module
- ◆ CM751B - TCP/IP Interface Module
- ◆ CM752B - Plug On WiFi Module
- ◆ CM760B - Real Time Clock Module
- ◆ CM797B - LAN Isolator Module

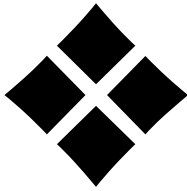
**Accessories**

- ◆ SW500B - SolutionLink Software
- ◆ CM900 - Direct Link Cable
- ◆ CM901 - Flash Upgrade Cable
- ◆ CM255 - Default Key
- ◆ MACC600BI - Solution 144 Installation Manual

**The following parts are supplied with the panel**

(Australian models only - content may differ in export models )

Panel Assembly Includes	1 x Metal Enclosure with tamper 1 x Panel PWA 1 x User Manual	1 x Installer Reference Guide 1 x Resistor Pack
Resistor Pack Includes	1 x Red Battery Lead 1 x Black Battery Lead 1 x 2-Way Shunt With Handle 2 x Phillips Pan Head Zinc Plate Screw 1 x Telephone Cable RJ12 6P/4C 10 x 3K3 – 0.25W +/- 1% Metal Film Resistors 10 x 6K8 – 0.25W +/- 1% Metal Film Resistors 1 x 3-Way AC Terminal Block 1 x Panel Tamper Switch 1 x Tamper Switch Bracket	



<b>A</b>	
<b>ACCESS</b>	
Options .....	5-11
Programming.....	5-1
Route .....	5-11
<b>Account #</b>	
Destination 1 .....	6-8
Destination 2 .....	6-8
<b>AC Options</b>	
Delay Fail To 1 Hour .....	11-7
Display Clock Trouble .....	11-7
Display Fail .....	11-7
Random Delay Reports.....	11-7
Report Fail.....	11-7
Sync System Clock .....	11-7
<b>Alarm On LAN Fail .....</b>	<b>11-13</b>
<b>Alarm, PIN Retry Exceed Limit .....</b>	<b>6-5</b>
<b>Alpha Text Programming.....</b>	<b>4-2</b>
<b>Answering Machine Bypass .....</b>	<b>9-11</b>
<b>Area Programming.....</b>	<b>6-1</b>
<b>AREAS</b>	
Area Name .....	6-3
Area Status .....	6-1
Area Watch .....	6-11
Auto Arming.....	6-7
Chime Mode.....	6-3
Chime On/Off.....	6-2
Description .....	1-1
Disarming An Area .....	4-10
Exit Time Restart .....	6-4
General Options .....	6-3
Input Options.....	6-4
Move To Area .....	6-2
Output Options.....	6-5
Part Mode 1 Name .....	6-7
Part Mode 2 Name .....	6-7
Reporting Options .....	6-5
Senior Watch .....	6-5
Strobe Trigger .....	6-6
Test Options .....	6-12
Turn All Areas Off .....	6-2
Turn All Areas On .....	6-2
Turn Area On/Off .....	6-2
<b>Arming.....</b>	<b>4-10</b>
<b>Auto Arm Pre-Alert .....</b>	<b>6-10</b>
<b>Auto Exit Installer Menu In 2 Min .....</b>	<b>11-15</b>
<b>Auto Exit Service Mode In 2 Hrs.....</b>	<b>11-16</b>
<b>Automatic Arming .....</b>	<b>4-10</b>
<b>B</b>	
<b>Basic Operations</b>	
Automatic Arming .....	4-10
Duress Alarm .....	4-11
Remote Arming - Quick Arm .....	4-11
Turning An Area All On.....	4-10
Turning An Area Off.....	4-10
Turning An Area Part On/Part 2 On .....	4-10
<b>BASIC REPORTING REFERENCE.....</b>	<b>4-5</b>
<b>Battery Options</b>	
Display Fail .....	11-8
Execute Test On Arm .....	11-8
OK To Arm Low Battery.....	11-8
Report Fail.....	11-8
<b>Battery Test.....</b>	<b>11-17</b>
<b>Burg Report Delay .....</b>	<b>9-15</b>
<b>Bypass Allowed.....</b>	<b>7-11</b>
<b>C</b>	
<b>Call / Answer RAS .....</b>	<b>9-1</b>
<b>Call Attempt Count .....</b>	<b>9-6</b>
<b>Call Back Number.....</b>	<b>9-9</b>
<b>Call Back Verification Required .....</b>	<b>9-11</b>
<b>Call Forward Off .....</b>	<b>9-6</b>
<b>Call Forward On .....</b>	<b>9-5</b>
<b>Cancel Reports .....</b>	<b>6-6</b>
<b>Cannot Change Own PIN .....</b>	<b>11-13</b>
<b>CHIME</b>	
Mode.....	6-3
Tone 10-6	
Turn On/Off .....	6-2
Zones .....	7-3
<b>CLI Number .....</b>	<b>9-13</b>
<b>Clock Programming.....</b>	<b>4-2, 11-6</b>
<b>Command Menus.....</b>	<b>4-1</b>
<b>Common Area</b>	
Area 1 = Common Area .....	11-14
Link To Common Area.....	6-4
<b>Comms Programming.....</b>	<b>9-1</b>
<b>Control Panel</b>	
Dialler LED.....	2-5
Status LED.....	2-5
<b>Country .....</b>	<b>9-8</b>
<b>D</b>	
<b>Data Changed Report .....</b>	<b>11-15</b>
<b>Date &amp; Time .....</b>	<b>11-6</b>
<b>Daylight Saving</b>	
Australian Daylight Savings Times .....	11-6
Summertime Off.....	11-6
Summertime On.....	11-6
<b>Template Default .....</b>	<b>11-5</b>

**DEFAULTING THE SYSTEM**

Domestic Defaults .....	4-3
Factory Defaulting Allowed .....	11-16
Hardware Default .....	4-3
Software Default .....	4-3
<b>Delay Report</b> .....	<b>7-10</b>
<b>Delay Trouble Beeps</b> .....	<b>11-14</b>
<b>Delete PIN</b> .....	<b>5-4</b>
<b>Destination 1</b>	
Account # .....	6-8
Telephone Numbers .....	9-4
TX Format .....	9-14
<b>Destination 2</b>	
Account # .....	6-8
Telephone Numbers .....	9-5
TX Format .....	9-14
<b>Device Status</b> .....	<b>10-1</b>
<b>Dialler Enabled</b> .....	<b>9-7</b>
<b>Dialler Options</b> .....	<b>9-7</b>
<b>Dial Number Test</b> .....	<b>9-26</b>
<b>DIRECT LINK</b>	
Programming .....	4-3
Start Session .....	9-2
<b>Disarming</b> .....	<b>4-10</b>
<b>Display LAN Fail</b> .....	<b>11-13</b>
<b>Display Menu Numbers</b> .....	<b>11-14</b>
<b>Domestic Default</b> .....	<b>4-3, 11-4</b>
<b>DOOR</b>	
Array .....	4-4, 8-3
Name .....	8-12
Options .....	8-13
Override .....	8-3
Status .....	8-2
Unlock TimeZone .....	8-12
<b>DTMF Control Functions</b> .....	<b>4-6, 9-12</b>
<b>DTMF Options</b> .....	<b>9-11</b>
<b>Duress Alarm</b> .....	<b>4-3, 4-11</b>
<b>Duress Allowed</b> .....	<b>6-4</b>

**E**

<b>Email Address</b> .....	<b>9-17</b>
<b>Emergency Route</b> .....	<b>9-15</b>
<b>Entry Time 1</b> .....	<b>6-9</b>
<b>Entry Time 2</b> .....	<b>6-9</b>
<b>EOL Value</b> .....	<b>7-12</b>
<b>Erase User</b> .....	<b>5-2</b>
<b>ETHERNET MODULE</b>	
Default Gateway .....	10-14
IP Address .....	10-14
MAC Address .....	10-14
Options .....	10-14
Subnet Mask .....	10-14
<b>Event Type</b> .....	<b>8-4</b>
<b>Exit Error Alarm</b> .....	<b>6-5</b>
<b>Exit Error Report</b> .....	<b>6-6</b>
<b>Exit Time</b> .....	<b>6-8</b>
<b>Exit Time Restart</b> .....	<b>6-4</b>

**F**

<b>Factory Default</b> .....	<b>11-4</b>
Allowed .....	11-16
<b>Fault Acknowledge All Areas</b> .....	<b>11-14</b>
<b>Fault ACK Required</b> .....	<b>6-4</b>
<b>Features</b> .....	<b>1-1</b>
<b>Fingerprint</b>	

<b>Add</b> .....	<b>5-12</b>
<b>Delete</b> .....	<b>5-12</b>
<b>Status</b> .....	<b>5-12</b>
<b>Fire Alarm</b> .....	<b>6-6</b>
<b>Fire Report Delay</b> .....	<b>9-15</b>
<b>First To Open / Last To Close</b> .....	<b>11-14</b>
<b>Fuse Options</b>	
Display +12V Overload .....	11-8
Display COMM+ Overload .....	11-8
Display LAN+ Overload .....	11-9
Report +12V Overload .....	11-9
Report COMM+ Overload .....	11-8
Report LAN+ Overload .....	11-9

**G**

<b>GSM/GPRS Module</b>	
Options .....	10-12
SMS Control Numbers .....	10-13
Status .....	10-11
Trigger Table 1 Numbers .....	10-12
Trigger Table 2 Numbers .....	10-13

**H**

<b>Handover</b>	
Non Sequential Handover .....	6-4
Pulse Count Handover Allowed .....	6-4
<b>History Log</b> .....	<b>11-3</b>
Threshold .....	9-10
<b>Holidays</b>	
Name .....	11-12
Start Stop Dates .....	11-13
<b>Home Area</b> .....	<b>10-4</b>
<b>Horn Speaker</b>	
RF Beep Volume .....	11-9
Speed .....	11-9
Tone .....	11-9

**I**

<b>Input Options</b> .....	<b>7-13</b>
<b>Installer Menu Log</b> .....	<b>11-15</b>
<b>Installer Options</b>	
Auto Exit Install 2hr .....	11-15
Auto Exit Service 2hr .....	11-15
Defaulting Allowed .....	11-15
Multi Tenant Mode .....	11-15
Report Data Change .....	11-15
Report Installer .....	11-15
Restrict Installer PIN .....	11-15
<b>Installer PIN</b>	
Arm Only .....	11-15
Change PIN .....	5-11
Enter Programming Mode .....	4-1
<b>Installing</b>	
Connecting Battery .....	2-4
Connecting Power .....	2-4
Enclosure .....	2-1
EOL Resistor Colour Code .....	2-8
Optional MAINS Transformer .....	2-4
Panels & Modules .....	2-2
PCB Connectors .....	3-2
PCB LED Indicators .....	2-5
Tamper Switch .....	2-1
Terminal Descriptions .....	3-2
<b>Inverted Seal</b> .....	<b>7-10</b>

**IP Remote Access**

IP Address .....	9-22
IP Port .....	9-22
IP RAS Options .....	9-23
IPRS Address .....	9-24
IPRS Port .....	9-24
RAS Lockout Time .....	9-23

**IP Reporting**

ACK Wait Time .....	9-19
Conettix NNC .....	9-20
Encryption Key .....	9-20
IP Format .....	9-19
Poll Rate .....	9-19
Receiver IP .....	9-18
Receiver Port .....	9-18
Retry Count .....	9-20
SIA Prefix .....	9-21
Username & Password .....	9-21

**K****KEYFOBS**

Arm/Disarm Strobe Flash .....	6-6
Add Keyfob .....	5-6
Delete Keyfob .....	5-6
Test Keyfob .....	5-6

**Keypad**

Icon Descriptions .....	2-6
LED Descriptions .....	2-6

**KEYPAD**

Backlight .....	10-2
Contrast .....	10-2
Emergency Keys .....	10-7
Idle Screen .....	11-15
Set Hi/Lo Temperature .....	11-15
Volume .....	10-2

**KEYPADS & READERS**

All On Allowed .....	10-3
All User Areas .....	10-3
Chime Tone .....	10-6
Disarming Allowed .....	10-3
Display Area Icons .....	10-6
Display Temperature .....	10-6
Door Assignment .....	10-8
Egress Input .....	10-5
Entry Exit Warning .....	10-6
Extinguish .....	10-6
General Options .....	10-5
Greetings .....	10-6
Home Area .....	10-4
Home Area Only .....	10-3
Installer PIN Allowed .....	10-5
Lockout Time .....	10-8
Log Egress Events .....	10-5
Name .....	10-3
Part Exit Warning .....	10-6
Part On Allowed .....	10-3
PIN To Change Area .....	10-4
Reader Area Control .....	10-5
Reader Badging .....	10-5
Rear Tamper .....	10-5
Report Temperature .....	10-5
Show Alarm When Armed .....	10-5
Single Key Control .....	10-3
Temperature Display .....	10-6
Zero Exit Time .....	10-3

Keyswitch Input On/Off, Flash Strobe .....	6-6
Keyswitch Options .....	7-12
Keyswitch Tamper Alarm .....	6-5

**L**

Language .....	11-16
LAN Scan .....	10-2
LAN Secure .....	10-1
Link To Common Area .....	6-4
Locale .....	11-7
Lockout Dialler .....	7-9
Lockout Siren .....	7-10
Log Threshold .....	9-10

**M**

Monitor Default PIN Codes .....	11-13
Multi Tenant Mode .....	11-16
MyAlarm	
Email Address .....	9-17
Email Options .....	9-17
Gateway Numbers .....	9-16
IP Address .....	9-16
IP Port .....	9-16
MyAlarm Options .....	9-16

**N**

Non Sequential Handover .....	6-4
-------------------------------	-----

**O****OPEN/CLOSE REPORTS**

Only After Alarm .....	6-6
Part On .....	6-6
Report Route .....	6-8
User Options - Always Send .....	5-8

**OUTPUTS**

Default Table .....	8-16
Event Assignment .....	8-9
Event Type .....	8-4
Event Types Table .....	8-15
Mapping .....	8-16
Output Array .....	4-4
Output Name .....	8-4
Output Options .....	8-11
Output Polarity .....	8-9
Output Status .....	8-1
Time Parameter .....	8-10
Turn Output On/Off .....	8-2

**Output Testing**

External Siren Test .....	8-13
Internal Bell Test .....	8-14
Strobe Siren Test .....	8-14

Overview .....	1-1
----------------	-----

**P**

Panel Status .....	11-1
Part 2 Zones .....	7-3
Part Entry Time .....	6-9
PGM Input Type .....	7-13
Phone Line Options .....	9-7
Phone Number Prefix .....	9-4
Phone Number Programming .....	4-2, 9-4
PIN	
Add .....	5-4

Always Required .....	11-14	Sensor Watch Time.....	7-15
Change Other PIN .....	5-3	Service Interval.....	6-11
Change Own PIN .....	5-3	SERVICE MODE .....	11-5
Installer PIN.....	5-11	Silencing Alarms.....	4-10
Length .....	5-10	Silent Alarm .....	7-10
Retry Count.....	5-10	Silent Burglary Alarm .....	6-6
Retry Report.....	6-6	Single Key	
<b>Power Up</b>		Arming.....	6-4
Disarmed.....	11-14	Off, From Part On .....	6-4
Same State .....	11-14	Part On.....	6-4
<b>PROGRAMMING</b>		Siren Reset All Users .....	11-14
Alpha Text.....	4-2	Siren / Strobe When Part On.....	6-5
Clock.....	4-2	Siren Swinger.....	11-10
Defaulting.....	4-3	Site Name .....	11-16
Entering Programming Mode .....	4-1	Smart Lockout.....	6-6
Exiting Programming Mode.....	4-1	Smoke Sensor Reset .....	7-4
List Options.....	4-1	SMS Password .....	9-9
Menu Navigation .....	4-1	<b>SOLUTION LINK</b>	
Option Bits .....	4-1	Call/Answer RAS .....	9-1
Overview.....	4-1	Call Back Number.....	9-9
Phone Numbers .....	4-2	Call Back Verify.....	9-11
Service Mode.....	4-3	RAS Options .....	9-10
<b>PROGRAMMING EXAMPLES</b>		RAS Security PIN .....	9-10
Auto Arming an Area.....	12-1	Start Direct Link .....	9-2
Opening a Door using a Single Digit Code .....	12-1	<b>Speaker Beeps</b>	
Opening Garage Door Using a 4 Button Keyfob ..	12-1	Volume.....	11-9
Operating an Output with a TimeZone.....	12-2	<b>SPECIFICATIONS</b> .....	13-1
Sending SMS Alarm Reports.....	12-3	<b>Strobe Trigger</b> .....	6-6
Unlock Door and Disarm Area via Reader .....	12-2	<b>Summertime Off</b> .....	11-6
Unlock Door & Arm/Disarm Area via Reader .....	12-2	<b>Summertime On</b> .....	11-6
Using CLI To Establish SolutionLink Connection ..	12-3	<b>Supervision Time</b> .....	10-9
<b>Pulse Count</b>		<b>Swinger Dialler</b> .....	9-15
Pulse Count Handover Allowed.....	6-4	<b>SYSTEM OPTIONS</b>	
Pulse Count Time .....	7-8	Area Options .....	11-14
<b>R</b>		General Options .....	11-13
<b>RAS Options</b> .....	9-10	Installer Options .....	11-15
<b>RAS Security PIN</b> .....	9-10	<b>SYSTEM POWER</b>	
<b>DTMF Quick Arm</b> .....	4-11	AC Options .....	11-7
<b>Remote Arming</b> .....	4-11	Arming Allowed On Low Battery .....	11-8
<b>REPORTING OPTIONS</b>		Battery Options.....	11-8
Burg Report Delay .....	9-15	Fuse Options .....	11-8
Emergency Route.....	9-15	Synchronise System Clock to AC.....	11-7
Fire Report Delay .....	9-15	<b>System Route</b> .....	9-14
Swinger Dialler .....	9-15	<b>System Trouble</b> .....	11-1
System Route.....	9-14	Messages.....	11-2
Test Route .....	9-14	<b>T</b>	
TX Format Dest 1 .....	9-14	<b>Tamper Options</b> .....	7-14
TX Format Dest 2 .....	9-14	<b>Telephone Number Prefix</b> .....	9-4
<b>Report LAN Fail</b> .....	11-13	<b>Terminal Descriptions</b> .....	3-2
<b>RF Devices</b>		<b>TESTING THE SYSTEM</b> .....	4-4
Add RF Device .....	7-11	Battery Test.....	11-17
Delete RF Device.....	7-12	Dial Number Test .....	9-26
RF Device Options .....	10-10	External Siren Test .....	8-13
RF Receiver Options.....	10-9	Internal Siren Test.....	8-14
Supervision Time .....	10-9	Send Test Report.....	9-24
Test RF Device .....	7-12	Strobe Test .....	8-14
View RF ID.....	10-10	Walk Test All Zones.....	11-17
<b>RF Receiver Options</b> .....	10-9	<b>Test On Exit</b> .....	7-11
<b>Ring Count</b> .....	9-10	<b>Test Report</b>	
<b>S</b>		Dial Number Test .....	9-26
<b>Senior Watch</b> .....	6-5	Options .....	9-25
<b>Senior Watch Time</b> .....	6-10	Period.....	9-25
<b>Sensor Watch</b> .....	7-11	Route .....	9-14, 9-26
		Send Test .....	9-24



Time	9-24
<b>TIMEZONE</b>	
Array	11-5
Day	11-11
Name	11-11
Options	11-12
Time	11-11
User Properties	5-9
<b>Token</b>	
Edit	5-5
Add Token	5-4
Delete Token	5-5
Token Status	5-5
<b>Tone Bypass</b>	<b>9-11</b>
<b>Trouble Alert Beeps</b>	<b>10-6</b>
<b>Turn Area Off</b>	<b>4-10</b>

## U

<b>USERS</b>	
Add PIN	5-4
Add Token	5-4
Area Assignment	5-7
Auto Bypass Allowed	5-8
Bypass Zones Allowed	5-8
Change Other PIN	5-3
Change Own PIN	5-3
Default Table	5-2
Delete PIN	5-4
Delete Token	5-5
Door Assignment	5-9
Erase User	5-2
Expire Date	5-10
PIN Retry Count	5-10
Send Open/Close	5-8
TimeZone Access	5-9
User Name	5-7
User Options	5-8
User RAS PIN	9-13
User Test Interval	6-11
User Test Required	6-12
View PIN	5-4

## V

View PIN	5-4
View RF Device ID	10-10
Voice Access Code	9-12
Voice Module Setup	9-2

## W

Walk Test All Zones	7-14, 11-17
Walk Test A Zone	7-14
<b>Walk Test Options</b>	
User Test Required	6-12
Walk Test 24Hr Zones	6-12
Walk Test Fire Zones	6-12
Walk Test Reports	6-12

## WIRING

Board Connectors	3-2
PCB Overlay	3-6
Terminal Descriptions	3-2
Zone Wiring	3-1

## Z

Bypass Zones	7-2
Zone Array	7-2
Zone Mapping	7-1
<b>ZONES</b>	
Add RF Device	7-11
Area Assignment	7-6
Armed When Part On	7-11
Bypass Zones	7-2
Delete RF Device	7-12
Door Assignment	7-9
EOL Value	7-12
Input Options	7-13
Input Testing	7-14
Input Type	7-13
Inverted Seal	7-10
Keyswitch Options	7-12
Name	7-4
NO EOL Required	7-11
Overview	1-1
Report Options	7-9
Report Route	7-9
Sensor Watch	7-11
Set Chime Zones	7-3
Set Part 2 Zones	7-3
Tamper Options	7-14
Test On Exit	7-11
Test RF Device	7-12
Wiring	3-1
Zone Options	7-10
Zone Status	7-2
Zone Type	7-5

Bosch Security Systems  
25 Huntingwood Drive  
Huntingwood, NSW 2128  
Australia  
Phone: +612 9672 1777  
Facsimile: +612 9672 1717

© 2012 Bosch Security Systems  
BLCC600BI  
920305  
Issue FTR1.0

**BOSCH**