

# Plate Door Handles



 accesshardware

BUSINESS  
REWARDS 

We take the worry out of  
protecting what's valuable to you.  
Lockwood: *no worries*<sup>®</sup>

**LOCKWOOD**

**ASSA ABLOY**

**25YEAR**

MECHANICAL  
WARRANTY

[www.lockweb.com.au](http://www.lockweb.com.au)



# Contents



## 1800 Series

Square End Brass Plate Furniture

page 4



## 2800 Series

Round End Brass Plate Furniture

page 6



## 4800 Series

Narrow Plate Brass Door Furniture

page 9



## 5800 Series

Narrow Plate Brass Door Furniture

page 12



## Brass Levers

page 18



## 200 Series Artefact

Square Corner Plate Furniture

page 27



## 202 Series Artefact

Radius Corner Plate Furniture

page 29



## 212 Series Artefact

Oval Corner Plate Furniture

page 32



## 224 Series Artefact

Rectangular Plate Furniture

page 34



## Detention Series

Square and Rectangular Furniture

page 37



## Palladium Series

Door Handles

page 47



## Diecast Levers

page 51



## Finishes

page 58

**Brass Furniture Thicker Door Accessories** \_\_\_\_\_ 56

**Lockwood Door Furniture Handing Convention** \_\_\_\_\_ 57

# 1800 Series Square End Brass Plate Furniture



The 1800 Series features a classic rectangular plate with bevelled edges. Suits corporate, commercial and public spaces with high use requirements.

## Application

Designed for use with Lockwood Selector and Synergy Mortice Locks and Latches.

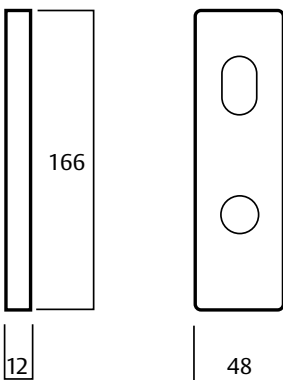

## Product Details

<b>Door Thickness</b>	External plates are supplied with fixing screws to suit door thickness between 32 and 45mm. For thicker doors, please refer to the brass furniture thicker doors page at the end of this catalogue section.
<b>Dimensions</b>	166 x 48 x 12mm
<b>Fixing</b>	Plates are designed to fit back to back. If outside plate is specified with concealed fixing, then the inside plate must be visible fixed.
<b>Handing</b>	Plates are not handed; levers may be reversed by removing the stop screw, except for handed levers and functions as shown in the ordering procedure at the end of this section.
<b>Decorative Finishes</b>	<p><b>Standard Finish:</b> Satin Chrome Brushed (SC)</p> <p><b>Non Standard Finishes:</b> Chrome Plate (CP) Polished Brass (PB) Polyester Powdercoat (PC)*</p> <p><b>Special Finishes:</b> Architectural Bronze (AZ) Architectural Bronze Unlaqured (AU) Antique Copper (AC) Oil Rubbed Bronze (ORB) Polished Brass Unlaqured (BU) Satin Brass (SB)</p>
<b>Turn Functions Adjustable Tailbar</b>	Turn functions feature a unique mechanism that automatically adjusts the length of the tail bar to suit a particular door thickness.

\* Refer to the end of this catalogue for detailed images of all decorative finishes that suit this range.

## Standards and Compliance

1800 series has been successfully tested up to 4 hours with a fire rated Lockwood mortice lock on fire door assemblies (depending on type of doorset) in accordance with Australian Standard AS1905.1:2005, Fire Resistant Doorsets.



1800 series door furniture has been successfully tested with a Selector 3772 mortice lock and Abloy Protec<sup>2</sup> CY504 cylinder to conform with Level S8 under AS4145.2-2008, Locksets and hardware for doors and windows.

S8

1800 series lever sets have been successfully tested to conform with Level D8 (500,000 cycles) under Australian Standard AS4145.2-2008, Locksets and hardware for doors and windows.

D8

1800 series in brushed satin chrome finish has been successfully tested to conform with Level C10 (1000 hours) under Australian Standard AS4145.2-2008, Locksets and hardware for doors and windows.



1800 Series is designed, assembled and customised in Australia to suit the requirements of the Australian Market.

1800 series includes levers and turns (as shown) that meet the requirements of AS1428.1-2009, Design for access and mobility.



# 1800 Series Levers and Functions

## Plates and Functions

1800	1801	1803	1804	1805	1806	1807	1808	1809	1810	1813	1814	
Exterior Plate Cylinder Only	Exterior Plate Cylinder & Lever	Exterior Plate Emergency Turn & Lever	Exterior Plate Turnknob & Lever	Exterior Plate Lever Only	Exterior Plate Turnknob Only	Exterior Plate Plain Plate	Exterior Plate Fixed Lever & Cylinder	Exterior Plate Fixed Lever	Exterior Plate Dual Cylinder	Exterior Plate Privacy Indicating Emergency Turn	Exterior Plate Privacy Indicating Emergency Turn & Lever	
1815	1816	1820	1821	1822	1823							
Exterior Plate Privacy Indicating Turnknob	Exterior Plate Privacy Indicating Turnknob & Lever	Exterior Plate Cylinder, Lever & LED	Exterior Plate Cylinder, Fixed Lever & LED	Exterior Plate Lever & LED	Exterior Plate Cylinder & LED							
1900	1901	1904	1905	1906	1907	1908	1909	1920	1921	1922	1939*	1941*
Interior Plate Cylinder Only	Interior Plate Cylinder & Lever	Interior Plate Turnknob & Lever	Interior Plate Lever Only	Interior Plate Turnknob Only	Interior Plate Plain Plate	Interior Plate Cylinder & Lever	Interior Plate Fixed Lever	Interior Plate Cylinder, Lever & LED	Interior Plate Cylinder, Fixed Lever & LED	Interior Plate Lever & LED	Interior Plate Disabled Turnknob & Lever	Interior Plate Privacy Indicating Disabled Turnknob & Lever

\* Refer to ordering procedure for part number when ordering with 3770 Series.

### Plates and Functions Legend

Cylinder Hole		Fixed Lever		Indicating Turnknob	
Turnknob		Disabled Turnknob		Indicating Emergency Turn	
Emergency Turn		LED		Lever	

**Note:** Refer to page 18 for images of levers and knob styles available.

# 2800 Series Round End Brass Plate Furniture



The 2800 Series features a classic oval shaped plate. Suits corporate, commercial and public spaces with high use requirements.

## Application

Designed for use with Lockwood Selector and Synergy Mortice Locks and Latches.

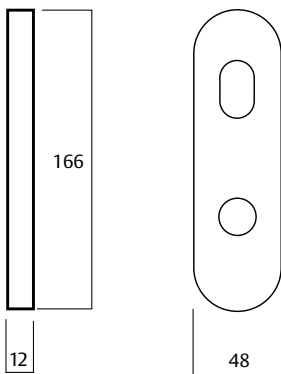

## Product Details

### Door Thickness

External plates are supplied with fixing screws to suit door thickness between 32 and 45mm. For thicker doors, please refer to the brass furniture thicker doors page at the end of this catalogue section.

### Dimensions

166 x 48 x 12mm

### Fixing

Plates are designed to fit back to back. If outside plate is specified with concealed fixing, then the inside plate must be visible fixed.

### Handing

Plates are not handed; levers may be reversed by removing the stop screw, except for handed levers and functions as shown in the ordering procedure at the end of this section.

### Decorative Finishes

**Standard Finish:**  
Satin Chrome Brushed (SC)

**Non Standard Finishes:**  
Chrome Plate (CP)  
Polished Brass (PB)  
Polyester Powdercoat (PC)\*

**Special Finishes:**  
Architectural Bronze (AZ)  
Architectural Bronze Unlaqured (AU)  
Antique Copper (AC)  
Oil Rubbed Bronze (ORB)  
Polished Brass Unlaqured (BU)  
Satin Brass (SB)

### Turn Functions Adjustable Tailbar

Turn functions feature a unique mechanism that automatically adjusts the length of the tail bar to suit a particular door thickness.

\* Refer to the end of this catalogue for detailed images of all decorative finishes that suit this range.

## Standards and Compliance



2800 Series has been successfully tested up to 4 hours with a fire rated Lockwood mortice lock on fire door assemblies (depending on type of doorset) in accordance with Australian Standard AS1905.1:2005, Fire Resistant Doorsets.

**D8**

2800 Series lever sets have been successfully tested to conform with Level D8 (500,000 cycles) under Australian Standard AS4145.2-2008, Locksets and hardware for doors and windows.



2800 Series in brushed satin chrome finish has been successfully tested to conform with Level C10 (1000 hours) under Australian Standard AS4145.2-2008, Locksets and hardware for doors and windows.

2800 Series is designed, assembled and customised in Australia to suit the requirements of the Australian Market.



2800 Series includes levers and turns (as shown) that meet the requirements of AS1428.1-2009, Design for access and mobility.

# 2800 Series Levers and Functions

## Plates and Functions

2800 2801 2803 2804 2805 2806 2807 2808 2809 2810 2813

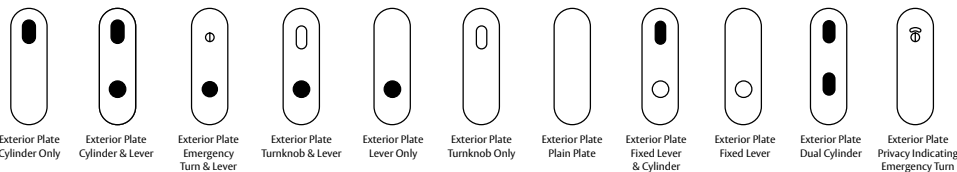

2814 2815 2816 2820 2821 2822 2823

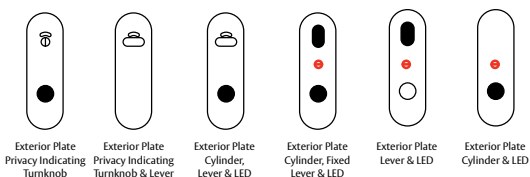

2900 2901 2904 2905 2906 2907 2908 2909 2920 2921 2922 2939\* 2941\*

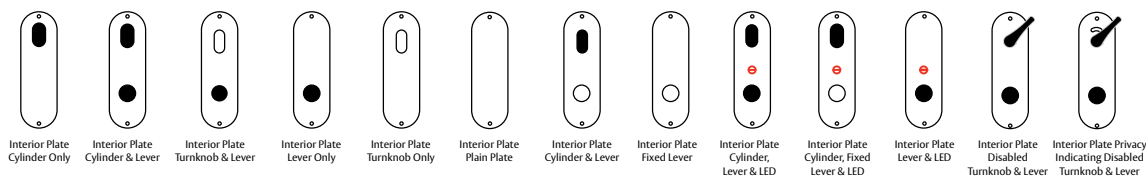

\* Refer to ordering procedure for part number when ordering with 3770 Series.

### Plates and Functions Legend

Cylinder Hole		Fixed Lever		Indicating Turnknob	
Turnknob		Disabled Turnknob		Indicating Emergency Turn	
Emergency Turn		LED		Lever	

**Note:** Refer to page 18 for images of levers and knob styles available.

# 1800 and 2800 Series Ordering Procedure

## For example:

Sample part number 1801/41LCP is made up of several selections. Choose your product by selecting an option from each section.

Plate Type	Plate Function	Lever/ Knob	Handing	Finish
18	01	41	L	CP

### Plate Type

Exterior Square End	18
Interior Square End	19
Exterior Round End	28
Interior Round End	29

### Plate Function

Cylinder Only	00
Cylinder & Lever	01
Emergency Turn & Lever	03
Turnknob & Lever	04
Lever Only	05
Turnknob Only	06
Plain Plate	07
Cylinder & Fixed lever	08
Fixed Lever Only	09
Two Cylinders	10
Privacy Indicating Emergency Turn Only	13
Privacy Indicating Emergency Turn & Lever	14
Privacy Indicating Turnknob Only	15
Privacy Indicating Turnknob & Lever	16
Privacy Indicating Emergency Turn & Lower Cylinder	19
Cylinder, Lever & LED	20
Cylinder, Fixed Lever & LED	21
Lever & LED	22
Cylinder & LED	23

### Plate Function - Handed

Disabled Accessible Turnknob & Lever	39
Privacy Indicating Disabled Turnknob & Lever	41

### AS1428.1 Compliant Lever Types

102	111	112
115	116	118
124	131	132
133	142	144
145	155	166
47	59	70
74	76	77
90		

### Non Compliant Lever/knob Types

101	104	106
123	178	97
20		

### Handed Levers

41	122	153
----	-----	-----

Refer to page 18 for detailed images of the levers and knobs that suit this range.

### Handing

Right Handed	R
Left Handed	L
NB: Omit if non-handed	

### Finish

Antique Copper	AC
Architectural Bronze Unlacquered	AU
Chrome Plate	CP
Oil Rubbed Bronze	ORB
Polished Brass	PB
Polished Brass Unlacquered	BU
Polyester Powdercoat	PC*
Satin Brass	SB
Satin Chrome	SC

Refer to the end of this catalogue for detailed images of all decorative finishes from this section.



# 4800 Series Narrow Plate Brass Door Furniture



A slimline, rectangular brass plate that adds style to your choice of lever.

## Application

Designed for use with Lockwood Selector and Synergy Series short and standard backset mortice locks.

Additionally there are functions that are designed to work with Lockwood 3540 Series short backset mortice deadbolts.

**Note:** Certain lever designs are not compatible on short backset assemblies due to interference with the door stop. Refer to the backset suitability page at the end of this section.

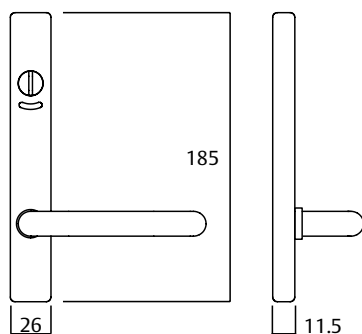

## Product Details

### Door Thickness

External plates are supplied with fixing screws to suit door thickness between 32 and 50mm. For thicker doors, please refer to the brass furniture thicker doors page at the end of this catalogue section.

### Dimensions

185 x 26 x 11.5mm

### Fixing

Plates are designed to fit back to back. If outside plate is specified with concealed fixing, then the inside plate must be visible fixed.

### Handing

Plates are not handed; levers may be reversed by removing the stop screw, except for handed levers and functions as shown in the ordering procedure at the end of this section.

### Decorative Finishes

#### Standard Finish:

Satin Chrome Brushed (SC)

#### Non Standard Finishes:

Chrome Plate (CP)  
Polished Brass (PB)  
Polyester Powdercoat (PC)\*

#### Special Finishes:

Aged Brass (AG)  
Architectural Bronze (AZ)  
Architectural Bronze Unlaqured (AU)  
Antique Copper (AC)  
Oil Rubbed Bronze (ORB)  
Polished Brass Unlaqured (BU)  
Satin Brass (SB)  
Satin Brass Unlacqured (SBU)

### Turn Functions Adjustable Tailbar

Turn functions feature a unique mechanism that automatically adjusts the length of the tail bar to suit a particular door thickness.

\* Refer to the end of this catalogue for detailed images of all decorative finishes that suit this range.

## Standards and Compliance

4600 Series has been successfully tested up to 4 hours with a fire rated Lockwood mortice lock on fire door assemblies (depending on type of doorset) in accordance with Australian Standard AS1905.1:2005, Fire Resistant Doorsets.



4800 Series lever sets have been successfully tested to conform with Level D8 (500,000 cycles) under Australian Standard AS4145.2-2008, Locksets and hardware for doors and windows.

**D8**

4800 Series in brushed satin chrome finish has been successfully tested to conform with Level C10 (1000 hours) under Australian Standard AS4145.2-2008, Locksets and hardware for doors and windows.



4800 Series is designed, assembled and customised in Australia to suit the requirements of the Australian Market.

4800 Series includes levers and turns (as shown) that meet the requirements of AS1428.1-2009, Design for access and mobility.



# 4800 Series Plate Functions

## Plates and Functions

(See page 17 and 18 for detailed ordering procedure table and part numbers)

### To suit 3780 Series Mortice Locks

#### 4800/4900

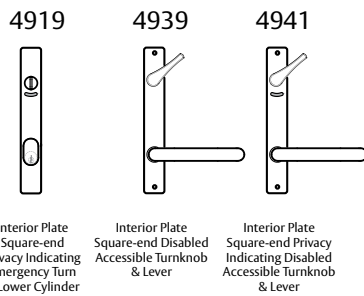
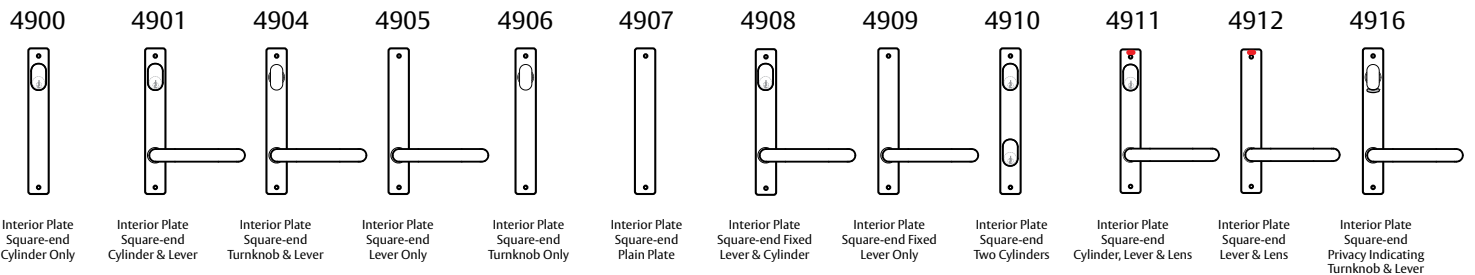
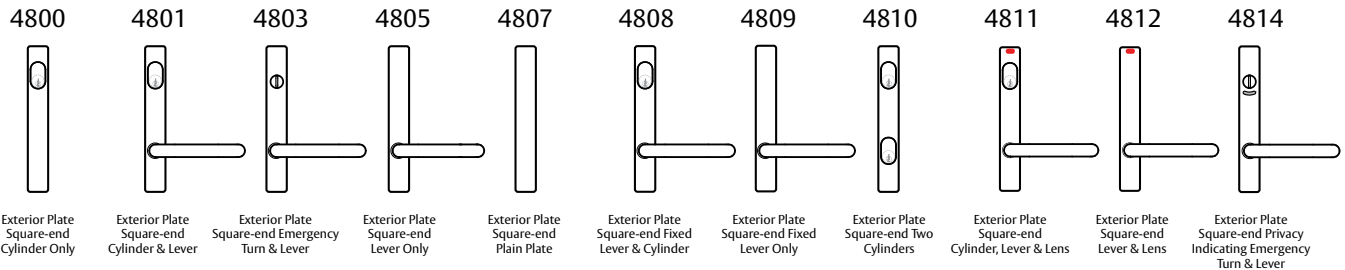

**Note:** Refer to page 18 for images of levers and knob styles available.

# 4800 Series Plate Functions

To suit 3770 & 3570 Series Mortice Locks   
**4600/4700 (fire rated)**

Functions 05, 07 & 09 use  
 4800 / 4900 plate versions

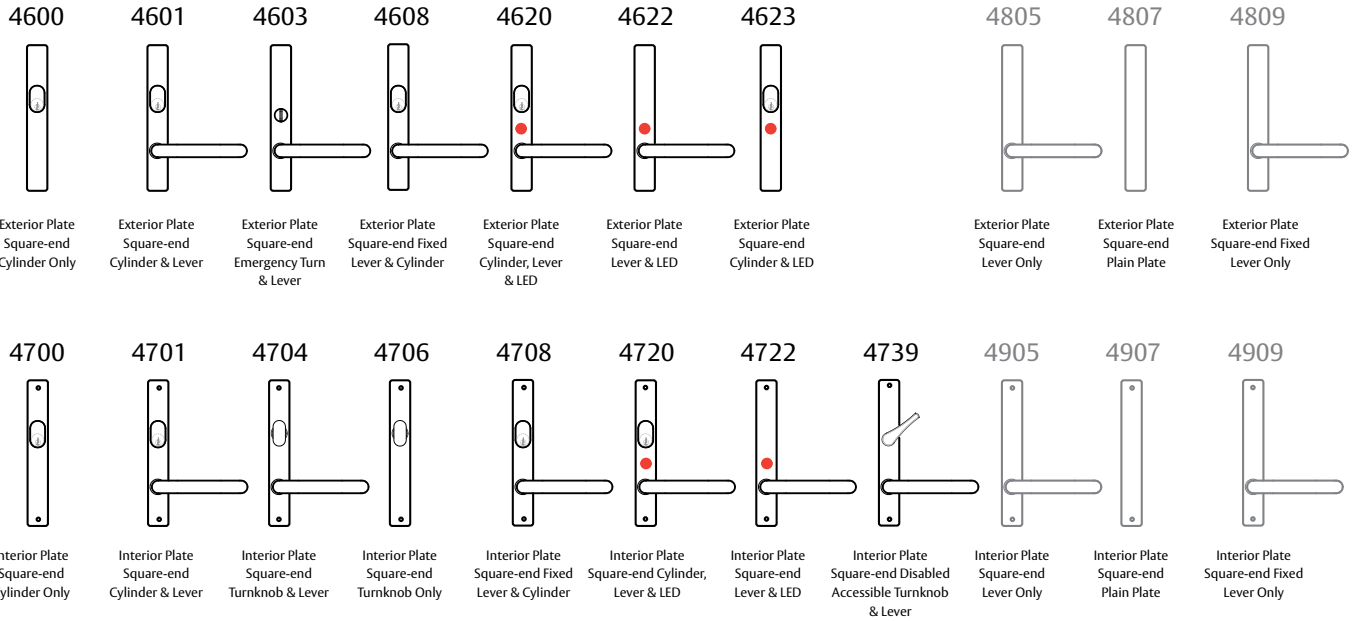

To suit 3540 Series Motice Locks

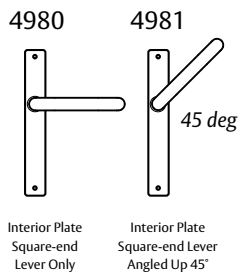

**Note:** Refer to page 18 for images of levers and knob styles available.

# 5800 Series Narrow Plate Brass Door Furniture



Functional, yet elegant, the soft lines of this round ended brass plate complement a wide range of levers.

## Application

Designed for use with Lockwood Selector and Synergy Series short and standard backset mortice locks.

Additionally there are functions that are designed to work with Lockwood 3540 Series short backset mortice deadbolts.

**Note:** Certain lever designs are not compatible on short backset assemblies due to interference with the door stop. Refer to the backset suitability page at the end of this section.

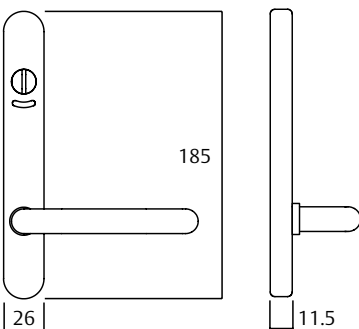

## Product Details

**Dimensions** 185 x 26 x 11.5mm

**Door Thickness** External plates are supplied with fixing screws to suit door thickness between 32 and 50mm. For thicker doors, please refer to the brass furniture thicker doors page at the end of this catalogue section.

**Fixing** Plates are designed to fit back to back. If outside plate is specified with concealed fixing, then the inside plate must be visible fixed.

**Handing** Plates are not handed; levers may be reversed by removing the stop screw, except for handed levers and functions as shown in the ordering procedure at the end of this section.

**Standard Finish:**  
Satin Chrome Brushed (SC)

**Non Standard Finishes:**  
Chrome Plate (CP)  
Polished Brass (PB)  
Polyester Powdercoat (PC)\*

**Decorative Finishes:**  
Aged Brass (AG)  
Architectural Bronze (AZ)  
Architectural Bronze Unlaqured (AU)  
Antique Copper (AC)  
Oil Rubbed Bronze (ORB)  
Polished Brass Unlaqured (BU)  
Satin Brass (SB)  
Satin Brass Unlacqured (SBU)

**Turn Functions Adjustable Tailbar** Turn functions feature a unique mechanism that automatically adjusts the length of the tail bar to suit a particular door thickness.

\* Refer to the end of this catalogue for detailed images of all decorative finishes that suit this range.

## Standards and Compliance

5600 Series has been successfully tested up to 4 hours with a fire rated Lockwood mortice lock on fire door assemblies (depending on type of doorset) in accordance with Australian Standard AS1905.1:2005, Fire Resistant Doorsets.



5800 Series lever sets have been successfully tested to conform with Level D8 (500,000 cycles) under Australian Standard AS4145.2-2008, Locksets and hardware for doors and windows.

**D8**

5800 Series in brushed satin chrome finish has been successfully tested to conform with Level C10 (1000 hours) under Australian Standard AS4145.2-2008, Locksets and hardware for doors and windows.



5800 Series is designed, assembled and customised in Australia to suit the requirements of the Australian Market.

5800 Series includes levers and turns (as shown) that meet the requirements of AS1428.1-2009, Design for access and mobility.



# 5800 Series Plate Functions

## Plates and Functions

(See Page 17 and 18 for Detailed Ordering Procedure Table and Part Numbers)

To suit 3780 Series Mortice Locks

5800/5900

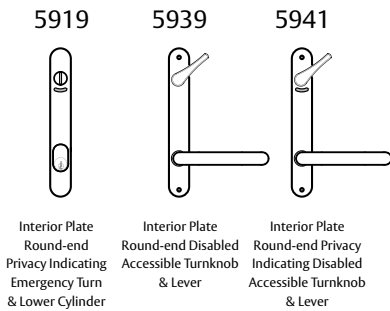
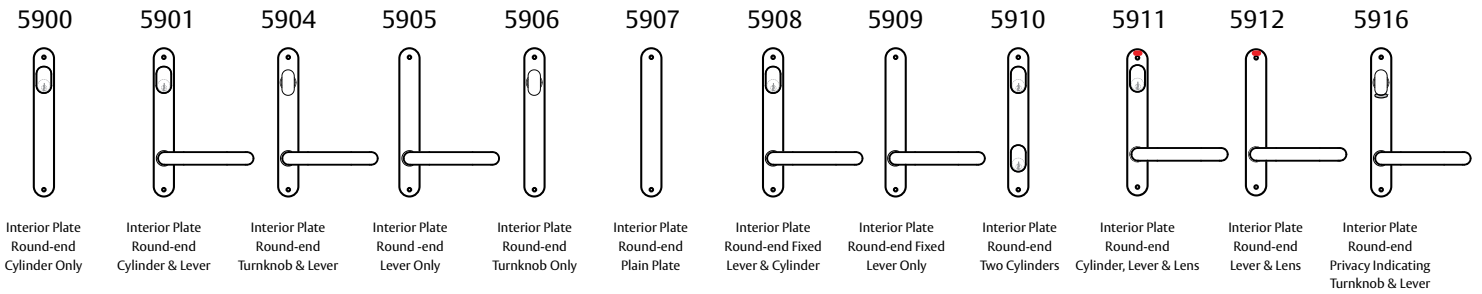
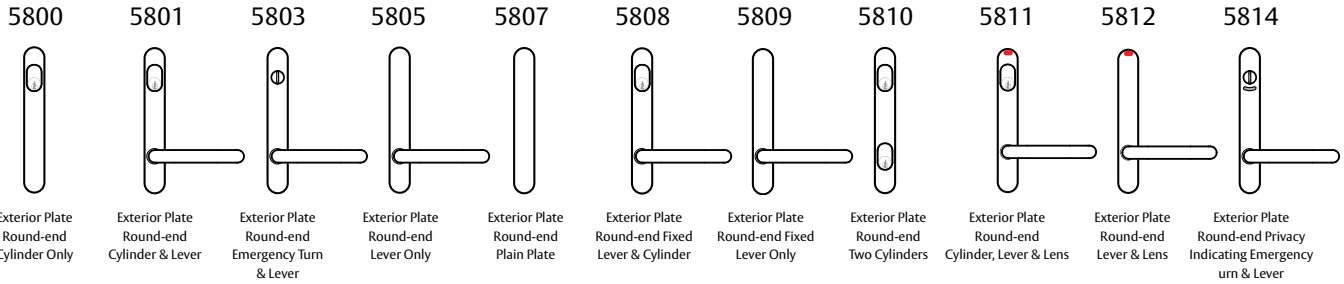

**Note:** Refer to page 18 for images of levers and knob styles available.

# 5800 Series Plate Functions

To suit 3770 & 3570 Series Mortice Locks   
**5600/5700 (fire rated)**

Functions 05, 07 & 09 use  
 5800 / 5900 plate versions

5600	5601	5603	5608	5620	5622	5623
Exterior Plate Round-end Cylinder Only	Exterior Plate Round-end Cylinder & Lever	Exterior Plate Round-end Emergency Turn & Lever	Exterior Plate Round-end Fixed Lever & Cylinder	Exterior Plate Round-end Cylinder, Lever & LED	Exterior Plate Round-end Lever & LED	Exterior Plate Round-end Cylinder & LED

5805	5807	5809
Exterior Plate Round-end Lever Only	Exterior Plate Round-end Plain Plate	Exterior Plate Round-end Fixed Lever Only

5700	5701	5704	5706	5708	5720	5722	5739	5905	5907	5909
Interior Plate Round-end Cylinder Only	Interior Plate Round-end Cylinder & Lever	Interior Plate Round-end Turnknob & Lever	Interior Plate Round-end Turnknob Only	Interior Plate Round-end Fixed Lever & Cylinder	Interior Plate Round-end Cylinder, Lever & LED	Interior Plate Round-end Lever & LED	Interior Plate Round-end Disabled Accessible Turnknob & Lever	Interior Plate Round-end Lever Only	Interior Plate Round-end Plain Plate	Interior Plate Round-end Fixed Lever Only

To suit 3540 Series Mortice Locks

5980	5981
Interior Plate Round-end Lever Only	Interior Plate Round-end Lever Angled Up 45°

**Note:** Refer to page 18 for images of levers and knob styles available.

# 4800 & 5800 Series Ordering Procedure

## Example:

Sample part number 4801/53LCP is made up of several selections. Choose your product by selecting an option from each section.

**Ordering procedure for door furniture to be used with Selector Series Mortice Locks 3770 and 3780 and for use with Synergy Series Mortice Locks 3570.**

Plate Type	Plate Function	Lever Type	Handing	Finish
48	01	53	L	CP

Plate Type	
<b>Standard backset mortice locks 3570 Series (Synergy) and 3770 Series (Selector)</b>	
Exterior Square End	46
Interior Square End	47
Exterior Round End	56
Interior Round End	57
<b>Short backset mortice locks 3780 Series (Selector)</b>	
Exterior Square End	48
Interior Square End	49
Exterior Round End	58
Interior Round End	59

Plate Function	
Cylinder Only	00
Cylinder & Lever	01
Emergency Turn & Lever	03
Turnknob & Lever	04
Lever Only	05
Turnknob Only	06
Plain Plate	07
Two Cylinders	10

Plate Functions - 3570EL Series Synergy Electric Mortice Locks only	
Cylinder, Lever & LED	20
Lever & LED	22
Cylinder & LED	23
Disabled Accessible Turnknob & Lever	39

Plate Functions - 3780 Series Mortice Lock only	
Privacy Indicating Emergency Turn & Lever	14
Privacy Indicating Turnknob & Lever	16
Privacy Indicating Turnknob & Lower Cylinder	19
Privacy Indicating Disabled Accessible Turnknob & Lever	41

Plate Function - Handed	
Fixed Lever & Cylinder	08
Fixed Lever Only	09
Cylinder, Fixed Lever & LED	21

Plate Functions - 3780EL Series Selector Electric Mortice Locks only	
Cylinder, Lever and Lens	11
Lever & Lens	12

AS1428.1 Compliant Lever Types		
102	111	112
115	116	118
124	131	132
133	142	144
145	155	166
47	59	70
74	76	77
90		

Non Compliant Lever/Knob Types		
101	104	106
123	178	97
20		

Handed Levers		
41	122	153

**Notes:** Certain lever designs are not compatible on short backset assemblies. See page 17 for specific lever design suitability details.

Refer to page 18 for detailed images of the levers and knobs that suit this range.

Handing	
Right Handed	R
Left Handed	L

NB: Omit if non-handed

Finish	
Aged Brass	AG
Architectural Bronze	AZ
Architectural Bronze Unlacquered	AU
Antique Copper	AC
Chrome Plate	CP
Oil Rubbed Bronze	ORB
Polished Brass	PB
Polished Brass Unlacquered	BU
Polyester Powdercoat	PC*
Satin Brass	SB
Satin Chrome	SC
Satin Brass Unlacquered	SBU

\* Refer to the end of this catalogue for detailed images of all decorative finishes from this section.

# 4800 & 5800 Series Ordering Procedure

## Ordering procedure for door furniture to be used with 3540 Series Mortice Locks

Plate Type	Plate Function	Lever Type	Finish
48	80	70	SC

Platform Name	
Exterior Square End	48
Interior Square End	49
Exterior Round End	58
Interior Round End	59

Plate Function	
Lever Only	80
Lever - Angled Up 45°	81

Lever Type	
67	
<b>AS1428.1 Compliant Levers</b>	
70	77

**Note:** Certain lever designs are not compatible on short backset assemblies. See page 17 for specific lever design suitability details.

See page 18 for details on lever images and dimensions.

Finish	
Aged Brass	AG
Architectural Bronze	AZ
Architectural Bronze Unlacquered	AU
Antique Copper	AC
Chrome Plate	CP
Oil Rubbed Bronze	ORB
Polished Brass	PB
Polished Brass Unlacquered	BU
Polyester Powdercoat	PC
Satin Brass	SB
Satin Brass Unlacquered	SBU
Satin Chrome	SC

\* Refer to the end of this catalogue for detailed images of all decorative finishes from this section.



# 4800 & 5800 Series Lever Suitability

## Application

All narrow style door furniture will be closer to the door frame. Lever handles with 90 degree angles can cause the lever stem to hit the door frame and prevent the door from opening. The table below provides a guide to lever compatibility and each model of short backset lock from 3782 to 6782. Based on 12mm doorstop.

Lever Number	3782 3540 23mm	4782 25.4	5782 30mm	6782 38mm
41	X	X	✓	✓
59	X	X	✓	✓
70	✓	✓	✓	✓
74	X	X	✓	✓
76	X	X	✓	✓
77	✓	✓	✓	✓
90	X	X	✓	✓
97	✓	✓	✓	✓
101	X	X	✓	✓
102	✓	✓	✓	✓
104	X	✓	✓	✓
106	X	X	✓	✓
111	X	X	✓	✓
112	X	X	✓	✓
115	✓	✓	✓	✓
116	X	X	✓	✓
118	X	X	✓	✓
122	X	X	✓	✓
122	X	X	✓	✓
123	X	X	✓	✓
124	X	X	✓	✓
131	X	X	✓	✓
132	X	X	✓	✓
133	X	X	✓	✓
144	X	✓	✓	✓
145	X	X	✓	✓
153	X	X	✓	✓
155	X	✓	✓	✓
166	X	X	✓	✓
178	X	X	✓	✓
180	X	✓	✓	✓

# Brass Levers and Knobs

## BRASS CORE

For use on the following door furniture series:

- 1220 Series
- 1420 Series
- 1360 Series
- 1370 Series
- 1800 Series
- 2800 Series
- 4800 Series
- 5800 Series
- Artefact Series

### AS1428.1 Compliant Levers

Lever 102	
<b>Length</b>	134.3mm
<b>Projection</b>	57.5mm

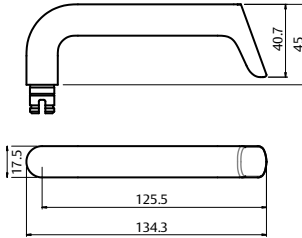

Lever 111	
<b>Length</b>	130mm
<b>Projection</b>	48.5mm

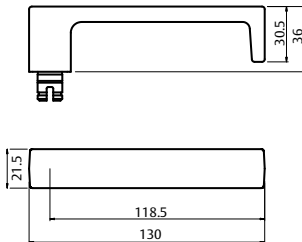

Lever 112	
<b>Length</b>	130.5mm
<b>Projection</b>	48mm

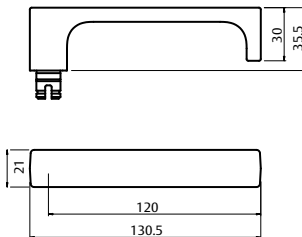

# Brass Levers and Knobs

## AS1428.1 Compliant Levers

Lever 115

<b>Length</b>	140.4mm
<b>Projection</b>	60mm

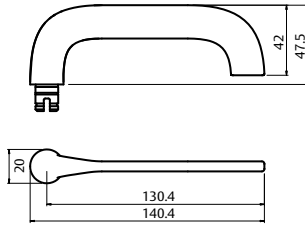

Lever 116

<b>Length</b>	140.5mm
<b>Projection</b>	47.6mm

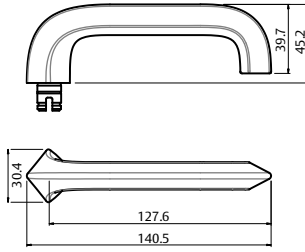

Lever 118

<b>Length</b>	128mm
<b>Projection</b>	58mm

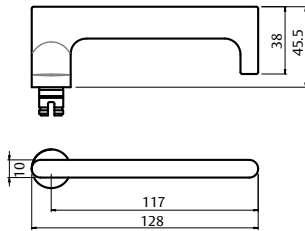

Lever 124

<b>Length</b>	130.5mm
<b>Projection</b>	59mm

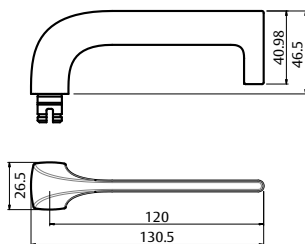

# Brass Levers and Knobs

## AS1428.1 Compliant Levers

### Lever 131

<b>Length</b>	134.5mm
<b>Projection</b>	53mm

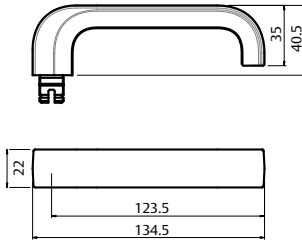

### Lever 132

<b>Length</b>	130mm
<b>Projection</b>	57.5mm

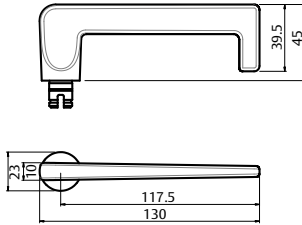

### Lever 133

<b>Length</b>	130mm
<b>Projection</b>	53.5mm

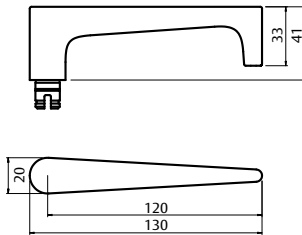

### Lever 142

<b>Length</b>	130.5mm
<b>Projection</b>	55mm

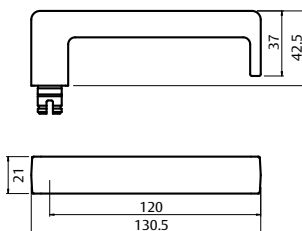

# Brass Levers and Knobs

## AS1428.1 Compliant Levers

### Lever 144

<b>Length</b>	128.8mm
<b>Projection</b>	57.5mm

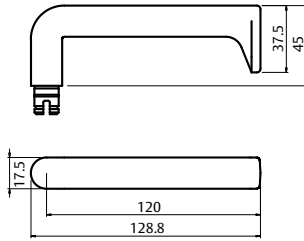

### Lever 145

<b>Length</b>	130mm
<b>Projection</b>	58.5mm

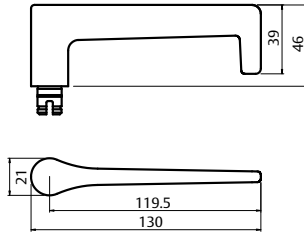

### Lever 155

<b>Length</b>	129.3mm
<b>Projection</b>	57.5mm

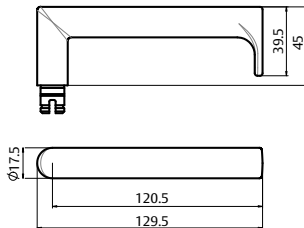

### Lever 166

<b>Length</b>	130mm
<b>Projection</b>	48mm

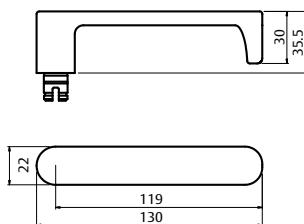

# Brass Levers and Knobs

## AS1428.1 Compliant Levers

### Lever 47

<b>Length</b>	120mm
<b>Projection</b>	49.6mm

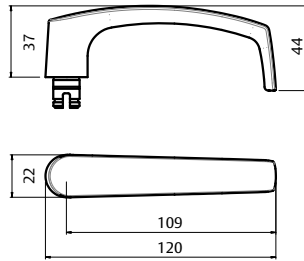

### Lever 59

<b>Length</b>	121mm
<b>Projection</b>	57.5mm

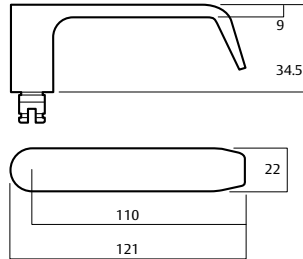

### Lever 70

<b>Length</b>	121mm
<b>Projection</b>	53mm

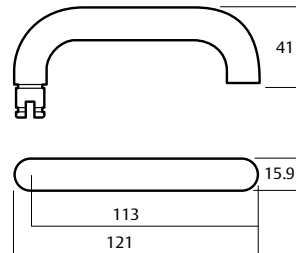

### Lever 74

<b>Length</b>	120mm
<b>Projection</b>	53mm

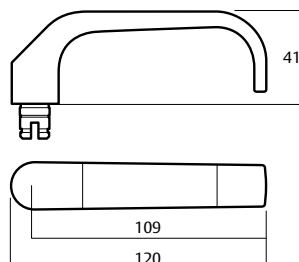

# Brass Levers and Knobs

## AS1428.1 Compliant Levers

### Lever 76

<b>Length</b>	125mm
<b>Projection</b>	48.5mm

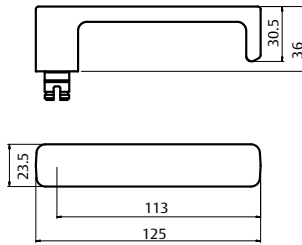

### Lever 77

<b>Length</b>	121mm
<b>Projection</b>	51mm

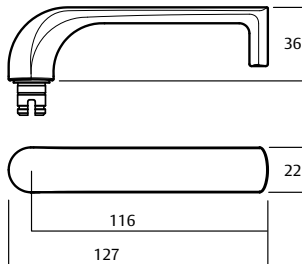

### Lever 90

<b>Length</b>	118.5mm
<b>Projection</b>	52mm

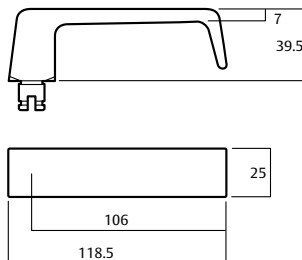

# Brass Levers and Knobs

## Non compliant lever/knob types

### Lever 101

<b>Length</b>	130mm
<b>Projection</b>	48.5mm

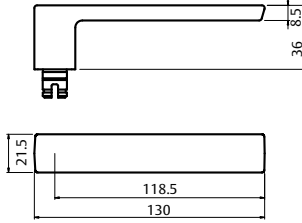

### Lever 104

<b>Length</b>	133.8mm
<b>Projection</b>	57.5mm

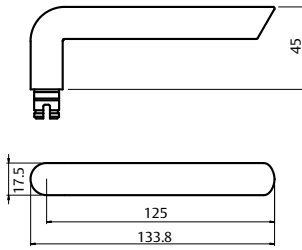

### Lever 106

<b>Length</b>	130mm
<b>Projection</b>	48mm

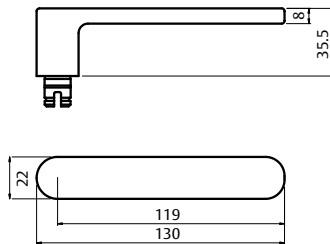

### Lever 123

<b>Length</b>	130.5mm
<b>Projection</b>	59mm

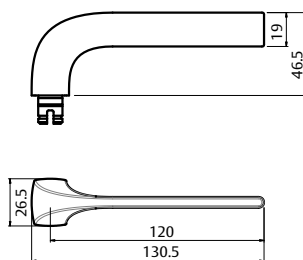



# Brass Levers and Knobs

## Non compliant lever/knob types

### Lever 178

<b>Length</b>	130mm
<b>Projection</b>	63.6mm

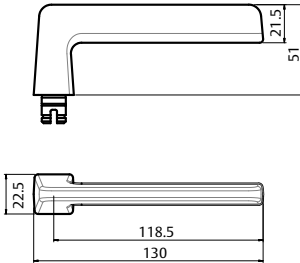

### Lever 97

<b>Length</b>	120mm
<b>Projection</b>	50.5mm

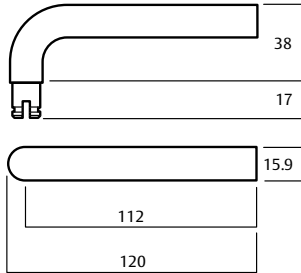

### Knob 20

<b>Diameter</b>	50mm
<b>Projection</b>	73mm

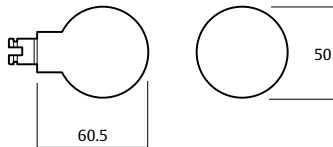

Not compatible with 1220 Symphony internal rose.

# Brass Levers and Knobs

## Handed Levers

### Lever 41

<b>Length</b>	130mm
<b>Projection</b>	61.5mm

\* Lever is an asymmetrical design and therefore must be handed.

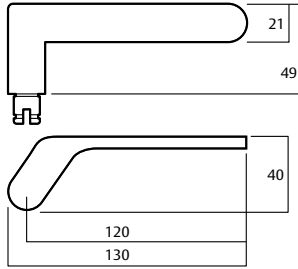

### Lever 122

<b>Length</b>	130.5mm
<b>Projection</b>	59mm

\* Lever is an asymmetrical design and therefore must be handed.

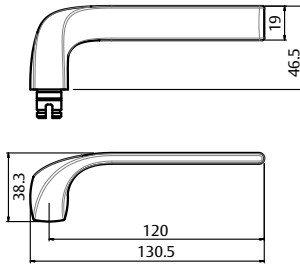

### Lever 153

<b>Length</b>	120mm
<b>Projection</b>	70.6mm

\* Lever is asymmetrically designed and therefore must be handed

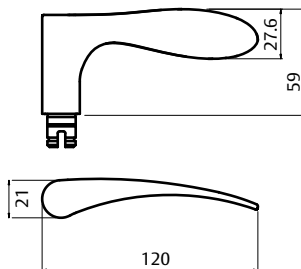

# 200 Series Artefact Square Corner Plate Furniture



The 200 Series Door Furniture Plates measure 162x162mm, and feature square corners. Concealed fixed plates have studs with internal threads located in each corner, visible fixed plates have corresponding countersunk holes and are fixed back to back through the door.

## Application

Designed for use with Lockwood Selector 3770 and Synergy 3570 Series Mortice Locks; Latches and Push and Pull doors.

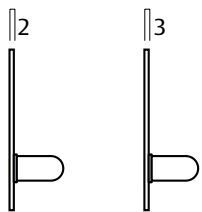
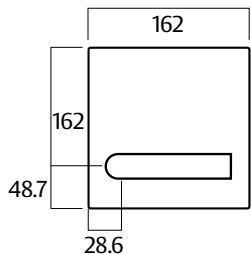

SS/Brass Aluminium

## Product Details

<b>Dimensions</b>	162 x 162 x 3mm - aluminium 162 x 162 x 2mm - stainless steel and brass
<b>Door Thickness</b>	35 to 45mm standard. For doors 45 to 55mm thick, specify long fixing screws SP2000-208.
<b>Standard Finishes</b>	Natural Anodised Aluminium (NT) Satin Stainless Steel (SS)
<b>Fixing</b>	Plates are designed to fit back to back. If outside plate is specified with concealed fixing, then the inside plate must be visible fixed.
<b>Finishes Non Standard</b>	316 Marine Grade (MG) Polished Brass (PB) Polished Stainless Steel (PS) Powdercoat (PC)*
<b>Handing</b>	All plates are handed with the exception of plain plates and pull handles.
<b>Materials</b>	Aluminium, brass and stainless steel

**Note:** When using flush pulls back to back the minimum door thickness is 40mm.

\* Refer to the end of this catalogue for detailed images of all decorative finishes that suit this range.

## Standards and Compliance



Artefact 200 Series has been successfully tested up to 4 hours with a fire rated Lockwood mortice lock on fire door assemblies (depending on type of doorset) in accordance with Australian Standard AS1905.1:2005, Fire Resistant Doorsets.

Artefact 200 Series lever sets have been successfully tested to conform with Level D8 (500,000 cycles) under Australian Standard AS4145.2-2008, Locksets and hardware for doors and windows.

## D8



Anti-Corrosion



Artefact 200 Series includes levers and turns (as shown) that meet the requirements of AS1428.1-2009, Design for access and mobility.

Lockwood Artefact Series is designed, assembled and customised in Australia to suit the requirements of the Australian Market.

# 200 Series Levers and Functions

## Levers and Knob to Suit

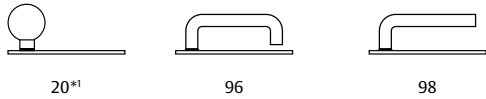

For lever images and dimensions, see page 15.

\*1 Stainless Steel Only

## Pull Handle to Suit

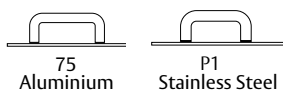

## Plates

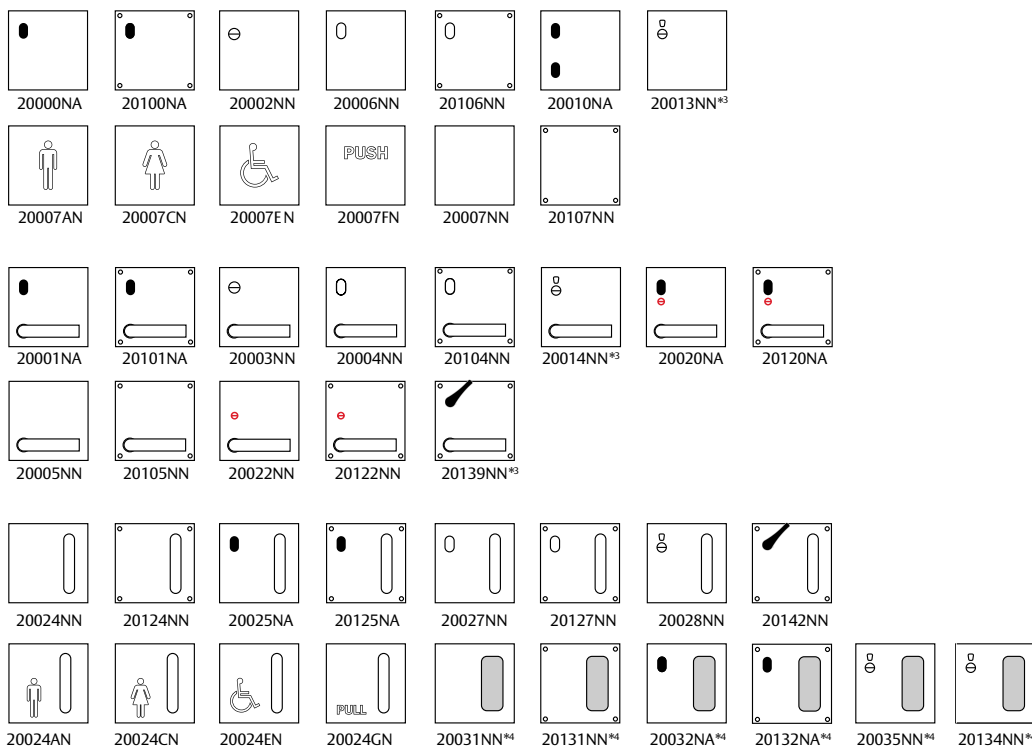

\*3 Replace NN with NS when ordering with 3770 Series

\*4 Recommended for sliding doors only

### Plates and Functions Legend

Cylinder Hole		Emergency Turn		LED	
Turnknob		Disabled Turnknob		Indicating Emergency Turn	

# 202 Series Artefact Round Corner Plate Furniture



The 202 Series Door Furniture is 162mm square with 10mm radius corners. Concealed fixed plates have studs with internal threads located in each corner, visible fixed plates have corresponding countersunk holes and are fixed back to back through the door.

## Application

Designed for use with Lockwood Selector 3770 and Synergy 3570 Series Mortice Locks; Latches and Push and Pull doors.

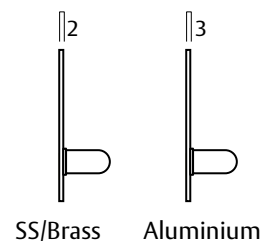
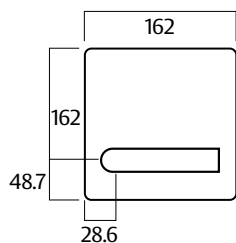

## Product Details

<b>Dimensions</b>	162 x 162 x 3mm - aluminium 162 x 162 x 2mm - stainless steel and brass
<b>Door Thickness</b>	35 to 45mm standard. For doors 45 to 55mm thick, specify long fixing screws SP2000-208.
<b>Fixing</b>	Plates are designed to fit back to back. If outside plate is specified with concealed fixing, then the inside plate must be visible fixed.
<b>Standard Finishes</b>	Natural Anodised Aluminium (NT) Satin Stainless Steel (SS)
<b>Finishes Non Standard</b>	316 Marine Grade (MG) Polished Brass (PB) Polished Stainless Steel (PS) Powdercoat (PC)*
<b>Handing</b>	All plates are handed with the exception of plain plates and pull handles.
<b>Materials</b>	Aluminium, brass and stainless steel

**Note:** When using flush pulls back to back the minimum door thickness is 40mm.

\* Refer to the end of this catalogue for detailed images of all decorative finishes that suit this range.

## Standards and Compliance



Artefact 202 Series has been successfully tested up to 4 hours with a fire rated Lockwood mortice lock on fire door assemblies (depending on type of doorset) in accordance with Australian Standard AS1905.1:2005, Fire Resistant Doorsets.

Artefact 202 Series lever sets have been successfully tested to conform with Level D8 (500,000 cycles) under Australian Standard AS4145.2-2008, Locksets and hardware for doors and windows.

## D8



Anti-Corrosion



Artefact 202 Series includes levers and turns (as shown) that meet the requirements of AS1428.1-2009, Design for access and mobility.

Lockwood Artefact Series is designed, assembled and customised in Australia to suit the requirements of the Australian Market.

# 202 Series Levers and Functions

## Levers and Knob to Suit

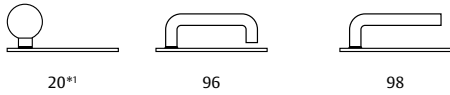

For lever images and dimensions, see page 15.

\*1 Stainless Steel Only

## Pull Handle to Suit

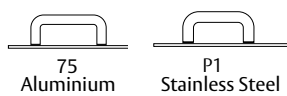

## Plates

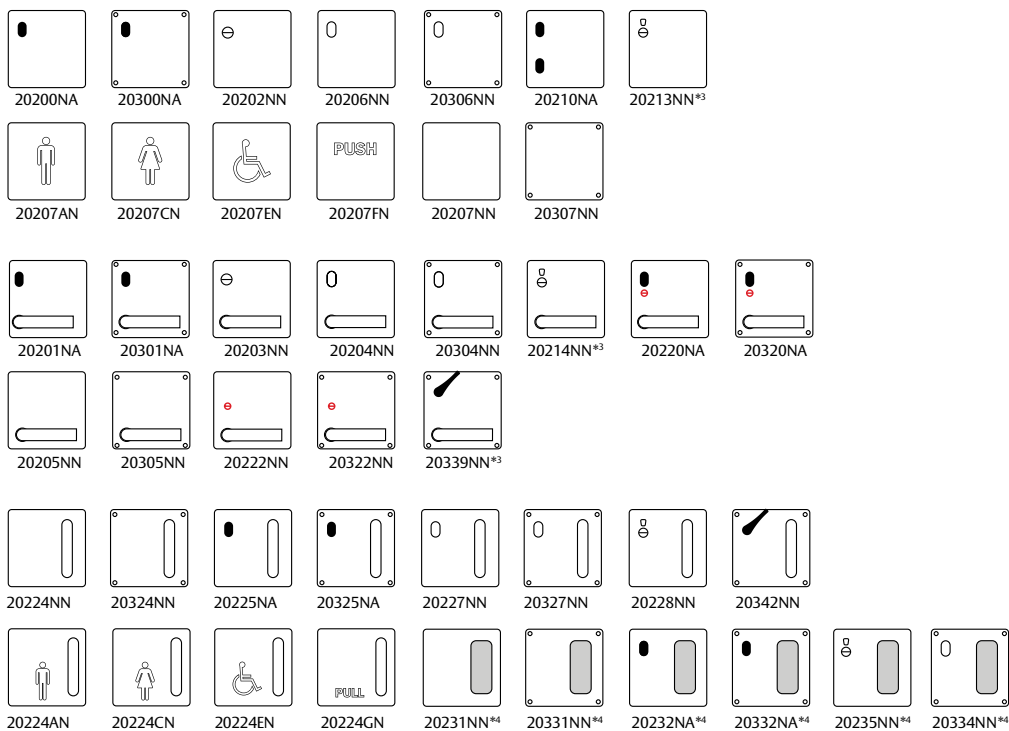

\*3 Replace NN with NS when ordering with 3770 Series

\*4 Recommended for sliding doors only

## Plates and Functions Legend

Cylinder Hole		Emergency Turn		LED	
Turnknob		Disabled Turnknob		Indicating Emergency Turn	

# 200/202 Series Ordering Procedure

When ordering 13, 14, 16 or 39 functions with 3770 series, specify "S" in cylinder type instead of "N".

Sample part number 20001NA/96LSS is made up of several sections. Choose your product by selecting an option from each section.

Plate Type	Plate Function	Engraving	Cylinder Type	Lever/Knob/Pull Handle	Handing	Finish
200	01	N	A	96	L	SS

Plate Type	Plate Function	Engraving - Handed	AS1428.1 Compliant Lever Types	Finish
Exterior Plate (162 x 162) – Square Corners 200	Plain Plate 07 Pull Handle Only 24	A – G Outlined Infill R – X Full Infill	102 111 112 115 116 118 124 131 132 133 142 144 145 155 166 47 59 70 74 76 77 90	<b>Stainless Steel Finishes</b> 316 Marine Grade MG Powdercoat PC Polished Stainless Steel PS Satin Stainless Steel SS
Interior Plate (162 x 162) – Square Corners 201	<b>Plate Function - Handed</b>	Male symbol A R Male text B S Female symbol C T Female text D U Disabled symbol E V Push text F W Pull text G X Unisex symbol H Y No option N	<b>Non Compliant Lever/Knob Types</b> 101 104 106 123 178 97 20	<b>Aluminium Finishes</b> Natural Anodised NT*
Exterior Plate (162 x 162) – Radius Corners 202	Cylinder Only 00 Cylinder & Lever 01 Emergency Turn Only 02 Emergency Turn & Lever 03 Turnknob & Lever 04 Lever Only 05 Turnknob Only 06 Cylinder & Fixed Lever 08 Fixed Lever Only 09 Dual Cylinder 10 Privacy Indicating Emergency Turn Only 13 Privacy Indicating Emergency Turn & Lever 14 Privacy Indicating Turnknob & Lever 16 Cylinder, Lever & LED 20 Cylinder, Fixed Lever & LED 21 Lever & LED 22 Cylinder & LED 23 Pull Handle & Cylinder 25 Pull Handle & Emergency Turn 26 Pull Handle & Turnknob 27 Pull Handle & Privacy Indicating Emergency Turn 28 Pull Handle & Dual Cylinder 30 Flush Pull Only 31 Flush Pull & Cylinder 32 Flush Pull & Emergency Turn 33 Flush Pull & Turnknob 34 Flush Pull & Privacy Indicator Emergency Turn 35 Flush Pull & Dual Cylinder 37 Disabled Turnknob & Lever 39 Pull Handle & Disabled Turnknob 42	For all in-filled engraving, black gloss is the standard.	<b>Handed Levers</b> 41 122 153	<b>Brass Finishes</b> Polished Brass PB
Interior Plate (162 x 162) – Radius Corners 203		<b>Cylinder Type</b> Oval Cylinder – 32mm (H) x 18mm (W) Lockwood 570 Cylinders A Guarded Oval Cylinder – 32mm (H) x 18mm (W) Lockwood 570 Cylinders B No Cylinder Function – Selector S* No Cylinder Function – Synergy N	<b>Pull Handles</b> P1 P1*1 75*2	<b>Refer to the end of this catalogue for detailed images of all decorative finishes from this section.</b>
		*Only applies to 13, 14, 16 and 39 functions	<b>Pull Handles - Horizontal</b> HP1 HP1*1 H75*2	
			Handles are brass unless indicated otherwise *1 = Stainless Steel *2 = Aluminium *3 = 316 Marine Grade ** Lever 65 and 85 not available in PS or PB	
			<b>Handing</b> Left Handed L Right Handed R	

# 212 Series Artefact Oval Plate Furniture



The 212 Series Door Furniture is 162mm long x 50mm wide with radius ends. Concealed fixed plates have studs with internal threads located top and bottom, visible fixed plates have corresponding countersunk holes and are fixed back to back through the door.

## Application

Designed for use with Selector 3770 and Synergy 3570 Series Mortice Locks.

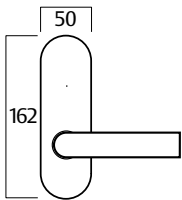

SS/Brass

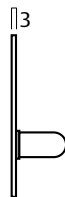

Aluminium

## Product Details

**Dimensions** 162 x 50 x 3mm - aluminium  
162 x 50 x 2mm - stainless steel and brass

**Materials** Aluminium, stainless steel or brass

**Door Thickness** 35 to 45mm standard. For doors 45 to 55mm thick, specify long fixing screws SP2000-208.

**Standard Finishes** Natural Anodised Aluminium (NT)  
Stainless Steel (SS)

**Non Standard Finishes** 316 Marine Grade (MG)  
Polished Brass (PB)  
Polished Stainless Steel (PS)  
Powdercoat (PC)

## Standards and Compliance



Artefact 212 Series has been successfully tested up to 4 hours with a fire rated Lockwood mortice lock on fire door assemblies (depending on type of doorset) in accordance with Australian Standard AS1905.1:2005, Fire Resistant Doorsets.

Artefact 212 Series lever sets have been successfully tested to conform with Level D8 (500,000 cycles) under Australian Standard AS4145.2-2008, Locksets and hardware for doors and windows.

**D8**



Anti-Corrosion.



Artefact 212 Series includes levers and turns (as shown) that meet the requirements of AS1428.1-2009, Design for access and mobility.

Lockwood Artefact Series is designed, assembled and customised in Australia to suit the requirements of the Australian Market.



# 212 Series Levers and Functions

## Levers and Knob to Suit

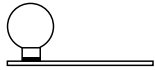

20\*1

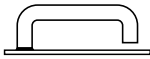

96

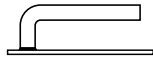

98

For lever images and dimensions, see page 15.

\*1 Stainless Steel Only

## Pull Handle to Suit

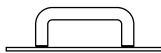

75  
Aluminium

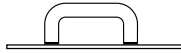

P1  
Stainless Steel

## Plates

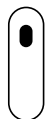

21200NA



21300NA



21202NN

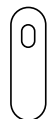

21206NN

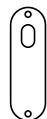

21306NN



21207NN



21307NN

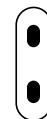

21210NA

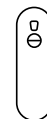

21213NN\*3

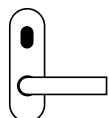

21201NA

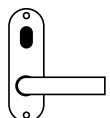

21301NA

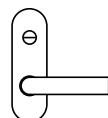

21203NN

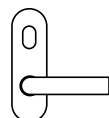

21204NN

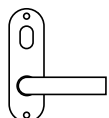

21304NN

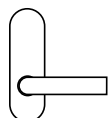

21205NN

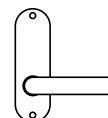

21305NN

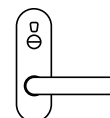

21214NN\*3

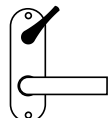

21339NN\*3

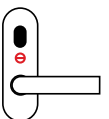

21220NA

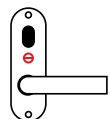

21320NA

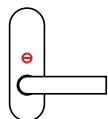

21222NN

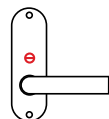

21322NN

\*3 Replace NN with NS when ordering with 3770 Series

### Plates and Functions Legend

Cylinder Hole



Emergency Turn



LED



Turnknob



Disabled Turnknob



Indicating Emergency Turn



# 224 Series Artefact Rectangular Plate Furniture

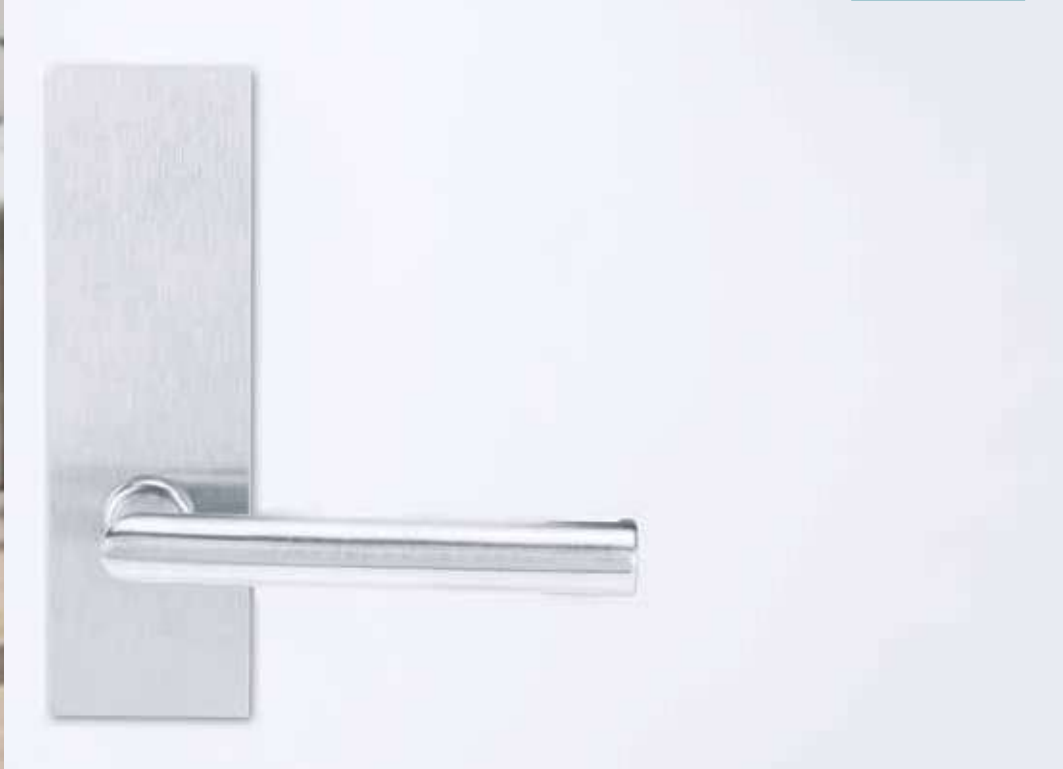

The 224 Series Door Furniture is 162mm long x 50mm wide with square ends. Concealed fixed plates have studs with internal threads located top and bottom, visible fixed plates have corresponding countersunk holes and are fixed back to back through the door.

## Application

Designed for use with Selector 3770 and Synergy 3570 Series Mortice Locks.

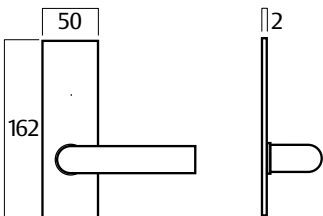

## Product Details

<b>Dimensions</b>	162 x 50 x 2mm - stainless steel
<b>Materials</b>	Stainless steel only
<b>Door Thickness</b>	35mm to 45mm as supplied. Maximum 65mm. For thicker door parts, see page 53.
<b>Finishes</b>	Stainless Steel (SS)

## Standards and Compliance



Artefact 224 Series has been successfully tested up to 4 hours with a fire rated Lockwood mortice lock on fire door assemblies (depending on type of doorset) in accordance with Australian Standard AS1905.1:2005, Fire Resistant Doorsets.

Artefact 224 Series lever sets have been successfully tested to conform with Level D8 (500,000 cycles) under Australian Standard AS4145.2-2008, Locksets and hardware for doors and windows.

## D8



Anti-Corrosion.



Artefact 224 Series includes levers and turns (as shown) that meet the requirements of AS1428.1-2009, Design for access and mobility.

Lockwood Artefact Series is designed, assembled and customised in Australia to suit the requirements of the Australian Market.

# 224 Series Levers and Functions

## Levers and Knob to Suit

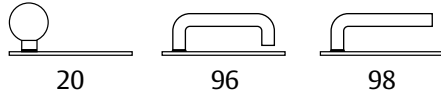

For lever images and dimensions, see page 15.

## Pull Handle to Suit

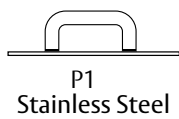

## Plates

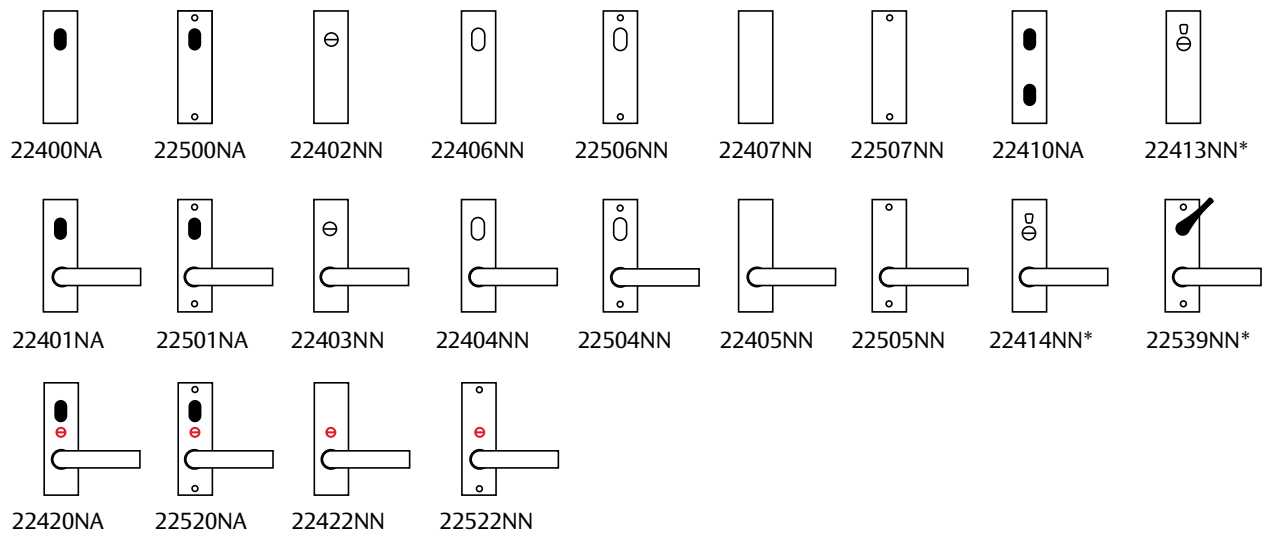

\* Replace NN with NS when ordering with 3770 Series

### Plates and Functions Legend

Cylinder Hole		Emergency Turn		LED	
Turnknob		Disabled Turnknob		Indicating Emergency Turn	

# 212/224 Series Ordering Procedure

When ordering 13, 14, 16 or 39 functions with 3770 series, specify "S" in cylinder type instead of "N".

Sample part number 21201NA/96LSS is made up of several sections. Choose your product by selecting an option from each section.

Plate Type	Plate Function	Engraving	Cylinder Type	Lever/Knob/Pull Handle	Handing	Finish
212	01	N	A	96	L	SS

Plate Type	Plate Function	Engraving - Handed	AS1428.1 Compliant Lever Types	Finish
Exterior Plate (162 x 50) - Oval	Cylinder Only 00	A - G Outlined Infill	102 111 112	<b>Stainless Steel Finishes</b>
Interior Plate (162 x 50) - Oval	Cylinder & Lever 01	R - X Full Infill	115 116 118	
Exterior Plate (162 x 50) - Rectangular	Emergency Turn Only 02	Male symbol A R	124 131 132	316 Marine Grade MG
Interior Plate (162 x 50) - Rectangular	Emergency Turn & Lever 03	Male text B S	133 142 144	Powdercoat PC
	Turnknob & Lever 04	Female symbol C T	145 155 166	Polished Stainless Steel PS
	Lever Only 05	Female text D U	47 59 70	Satin Stainless Steel SS
	Turnknob Only 06	Disabled symbol E V	74 76 77	<b>Aluminium Finishes<sup>4</sup></b>
	Plain Plate 07	Push text F W	78 90	Natural Anodised NT
	Dual Cylinder 10	Pull text G X		<b>Brass Finishes<sup>4</sup></b>
	Privacy Indicating Emergency Turn Only 13	Unisex symbol H Y		Polished Brass PB
	Privacy Indicating Emergency Turn & Lever 14	No option N		
	Privacy Indicating Turnknob & Lever 16	<i>For all in-filled engraving, black gloss is the standard.</i>		
	Cylinder, Lever & LED 20	<b>Cylinder Type</b>		
	Cylinder, Fixed Lever & LED 21	Oval Cylinder - 32mm (H) x 18mm (W) Lockwood 570 Cylinders A		
	Lever & LED 22	Guarded Oval Cylinder - 32mm (H) x 18mm (W) Lockwood 570 Cylinders B		
	Cylinder & LED 23	No Cylinder Function - Selector S*		
	<b>Plate Function - Handed</b>	No Cylinder Function - Synergy N		
	Cylinder & Fixed Lever 08	<i>*Only applies to 13, 14, 16 and 39 functions</i>		
	Fixed Lever Only 09			
	Disabled Turnknob & Lever 39			
			<b>Non Compliant Lever/Knob Types</b>	
			101 104 106	
			123 178 97	
			20	
			<b>Handed Levers</b>	
			41 122 153	
			<b>Angled Levers</b>	
			98A	
			<b>Pull Handles</b>	
			P1 P1*1 75*2	
			<i>Handles are brass unless indicated otherwise</i>	
			<i>*1 = Stainless Steel</i>	
			<i>*2 = Aluminium</i>	
			<i>** Lever 65 and 85 not available in PS or PB</i>	
			<b>Handing</b>	
			Left Handed L	
			Right Handed R	

# Detention Series Square Plate Furniture



A heavy duty plate designed for use in hospitals and detention facilities. Styled for institutional use, this plate has six fixing points to ensure that it is well secured to the door. Plates are designed to be free of ligature points.

## Application

Designed for use with Lockwood Selector 3770 and Synergy 3570 Series Mortice Locks as well as Lockwood 3579 Secure Area Rated Locks.

## Features and Specifications

- Anti-ligature - Knob 21 & 22
- Covers fixing holes from existing Artefact 200 Series Furniture
- Detention furniture turns feature a clutching mechanism that allows the cylinder to retract the bolt even if the turnknob is held from the inside

## Product Details

<b>Dimensions</b>	162mm x 180mm x 2mm: base plate 161mm x 75mm x 3mm: bevelled top plate
<b>Door Thickness*</b>	35mm minimum, 45mm maximum
<b>Finishes</b>	Satin Stainless Steel (SS)
<b>Fixing</b>	Six fixing points 220D series plates have concealed fixings 221D series plates have visible fixings
<b>Handing</b>	All plates are handed except 220D07, 220D24 and 220D31, which are non-handed when ordered without engraving.
<b>Materials</b>	Stainless steel

\*Note: A minimum door thickness of 50mm is required to fit flush pulls back to back.

## Standards and Compliance



**Fire Rated**  
Lockwood Detention Series Plate furniture have been successfully tested up to 2 hours with a fire rated Lockwood mortice lock on fire door assemblies (depending on type of doorset) in accordance with Australian Standard AS1905.1:2005, Fire Resistant Doorsets.

**S3**

High security for maximum protection (AS4145.2:1993).

**D3**

High durability for maximum frequency usage.



Anti-Corrosion

# Detention Series Square Plate Lever/Knobs and Functions

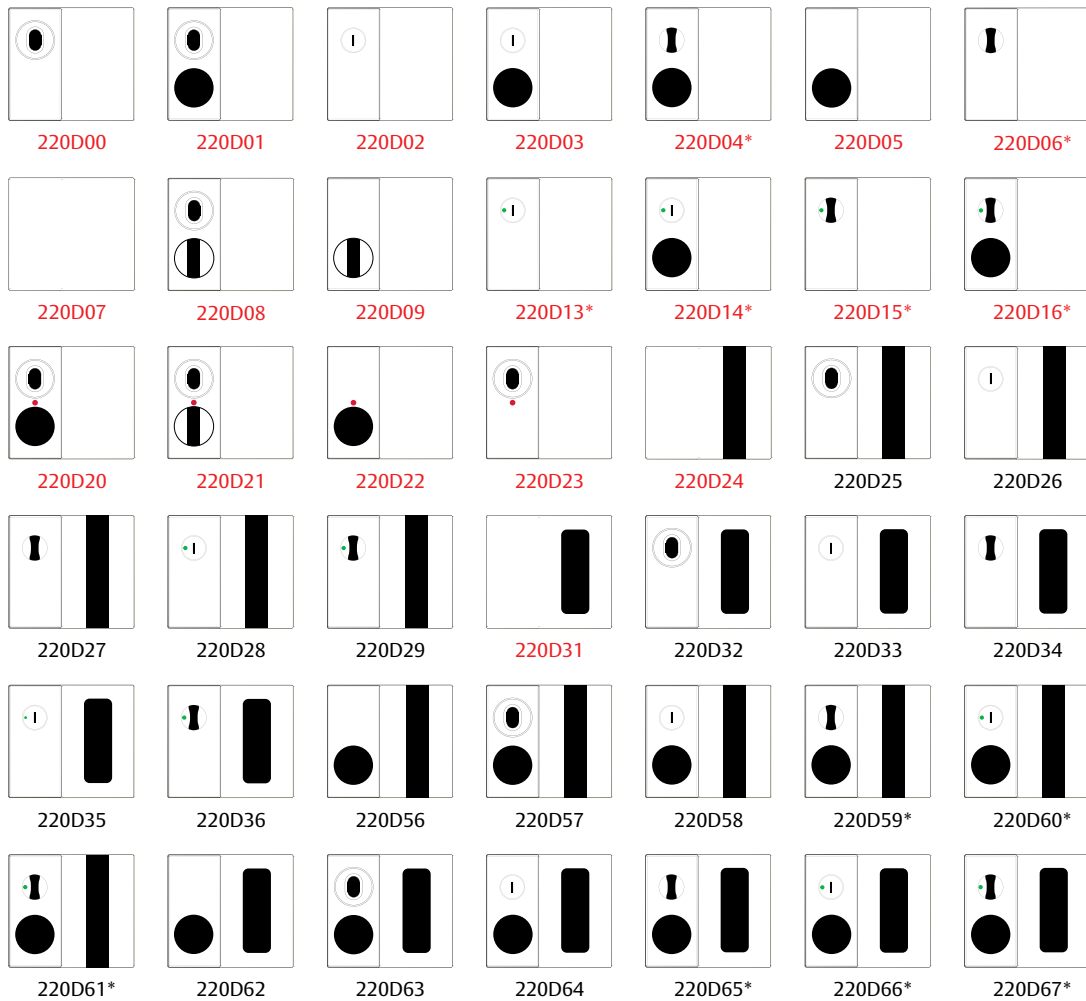

Legend:

	Cylinder Hole		Lever/Knob		Fixed Lever/Knob		Turnknob		Emergency Turn
	Privacy Indicating Turnknob		Privacy Indicating Emergency Turn		LED		Pull Handle		Flush Pull

Cylinder guards must be ordered separately. Only the plate functions shown above in red are available with engraving.

\* Refer to ordering procedure for part number when ordering with 3770 Series

## Lever and Knob Selection

Standard Knob 21

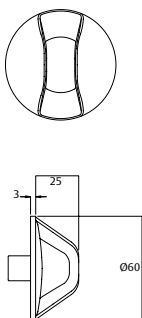

Webbed Knob 22

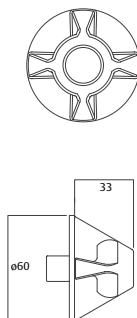

Lever 23

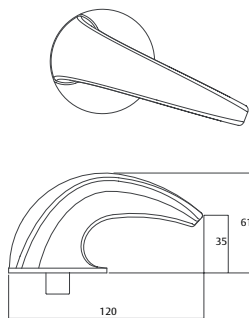

# Detention Series Rectangular Plate Furniture



This smaller plate range has been designed for use in detention facilities such as hospitals where domestic aesthetics are preferred over institutional type styling. Plates are designed to be free of ligature points.

## Application

Designed for use with Lockwood Selector 3770 and Synergy 3570 Series Mortice Locks as well as Lockwood 3579 Secure Area Rated Locks.

## Features and Specifications

- Anti-ligature - Knob 21 & 22
- Covers fixing holes from existing 212 Series Artefact Plates
- Detention furniture turns feature a clutching mechanism that allows the cylinder to retract the bolt even if the turnknob is held from the inside

## Product Details

<b>Dimensions</b>	162mm x 76mm x 2mm: base plate 161mm x 75mm x 3mm: bevelled top plate
<b>Door Thickness</b>	35mm minimum, 45mm maximum
<b>Finishes</b>	Satin Stainless Steel (SS)
<b>Fixing</b>	Four fixing points 222D series plates have concealed fixings 223D series plates have visible fixings
<b>Handing</b>	Only plates with 23 Lever and / or turnknobs are handed
<b>Materials</b>	Stainless steel

## Standards and Compliance



**Fire Rated**  
Lockwood Detention Series Plate furniture have been successfully tested up to 2 hours with a fire rated Lockwood mortice lock on fire door assemblies (depending on type of doorset) in accordance with Australian Standard AS1905.1:2005, Fire Resistant Doorsets.

**S3**

High security for maximum protection (AS4145.2:1993).

**D3**

High durability for maximum frequency usage.



Anti-Corrosion

# Detention Series Rectangular Plate Lever/Knobs & Functions

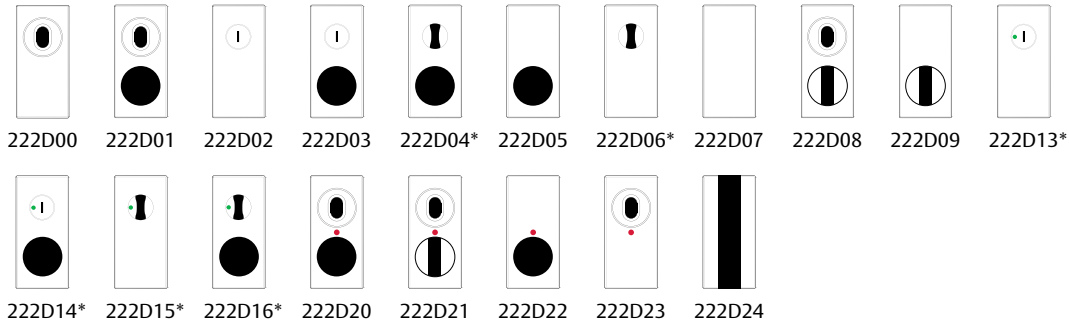

	Cylinder Hole		Lever/Knob		Fixed Lever/Knob		Turnknob		Emergency Turn
	Privacy Indicating Turnknob		Privacy Indicating Emergency Turn		LED		Pull Handle		

\* Refer to ordering procedure for part number when ordering with 3770 Series

## Lever and Knob Selection

Standard Knob 21

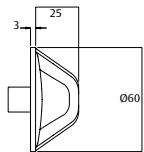
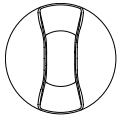

Webbed Knob 22

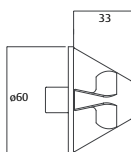

Lever 23

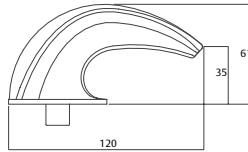
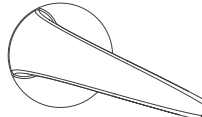



# Detention Series – Knobs and Levers

## Standard Knob 21

Simple yet functional, this knob has soft edges to minimise impact injuries and anti-ligature features that make it suitable for use in detention facilities.

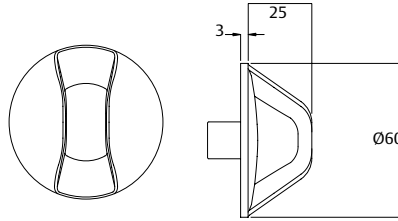

## Webbed Knob 22

The webbed knob combines pleasing aesthetics, comfortable grip and anti-ligature features to provide a solution for any environment.

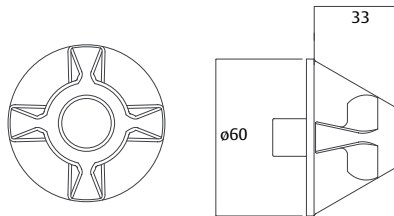

## Lever 23

Ergonomically designed to maximise grip, the detention lever is suitable for use in hospitals and minimum security applications. It caters especially for the elderly or people with arthritic conditions.

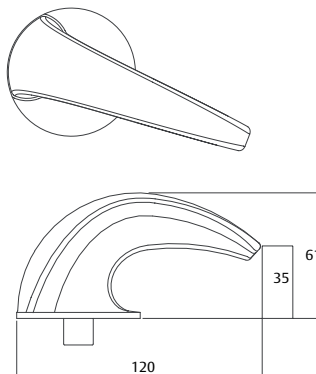

# Detention Series – Turns

Emergency Turn

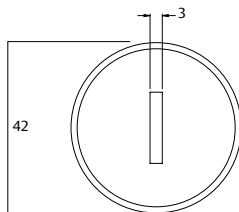

Turnknob

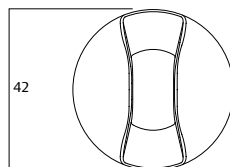

Privacy Indicating  
Emergency Turn

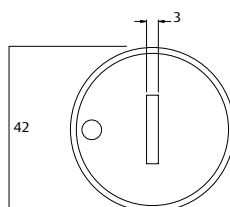

Privacy Indicating Turnknob

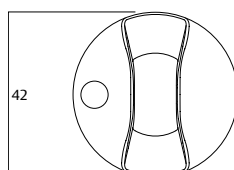

# Detention Series – Pulls

## Flush Pull

The detention flush pull has been designed to maximise grip and eliminate the possibility of hiding objects in the cavity.

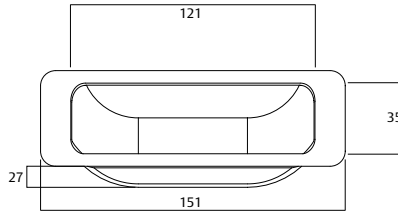

## Standard Pull

The detention pull allows for a firm grip and can be used to open heavy doors. Also designed to be free of hanging points.

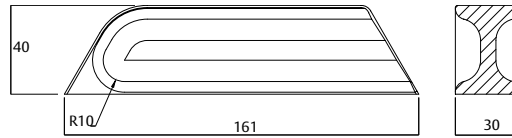

# Detention Series – Accessories

## Cylinder Guards

Part Number	Door Thickness Suitability
-------------	----------------------------

220D00/40SS	Suit doors 35-40mm
-------------	--------------------

220D00/45SS	Suit doors 40-45mm
-------------	--------------------

220D00/50SS	Suit doors 45-50mm
-------------	--------------------

220D00/55SS	Suit doors 50-55mm
-------------	--------------------

220D00/60SS	Suit doors 55-60mm
-------------	--------------------



Cylinder guards must be fitted with any cylinder plate function. Guards are available to suit different door thicknesses.

## Fixing Screws

Part Number	Description	Door Thickness Suitability
-------------	-------------	----------------------------

220D11/45	Torx Anti-tamper Screws	35 - 45mm
-----------	-------------------------	-----------

220D11/55	Torx Anti-tamper Screws	45 - 55mm
-----------	-------------------------	-----------

220D11/65	Torx Anti-tamper Screws	55 - 65mm
-----------	-------------------------	-----------

220D12/45	Standard Screws	35 - 45mm
-----------	-----------------	-----------

220D12/55	Standard Screws	45 - 55mm
-----------	-----------------	-----------

220D12/65	Standard Screws	55 - 65mm
-----------	-----------------	-----------

220D13/50	Snake-eye Screws	35 - 50mm
-----------	------------------	-----------

Torx anti-tamper, snake-eye and standard screws are available in accessory packs to suit different door thicknesses. Only standard screws to suit doors 35mm – 45mm thick are supplied with furniture. Other variations need to be ordered separately using part numbers specified.

All accessory packs contain six screws for the six mounting points per plate.

Screws are a M4 threaded screw with micro-encapsulation to provide resistance against coming loose. Screws are supplied with concealed fix furniture. For screws longer than 65mm, order SP0655MBK (75mm screws).

# Detention Series Square Plate Furniture Ordering Procedure

When ordering 04, 06, 13, 14, 15, 16, 59, 60, 61, 65, 66 or 67 functions with 3770 series, refer to "Cylinder Type" specification for difference in part numbers.

Sample part number 220D01NA/21LSS is made up of several sections. Choose your product by selecting an option from each section.

<b>Plate</b>	<b>Function</b>	<b>Engraving Options</b>	<b>Cylinder Type</b>	<b>Lever/ Knob</b>	<b>Handing</b>	<b>Finish</b>
220	D 01	N	A	21	L	SS

## Plate

Concealed Fix 162mm x 180mm	220
Visible Fix 162mm x 180mm	221

## Function

Plain Plate	07
Pull Handle Only	24
Flush Pull Only	31

## Function - Handed

Cylinder Only	00
Cylinder and Lever/Knob	01
Emergency Turn Only	02
Emergency Turn and Lever	03
Turnknob and Lever/Knob	04
Lever/Knob Only	05
Turnknob Only	06
Cylinder and Fixed Lever/Knob	08
Fixed Lever/Knob Only	09
Privacy Indicating Emergency Turn Only	13
Privacy Indicating Emergency Turn and Lever/Knob	14
Privacy Indicating Turnknob Only	15
Privacy Indicating Turnknob and Lever/Knob	16
Cylinder, Lever/Knob and LED	20
Cylinder, Fixed Lever/Knob and LED	21
Lever/Knob and LED	22
Cylinder and LED	23
Pull Handle and Cylinder	25
Pull Handle and Emergency Turn	26

## Function - Handed cont.

Pull Handle and Turnknob	27
Pull Handle and Privacy Indicating Emergency Turn	28
Pull Handle and Privacy Indicating Turnknob	29
Flush Pull and Cylinder	32
Flush Pull and Emergency Turn	33
Flush Pull and Turnknob	34
Flush Pull and Privacy Indicating Emergency Turn	35
Flush Pull and Privacy Indicating Turnknob	36
Pull Handle and Knob	56
Pull Handle, Cylinder and Knob	57
Pull Handle, Emergency Turn and Knob	58
Pull Handle, Turnknob and Knob	59
Pull Handle, Privacy Indicating Emergency Turn and Knob	60
Pull Handle, Privacy Indicating Turnknob and Knob	61
Flush Pull and Lever/Knob	62
Flush Pull and Cylinder and Lever/Knob	63
Flush Pull and Emergency Turn and Lever/Knob	64
Flush Pull and Turnknob and Lever/Knob	65
Flush Pull and Privacy Indicating Emergency Turn and Lever/Knob	66
Flush Pull and Privacy Indicating Turnknob and Lever/Knob	67

## Engraving Options

Male Symbol	A	R
Male Text	B	S
Female Symbol	C	T
Female Text	D	U
Disabled Symbol	E	V
Push Text	F	W
Pull Text	G	X
Unisex Symbol	H	Y
No Option		N

For all in-filled engraving, black gloss is the standard.  
A-G Outlined Infill  
R-X Full Infill

## Cylinder Type

Australian Oval	A
No Cylinder - Selector	S <sup>1</sup>
No Cylinder - Synergy	N
No Cylinder / No Tailbar - Selector	SN <sup>2</sup>
No Cylinder / No Tailbar - Synergy	NN

<sup>1</sup>Only applies to 04, 06, 13, 14, 15, 16, 59, 60, 61, 65, 66 and 67 functions.

<sup>2</sup>Only applies to 15, 16, 61 and 67 functions.

## Knob

Standard Knob	21
Webbed Knob	22

## Lever - Handed

Lever	23*
-------	-----

## Handing

Left Handed	L
Right Handed	R

\*Lever cannot be used in combination with pull handle

## Finish

Satin Stainless Steel	SS
-----------------------	----

**Note:** Cylinder guards must be ordered with all cylinder function plates. All turnknob functions are supplied with tailbars and clutching mechanisms as standard.

# Detention Series Square Plate Furniture Ordering Procedure

When ordering 04, 06, 13, 14, 15 or 16 functions with 3770 series, refer to “Cylinder Type” specification for difference in part numbers.

Sample part number 222D04NS/21LSS is made up of several sections. Choose your product by selecting an option from each section.

Plate	Function	Engraving Options	Cylinder Type	Lever/ Knob	Handing	Finish	
222	D	04	N	S	21	L	SS

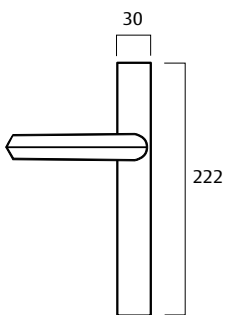

Plate	Engraving Options	Knob	Finish
<b>Concealed Fix</b> 162mm x 76mm <span style="float: right;">222</span>	Male Symbol    A    R Male Text        B    S Female Symbol   C    T Female Text     D    U Disabled Symbol E    V Push Text        F    W Pull Text         G    X Unisex Symbol   H    Y No Option           N	Standard Knob    21 Webbed Knob     22	Satin Stainless Steel    SS
<b>Visible Fix</b> 162mm x 76mm <span style="float: right;">223</span>	For all in-filled engraving, black gloss is the standard. A-G    Outlined Infill R-X    Full Infill	<b>Lever - Handed</b> Lever                    23	<b>Note:</b> Cylinder guards must be ordered with all cylinder function plates. All turnknob functions are supplied with tailbars and clutching mechanisms as standard.
<b>Function</b> Cylinder Only                    00 Cylinder and Lever/Knob      01 Emergency Turn Only         02 Emergency Turn and Lever    03 Lever/Knob Only                05 Plain Plate                        07 Cylinder and Fixed Lever/Knob 08 Fixed Lever/Knob Only        09 Privacy Indicating Emergency Turn Only 13 Privacy Indicating Emergency Turn and Lever/Knob 14 Cylinder, Lever/Knob and LED 20 Cylinder, Fixed Lever/Knob and LED 21 Lever/Knob and LED            22 Cylinder and LED                23	<b>Cylinder Type</b> Australian Oval                A No Cylinder - Selector        S*1 No Cylinder - Synergy        N No Cylinder / No Tailbar - Selector    SN*2 No Cylinder / No Tailbar - Synergy    NN	<b>Handing</b> Left Handed                    L Right Handed                  R	
<b>Function - Handed</b> Turnknob and Lever/Knob    04 Turnknob only                    06 Privacy Indicating Turnknob Only    15 Privacy Indicating Turnknob and Lever/Knob    16	*1 Only applies to 04, 06, 13, 14, 15 and 16 functions. *2 Only applies to 15 and 16 functions.		

# Palladium® Series Door Furniture



The Palladium Series represents the highest standard in residential and semi-commercial door hardware and is brought to you through modern innovative designs, combined with quality manufacturing. A range of lever options is available to enable a common style throughout the home.



## Product Details

<b>Dimensions</b>	222 x 30 x 9mm
<b>Door Thickness</b>	Minimum 32mm - maximum 45mm door thickness.
<b>Finishes</b>	Black (BLK) Polyester Powdercoat (PPC) Satin Chrome Pearl (SP) Satin Chrome Pearl New Zealand (SPNZ)
<b>Fixing</b>	Hole centres at 181mm
<b>Handing</b>	Easy, field selectable handing.
<b>Materials</b>	All plates and levers in the Palladium Series are constructed from solid zinc die-cast.
<b>Screws</b>	M4 Trilobial thread cutting screws Non-threaded screw posts
<b>Keying</b>	Use with Euro profile cylinder
<b>Application</b>	Used with Optimum and Union mortice locks, see table on page 48.

## Standards and Compliance

<b>S3</b>	High security for maximum protection (AS4145.2:2008).
<b>D8</b>	Tested to AS4145.2 2008 for Durability passing D8 - 500,000 cycles.
	Tested to AS4145.2 2008 for Neutral Salt Spray passing C6 Normal Corrosion Resistance - 168 Hours.

## French Door - PLFD Versions

These are used on the fixed door of a set of double doors. The outside furniture has no visible screws, no cylinder hole and the handle is fixed. The inside furniture has visible screw fixings, is used to operate two way locking and has a cylinder hole. This works with the cylinder supplied with the two way lock.

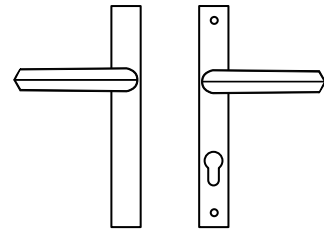

PLFD/85/##

## Passage - PL1 Versions

These are used on the active door of either single or double doors. The outside furniture has no visible screws, no cylinder and the handle operates the latch on the lock. The inside furniture has visible screw fixings, no cylinder hole and the handle operates the latch on the lock.

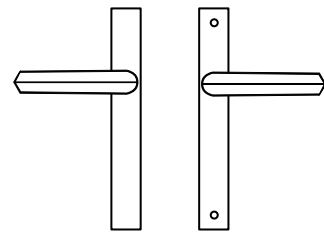

PL1/00/##

## Double Cylinder - PL4 Versions

These are used on the active door of either single or double doors. The outside furniture has no visible screws, a cylinder hole and the handle operates the latch on the lock. The inside furniture has visible screw fixings, a cylinder hole and the handle operates the latch on the lock. Handles operate bolts when used with a compatible multi point lock.

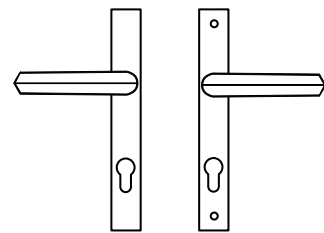

PL4/85/##

## Dummy - PL5 Versions

These are used on the fixed door of a set of double doors. The outside furniture has no visible furniture screws, no cylinder hole and the handle is fixed. The inside furniture has visible screw fixings, no cylinder hole and the handle is fixed.

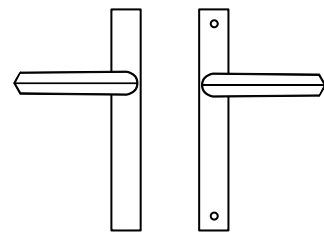

PL5/00/##

## Indicating with Snib - PX4 Versions

These are used on the active door of either single or double doors. The outside furniture has no visible screws, a cylinder hole and the handle operates the latch on the lock. The inside furniture has visible screw fixings, a cylinder hole and the handle operates the latch on the lock. The snib on the inside locks and unlocks the handles and the indicator is red when the cylinder is locked.

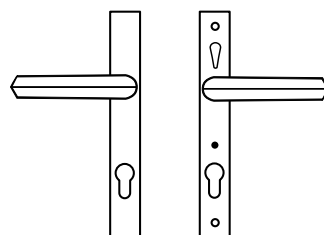

PX4/85/##



# Palladium® Series Door Furniture

## Summit® L1

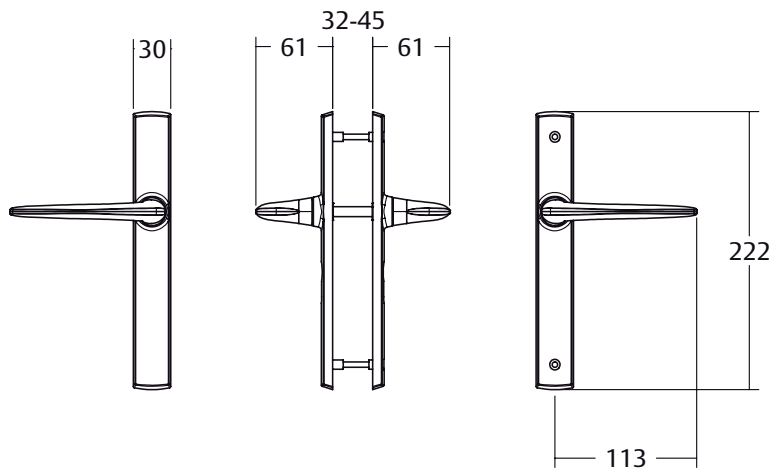

## Aria® #27

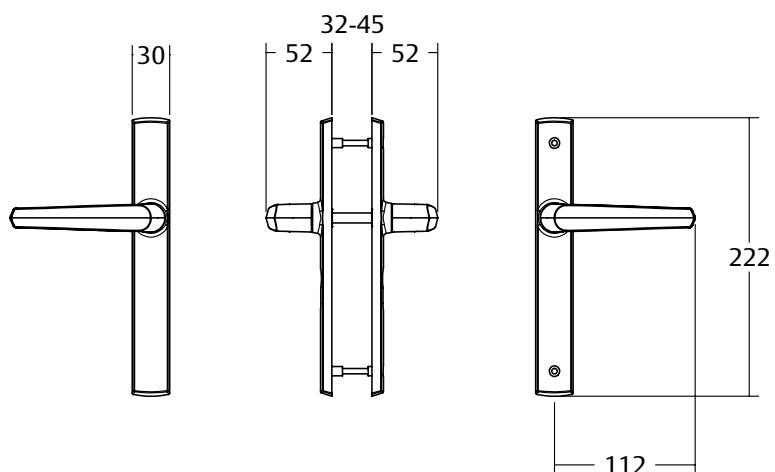

## Acacia® #29

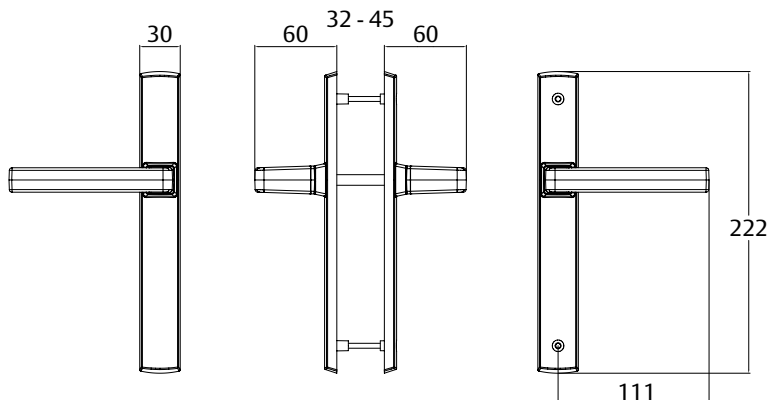

# Palladium® Series Door Furniture

Acacia® #29A

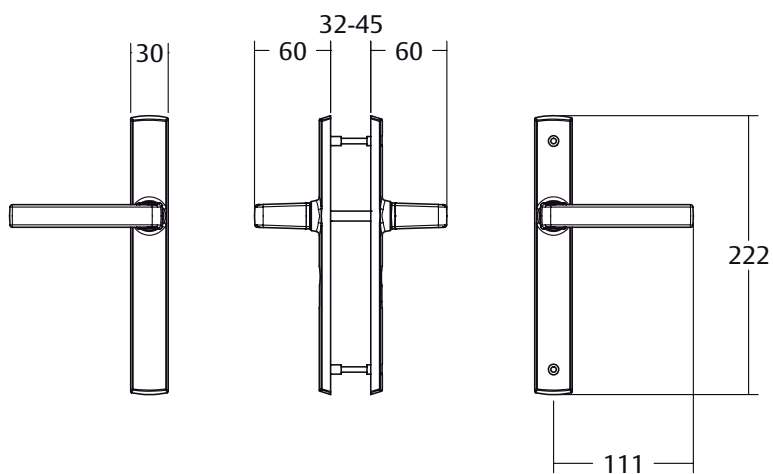

Gidgee® L37

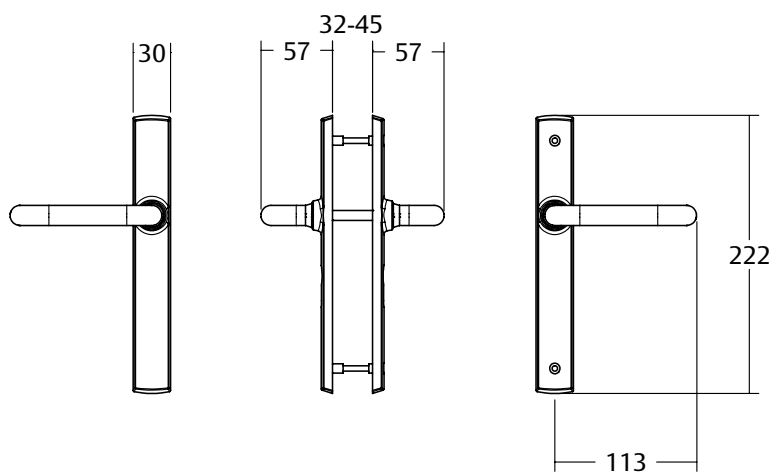

# Diecast Levers

## Acacia® #29

<b>Part Number</b>	#29
<b>Length</b>	122mm
<b>Projection</b>	56mm
<b>Finger clearance</b>	41mm

\*Design Registered Australia/New Zealand.

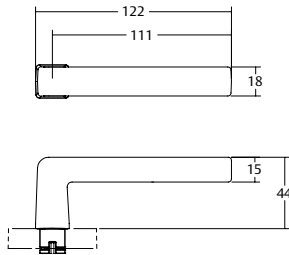

## Acacia® #29A

<b>Part Number</b>	#29
<b>Length</b>	122mm
<b>Projection</b>	56mm
<b>Finger clearance</b>	41mm

\*Design Registered Australia/New Zealand.

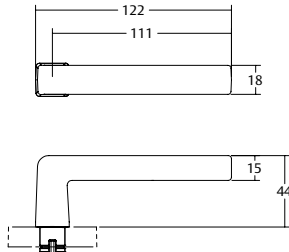

## Aria® S27

<b>Part Number</b>	#27
<b>Length</b>	123mm
<b>Projection</b>	48mm
<b>Finger clearance</b>	36mm

\*Design Registered Australia/New Zealand.

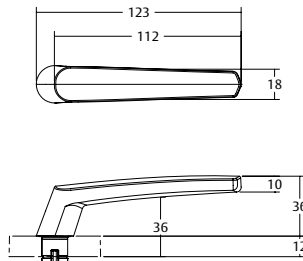

## Gidgee® #37

<b>Part Number</b>	#37
<b>Length</b>	122mm
<b>Projection</b>	53mm
<b>Finger clearance</b>	37mm

\*Design Registered Australia/New Zealand.

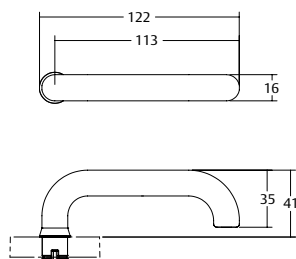

# Diecast Levers

## Summit® #L1

<b>Part Number</b>	#L1
<b>Length</b>	124mm
<b>Projection</b>	57mm
<b>Finger clearance</b>	37mm

\*Design Registered Australia/New Zealand.

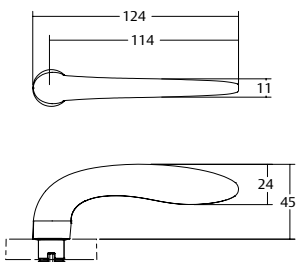

# Palladium® Series Part Numbers

## Double Cylinder Locking Furniture

Lever 1	Part Number	Barcode
Satin Chrome Pearl	PL4/85/L1SP	9311847793781
Black	PL4/85/L1BLK	9311847793811
Satin Chrome Pearl (NZ)	PL4/85/L1SPNZ	9340116012506
Powdercoat	PL4/85/L1PPC	9311847793842

Lever 27	Part Number	Barcode
Satin Chrome Pearl	PL4/85/27SP	9311847798519
Black	PL4/85/27BLK	9311847798458
Satin Chrome Pearl (NZ)	PL4/85/27SPNZ	9311847147355
Powdercoat	PL4/85/27PPC	9311847798496

Lever 29 / 29A	Part Number	Barcode
Satin Chrome Pearl	PL4/85/29ASP	9340116022826
Black	PL4/85/29ABLK	9340116022833
Satin Chrome Pearl (NZ)	PL4/85/29SPNZ	9340116023403
Powdercoat	PL4/85/29PPC	9311847797307

Lever 37	Part Number	Barcode
Satin Chrome Pearl	PL4/85/37SP	9311847798670
Black	PL4/85/37BLK	9311847798618
Satin Chrome Pearl (NZ)	PL4/85/37SPNZ	9340116028750
Powdercoat	PL4/85/37PPC	9311847798656

## French Door Sets

Lever 1	Part Number	Barcode
Satin Chrome Pearl	PLFD/85/L1SP	9311847810839
Black	PLFD/85/L1BLK	9311847810808

Lever 27	Part Number	Barcode
Satin Chrome Pearl	PLFD/85/27SP	9311847810433
Black	PLFD/85/27BLK	9311847810402

## Passage Sets

Lever 27	Part Number	Barcode
Black	PL1/00/27BLK	
Satin Chrome Pearl (NZ)	PL1/00/27SPNZ	
Powdercoat	PL1/00/27PPC	

## Dummy Sets

Lever 27	Part Number	Barcode
Black	PL5/00/27BLK	
Satin Chrome Pearl (NZ)	PL5/00/27SPNZ	
Powdercoat	PL5/00/27PPC	

# Palladium® Series Part Numbers

## Indicating & Snib - Double Cylinder Locking Furniture

Lever 1	Part Number	Barcode
Satin Chrome Pearl	PX4/85/L1SP	9311847105522
Black	PX4/85/L1BLK	9311847105492
Satin Chrome Pearl (NZ)	PX4/85/L1SPNZ	9340116027173
Powdercoat	PX4/85/L1PPC	9311847105515

Lever 27	Part Number	Barcode
Satin Chrome Pearl	PX4/85/27SP	9311847989405
Black	PX4/85/27BLK	9311847989412
Satin Chrome Pearl (NZ)	PX4/85/27SPNZ	9311847119260
Powdercoat	PX4/85/27PPC	9311847105225

Lever 29 / 29A	Part Number	Barcode
Satin Chrome Pearl	PX4/85/29ASP	9340116022802
Black	PX4/85/29ABLK	9340116022819
Satin Chrome Pearl (NZ)	PX4/85/29SPNZ	9340116027180
Powdercoat	PX4/85/29PPC	9311847105355

Lever 37	Part Number	Barcode
Satin Chrome Pearl	PX4/85/37SP	9311847105485
Black	PX4/85/37BLK	9311847105454
Satin Chrome Pearl (NZ)	PX4/85/37SPNZ	9340116028767
Powdercoat	PX4/85/37PPC	9311847105478

# Palladium® Series Part Numbers

Application					
Item Number	Product Name	PL	PX	PLFD	
OP30/1LAN/SS	OPTIMUM 1PT HINGED 30MM BACKSET TP	✓	✗	✗	
OP30/2PTL/SS	OPTIMUM 2PT HINGED 24MM BOLT 30MM BACKSET TP	✓	✓	✗	
OP30/2PTL/SSBL	OPTIMUM 2PT HINGED BEVEL BOLT 24MM BOLT 30MM BACKSET PK=25	✓	✓	✗	
OP30/2PTS/SS	OPTIMUM 2PT HINGED 13MM BOLT 30MM BACKSET TP	✓	✓	✗	
OP30/2PTS/SSBL	OPTIMUM 2PT HINGED BEVEL BOLT 30MM BACKSET PK=25 TP	✓	✓	✗	
OP30/4PTS/SSBL	OPTIMUM 4PT HINGED SHOOT BEVEL BOLT 30MM BACKSET PK=25 TP	✓	✓	✗	
OP30/4RML/SS	OPTIMUM 4PT HINGED REMOTES 24MM BOLT 30MM BACKSET	✓	✓	✗	
OP30/4RML/SSBL	OPTIMUM 4PT HINGED REMOTES 24MM BOLT 30MM B/SET BEVEL BOLT & 2 PACKERS	✓	✓	✗	
OP30/4RMS/SS	OPTIMUM 4PT HINGED REMOTES 13MM BOLT 30MM BACKSET	✓	✓	✗	
OP30/4SBL/SS	OPTIMUM 4PT HINGED SHOOT BOLT 24MM BOLT 30MM BACKSET TP	✓	✓	✗	
OP30/4SBS/SS	OPTIMUM 4PT HINGED SHOOT BOLT 13MM BOLT 30MM BACKSET TP	✓	✓	✗	
OP40/2PTL/SS	OPTIMUM 2PT HINGED 24MM BOLT 40MM BACKSET TP	✓	✓	✗	
OP40/4SBS/SS	OPTIMUM 4PT HINGED SHOOT BOLT 13MM BOLT 40MM BACKSET TP	✓	✓	✗	
OP50/2PTL/SS	OPTIMUM 2PT HINGED 24MM BOLT 50MM BACKSET	✓	✓	✗	
U-X925-SS-M5	UNION 85MM PITCH EURO MORTICE LOCK 25MM BACKSET TP	✓	✗	✗	
U-X930-SS-M5	UNION 85MM PITCH EURO MORTICE LOCK 30MM BACKSET	✓	✗	✗	
U-X935-SS-M5	UNION 85MM PITCH EURO MORTICE LOCK 35MM BACKSET	✓	✗	✗	
P84318NRA	TBL FR DR NO FURN/CYL *NO RODS	✗	✗	✓	

**Note:** For further information, please refer to the Euro Profile Mortice Locks catalogue.

# Brass Furniture Thicker Door Accessories

Lockwood Brass Door Furniture is suitable for use across a wide range of door thicknesses. In certain applications longer screws, spindles and turnknob tailbars may be required.

## Screws

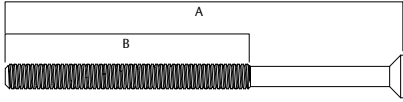

### Screws

Part Number	Pack Size	Length (A)	Threaded Length (B)	Door Thickness	
				Min	Max
SPA20-V3 NSS	20	65mm	40mm	32mm	50mm
SP0655MBK	10	75mm	40mm	42mm	60mm
SP1800-608ZP	10	120mm	75mm	52mm	105mm
SP1800-208SS	10	215mm	125mm	97mm	200mm

**Note:** Item shown is red is the standard screw that is supplied with furniture.

Consideration should be given to screw finish on furniture platforms featuring visible fixing.

## Mortice Lock Spindles

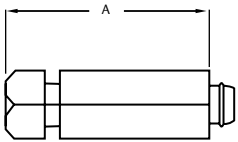

### Mortice Lock Spindles

Part Number	Pack Size	Length (A)	Door Thickness	
			Min	Max
SP3570-5018	10	33mm	35mm	50mm
SP3570-5228	10	45mm	50mm	75mm
SP3570-5238	1	58mm	75mm	100mm

In thicker door scenarios when Lockwood Brass Door Furniture is used with Lockwood Selector or Synergy Series Mortice Locks, longer spindles may be required.

## Turnknob Tailbars

The door thickness range for a turnknob tailbar will depend on whether the turn is in a cylinder and turn configuration or a privacy (turn and turn) configuration

### Turnknob Tailbars

Part Number	Pack Size	Length
SP571-38ZP	10	47mm
SP571-138ZP	1	98mm

**Note:** Item shown is red is the standard tailbar that is supplied with furniture.



# Lockwood Door Furniture Handing Convention

Applicable for All Handed Furniture

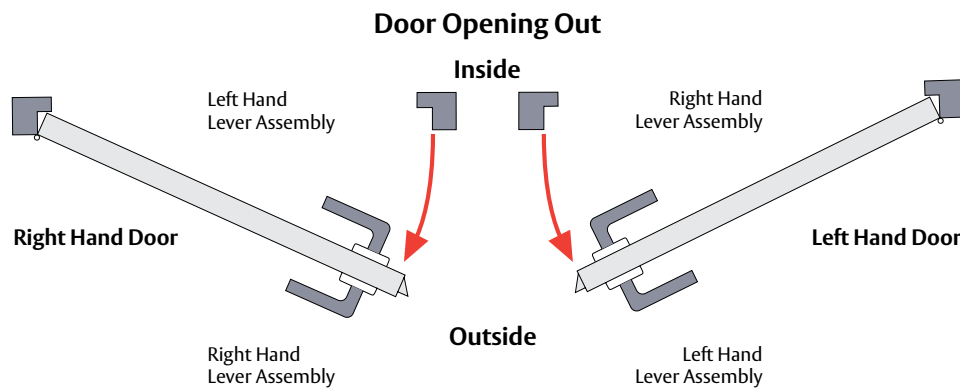
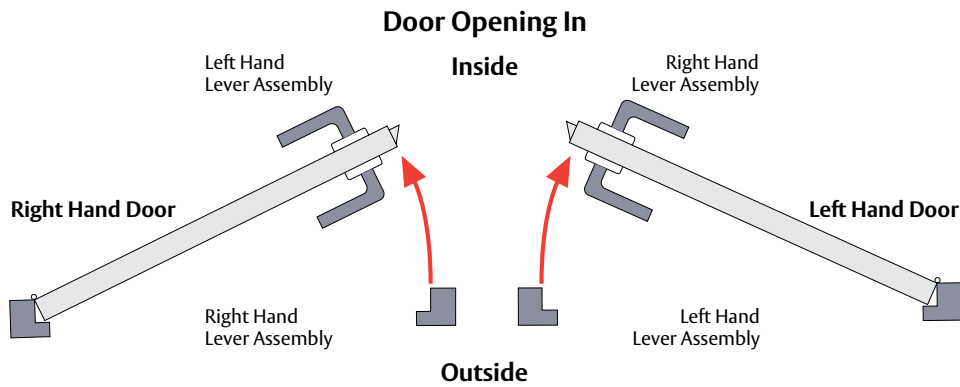

# Metal Finishes

For Metal Finish sample refer to code under each image.



Antique Copper (AC)  
Sample Code: FIN-SAMPLEAC\*



Architectural Bronze Unlacquered (AU)  
Sample Code: FIN-SAMPLEAU\*

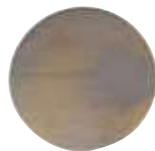

Oil Rubbed Bronze (ORB)  
Sample Code: FIN-SAMPLEORB\*

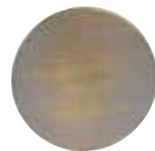

Aged Brass (AG)  
Sample Code: FIN-SAMPLEAG\*



Architectural Bronze (AZ)  
Sample Code: FIN-SAMPLEAZ\*\*



Polished Brass (PB)  
Sample Code: FIN-SAMPLEPB\*\*



Satin Brass (SB)  
Sample Code: FIN-SAMPLESB\*\*



Polished Brass Unlacquered (BU)  
Sample Code: FIN-SAMPLEBU\*



Satin Brass Unlacquered (SBU)  
Sample Code: FIN-SAMPLESBU\*

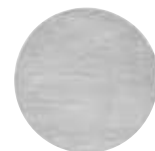

Satin Chrome Plating (SC)  
Sample Code: FIN-SAMPLESC



Chrome Plating (CP)  
Sample Code: FIN-SAMPLECP



Stainless Steel (SS)  
Sample Code: FIN-SAMPLESS



Polished Stainless Steel (PS)  
Sample Code: FIN-SAMPLEPS



Natural Anodized Aluminium (NT)  
Sample Code: FIN-SAMPLENT

**NOTE:** Not all decorative finishes apply to every Lockwood product. Refer to the table at the end of this document for specific decorative finishes applicable per series.

\*Unlacquered Metal Finish. This finish will naturally age and its appearance will change over time according to the environment and use it is exposed to. For more information on the aging effect of a particular finish contact your ASSA ABLOY representative.

\*\*Finish is protected by a top clear lacquer.

**Disclaimer:** Product Colours displayed in this catalogue have been matched to indoor viewing and colour appearance may vary according to light source and medium and as such should be used as indicative only. As actual colour on the end product may vary, always confirm your colour choice with production line prepared samples from your ASSA ABLOY representative for final colour approval. For warranty terms and conditions on Lockwood Products and its finishes, please visit [www.lockweb.com.au](http://www.lockweb.com.au) or call 1300WARRANTY

# Dulux Powdercoat Finishes

For Powdercoat Finish sample order code:

**FIN-SAMPLEPC** specify the desired color from the images below when placing order.

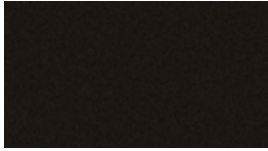

Dulux Duratec Eternity  
Eternity Charcoal Pearl  
Satin



Dulux Electro  
Black Ace  
Flat



Dulux Electro  
Dark Bronze  
Flat



Dulux Electro  
Medium Bronze  
Flat

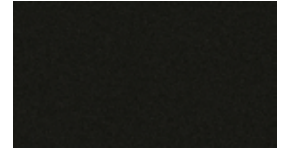

Dulux Precious  
Charcoal Metallic Pearl  
Gloss



Dulux Precious  
Citi Pearl  
Matt



Dulux Precious  
Natural Pearl  
Matt



Dulux Precious  
Nickel Pearl  
Matt



Dulux Precious  
Sharp Silver Kinetic® Pearl  
Satin



Dulux Precious  
Silver Kinetic® Pearl  
Satin

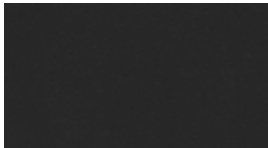

Dulux Surreal Effects Mannex  
Mannex Black  
Effect



Dulux Surreal Effects Scylla  
Red Brown Scylla  
Effect

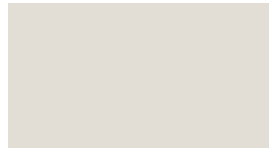

Dulux Duralloy  
Shoji White  
Satin

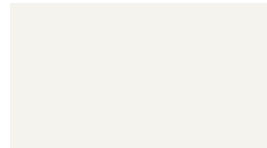

Dulux Alphatec  
White  
Matt

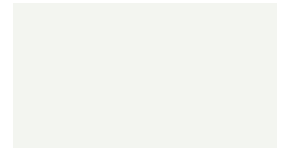

Dulux Duralloy  
White  
Satin



Dulux Duralloy  
Black  
Gloss



Dulux Duralloy  
Monument®  
Satin

CB



Dulux Duralloy  
Black (C/B Night Sky®)  
Satin

CB



Dulux Duralloy  
Dune®  
Satin

CB



Dulux Duralloy  
Woodland Grey®  
Satin

CB

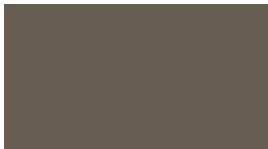

Dulux Duralloy  
Jasper®  
Satin

CB



Dulux Duralloy  
Monument®  
Matt

CB



Dulux Duralloy  
Deep Ocean®  
Satin

CB



Dulux Duralloy  
Woodland Grey®  
Matt

CB



Dulux Duralloy  
APO Grey  
Satin

**NOTE:** Not all Powdercoat Finishes apply to every Lockwood product. Refer to the notes at the end of this document for specific decorative finishes applicable per series.

**CB** Colorbond and the Colorbond colour names are registered trademarks of Bluescope Steel Limited



We recommend and use Dulux Powders

**Disclaimer:** Dulux, Duralloy, Anotec, Silver Kinetic, are registered trade marks of DuluxGroup (Australia) Pty Ltd. Monument, Night Sky, Dune, Woodland Grey, Jasper, Deep Ocean, Surfist, Pale Eucalypt, Paperbark, are registered trademarks of Bluescope Steel Limited. Product Colours displayed in this catalogue have been matched to indoor viewing and colour appearance may vary according to light source and medium and as such should be used as indicative only. As actual colour on the end product may vary, always confirm your colour choice with production line prepared samples from your ASSA ABLOY representative for final colour approval. For warranty terms and conditions on Lockwood Products and its finishes, please visit [www.lockweb.com.au](http://www.lockweb.com.au) or call 1300WARRANTY

# Dulux Powdercoat Finishes

For Powdercoat Finish sample order code:

**FIN-SAMPLEPC** specify the desired color from the images below when placing order.

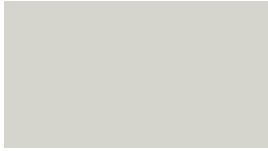

Dulux Duralloy  
Surfmist®  
Matt

CB

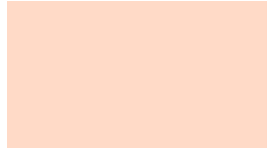

Dulux Duralloy  
Anotec® Off White  
Matt



Dulux Duralloy  
Anotec® Mid Bronze  
Matt



Dulux Duralloy  
Dune®  
Matt

CB

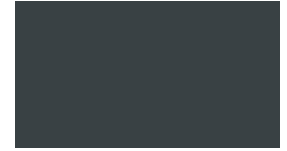

Dulux Duralloy  
Anotec® Dark Grey  
Matt

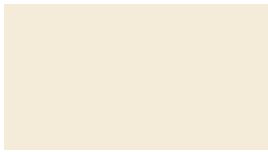

Dulux Duralloy  
White Birch  
Gloss



Dulux Duralloy  
Stone Beige  
Matt



Dulux Duralloy  
Notre Dame  
Gloss



Dulux Duralloy  
Pale Eucalypt®  
Satin

CB



Dulux Duralloy  
Magnolia  
Gloss



Dulux Duralloy  
Doeskin  
Satin



Dulux Duralloy  
Paperbark®  
Satin

CB



Dulux Duralloy  
Classic Hawthorn Green  
Gloss



Dulux Duralloy  
Primrose  
Gloss



Dulux Duralloy  
Black (C/B Night Sky®)  
Matt

CB

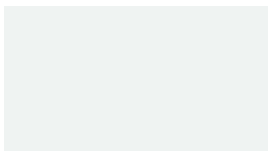

Dulux Duralloy  
Pearl White  
Gloss

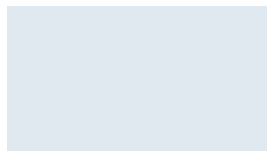

Dulux Duralloy  
Bright White  
Gloss



Dulux Precious  
Mahogany Gloss Pearl



Dulux Surreal Effects  
Black Gold  
Gloss



Dulux Duralloy  
Charcoal Lustre  
Matt

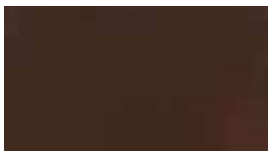

Dulux Alphatec  
Ranch Brown  
Satin



Dulux Duralloy  
Coffee  
Satin

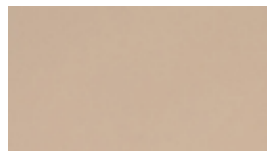

Dulux Duralloy  
Pottery  
Satin

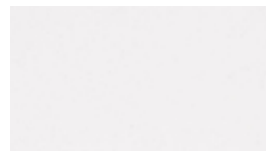

Dulux Duralloy  
White Lustre  
Matt

**NOTE:** Not all Powdercoat Finishes apply to every Lockwood product. Refer to the notes at the end of this document for specific decorative finishes applicable per series.

CB Colorbond and the Colorbond colour names are registered trademarks of Bluescope Steel Limited



We recommend and use Dulux Powders

**Disclaimer:** Dulux, Duralloy, Anotec, Silver Kinetic, are registered trade marks of DuluxGroup (Australia) Pty Ltd. Monument, Night Sky, Dune, Woodland Grey, Jasper, Deep Ocean, Surfist, Pale Eucalypt, Paperbark, are registered trademarks of Bluescope Steel Limited. Product Colours displayed in this catalogue have been matched to indoor viewing and colour appearance may vary according to light source and medium and as such should be used as indicative only. As actual colour on the end product may vary, always confirm your colour choice with production line prepared samples from your ASSA ABLOY representative for final colour approval. For warranty terms and conditions on Lockwood Products and its finishes, please visit [www.lockweb.com.au](http://www.lockweb.com.au) or call 1300WARRANTY

# Decorative Finishes Per Series

## Powdercoat Finishes

**Rose Door Handles:** Robert Watson, 1220, 1420, 1360, 1370, 260, 260SQ

**Plate Door Handles:** 1800, 2800, 4800, 5800, 200, 202, 212, 224

**Push/Pull Plates:** 218/219, 206/207, 208/209, 214/215, 216/217, 184, 185

## Metal Finishes

Use table below as a reference for the applicable finish to each Lockwood Series.

Refer to the series catalogue for specific detailed information.

Reference Table									
	Brass Series Rose Door Handles 1220, 1420, 1360, 1370	Brass Series Plate Door Handles 1800, 2800, 4800, 5800	Artefact Series Rose Door Handles 260	Artefact Series Rose Door Handles 260SQ	Artefact Series Plate Door Handles 200, 202,	Artefact Series Plate Door Handles 212, 224	Push/Pull Plate Series 184, 185	Push/Pull Plate Series 214/215, 216/217, 218/219	Push/Pull Plate Series 206/207, 208/209
Antique Copper (AC)	✓	✓	✓	✗	✓	✗	✓	✓	✗
Architectural Bronze Unlacquered (AU)	✓	✓	✓	✗	✓	✗	✓	✓	✗
Oil Rubbed Bronze (ORB)	✓	✓	✓	✗	✓	✗	✓	✓	✗
Aged Brass (AG)	✓	✓	✓	✗	✓	✗	✓	✓	✗
Architectural Bronze (AZ)	✓	✓	✓	✗	✓	✗	✓	✓	✗
Polished Brass (PB)	✓	✓	✓	✗	✓	✗	✓	✓	✗
Satin Brass (SB)	✓	✓	✓	✗	✓	✗	✓	✓	✗
Polished Brass Unlacquered (BU)	✓	✓	✓	✗	✓	✗	✓	✓	✗
Satin Brass Unlacquered (SBU)	✓	✓	✓	✗	✓	✗	✓	✓	✗
Satin Chrome Plating (SC)	✓	✓	✗	✗	✗	✗	✓	✗	✗
Chrome Plating (CP)	✓	✓	✗	✗	✗	✗	✓	✗	✗
Stainless Steel (SS)	✗	✗	✓	✓	✓	✓	✗	✓	✓
Polished Stainless Steel (PS)	✗	✗	✓	✗	✓	✓	✗	✓	✓
Marine Grade Stainless Steel (MG)	✗	✗	✓	✗	✓	✓	✗	✓	✓
Natural Anodised Aluminium (NT)	✗	✗	✓	✗	✓	✓	✗	✗	✗

**Disclaimer:** Product Colours displayed in this catalogue have been matched to indoor viewing and colour appearance may vary according to light source and medium and as such should be used as indicative only. As actual colour on the end product may vary, always confirm your colour choice with production line prepared samples from your ASSA ABLOY representative for final colour approval. For warranty terms and conditions on Lockwood Products and its finishes, please visit [www.lockweb.com.au](http://www.lockweb.com.au) or call 1300WARRANTY



**ASSA ABLOY**

**Lockwood** is the leading brand in the Australian locking industry. With an established reputation for high quality products, this iconic brand provides a wide range of locking solutions to residential housing, commercial, semi-commercial, building and industrial application markets. Lockwood is supported by an extensive distribution and after-sales support network. Our customers include retailers, architects, trade and industrial personnel, locksmiths and security dealers.

**ASSA ABLOY** is the global leader in door opening solutions, dedicated to satisfying end-user needs for security, safety and convenience.

**ASSA ABLOY** is represented in all major regions, in both mature and emerging markets, with leading positions in Australia, Europe and North America.

**25YEAR  
MECHANICAL  
WARRANTY**

### The Lockwood 25 Year Mechanical Warranty

Our belief that we manufacture the finest premium products available in today's market place is backed by the Lockwood 25 Year Mechanical Warranty, ensuring that Lockwood continues to keep Australians safe by delivering security and peace of mind.

For warranty terms and conditions, please visit [www.lockweb.com.au](http://www.lockweb.com.au) or call **1300WARRANTY**

**ASSA ABLOY Australia Pty Ltd**  
235 Huntingdale Road  
Oakleigh, Victoria, 3166  
Australia

**1300 LOCK UP (1300 562 587)**  
[lockweb.com.au](http://lockweb.com.au)

**ASSA ABLOY New Zealand Ltd**  
6 Armstrong Road  
Albany, Auckland, 0632  
New Zealand

[info.nz@assaabloy.com](mailto:info.nz@assaabloy.com)  
Telephone +64 9415 7111  
[assaabloy.co.nz](http://assaabloy.co.nz)



*Purchase Lockwood products through Access Hardware to earn 1 Qantas Point per \$1 spent for your business\*. Find out more by calling Access Hardware customer service on 1800 555 600 or visit [accesshardware.com.au](http://accesshardware.com.au)*

\*A business must be a Qantas Business Rewards member to earn Qantas points for business. Membership and Qantas Points are subject to Qantas Business Rewards Terms and Conditions at [qantasbusinessrewards.com/terms](http://qantasbusinessrewards.com/terms) and Access Hardware Terms and Conditions at [www.accesshardware.com.au/qbr](http://www.accesshardware.com.au/qbr)

Customer Service  
**1800 555 600**

Locksmithing  
**1800 555 700**

#### Disclaimer

Whilst every effort has been made to ensure that the information (including product images and drawings) contained in this brochure is accurate at the time of publication, ASSA ABLOY Australia Pty Limited ("ASSA ABLOY") recommends that you consult ASSA ABLOY or its agents prior to placing an order to ascertain current information on specific products, as ASSA ABLOY reserves the right to make changes without notice. ASSA ABLOY will not be liable for any injury, loss or damage whatsoever, arising from any errors or omissions in the information contained in the brochure or arising from the use or application of the information contained herein. © 2020 copyright by ASSA ABLOY All rights reserved

