

Selector[®] 3700 Series Mortice Locks



We take the worry out of
protecting what's valuable to you.
Lockwood: *no worries*[®]

LOCKWOOD

ASSA ABLOY

25YEAR

**MECHANICAL
WARRANTY**

www.lockweb.com.au

Contents



Selector® 3770 MkII Series

Standard Backset

page 5



Selector® 3770 MkII

Mortice Nightlatches

page 9



Selector® 3772 MkII

Escape Locks

page 12



Selector® 3774 MkII

Passage Latch

page 18



Selector® 3774 MkII

Combination Locks

page 21



Selector® 3777 MkII

Dual Entry Locks

page 26



Selector® Privacy MkII

Privacy Locks

page 29



Selector® 3772 MkII DX Digital

DX Digital Mortice Locks

page 33



Selector® 3772 MkII DX Digital

Key Override DX Digital Mortice Locks

page 36



Selector® 3770 Series Accessories

Standard Backset Mortice Lock Accessories

page 39



Selector® 3770 MkII Series Function Guides

Function Chart, Synergy® Conversion Chart and Functioning Matrix

page 45



Selector® 3780 MkI Series

Short Backset Mortice Locks

page 49

Contents



Selector® 3782

Short Backset Escape Locks

page 52



Selector® 3784

Short Backset Combination Locks

page 57



Selector® 3787

Short Backset Dual Entry Locks

page 62



Selector® 3782 DX Digital

Short Backset DX Digital Mortice Locks

page 65



Selector® 3782 DX Digital

Short Backset Key Override DX Digital Series

page 68



Selector® 3780 Series Accessories

Short Backset Mortice Lock Accessories

page 71



Selector® 3780 Series Function Guides

Function Chart, Synergy Conversion Chart and Functioning Matrix

page 78



Selector[®] 3770 MkII Series Mortice Locks

Selector® 3770 MkII Series Cylinder Mortice Locks

Advantages

In the spirit of continuous improvement, the Selector 3770 Series MkII Mortice lock range is the latest step in the evolution of the Selector mortice lock. This upgrade allows for more applications of the Selector mortice lock such as use with the Fluid Panic Exit Device. And while the both the Selector Series mortice locks (MkI) and the new MkII perform particularly well against the Australian Standard, the MkII is a further improvement over MkI when it comes to the list of non-standard tests which ASSA ABLOY Australia performs on these locks. The non-standard list of tests reflect real world treatment of mortice locks over and above that contained in the Australian Standard and are based on the extensive experience ASSA ABLOY Opening Solutions has with mortice locks. For example, we have tested applying loads on bolts while the latch is being retracted. ASSA ABLOY Opening Solutions conducts tests beyond the Australia Standard up to the point of destruction to identify failure modes, to prevent access under these conditions.

Difference

The embossed dot on the underside of the auxiliary bolt of the Selector MkII for the 60mm version. This will identify the installed Selector mortice lock as a MkII lock.

The main bolt hole shape in the faceplate has changed for MkII. This can be seen when the cover plate is removed. This is used to identify the installed MkII mortice lock for the 89mm and 127mm backset versions.

Application

A comprehensive range of cylinder mortice locks suitable for heavy duty use in industrial and commercial buildings, institutions, clubs, schools, hospitals, hotels and similar buildings.

Benefits

- Easy red/green function setting
- All lock settings are made from under the faceplate allowing for simple in-door configuration
- Standard primary locks include anti-lockout and holdback capabilities
- Improved cylinder functions including lock/unlock and retract latch as standard
- Through-fixing of rose furniture turnknobs and escutcheons
- Reduced range of cylinder cams and turn adaptors relative to other commonly available commercial cylinder mortice locks

Features and Specifications

The Australian designed and made Selector® 3770 Series Cylinder Mortice Locks are made from quality materials to meet high durability and strength requirements.

Case and Faceplates

- High purity zinc alloy material cases with stainless steel chassis plates. Stainless steel faceplates provided as standard.
- Brass faceplates available for alternative finishes

Backset

- 60mm standard backset
- Extended backsets 89mm and 127mm are available - Refer to Function Matrix (Page 43)

Latch Bolts

- Latch bolts are made with stainless steel, 15mm in size
- Deadlatching is achieved by an auxiliary stainless steel latch bolt
- Reversible for both left and right hand doors, opening in or opening out whilst lock is in door
- Electric Strike compatibility
- Separate auxiliary bolt moves into lock case simultaneously with latch bolt
- Radius bolt provides greater deadlatch throw and smoother closing action

Cylinder Retaining Pin

Hard-drawn spring steel wire, corrosion protected.

Door Thickness

- 32mm to 50mm

Components to facilitate use on thicker doors are available on application.

Door Clearance

To ensure correct functioning of the deadlatching mechanism and security for all locks, the clearance between the door and the frame should be 3mm. The deadlatching will operate up to 7mm door clearance however, door clearances over 5mm are not recommended.

Aluminium Doors

Specify Selector® 3772-AFKIT for aluminium door fixing kit to convert a timber fix lock to suit aluminium door fixing. The aluminium door fixing kit comes with a 156mm by 25mm radius corner faceplate common to other aluminium door locks.

Security

All Selector® 3770 Series Cylinder Mortice Locks conform with Level S7 (Physical Security) Australian Lock Standard (AS-4145.2-2008). Conforms to Level S8 (Physical Security) when fitted with door furniture and anti-drill cylinder.

Durability

All Selector® 3770 Series Cylinder Mortice Locks conform with Level D8 (Durability) Australian Lock Standard (AS 4145.2-2008).

Fire Rating

All Selector® 3770 Series Mortice Locks have been successfully tested up to 4 hours (depending on type of doorset) on fire door assemblies in accordance with Australian Standard AS 1905.1-2005, Part 1: Fire Resistant Doorsets*.

Selector® 3770 MkII Series Cylinder Mortice Locks

Anti-Corrosion

All Selector® 3770 Series Cylinder Mortice Locks conform with Level C6 (168 hours) Australian Lock Standard (AS4145.2-2008).

Cylinder

Requires standard Lockwood oval shaped brass cylinders and brass barrels. Lockwood cylinders include bump resistant five pin tumbler mechanism.

Functions require the use of different cams and adaptors.

Keying

Restricted Special Keying

Lockwood locks can be keyed to a number of controlled and/or specially keyed systems. These range from legally protected keys to protect against unauthorised duplication and can also include specially designed keying systems such as master key systems. This allows for different levels of mechanical access control.

Please refer to assaabloy.com.au for keying systems or contact your local sales office or customer service for specific information.

Standard Finishes

Stainless Steel SS

Extended Cylinders

Modular Cylinder Extensions are available for thicker doors.

Rebate

Rebate kits to suit 13mm standard rebate are available.

Electric Strikes

Lockwood offers a wide range of electric strikes which are compatible with the Selector® 3770 Series Mortice Locks. Refer to lockweb.com.au for further details.

 **HIGH SECURITY**

 **DURABILITY**

 **FIRE RATED**

 **ANTI-CORROSION**

Note:

*For questions concerning our fire rated products, their specifications and their utilization please contact ASSA ABLOY or relevant Fire Door Manufacturer.

All dimensions depicted in this brochure are in mm.

Selector® 3770 MkII Series Cylinder Mortice Locks

1. Multi-function Lock

The new Selector® 3770 MkII Series Mortice Lock was designed to incorporate the full range of lock functions into one primary lock. This reduces stock line items. All functions can be configured by adjusting the hub setting selector, lock function selector as well as using cylinder cams and turn adaptors.

2. Hub Setting Selection

Hub setting can be adjusted via the Selector® 3770 MkII Series hub selector located under the faceplate of the mortice lock. The hub setting allows for three functions: Passage, Combination, or Escape function.

This is done by rotating the dial with a 4mm flat blade screwdriver.

RED - Handle is lockable. Only opened by handle when locking bar is unlocked (up).

GREEN - Opened by handle at all times.

3. Lock Function Setting

The new Selector® 3770 MkII Series Mortice Lock was designed to incorporate a greater range of lock functions into one primary lock. In addition to anti-lockout setting, the Selector® 3770 MkII Series also includes an industry first selectable holdback feature.

N - Neutral Lock
Factory default
Lock operates as a standard lock

A - Anti-lockout Lock
Closing the door or retracting the latch bolt unlocks the lock, preventing lockout situations.

H - Holdback Lock
Latch bolt can be held within the lock.

Holdback must not be activated on fire doors.

4. Backset

Standard backset - 60mm. Extended backsets 89mm and 127mm are available

5. Case Assembly

Zinc diecast body with stainless steel chassis plates for improved strength.

6. Furniture Through Fix Holes

Through fixed escutcheons and turnknobs can now be used with the lock, allowing for more robust fixing of door furniture.

7. Cylinder/Adaptor Retention

"Slip Pin" Cylinder/Adaptor fixing method, which allows attachment to the case by inserting a non-threaded cylindrical pin through the front of the lock case.

8. Cylinder Assembly

Five pin tumbler mechanism. Standard Lockwood oval shaped, brass cylinders and brass barrels. Only two newly designed cams needed for all lock functions.

X7 Cam - Retracts latch bolt with additional ability of locking the locking bar.

V Cam - Locks and unlocks the locking bar. Also retracts latch bolt after unlocking lock.

9. Synergy Retrofit

The Selector® 3770 MkII Series Mortice Lock is designed to have an equivalent case size as the Synergy Series Mortice Lock to ensure retrofitability.

10. Kits

The Selector® 3770 MkII Series primary lock is designed for timber doors. Various kit conversions are available for aluminium door applications, alternative finishes as well as dual entry and DX digital locksets.

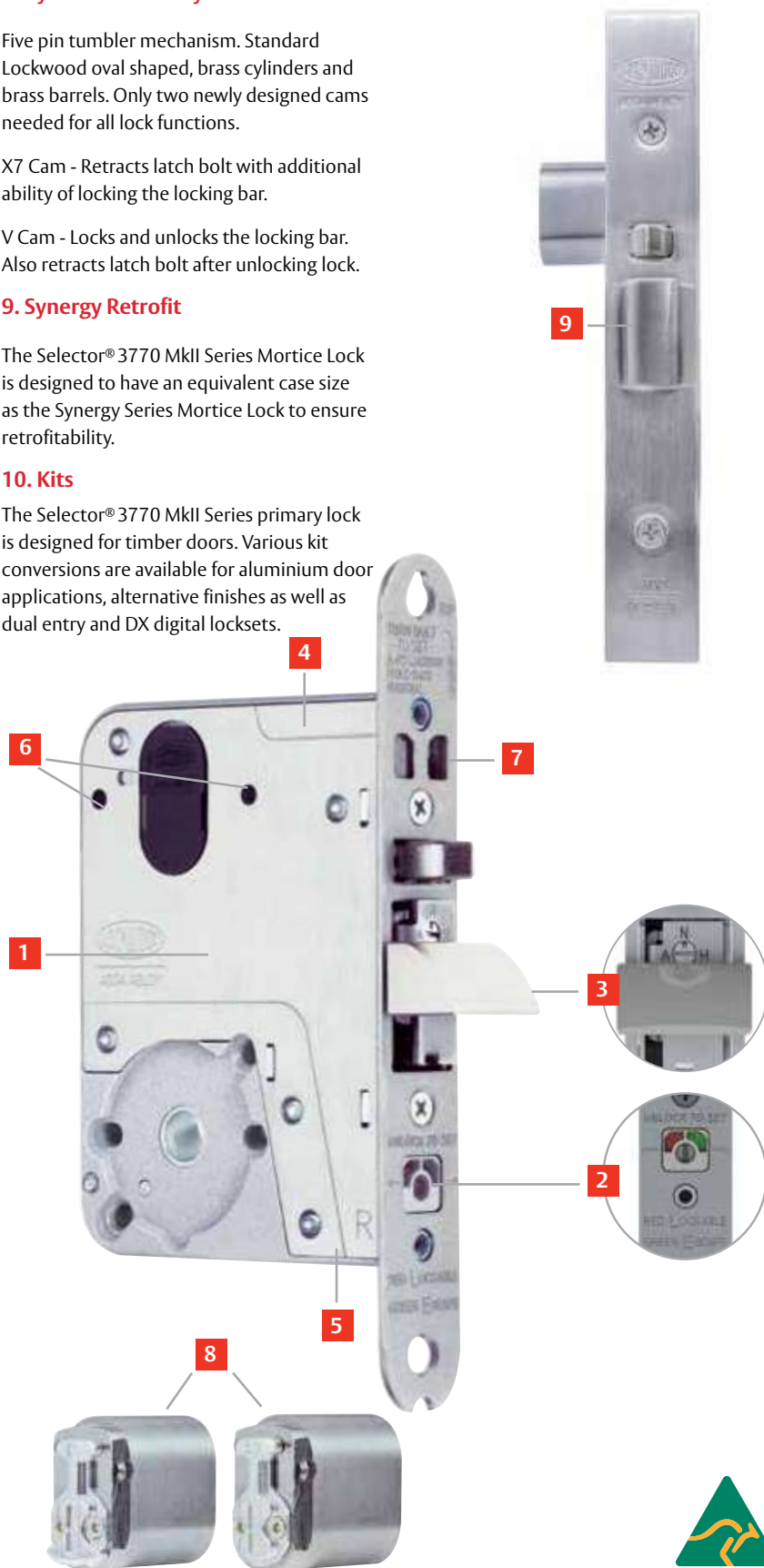

Selector[®] 3770 MkII Mortice Nightlatches



Description

These locks have various latching functions operated by a key outside and by a turnknob or key inside. The mortice nightlatch locks automatically when the door is closed.

Product Details

Backset	Available in 60, 89 and 127mm backsets.
Furniture	Compatible with most Lockwood cylinder escutcheons, turnknobs and plate furniture. Refer to lockweb.com.au for further details.
Latch	Deadlatch only.
Standard	Stainless Steel (SS)
Finishes	Other finishes available via finish kit conversions

Important Note:

The Latching Adaptor for Selector 3770 Series MkII is not backwards compatible. Therefore, 3770M1-ADAPTOR **MUST** be used for Selector Mortice Lock MkI and 3770M2-ADAPTOR **MUST** be used for Selector Mortice Lock MkII.

Selector® 3770 MkII Mortice Nightlatches

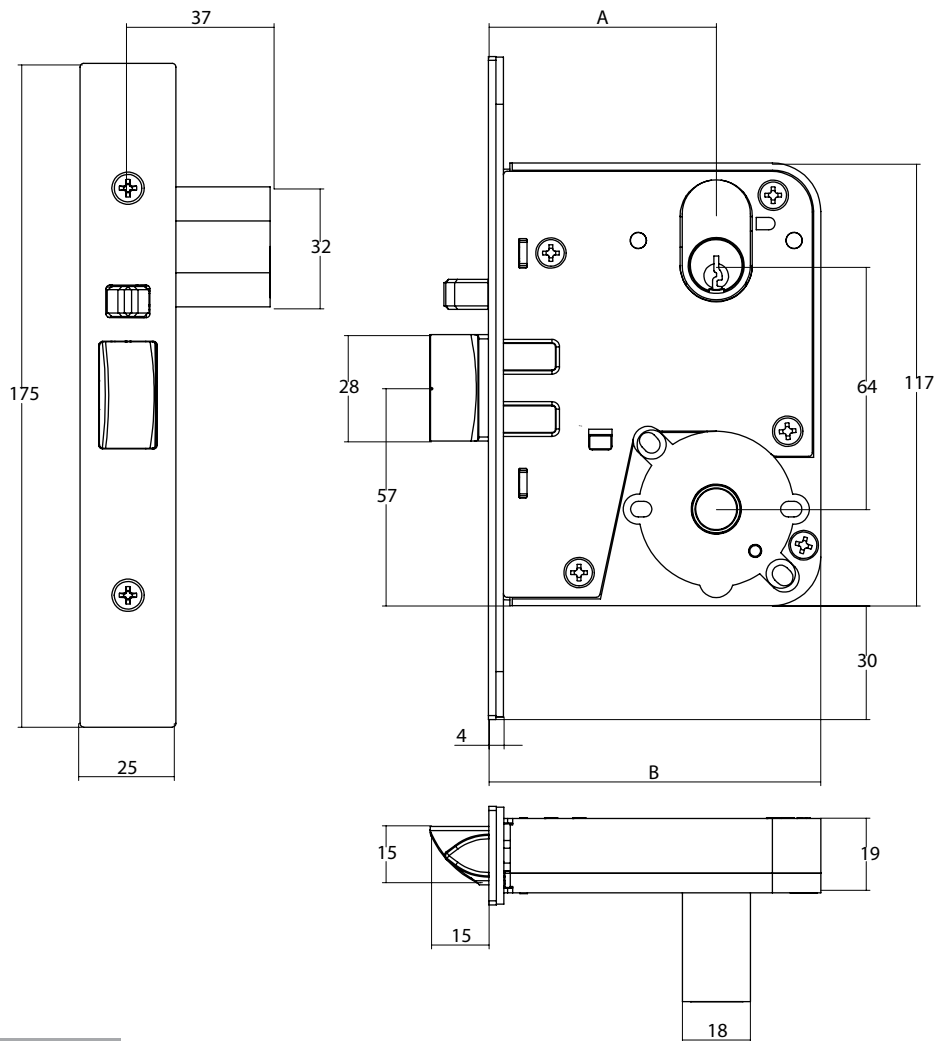

Selector® 3770 Mortice Nightlatches

Part Number	3770	4770	5770
Dimension A	60	89	127
Dimension B	88	117	155

Note: 3772SS Primary Lock can be used to achieve 3770 functions.

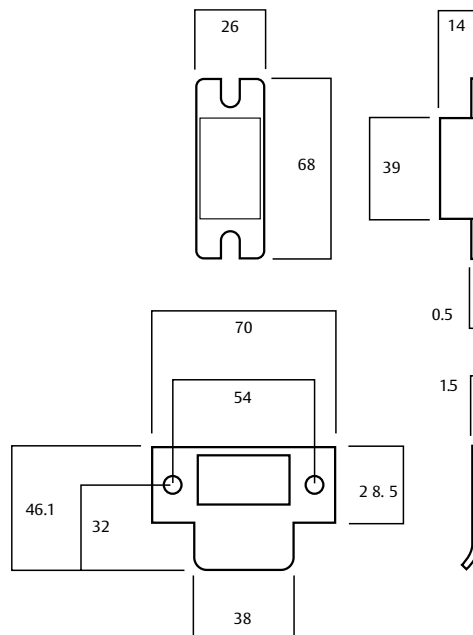

Selector[®] 3770 MkII Mortice Nightlatches

Nightlatch with Turn

Part Number 3770-T

Turnknob inside.

Inside: Opened by turnknob.

This function requires the locking bar to be positioned in the locked position once lock is set.

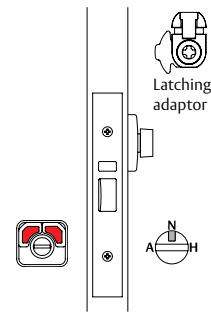

Nightlatch with Cylinder

Part Number 3770X-

Single cylinder.

Outside: Opened by key.

This function requires the locking bar to be positioned in the locked position once lock is set.

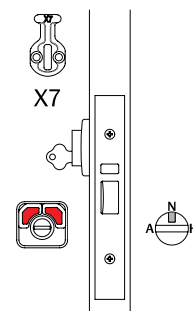

Nightlatch with Cylinder and Turn

Part Number 3770XT

Cylinder and turnknob.

Outside: Opened by key.

Inside: Opened by turnknob.

This function requires the locking bar to be positioned in the locked position once lock is set.

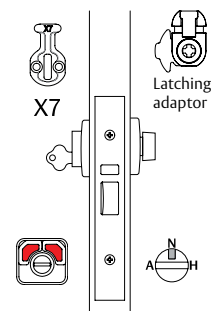

Nightlatch with Double Cylinder

Part Number 3770XX

Double cylinder.

Outside: Opened by key.

Inside: Opened by key.

This function requires the locking bar to be positioned in the locked position once lock is set.

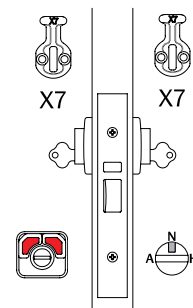

Notes:

All drawings shown are in right hand configuration. Setting instructions only apply if 3772 is used, disregard instructions if using 3770. Part numbers shown above are for 60mm backset lock, if 89mm is required substitute 3 for 4 i.e. 4770, or if 127mm lock is required, substitute 3 for 5 i.e. 5770

Warning:

The Latching Adaptor for Selector 3770 Series MkII is not backwards compatible. Therefore, 3770M1-ADAPTOR **MUST** be used for Selector Mortice Lock MkI and 3770M2-ADAPTOR **MUST** be used for Selector Mortice Lock MkII.

Legend

Hub Setting



Lock Function Setting



Cam or Adaptor



Selector® 3772 MkII Escape Locks



Description

These locks have various latching functions which can be operated by key or handle outside and by turnknob, key or handle inside.

Product Details

Backset	Available in 60, 89 and 127mm backsets.
Furniture	Compatible with most Lockwood rose and plate furniture including Brass Door Furniture, Robert Watson Series, Artefact Series II, Ovation Series and VSR Series. Refer to lockweb.com.au for further details.
Latch	Deadlatch only.
Standard	Stainless Steel (SS)
Finishes	Other finishes available via finish kit conversions

Selector® 3772 MkII Escape Locks

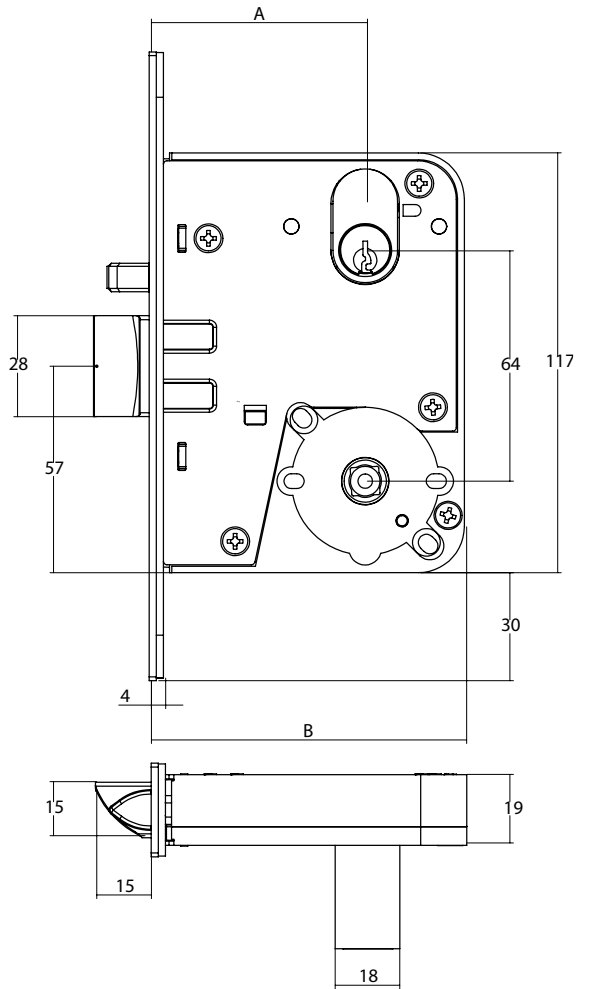
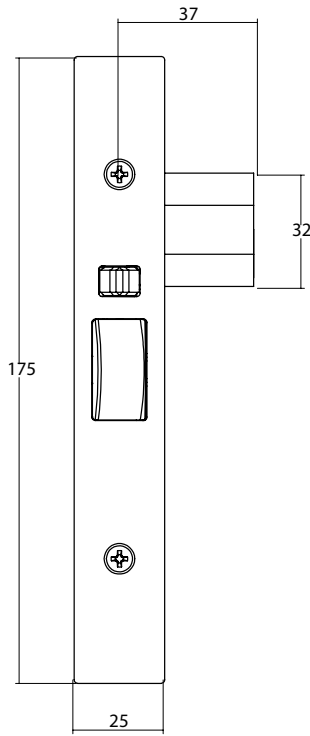

Selector® 3772 Escape Locks

Part Number	3772	4772	5772
Dimension A	60	89	127
Dimension B	88	117	155

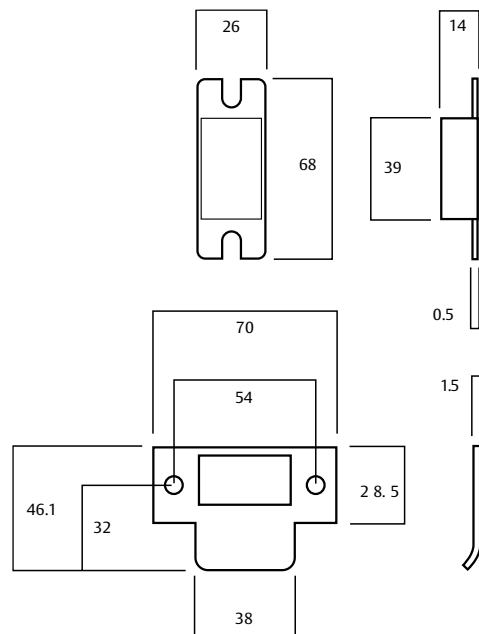

Selector® 3772 MkII Escape Locks

Escape Lock

Part Number 3772--

Outside: Handle always rigid.

Inside: Opened by handle at all times.

This function requires the locking bar to be positioned in the locked position once lock is set.

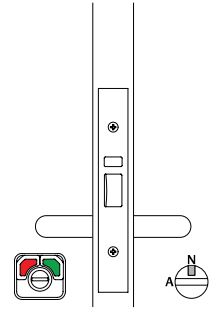

Anti-vandal Escape Lock

Part Number 3772V-

Single cylinder.

Outside: Opened by handle when unlocked. Key locks and unlocks outside handle and retracts bolt after unlocking lock.

Inside: Opened by handles at all times.

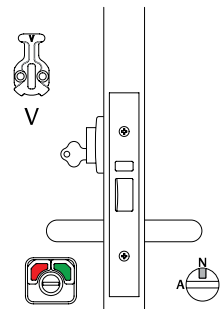

Anti-vandal Escape Lock with Turn

Part Number 3772VT

Cylinder and turnknob.

Outside: Opened by handle when unlocked. Key locks and unlocks outside handle and retracts bolt after unlocking lock.

Inside: Opened by handle at all times. Turnknob locks or unlocks outside handle.

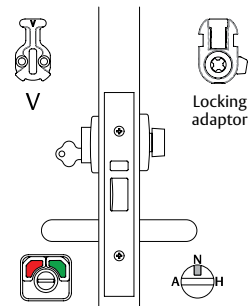

Key Entry Escape Lock

Part Number 3772X-

Single cylinder.

Outside: Opened by key at all times. Handle always rigid.

Inside: Opened by handle at all times.

This function requires the locking bar to be positioned in the locked position once lock is set.

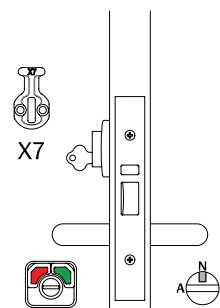

Notes:

All drawings shown are in right hand configuration. Part numbers shown above are for 60mm backset lock, if 89mm is required substitute 3 for 4 i.e. 4772, or if 127mm lock is required, substitute 3 for 5 i.e. 5772

Legend

Hub Setting



Lock Function Setting



Cam or Adaptor



Selector[®] 3772 MkII Escape Locks

Key Entry Escape Lock with Turn

Part Number 3772XT

Cylinder and turnknob.

Outside: Opened by key at all times. Opened by handle when unlocked. Key locks outside handle.

Inside: Opened by handle at all times. Turnknob locks or unlocks outside handle.

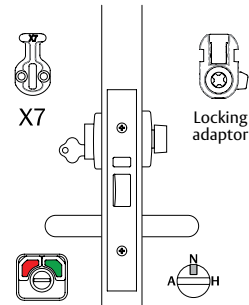

Escape Lock with Internal Cylinder

Part Number 3772-V

Single cylinder.

Outside: Opened by handle when unlocked.

Inside: Opened by handle at all times. Key locks or unlocks outside handle and retracts bolt after unlocking lock.

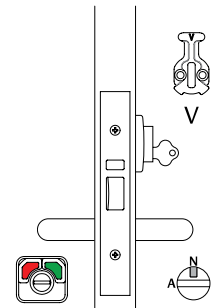

Escape Lock with Turn

Part Number 3772-T

Turnknob inside.

Outside: Opened by handle when unlocked.

Inside: Opened by handle at all times. Turnknob locks or unlocks outside handle.

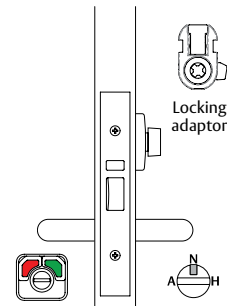

Anti-vandal Escape Lock with Internal Cylinder

Part Number 3772VV

Double Cylinder.

Outside: Opened by handle when unlocked. Key locks or unlocks outside handle and retracts bolt after unlocking lock.

Inside: Opened by handle at all times. Key locks or unlocks outside handle and retracts bolt after unlocking lock.

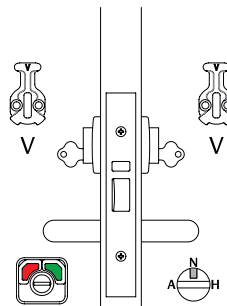

Notes:

All drawings shown are in right hand configuration. Part numbers shown above are for 60mm backset lock, if 89mm is required substitute 3 for 4 i.e. 4772, or if 127mm lock is required, substitute 3 for 5 i.e. 5772

Legend

Hub Setting



Lock Function Setting



Cam or Adaptor



Selector® 3772 MkII Escape Locks

Key Entry Escape Lock with Internal Cylinder

Part Number 3772XV

Double cylinder.

Outside: Opened by key at all times. Opened by handle when unlocked. Key locks outside handle.

Inside: Opened by handle at all times. Key locks or unlocks outside handle and retracts bolt after unlocking lock.

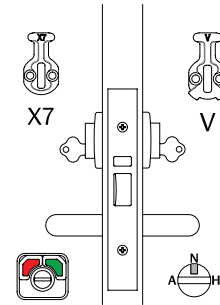

Anti-lockout Escape Lock with Turn*

Part Number 3772-TA

Turnknob inside.

Outside: Opened by handle when unlocked.

Inside: Opened by handle at all times. Turnknob locks or unlocks outside handle.

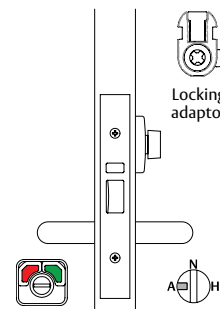

Anti-lockout Anti-vandal Escape Lock with Turn*

Part Number 3772VTA

Cylinder and turnknob.

Outside: Opened by handle when unlocked. Key locks or unlocks outside handle and retracts bolt after unlocking lock.

Inside: Opened by handle at all times. Turnknob locks or unlocks outside handle.

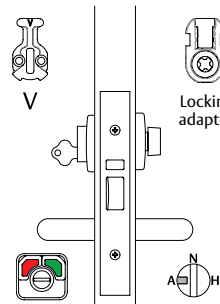

Holdback Anti-vandal Escape Lock#

Part Number 3772V-H

Single cylinder.

Outside: Opened by handle when unlocked. Key locks or unlocks outside handle and retracts bolt after unlocking lock.

Inside: Opened by handle at all times.

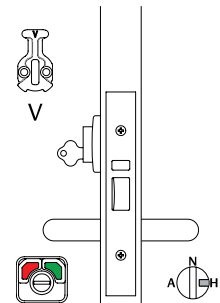

Notes:

All drawings shown are in right hand configuration. Part numbers shown above are for 60mm backset lock, if 89mm is required substitute 3 for 4 i.e. 4772, or if 127mm lock is required, substitute 3 for 5 i.e. 5772

*Anti-lockout - Closing the door or retracting latch bolt unlocks the lock, preventing lockout situations.

Holdback - Latch bolt can be held within the lock. **Holdback must not be activated on fire doors.**

For questions concerning our fire rated products, their specifications and their utilization please contact ASSA ABLOY or relevant Fire Door manufacturer.

Legend

Hub Setting



Lock Function Setting



Cam or Adaptor



Selector® 3772 MkII Escape Locks

Holdback Anti-vandal Escape Lock with Turn#

Part Number 3772VTH

Cylinder and turnknob.

Outside: Opened by handle when unlocked. Key locks or unlocks outside handle and retracts bolt after unlocking lock.

Inside: Opened by handle at all times. Turnknob locks or unlocks outside handle.

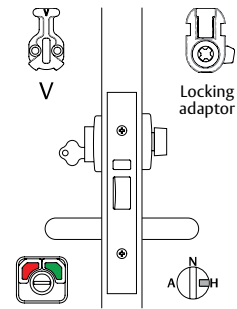

Holdback Key Entry Escape Lock with Internal Cylinder#

Part Number 3772XVH

Double cylinder.

Outside: Opened by key at all times. Opened by handle when unlocked. Key locks outside handle.

Inside: Opened by handle at all times. Key locks or unlocks outside handle and retracts bolt after unlocking lock.

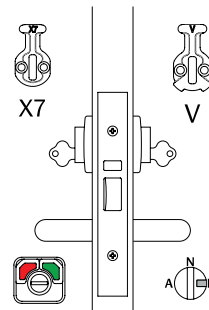

Notes:

All drawings shown are in right hand configuration.

Part numbers shown above are for 60mm backset lock, if 89mm is required substitute 3 for 4 i.e. 4772, or if 127mm lock is required, substitute 3 for 5 i.e. 5772

*Anti-lockout - Closing the door or retracting latch bolt unlocks the lock, preventing lockout situations.

#Holdback - Latch bolt can be held within the lock. **Holdback must not be activated on fire doors.**

For questions concerning our fire rated products, their specifications and their utilization please contact ASSA ABLOY or relevant Fire Door manufacturer.

Legend

Hub Setting



Lock Function Setting



Cam or Adaptor



Selector® 3774 MkII Passage Latch



Description

The Passage latch only has a plainlatch. It allows operation of outside and inside handles at all times with no locking functions. Ideal for interconnecting doors.

Product Details

Backset	Available in 60, 89 and 127mm backsets.
Furniture	Compatible with most Lockwood rose and plate furniture including Brass Door Furniture, Robert Watson Series, Artefact Series II, Ovation Series and VSR Series. Refer to lockweb.com.au for further details.
Latch	Plainlatch only
Standard Finishes	Stainless Steel (SS) Other finishes available via finish kit conversions.

Selector® 3774 MkII Passage Latch

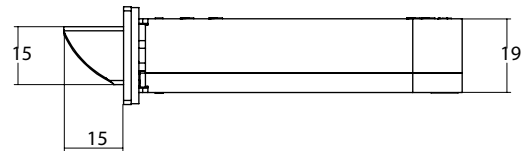
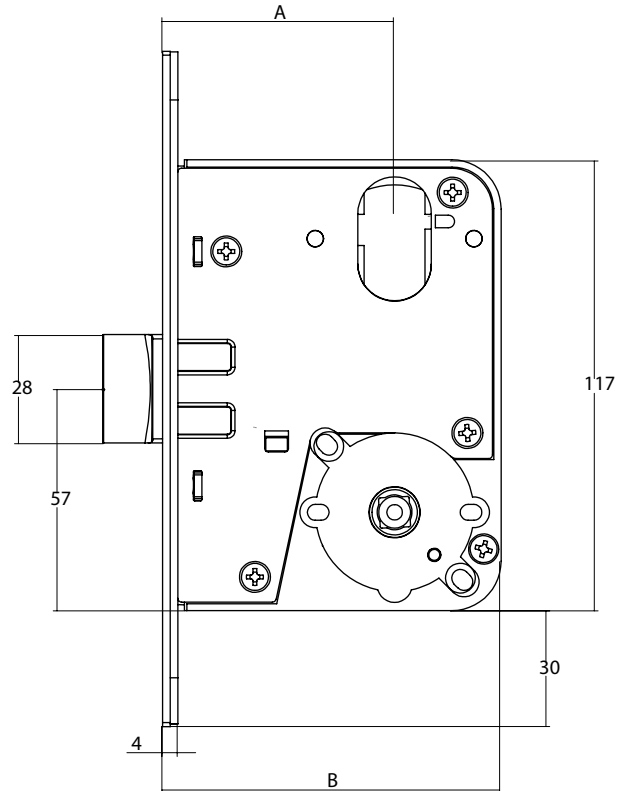
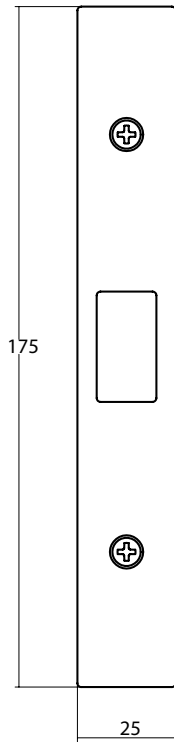

Selector® 3774 Passage Latch

Part Number	3774	4774	5774
Dimension A	60	89	127
Dimension B	88	117	155

Note: Passage Latch primary lock only available in 60mm backset (3774). For extended backset options, please order 4772/5772 primary lock and configure accordingly.

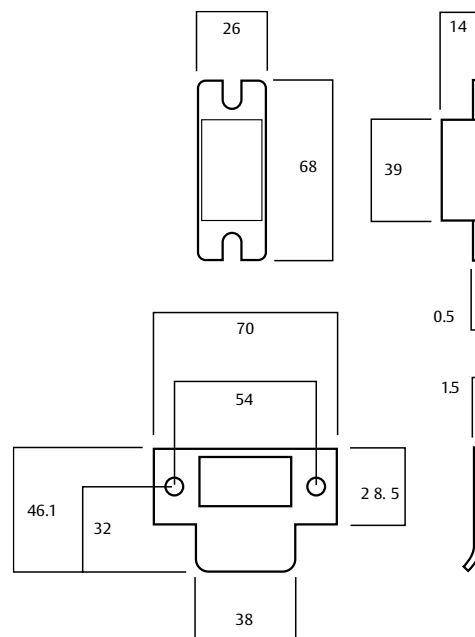

Selector® 3774 MkII Passage Latch

Passage Latch

Part Number 3774

No locking function. Plainlatch only.

Outside: Opened by handle at all times.

Inside: Opened by handle at all times.

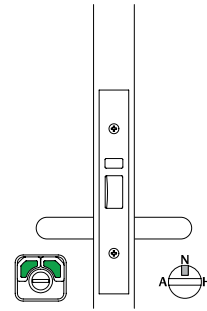

Notes:

Setting instructions only apply if 3772 is used, disregard instructions if using 3774.

All drawings shown are in right hand configuration.

Part numbers shown above are for 60mm backset lock, if 89mm is required substitute 3 for 4 i.e. 4772, or if 127mm lock is required, substitute 3 for 5 i.e. 5772

Legend

Hub Setting



Lock Function Setting



Cam or Adaptor



Selector® 3774 MkII Combination Locks



Description

These locks have various latching functions operated generally by outside or inside handles, except when locked by key outside or by key or turnknob inside.

Product Details

Backset	Available in 60, 89 and 127mm backsets.
Furniture	Compatible with most Lockwood rose and plate furniture including Brass Door Furniture, Robert Watson Series, Artefact Series II, Ovation Series and VSR Series. Refer to lockweb.com.au for further details.
Latch	Deadlatch only.
Standard Finishes	Stainless Steel (SS) Other finishes available via finish kit conversions.

Selector® 3774 MkII Combination Locks

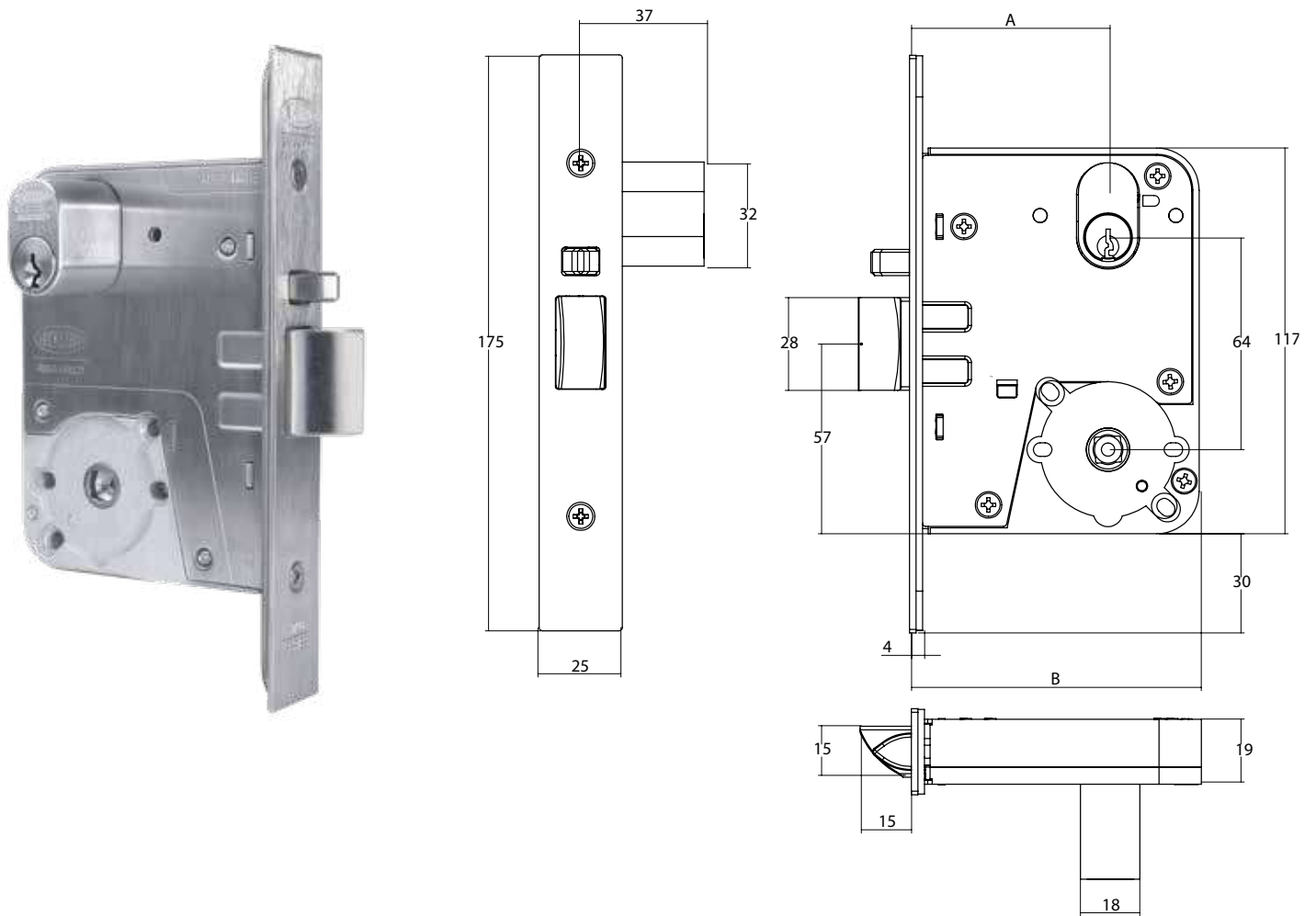

Selector® 3774 Combintion Locks

Part Number	3774	4774	5774
Dimension A	60	89	127
Dimension B	88	117	155

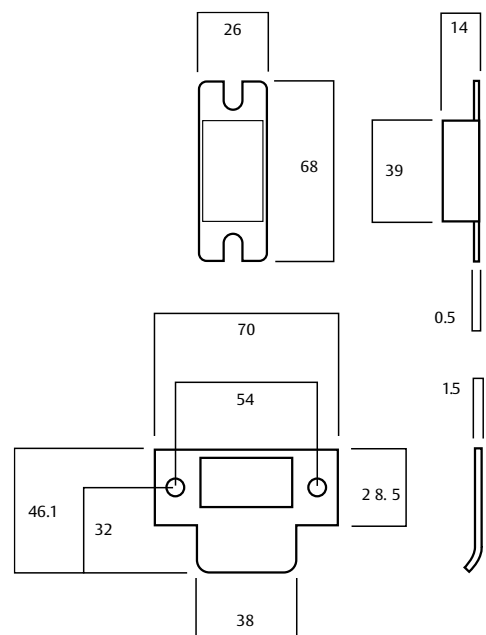

Selector® 3774 MkII Combination Locks

Anti-vandal Lock with Turn

Part Number 3774VT

Cylinder and turnknob.

Outside: Opened by handle when unlocked. Key locks or unlocks both handles and retracts bolt after unlocking lock.

Inside: Opened by handle when unlocked. Turnknob locks or unlocks both handles.

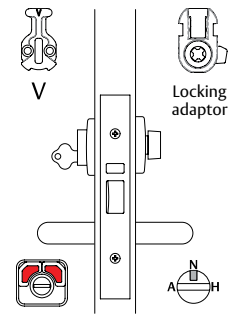

Anti-vandal Lock with Internal Cylinder

Part Number 3774W

Double cylinder.

Outside: Opened by handle when unlocked. Key locks or unlocks both handles and retracts bolt after unlocking lock.

Inside: Opened by handle when unlocked. Key locks or unlocks both handles and retracts bolt after unlocking lock.

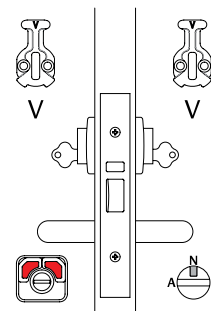

Key Entry Lock with Internal Cylinder

Part Number 3774XV

Double Cylinder.

Outside: Opened by key at all times. Opened by handle when unlocked. Key locks both handles.

Inside: Opened by handle when unlocked. Key locks or unlocks both handles and retracts bolt after unlocking lock.

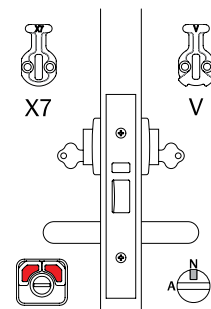

Notes:

All drawings shown are in right hand configuration. Part numbers shown above are for 60mm backset lock, if 89mm is required substitute 3 for 4 i.e. 4774, or if 127mm lock is required, substitute 3 for 5 i.e. 5774

Legend	
Hub Setting	
Lock Function Setting	
Cam or Adaptor	

Selector[®] 3774 MkII Combination Locks

Key Entry Double Cylinder Lock

Part Number 3774XX

Double cylinder.

Outside: Opened by key at all times. Handle always rigid.

Inside: Opened by key at all times. Handle always rigid.

This function requires the locking bar to be positioned in the locked position once lock is set.

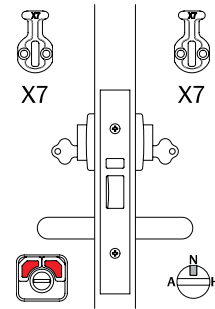

Combination Lock with Turn

Part Number 3774-T

Turnknob inside.

Outside: Opened by handle when unlocked.

Inside: Opened by handle when unlocked. Turnknob locks or unlocks both handles.

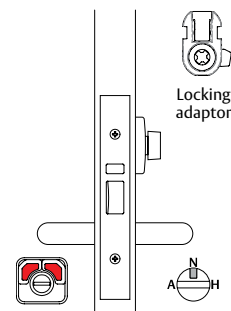

Anti-lockout Combination Lock with Turn*

Part Number 3774-TA

Turnknob inside.

Outside: Opened by handle when unlocked.

Inside: Opened by handle when unlocked. Turnknob locks or unlocks both handles.

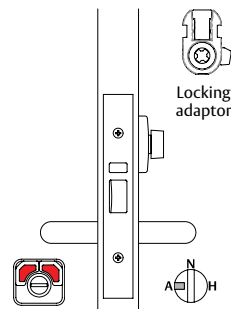

Anti-lockout Anti-vandal Lock with Turn*

Part Number 3774VTA

Cylinder and turnknob.

Outside: Opened by handle when unlocked. Key locks or unlocks both handles and retracts bolt after unlocking lock.

Inside: Opened by handle when unlocked. Turnknob locks or unlocks both handles.

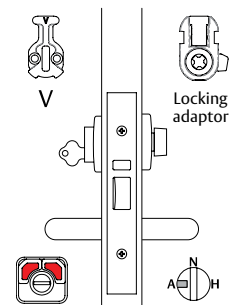

Notes:

All drawings shown are in right hand configuration. Part numbers shown above are for 60mm backset lock, if 89mm is required substitute 3 for 4 i.e. 4774, or if 127mm lock is required, substitute 3 for 5 i.e. 5774

*Anti-lockout - Closing the door or retracting latch bolt unlocks the lock, preventing lockout situations.

Legend

Hub Setting



Lock Function Setting



Cam or Adaptor



Selector® 3774 MkII Combination Locks

Anti-lockout Anti-vandal Lock with Internal Cylinder*

Part Number 3774VVA

Double cylinder.

Outside: Opened by handle when unlocked. Key locks or unlocks both handles and retracts bolt after unlocking lock.

Inside: Opened by handle when unlocked. Key locks or unlocks both handles and retracts bolt after unlocking lock.

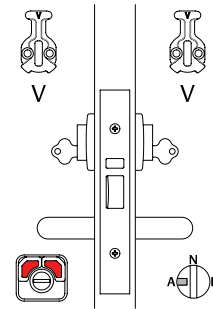

Holdback Anti-vandal Lock with Turn#

Part Number 3774VTH

Cylinder and turnknob.

Outside: Opened by handle when unlocked. Key locks or unlocks both handles and retracts bolt after unlocking lock.

Inside: Opened by handle when unlocked. Turnknob locks or unlocks both handles.

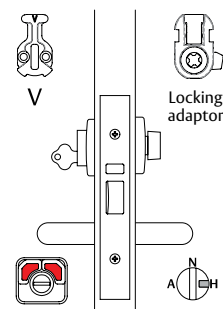

Holdback Anti-vandal Lock with Internal Cylinder#

Part Number 3774VVH

Double cylinder.

Outside: Opened by handle when unlocked. Key locks or unlocks both handles and retracts bolt after unlocking lock.

Inside: Opened by handle when unlocked. Key locks or unlocks both handles and retracts bolt after unlocking lock.

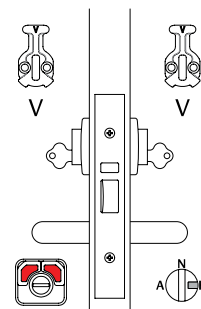

Holdback Key Entry Lock with Internal Cylinder#

Part Number 3774XVH

Double cylinder.

Outside: Opened by key at all times. Opened by handle when unlocked. Key locks both handles.

Inside: Opened by handle when unlocked. Key locks or unlocks both handles and retracts bolt after unlocking lock.

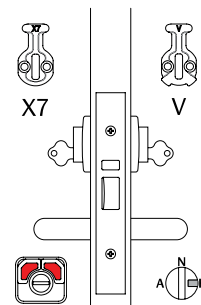

Notes:

All drawings shown are in right hand configuration. Part numbers shown above are for 60mm backset lock, if 89mm is required substitute 3 for 4 i.e. 4774, or if 127mm lock is required, substitute 3 for 5 i.e. 5774

*Anti-lockout - Closing the door or retracting latch bolt unlocks the lock, preventing lockout situations.

#Holdback - Latch bolt can be held within the lock. **Holdback must not be activated on fire doors.**

For questions concerning our fire rated products, their specifications and their utilization please contact ASSA ABLOY or relevant Fire Door manufacturer.

Legend

Hub Setting



Lock Function Setting



Cam or Adaptor



Selector® 3777 MkII Dual Entry Locks



Description

Designed to enable third parties such as emergency services to enter specific areas by second cylinder; without giving access to all locksets in the building and the ability to lockout keys with restricted access at certain times.

Product Details

Furniture

Select from Lockwood 1800, 2800 or Artefact Series II ranges. Refer to lockweb.com.au for further details.

Standard Finishes

Stainless Steel (SS)
Other finishes available via finish kit conversions

Note:

The Selector 3770 MkII Series has a new Lower Cylinder Mounting Kit (3777-KIT) which can hold the 570E, 577 and 10,000 cylinders. For Selector 3770 MkII Series mortice locks, the 3777M1-KIT570E or 3777M1-KIT577 Lower Cylinder Mounting Kit must be ordered.

Selector® 3777 MkII Dual Entry Locks

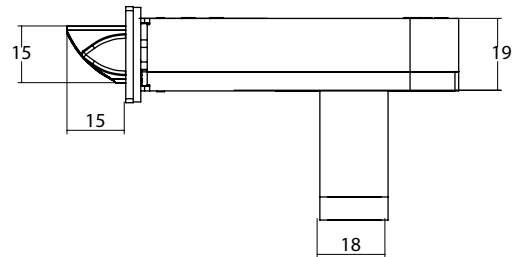
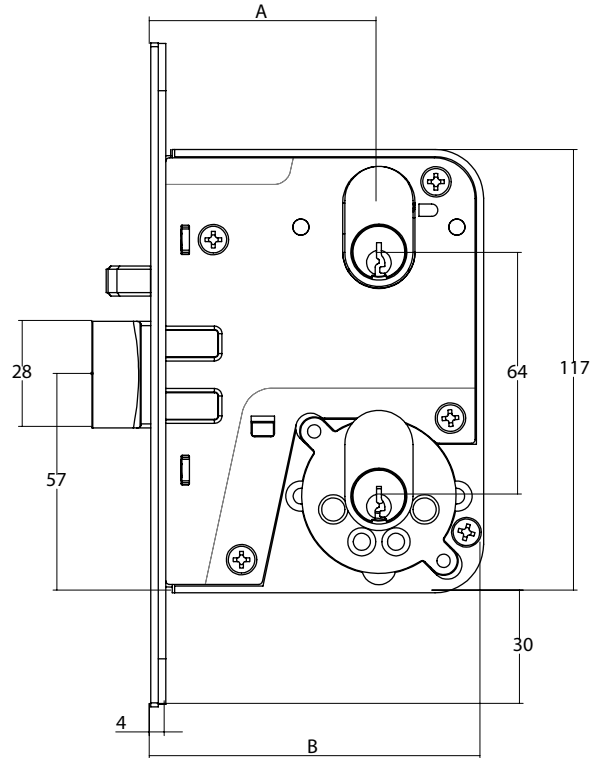
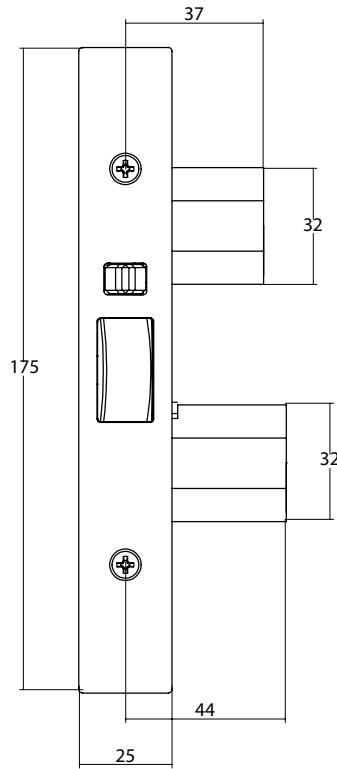

Selector® 3777 Dual Entry Locks

Part Number	3777	4777	5777
Dimension A	60	89	127
Dimension B	88	117	155

Note: Order by specifying 3772SS primary lock and 3777-KIT Dual Entry Kit. Cylinders must be ordered separately.

The Selector 3770 MkII Series has a new Lower Cylinder Mounting Kit (3777-KIT) which can hold the 570E, 577 and 10,000 cylinders. For Selector 3770 MkI Series mortice locks, the 3777M1-KIT570E or 3777M1-KIT577 Lower Cylinder Mounting Kit must be ordered.

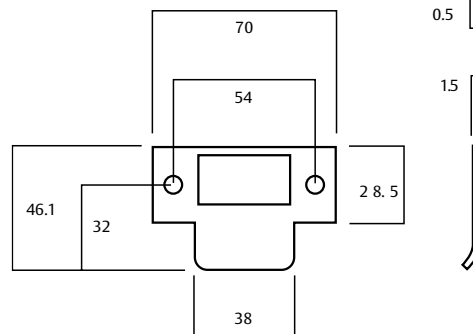
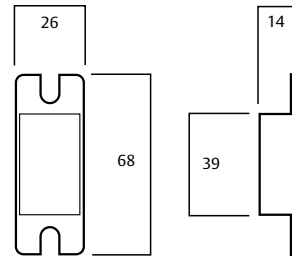

Selector® 3777 MkII Dual Entry Locks

Dual Entry Lock

Part Number 3777X-

Two cylinders outside.

Outside: Opened by key. Cylinders are keyed to differ.

Inside: Opened by handle at all times.

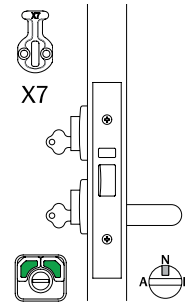

Dual Entry Lock with Lower Cylinder Lockout

Part Number 3777V-

Two cylinders outside.

Outside: Opened by key when unlocked. Upper cylinder key locks or unlocks lower cylinder and retracts bolt after unlocking lock. Cylinders are keyed to differ.

Inside: Opened by handle at all times.

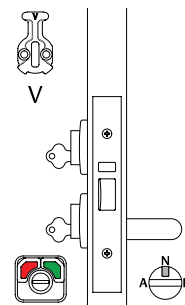

Notes:

All drawings shown are in right hand configuration. Part numbers shown above are for 60mm backset lock, if 89mm is required substitute 3 for 4 i.e. 4777, or if 127mm lock is required, substitute 3 for 5 i.e. 5777

*Anti-lockout - Closing the door or retracting latch bolt unlocks the lock, preventing lockout situations.

Legend

Hub Setting



Lock Function Setting



Cam or Adaptor



Selector[®] MkII Privacy Locks



Description

Privacy locks allow doors to be unlocked from the outside via an emergency button. These locks have various latching functions which can be operated by key or handle outside and by handle inside.

Product Details

Backset	Available in 60, 89 and 127mm backsets.
Furniture	Compatible with most Lockwood rose and plate furniture including Brass Door Furniture, Robert Watson Series, Artefact Series II, Ovation Series and VSR Series. Refer to lockweb.com.au for further details.
Latch	Deadlatch only.
Standard Finishes	Stainless Steel (SS) Other finishes available via finish kit conversions

Selector® MkII Privacy Locks

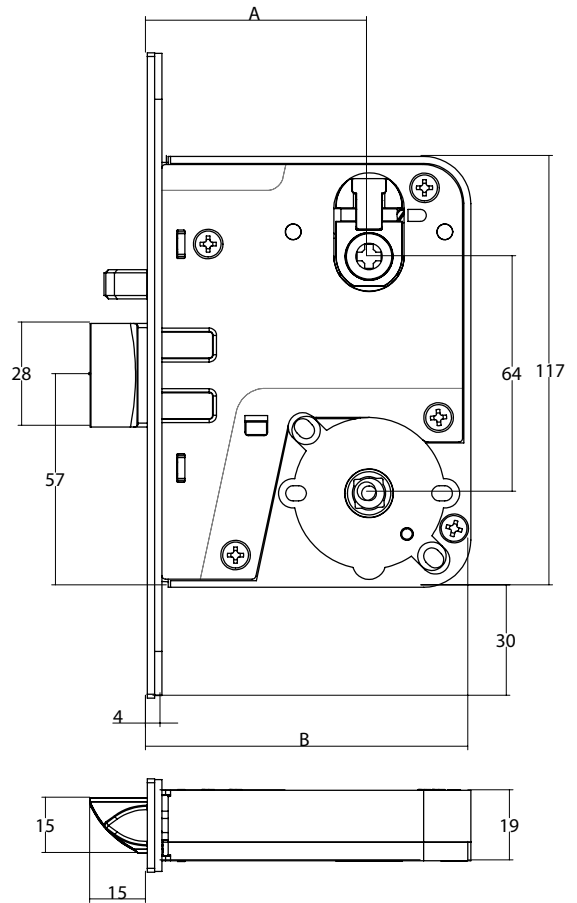
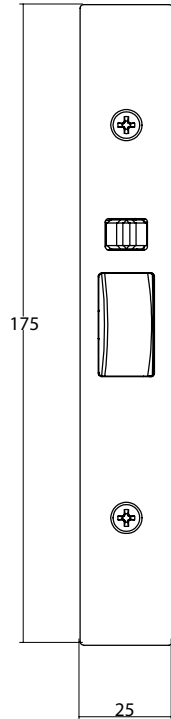

Selector® Privacy Locks

Part Number	3772	4772	5772
Dimension A	60	89	127
Dimension B	88	117	155

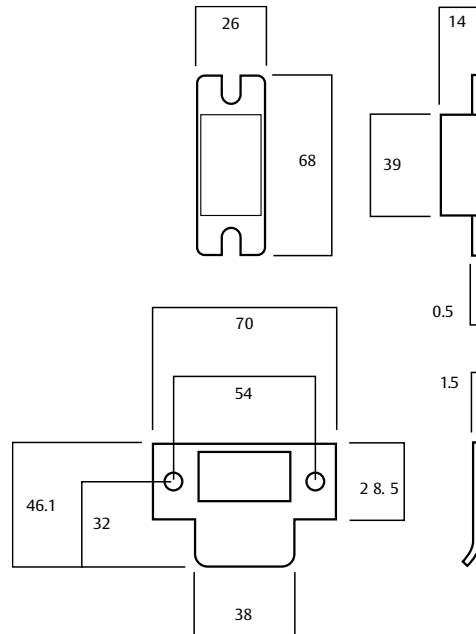

Selector® MkII Privacy Locks

Escape Privacy Lock

Part Number 3772-T

Emergency button and turnknob.

Outside: Opened by handle when unlocked. Emergency button locks or unlocks outside handle - operated by screwdriver or coin.

Inside: Opened by handle at all times. Turnknob locks or unlocks outside handle.

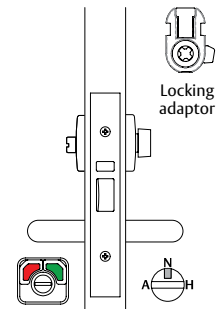

Anti-lockout Escape Privacy Lock*

Part Number 3772-TA

Emergency button and turnknob.

Outside: Opened by handle when unlocked. Emergency button locks or unlocks outside handle - operated by screwdriver or coin.

Inside: Opened by handle at all times. Turnknob locks or unlocks outside handle.

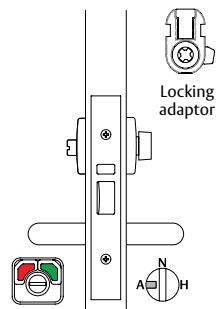

Privacy Lock

Part Number 3774-T

Emergency button and turnknob.

Outside: Opened by handle when unlocked. Emergency button locks or unlocks both handles - operated by screwdriver or coin.

Inside: Opened by handle when unlocked. Turnknob locks or unlocks both handles.

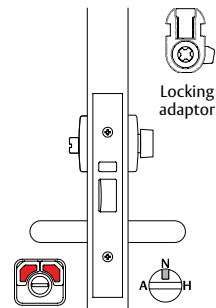

Anti-lockout Privacy Lock*

Part Number 3774-TA

Emergency button and turnknob.

Outside: Opened by handle when unlocked. Emergency button locks or unlocks both handles - operated by screwdriver or coin.

Inside: Opened by handle when unlocked. Turnknob locks or unlocks both handles.

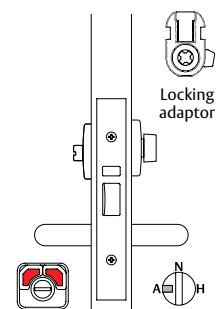

Notes:

All drawings shown are in right hand configuration. Part numbers shown above are for 60mm backset lock, if 89mm is required substitute 3 for 4 i.e. 4772, or if 127mm lock is required, substitute 3 for 5 i.e. 5772

*Anti-lockout - Closing the door or retracting latch bolt unlocks the lock, preventing lockout situations.

Legend

Hub Setting



Lock Function Setting



Cam or Adaptor



Selector® MkII Privacy Locks

Key Entry Privacy Lock

Part Number 3777-T

Lower cylinder outside, emergency button and turnknob.

Outside: Opened by key when unlocked. Emergency button locks or unlocks outside key and inside handle - operated by screwdriver or coin.

Inside: Opened by handle when unlocked. Turnknob locks or unlocks outside key and inside handle.

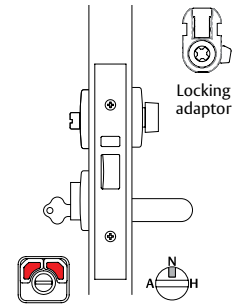

Key Entry Anti-lockout Privacy Lock*

Part Number 3777-TA

Lower cylinder outside, emergency button and turnknob.

Outside: Opened by key when unlocked. Emergency button locks or unlocks outside key and inside handle - operated by screwdriver or coin.

Inside: Opened by handle when unlocked. Turnknob locks or unlocks outside key and inside handle.

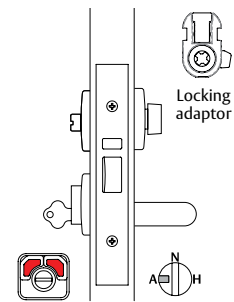

Notes:

All drawings shown are in right hand configuration. Part numbers shown above are for 60mm backset lock, if 89mm is required substitute 3 for 4 i.e. 4772, or if 127mm lock is required, substitute 3 for 5 i.e. 5772

*Anti-lockout - Closing the door or retracting latch bolt unlocks the lock, preventing lockout situations.

Legend	
Hub Setting	
Lock Function Setting	
Cam or Adaptor	

Selector® 3772 MkII DX Digital Mortice



Description

Lockwood DX Digital Locksets provide a mechanical method of keyless entry and are designed to control access into commercial areas.

For extra security when under forced attack, the inbuilt clutching mechanism allows the outside turnknob to rotate without operating or damaging the lock.

The factory set 4 digit code is easily changed to any 4, 5 or 6 digit code using the code changing kit provided with each lock.

As the digital lockset utilizes mechanical operation, electrical wiring is not required.

Outside Function

Press the C button, enter the correct code, then turn the turnknob to unlock the door. Upon releasing the turnknob the code is automatically cancelled.

Warning:

The Latching Adaptor for Selector 3770 Series MkII is not backwards compatible. Therefore, 3770M1-ADAPTOR **MUST** be used for Selector Mortice Lock MkI and 3770M2-ADAPTOR **MUST** be used for Selector Mortice Lock MkII.

Product Details

Backset Available in 60, 89 and 127mm backsets.

Door Thickness 32mm to 50mm

Finish Codepad: Satin Chrome Brushed (SC)
Mortice Lock: Stainless Steel (SS)

Codepad Assembly High purity zinc alloy, 45mm wide, 164mm high, 52mm projection

Latch Stainless steel with 15mm projection

Door Furniture (Lockwood 1800 and 2800 Series) must be ordered separately.

Inside Function

Opened by lever handle at all times.

Holdback Function

A key operated holdback function is available as a lock setting and requires the inclusion of an internal cylinder.

Selector® 3772 MkII DX Digital Mortice



Exterior



Interior

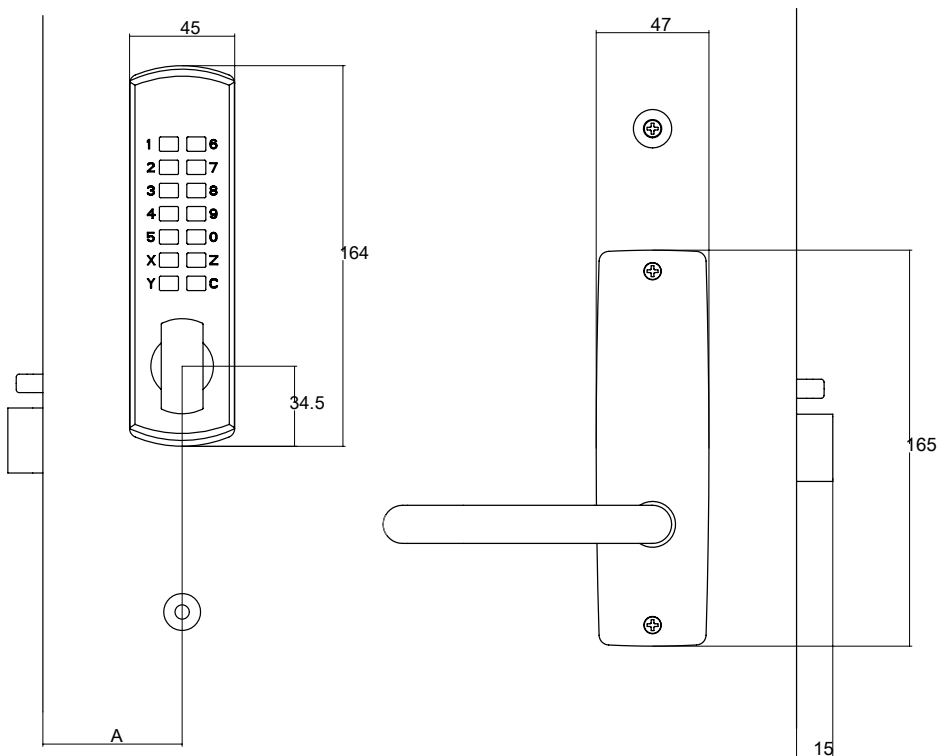

Selector® 3772 DX Digital Mortice Locks

Part Number	3772DX	4772DX	5772DX
Dimension A	60	89	127

Note: Order by specifying 3772SS primary lock and 3772-DXKITSC.

For the 3772SS MkI primary lock, 3772M1-DXKITSC conversion kit must be ordered.

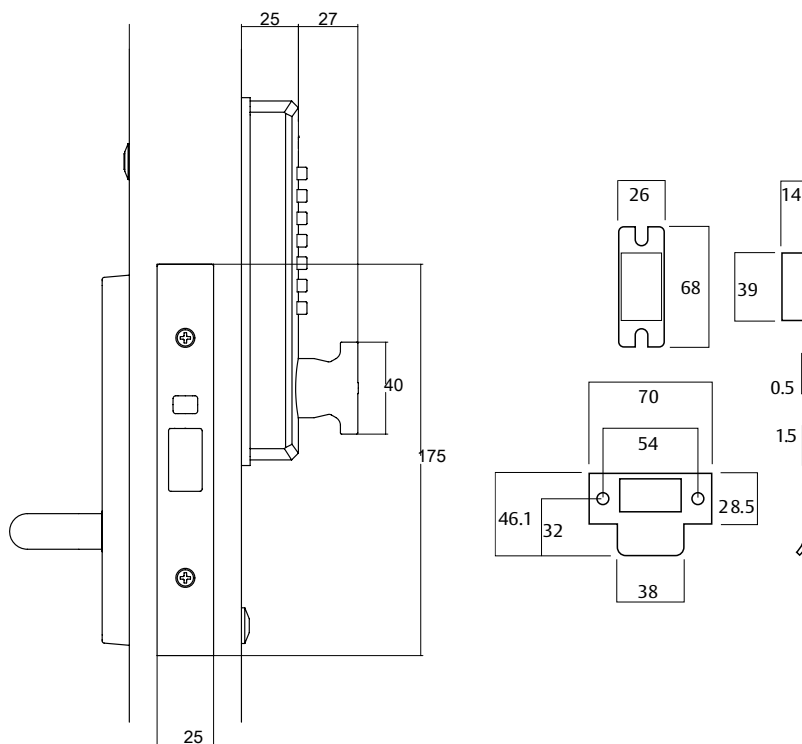

Selector® 3772 MkII DX Digital Mortice

DX Digital Mortice Lock

Part Number 3772DX-

DX Digital outside, plate furniture inside.

Outside: Opened by DX Digital with code.

Inside: Opened by handle at all times.

This function requires the locking bar to be positioned in the locked position once lock is set.

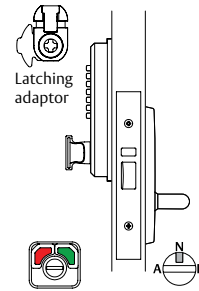

DX Digital Mortice Lock with Holdback by Cylinder#

Part Number 3772DXVH

DX Digital outside, plate furniture and cylinder inside.

Outside: Opened by DX Digital with code.

Inside: Opened by handle at all times. Holdback activated by key. Key retracts latch after releasing holdback.

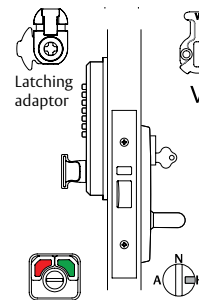

Notes:

All drawings shown are in right hand configuration. Part numbers shown above are for 60mm backset lock, if 89mm is required substitute 3 for 4 i.e. 4772, or if 127mm lock is required, substitute 3 for 5 i.e. 5772

#Holdback - Latch bolt can be held within the lock. **Holdback must not be activated on fire doors.**

For questions concerning our fire rated products, their specifications and their utilization please contact ASSA ABLOY or relevant Fire Door manufacturer.

Warning:

The MkI Latching Adaptor (now part number 3770M1-ADAPTOR) can only be used with the MkI Selector Mortice Locks and the MkII Latching Adaptor (3770M2-ADAPTOR) can only be used with MkII Selector Mortice Locks.

Legend

Hub Setting



Lock Function Setting



Cam or Adaptor



Selector® 3772 MkII Key Override DX Digital Mortice Locks



Description

Lockwood DX Digital Locksets provide a mechanical method of keyless entry and are designed to control access into commercial areas.

For extra security when under forced attack, the inbuilt clutching mechanism allows the outside turnknob to rotate without operating or damaging the lock.

The factory set 4 digit code is easily changed to any 4, 5 or 6 digit code using the code changing kit provided with each lock.

As the digital lockset utilizes mechanical operation, electrical wiring is not required.

Outside Function

Outside: Press the C button, enter the correct code, then turn the turnknob to unlock the door. Upon releasing the turnknob the code is automatically cancelled. The key override pin tumbler cylinder enables quick access by key for authorities such as the fire brigade or those who need to carry a master key to access all rooms of a building.

Warning:

The Latching Adaptor for Selector 3770 Series MkII is not backwards compatible. Therefore, 3770M1-ADAPTOR **MUST** be used for Selector Mortice Lock MkI and 3770M2-ADAPTOR **MUST** be used for Selector Mortice Lock MkII.

Product Details

Backset	Available in 60, 89 and 127mm backsets.
Cylinder	Pin tumbler mechanism with oval brass cylinder
Door Thickness	32mm to 50mm
Finish	Codepad: Satin Chrome Brushed (SC) Mortice Lock: Stainless Steel (SS)
Latch	Stainless steel with 15mm projection

Door Furniture (Lockwood 1800 and 2800 Series) and lower cylinder must be ordered separately.

Inside Function

Opened by lever handle at all times.

Holdback Function

A key operated holdback function is available as a lock setting and requires the inclusion of an internal cylinder.

Selector® 3772 MkII Key Override DX Digital Mortise Locks



Exterior



Interior

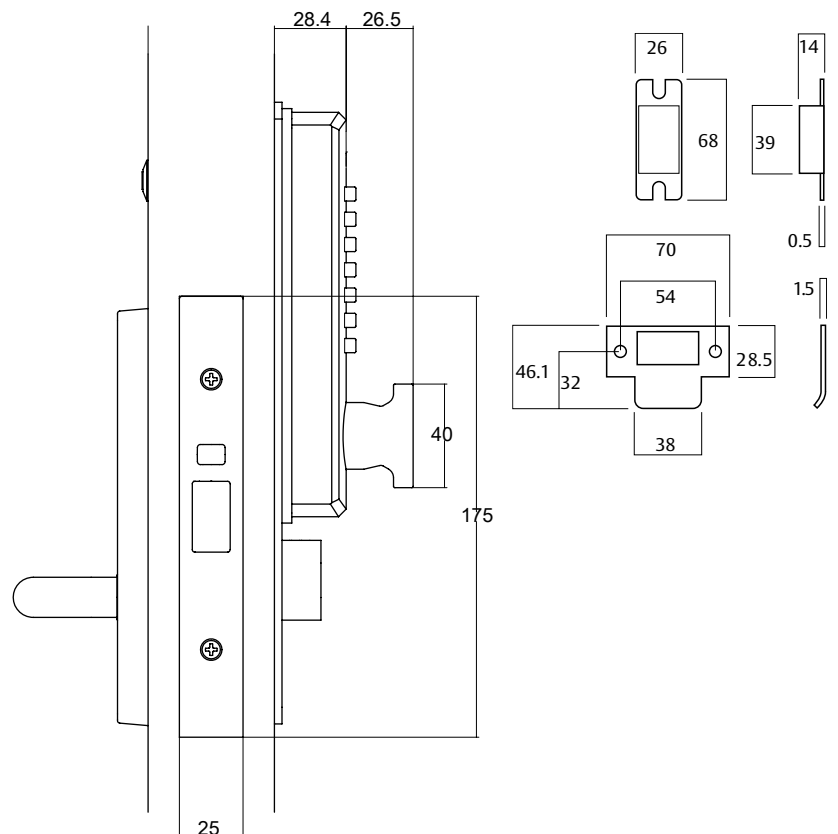
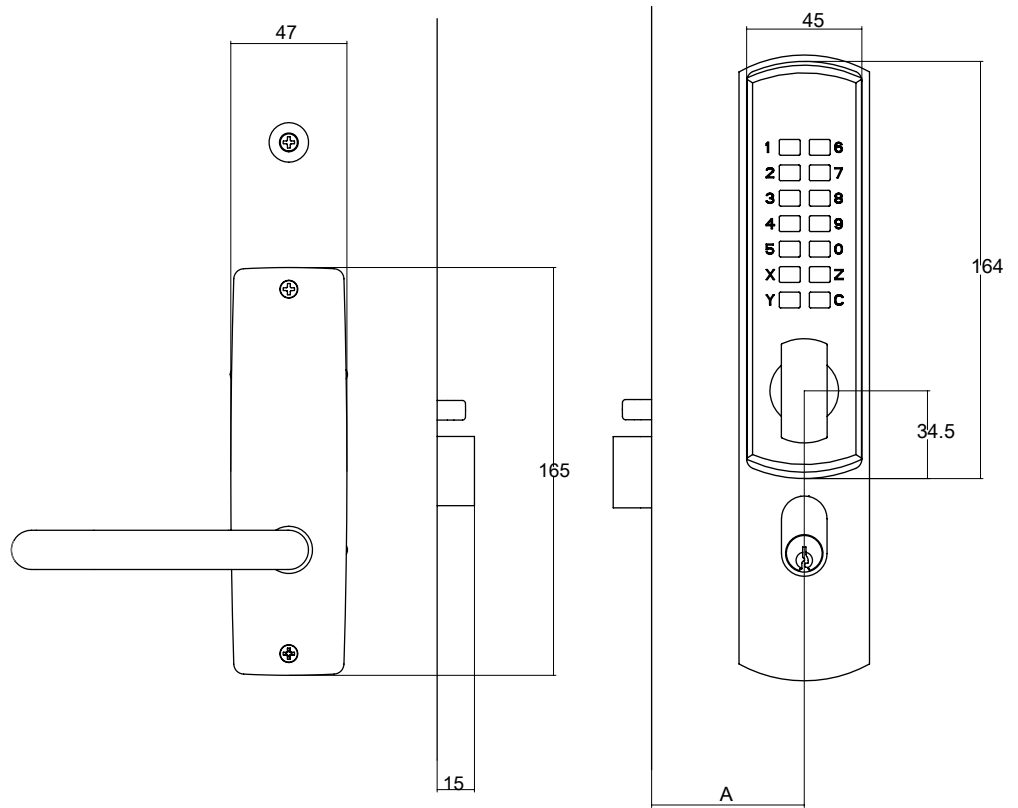

Selector® 3772 Key Override DX Digital Mortise Locks

Part Number	3772DXKO	4772DXKO	5772DXKO
Dimension A	60	89	127

Note: Order by specifying 3772SS primary lock and 3772-DXKOKITSC. Cylinders must be ordered separately.

For 3772SS MkI primary lock, 3772M1-DXKOKITSC must be ordered.

Selector® 3772 MkII Key Override DX Digital Mortice Locks

Key Override DX Digital Mortice Lock

Part Number 3772DXKO-

DX Digital and lower cylinder outside, plate furniture inside.
Outside: Opened by DX Digital with code or key at all times.

Inside: Opened by handle at all times.

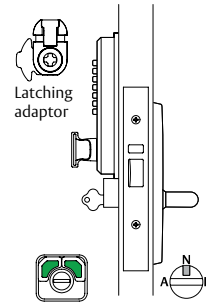

Key Override DX Digital Mortice Lock with Holdback by Cylinder#

Part Number 3772DXKOVH

DX Digital and lower cylinder outside, plate furniture
and cylinder inside.

Outside: Opened by DX Digital with code or key at all times.

Inside: Opened by handle at all times. Holdback activated by key.
Key retracts latch after releasing holdback.

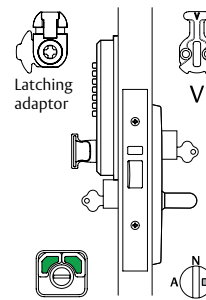

Notes:

All drawings shown are in right hand configuration.

Part numbers shown above are for 60mm backset lock, if 89mm is required substitute 3 for 4 i.e. 4772, or if 127mm lock is required, substitute 3 for 5 i.e. 5772

#Holdback - Latch bolt can be held within the lock. **Holdback must not be activated on fire doors.** For questions concerning our fire rated products, their specifications and their utilization please contact ASSA ABLOY or relevant Fire Door manufacturer.

Warning:

The MkI Latching Adaptor (now part number 3770M1-ADAPTOR) can only be used with the MkI Selector Mortice Locks and the MkII Latching Adaptor (3770M2-ADAPTOR) can only be used with MkII Selector Mortice Locks.

Legend

Hub Setting



Lock Function Setting



Cam or Adaptor



Selector® 3770 Series Accessories

Dual Entry Kits

Part Number	Application
3777-KIT	For new 3777 dual entry applications

Dual Entry kit includes: Lower cylinder mounting plate, spindle cam and mounting screws.

Cylinders must be ordered separately.

The new MkII 3770 Series Lower Cylinder Mounting Kit (3777-KIT) can hold the 570E, 577 and 10,000 cylinders. Selector MkI 3770 Series Lower Cylinder Mounting Kits can be ordered and are part numbers 3770M1-KIT570E and 3770M1-KIT577

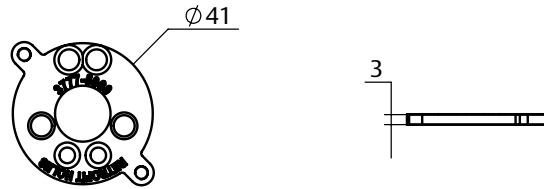

3777-KIT

DX Digital Kits

Part Number	Application
3772-DXKITSC	DX Digital Kit
3772-DXKOKITSC	DX Digital with Key Override Kit

DX Digital kits include: Digital codepad, mounting plate, codepad spindle, associated mounting screws and a latching adaptor.

Cylinders and door furniture (1800 or 2800 series) must be ordered separately.

Warning:

The MkI Latching Adaptor (now part number 3770M1-ADAPTOR) can only be used with the MkI Selector Mortice Locks and the MkII Latching Adaptor (3770M2-ADAPTOR) can only be used with MkII Selector Mortice Locks.

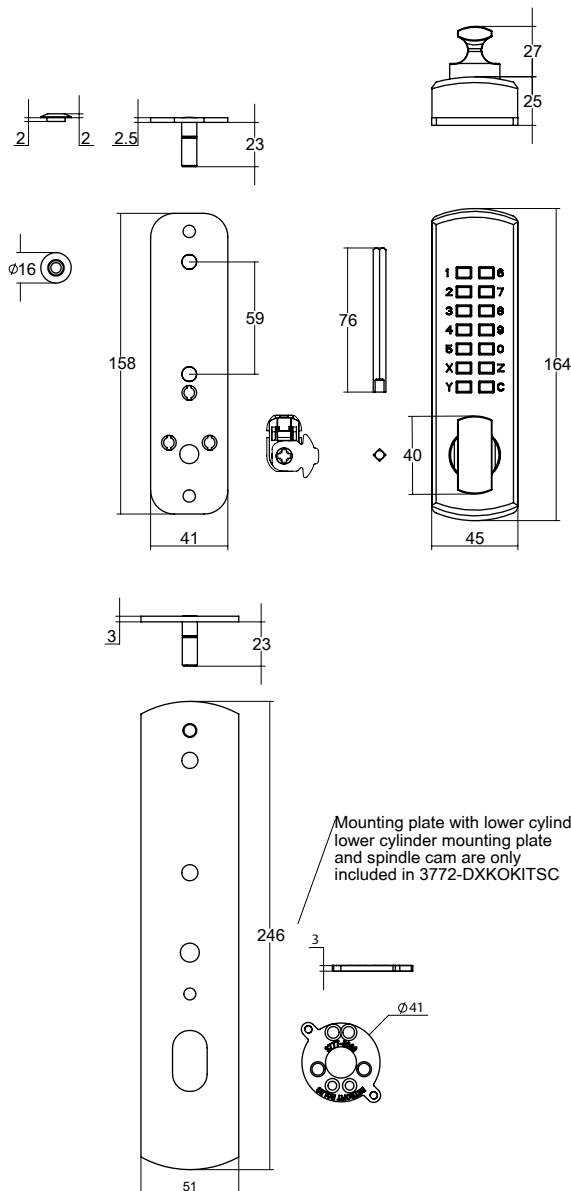

Selector® 3770 Series Accessories

Alternative Finish Kits

Part Number	Finish
3772-FINKITCP*	Chrome Plate
3772-FINKITPB	Polished Brass
3772-FINKITPC	Powder Coat

Finish kits include: Strike, faceplate and screws.
 For 3774 Passage Latch, please specify 3774FINKITXX,
 where XX designates finish.
 *Screws not included.

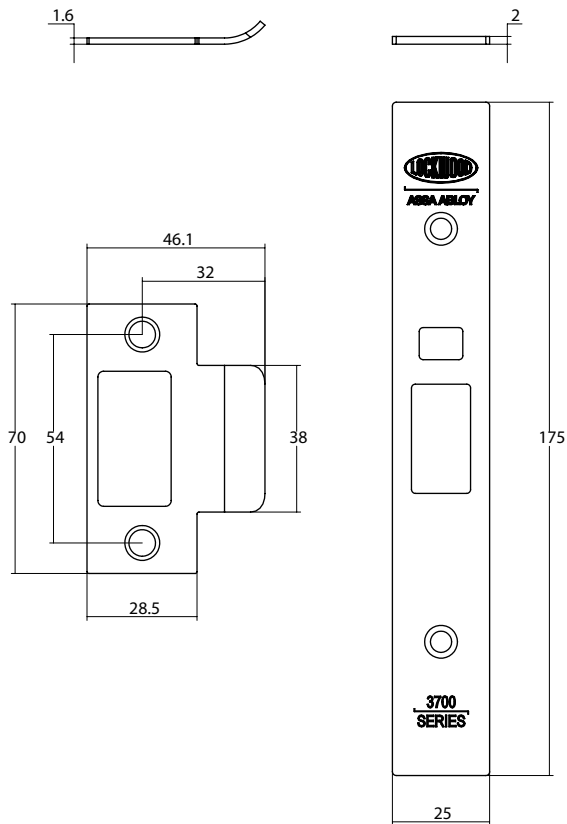

Fire Rated (4hr) Rebate Kits

Part Number	Lip Length A
3772-RK32XX	32mm
3772-RK46XX	46mm

Rebate kits to suit standard 13mm rebate.
 To order, add finish code to part number.
 XX designates finish.
SS - Stainless Steel, **CP** - Chrome Plate, **PB** - Polished Brass

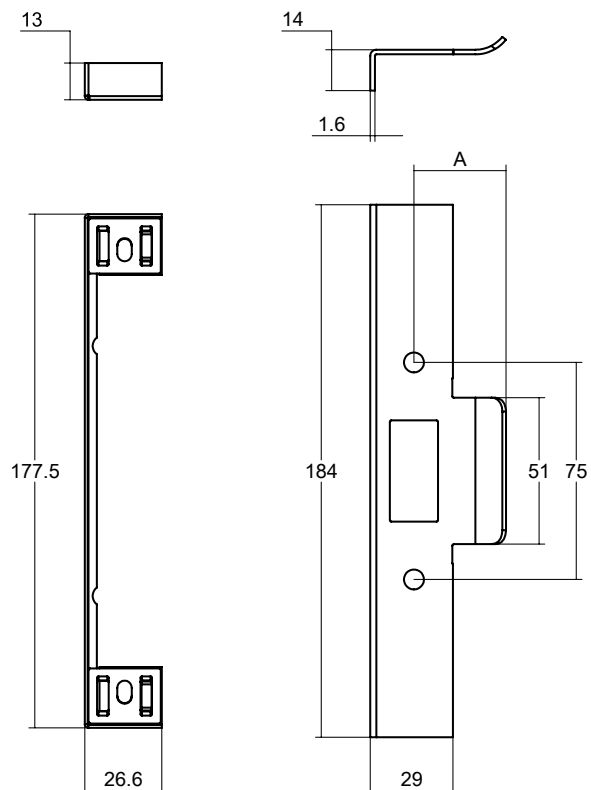

Notes:
 For questions concerning our fire rated products, their specifications and their utilization please
 contact ASSA ABLOY or relevant Fire Door Manufacturer.

Selector[®] 3770 Series Accessories

Aluminium Door Fixing Kit

Part Number	Finish
3772-AFKITSS*	Stainless Steel
3772-AFKITCP*	Chrome Plate
3772-AFKITPC	Powder Coat

For 3774 Passage Latch, please specify 3774-AFKITXX, where XX designates finish.

*Faceplate screws not included

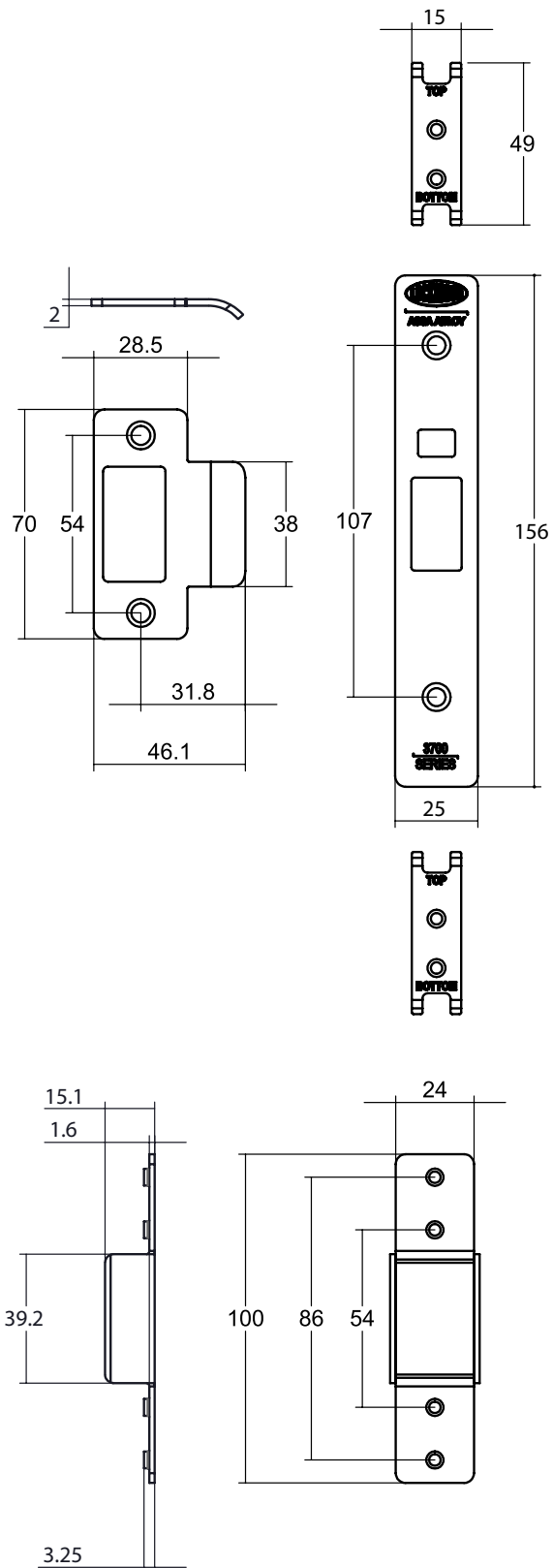

Selector[®] 3770 Series Accessories

Short/Extended Lipped Strikes

Part Number	Lip Length A	Lip Length B
3772-STK25XX	25.4mm	39.3mm
3772-STK32XX	32mm	46.1mm
3772-STK43XX	43.5mm	57.8mm
3772-STK47XX	47.5mm	61.8mm
3772-STK60XX*	60mm	74.2mm

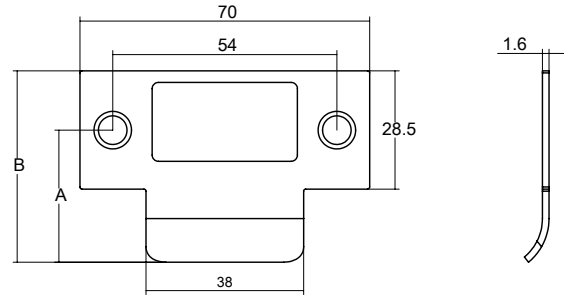

To order, add finish code to part number.

XX designates the finish.

SS - Stainless Steel, **CP** - Chrome Plate, **PB** - Polished Brass

*Only available in Stainless Steel (**SS**) finish.

ES2100 Electric Strike Faceplate

Part Number	Application
3772-2100SS	To suit 3770 Series
3772AF-2100SS*	To suit 3770 Series with Aluminium Door Fixing

To work in conjunction with the Lockwood Series ES2100 electric strike for door position monitoring.

* Can be used directly with a 3772SS primary lock

- No additional AF fixing kit is required.

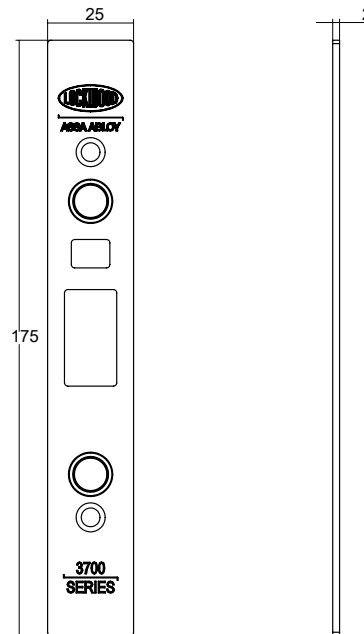

Security Faceplate Screw Kit

Part Number	Application
3772-SECKIT	To suit 3770 Series

Kit contains two replacement faceplate screws with tamper resistant TR20 torx drive heads.

Selector® 3770 Series Accessories

Mortice Lock Spindles

Part Number	Pack Size	Length "A"	Door Thickness	
			Min	Max
SP3570-5018	10	33mm	32	50
SP3570-5228	1	45mm	50	75
SP3570-5238	1	58mm	75	100
SP3570-5258	1	108mm	100	200

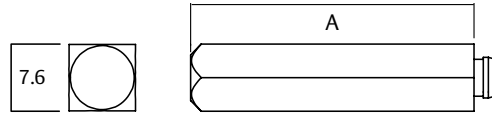

Single Cylinder Assemblies

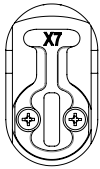

"X7" Cam Cylinder
570C4/X7

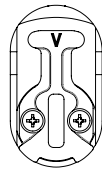

"V" Cam Cylinder
570C4/V



3777 Lower Cylinder
with Spindle Cam
570EC4/77

Cylinder Cams

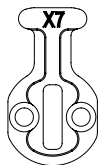

"X7" Cam
SP3700/X7CAM

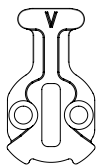

"V" Cam
SP3700/VCAM

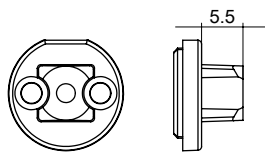

3777 Spindle Cam
SP3777/CAM

Adaptors

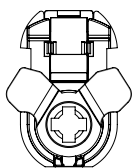

Locking Adaptor
3772-ADAPTOR

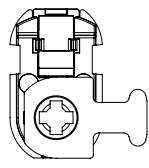

Latching Adaptor
3770M1-ADAPTOR

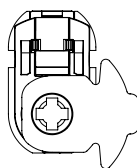

Latching Adaptor
3770M2-ADAPTOR

Warning:

The MkI Latching Adaptor (now part number 3770M1-ADAPTOR) can only be used with the MkI Selector Mortice Locks and the MkII Latching Adaptor (3770M2-ADAPTOR) can only be used with MkII Selector Mortice Locks.

Selector® 3770 Series Cam and Adaptors Function Chart

Selector® 3770 Series Cam and Adaptors Function Chart

Selector® 3770 Series	Function Description	Primary Lock	Outside Cylinder Cam/Adaptor	Inside Cylinder Cam/Adaptor	Kit
Selector® 3770 Nightlatches					
3770SS	Nightlatch Primary Lock	3770SS	-	-	
3770-TSS	Nightlatch with Turn	3770TSS	-	3770M2-ADAPTOR	
3770X-SS	Nightlatch with Cylinder	3770SS	X7	-	
3770XTSS	Nightlatch with Cylinder and Turn	3770TSS	X7	3770M2-ADAPTOR	
3770XXSS	Nightlatch with Double Cylinder	3770SS	X7	X7	
Selector® 3772 Escape Locks					
3772SS	Escape Primary Lock	3772SS	-	-	
3772-SS	Escape Lock	3772SS	-	-	
3772V-SS	Anti-vandal Escape Lock	3772SS	V	-	
3772VTSS	Anti-vandal Escape Lock with Turn	3772TSS	V	3772-ADAPTOR	
3772X-SS	Key Entry Escape Lock	3772SS	X7	-	
3772XTSS	Key Entry Escape Lock with Turn	3772TSS	X7	3772-ADAPTOR	
3772-VSS	Escape Lock with Internal Cylinder	3772SS	-	V	
3772-TSS	Escape Lock with Turn	3772TSS	-	3772-ADAPTOR	
3772VSS	Anti-vandal Escape Lock with Internal Cylinder	3772SS	V	V	
3772XVSS	Key Entry Escape Lock with Internal Cylinder	3772SS	X7	V	
3772-TASS	Anti-lockout Escape Lock with Turn	3772TSS	-	3772-ADAPTOR	
3772VTASS	Anti-lockout Anti-vandal Escape Lock with Turn	3772TSS	V	3772-ADAPTOR	
3772V-HSS	Holdback Anti-vandal Escape Lock	3772SS	V	-	
3772VTHSS	Holdback Anti-vandal Escape Lock with Turn	3772TSS	V	3772-ADAPTOR	
3772XVHSS	Holdback Key Entry Escape Lock with Internal Cylinder	3772SS	X7	V	
Selector® 3774 Passage Latch					
3774SS	Passage Latch	3774SS	-	-	
Selector® 3774 Combination Locks					
3774VTSS	Anti-vandal Lock with Turn	3772TSS	V	3772-ADAPTOR	
3774VSS	Anti-vandal Lock with Internal Cylinder	3772SS	V	V	
3774XVSS	Key Entry Lock with Internal Cylinder	3772SS	X7	V	
3774XXSS	Key Entry Double Cylinder Lock	3772SS	X7	X7	
3774-TSS	Combination Lock with Turn	3772TSS	-	3772-ADAPTOR	
3774-TASS	Anti-lockout Combination Lock with Turn	3772TSS	-	3772-ADAPTOR	
3774VTASS	Anti-lockout Anti-vandal Lock with Turn	3772TSS	V	3772-ADAPTOR	
3774VASS	Anti-lockout Anti-vandal Lock with Internal Cylinder	3772SS	V	V	
3774VTHSS	Holdback Anti-vandal Lock with Turn	3772TSS	V	3772-ADAPTOR	
3774VHSS	Holdback Anti-vandal Lock with Internal Cylinder	3772SS	V	V	
3774XVHSS	Holdback Key Entry Lock with Internal Cylinder	3772SS	X7	V	
Selector® 3777 Dual Entry Locks					
3777X-SS	Dual Entry Lock	3772SS	X7, 3777 SPINDLE CAM	-	3777-KIT
3777V-SS	Dual Entry Lock with Lower Cylinder Lockout	3772SS	V, 3777 SPINDLE CAM	-	3777-KIT

Selector® 3770 Series Cam and Adaptors Function Chart

Selector® 3770 Series Cam and Adaptors Function Chart

Selector® 3770 Series	Function Description	Primary Lock	Outside Cylinder Cam/Adaptor	Inside Cylinder Cam/Adaptor	Kit
Privacy Locks					
3772-TSS	Escape Privacy Lock	3772TSS	-	3772-ADAPTOR	
3772-TASS	Anti-lockout Escape Privacy Lock	3772TSS	-	3772-ADAPTOR	
3774-TSS	Privacy Lock	3772TSS	-	3772-ADAPTOR	
3774-TASS	Anti-lockout Privacy Lock	3772TSS	-	3772-ADAPTOR	
3777-TSS	Key Entry Privacy Lock	3772TSS	3777 SPINDLE CAM	3772-ADAPTOR	3777-KIT
3777-TASS	Key Entry Anti-lockout Privacy Lock	3772TSS	3777 SPINDLE CAM	3772-ADAPTOR	3777-KIT
Selector® 3772 DX Digital Locks					
3772DX-SS	DX Digital Mortice Lock	3772SS	3770M2-ADAPTOR	-	3772-DXKITSC
3772DXVHSS	DX Digital Mortice Lock with Holdback by Cylinder	3772SS	3770M2-ADAPTOR	V	3772-DXKITSC
3772DXKO-SS	Key Override DX Digital Mortice Lock	3772SS	3770M2-ADAPTOR, 3777 SPINDLE CAM	-	3772-DXKOKITSC
3772DXKOVHSS	Key Override DX Digital Mortice Lock with Holdback by Cylinder	3772SS	3770M2-ADAPTOR, 3777 SPINDLE CAM	V	3772-DXKOKITSC

Notes: Items in Italics are Primary locks and can be purchased from ASSA ABLOY. Purchased configurations include adaptors as required. Cylinders must be ordered separately.

Synergy Series Conversion Chart

Synergy Series Conversion Chart

Synergy Series	Selector® 3770 Series	Function Description	Note
Nightlatches			
3570SC	3770SS	Nightlatch Primary Lock	
3570-T#SC	3770-TSS	Nightlatch with Turn	
3570X-#SC	3770X-SS	Nightlatch with Cylinder	
3570XT#SC	3770XTSS	Nightlatch with Cylinder and Turn	
3570XX#SC	3770XXSS	Nightlatch with Double Cylinder	
Escape Locks			
3572SC	3772SS	Escape Primary Lock	
3572EA#SC	3772-TASS	Anti-lockout Escape Privacy Lock	
3572M-#SC	3772V-SS	Anti-vandal Escape Lock	V cam has the functionality of locking lock and retracting bolt without an adaptor.
3572-T#SC	3772-TSS	Escape Lock with Turn	
3572WA#SC	3772VTASS	Anti-lockout Anti-vandal Escape Lock with Turn	V cam has the functionality of locking lock just as the W cam. V cam also retracts bolt after unlocking lock.
3572WT#SC	3772VTSS	Anti-vandal Escape Lock with Turn	V cam has the functionality of locking lock just as the W cam. V cam also retracts bolt after unlocking lock.
3572X-#SC	3772X-SS	Key Entry Escape Lock	X7 cam has the functionality of retracting bolt and locking lock. Does not have unlocking functionality.
3572XA#SC	3772VTASS	Anti-lockout Anti-vandal Escape Lock with Turn	V cam has the functionality of locking lock and retracting bolt without an adaptor.
3572XT#SC	3772XTSS	Key Entry Escape Lock with Turn	X7 cam has the functionality of retracting bolt and locking lock. Does not have unlocking functionality.
3572XZ#SC	3772XVSS	Key Entry Escape Lock with Internal Cylinder	V cam has the functionality of locking lock just as the Z cam. V cam also retracts bolt after unlocking lock. X7 cam has the functionality of retracting bolt and locking lock. Does not have unlocking functionality.
3572-Z#SC	3772-VSS	Escape Lock with Internal Cylinder	V cam has the functionality of locking lock just as the Z cam. V cam also retracts bolt after unlocking lock.
3572Z-#SC	3772V-SS	Anti-vandal Escape Lock	V cam has the functionality of locking lock just as the Z cam. V cam also retracts bolt after unlocking lock.
Combination Locks			
3574SC	3774SS	Passage Latch	
3574ET#SC	3774-TSS	Privacy Lock	
3574WT#SC	3774VTSS	Anti-vandal Lock with Turn	V cam has the functionality of locking lock just as the W cam. V cam also retracts bolt after unlocking lock.
3574XX#SC	3774XXSS	Key Entry Double Cylinder Lock	X7 cam has the functionality of retracting bolt and locking lock. Does not have unlocking functionality.
3574XZ#SC	3774XVSS	Key Entry Lock with Internal Cylinder	V cam has the functionality of locking lock just as the Z cam. V cam also retracts bolt after unlocking lock. X7 cam has the functionality of retracting bolt and locking lock. Does not have unlocking functionality.
3574-Z#SC	3774-VSS	Combination Lock with Internal Cylinder	V cam has the functionality of locking lock just as the Z cam. V cam also retracts bolt after unlocking lock.
3574Z-#SC	3774V-SS	Anti-vandal Combination Lock	V cam has the functionality of locking lock just as the Z cam. V cam also retracts bolt after unlocking lock.
3574ZZ#SC	3774VSS	Anti-vandal Lock with Internal Cylinder	V cam has the functionality of locking lock just as the Z cam. V cam also retracts bolt after unlocking lock.
Dual Entry Locks			
3577SC			3772SS primary lock can be converted to a dual entry lock with the 3777M1-KIT570E kit.
3577EA#SC	3777-TASS	Key Entry Anti-lockout Privacy Lock	
3577M-#SC	3777V-SS	Dual Entry Lock with Lower Cylinder Lockout	V cam has the functionality of locking lock and retracting bolt without an adaptor.
3577X-#SC	3777X-SS	Dual Entry Lock	X7 cam has the functionality of retracting bolt and locking lock. Does not have unlocking functionality.
Holdback Locks			
3578SC			Holdback functionality is available in 3772 primary lock.
3578M-#SC	3772V-HSS	Holdback Anti-vandal Escape Lock	V cam has the functionality of locking lock and retracting bolt without an adaptor.
3578WT#SC	3772VTHSS	Holdback Anti-vandal Escape Lock with Turn	V cam has the functionality of locking lock just as the W cam. V cam also retracts bolt after unlocking lock.
3578Z-#SC	3772V-HSS	Holdback Anti-vandal Escape Lock	V cam has the functionality of locking lock just as the Z cam. V cam also retracts bolt after unlocking lock.
3578XZ#SC	3772XVHSS	Holdback Key Entry Escape Lock with Internal Cylinder	V cam has the functionality of locking lock just as the Z cam. V cam also retracts bolt after unlocking lock. X7 cam has the functionality of retracting bolt and locking lock. Does not have unlocking functionality.

Synergy Series Conversion Chart

Synergy Series Conversion Chart

Synergy Series	Selector® 3770 Series	Function Description	Note
Extended Lip Strikes			
SP3570-4053SSS	3772-STK25SS	3772 SHORT LIP STRIKE 25.4MM LIP	
SP3570-4153CP	3772-STK25CP	3772 SHORT LIP STRIKE 25.4MM LIP	
SP3570-4153PB	3772-STK25PB	3772 SHORT LIP STRIKE 25.4MM LIP	
SP3570-5053SSS	3772-STK32SS	3772 STANDARD STRIKE 32MM LIP PK=10	
SP3570-5153CP	3772-STK32CP	3772 STANDARD STRIKE 32MM LIP PK=10	
SP3570-5153PB	3772-STK32PB	3772 STANDARD STRIKE 32MM LIP PK=10	
SP3570-5253SSS	3772-STK43SS	3772 LONG LIP STRIKE 43.5MM LIP	
SP3570-5353CP	3772-STK43CP	3772 LONG LIP STRIKE 43.5MM LIP	
SP3570-5353PB	3772-STK43PB	3772 LONG LIP STRIKE 43.5MM LIP	
SP3570-5453SSS	3772-STK47SS	3772 LONG LIP STRIKE 47MM LIP	
SP3570-5653CP	3772-STK47CP	3772 LONG LIP STRIKE 47MM LIP	
SP3570-5653PB	3772-STK47PB	3772 LONG LIP STRIKE 47MM LIP	
SP3570-5960SS	3772-STK60SS	3772 LONG LIP STRIKE 60MM LIP	
SP500-252ZP	3772-STKBOX	3772 STRIKE BOX PK=10	
Rebate Kits			
3P72-RK32SS	3772-RK32SS	3772 SERIES REBATE KIT- 32MM LIP STRIKE	
3P72-RK32CP	3772-RK32CP	3772 SERIES REBATE KIT- 32MM LIP STRIKE	
3P72-RK32PB	3772-RK32PB	3772 SERIES REBATE KIT- 32MM LIP STRIKE	
3P72-RK46SS	3772-RK46SS	3772 SERIES REBATE KIT- 46MM LIP STRIKE	
3P72-RK46CP	3772-RK46CP	3772 SERIES REBATE KIT- 46MM LIP STRIKE	
3P72-RK46PB	3772-RK46PB	3772 SERIES REBATE KIT- 46MM LIP STRIKE	

Selector® 3770 Series Cylinder Mortice Locks Functioning Matrix

Functioning Matrix

Sample part number 3772VTASS is made up of seven elements.

The description of this part number is an Anti-lockout Anti-vandal escape lock with cylinder and turn in satin stainless steel finish. Choose your product by selecting an option from each element.

Backset	Series	Platform	Function	Sub Function	Lock Function Setting	Finish	
3	7	7	2	VT	A	SS	
Backset			Sub Function				
60mm	3	e.g. Outside Inside		Neutral			
89mm	4	V T		Anti-lockout A			
127mm	5	Locking and Latching Cylinder with V Cam V		Holdback H			
Series			Latching Cylinder with X7 Cam X		Finish		
Selector® Series Mortice Locks	7	Turnbutton Adaptor T		Stainless Steel SS			
		No Sub Function -					
Platform			DX Digital DX				
Standard Backset	7	DX Digital with Key Override DXKO					
Functions							
Nightlatch					0		
Escape Lock					2		
Combination Lock					4		
Dual Entry Lock					7		

Code

1. Backset: Nominate backset as required, for example 3 = 60mm backset.

2. Function: Select function, for example 772 = Escape Lock

3. Sub Function: Determine sub function requirements for both exterior and interior.

For example:

Exterior – Locking function required – specify V (cylinder).

Interior – Turnknob function required – specify T

(turnbutton adaptor).

4. Locking Function Setting: Determine lock function requirements.

For example:

Anti-lockout - Specify A

5. Finish: Select appropriate finish, e.g. SS

Other finishes available by specifying finish kits.



Selector® 3780 Mkl Series Mortice Locks

Selector® 3780 Series Cylinder Mortice Locks

A comprehensive range of cylinder mortice locks for narrow stile hinged doors, suitable for heavy duty use in industrial and commercial buildings, shop fronts, clubs, schools, hospitals, hotels and similar buildings.

Benefits

- Easy red/green function setting
- All lock settings are made from under the faceplate allowing for simple in-door configuration
- Standard primary locks include anti-lockout and holdback capabilities
- Improved cylinder functions including lock/unlock and retract latch as standard
- Reduced range of cylinder cams and turn adaptors relative to other commonly available commercial cylinder mortice locks

Features and Specifications

The Australian designed and made Selector® 3780 Series Short Backset Cylinder Mortice Locks are made from quality materials to meet high durability and strength requirements.

Case and Faceplates

- High purity zinc alloy material cases with stainless steel chassis plates. Stainless steel faceplates provided as standard.
- Brass faceplates are available for alternative finishes

Backset

23mm standard backset. Extended backsets 25.4mm, 30mm and 38mm are available, refer to function matrix (Page 76)

Latch Bolts

- Latch bolts are made with stainless steel, 15mm in size
- Deadlatching is achieved by an auxiliary stainless steel latch bolt
- Reversible for both left and right hand doors, opening in or opening out whilst lock is in door
- Electric strike compatibility
- Separate auxiliary bolt moves into lock case simultaneously with latch bolt
- Radius bolt provides greater deadlatch throw and smoother closing action

Cylinder Retaining Pin

- Hard-drawn spring steel wire, corrosion protected

Door Thickness

- Metal doors: 35 to 50mm
- Suits hollow-style aluminium door sections with 38mm minimum internal depth
- Timber doors: 32 to 50mm
- Specify 3782-TFKIT for timber door fixing kit to convert an aluminium fix lock suit timber door fixing. The timber door fixing kit includes a long faceplate, strike and screws to suit a timber door and jamb

Cylinder

Requires standard Lockwood oval shaped brass cylinders and brass barrels. Lockwood cylinders include bump resistant five pin tumbler mechanism.

Functions require the use of different cams and adaptors.

Keying

Restricted Special Keying

Lockwood locks can be keyed to a number of controlled and/or specially keyed systems. These range from legally protected keys to protect against unauthorised duplication and can also include specially designed keying systems such as master key systems. This allows for different levels of mechanical access control.

Please refer to assaabloy.com.au for keying systems or contact your local sales office or customer service for specific information.

Security

All Selector® 3780 Series Cylinder Mortice Locks conform with Level S7 (Physical Security) Australian Lock Standard (AS-4145.2-2008). Conforms to Level S8 (Physical Security) when fitted with door furniture and anti-drill cylinder.

Durability

All Selector® 3780 Series Cylinder Mortice Locks conform with Level D8 (Durability) Australian Lock Standard (AS 4145.2-2008).

Anti-Corrosion

All Selector® 3780 Series Cylinder Mortice Locks conform with Level C6 (168 hours) Australian Lock Standard (AS4145.2-2008).

Door Clearance

To ensure correct functioning of the deadlatching mechanism and security for all locks, the clearance between the door and frame should be no less than 3mm. The deadlatching will operate up to 8mm door clearance, however door clearances over 5mm are not recommended.

Standard Finishes

Stainless Steel SS

Extended Cylinders

Modular cylinder extensions are available for thicker doors.

Rebate

Rebate kits to suit 13mm standard rebate are available. Only suitable for use with 30mm and 38mm backset locks.

Electric Strikes

Lockwood offers a wide range of electric strikes which are compatible with the Selector® 3780 Series Mortice Lock.

For further details refer to lockweb.com.au

S7 HIGH SECURITY

D8 DURABILITY

ANTI-CORROSION

Selector® 3780 Series Cylinder Mortice Locks

1. Multi-function Lock

The new Selector® 3780 Series Mortice Lock was designed to incorporate the full range of lock functions into one primary lock. This reduces stock line items. All functions can be configured by adjusting the hub setting selector, anti-lockout selector as well as using cylinder cams and turn adaptors.

2. Hub Setting Selection

Hub settings can be adjusted via the Selector® 3780 series hub selector located under the faceplate of the mortice lock. The hub setting allows for three functions: Passage, Combination, or Escape function. This is done by rotating the dial with a 4mm flat blade screwdriver.

RED - Handle is lockable. Only opened by handle when locking bar is unlocked (up).

GREEN - Opened by handle at all times.

3. Anti-lockout Selection

Anti-lockout function can now be selected via a switch under the faceplate of the mortice lock. This is done by depressing on the anti-lockout indicated part of the switch with a 4mm flat blade screwdriver. Clearance between door and frame should not be over 5mm to ensure anti-lockout mechanism functions correctly.

4. Case Assembly

Zinc diecast body with stainless steel chassis plates for improved strength.

5. Backsets

- Standard Backset - 23mm

Extended backsets 25.4, 30 and 38mm are available (Refer to Ordering Procedure on page 79)

6. Cylinder/Adaptor Retention

"Slip Pin" Cylinder/Adaptor fixing method, which allows attachment to the lock case by inserting a non-threaded cylindrical pin through the front of the lock case.

7. Cylinder Assembly

Five pin tumbler mechanism. Standard Lockwood oval shaped, brass cylinders and brass barrels. Only two newly designed cams needed for all lock functions.

X7 Cam - Retracts latch bolt with additional ability of locking the locking bar.

V Cam - Locks and unlocks the locking bar. Also retracts latch bolt after unlocking lock.

8. Synergy Retrofit

The Selector® 3780 Series Mortice Lock is designed to have an equivalent case size as the Synergy Series Mortice Lock to ensure retrofitability.

9. Lock Fixing and Kits

The Selector® 3780 Series primary lock is designed for aluminium doors. Various kit conversions are available for timber door applications, alternative finishes as well as dual entry and DX digital locksets.

Holdback Function

Lock is always holdback capable, no setting is required. Holdback can be activated at any time - unless anti-lockout is selected.



Selector® 3782 Short Backset Escape Locks



Description

These locks have various latching functions operated generally by key or handle outside and by turnknob, key or handle inside. These locks comply with building regulations for single-action escape doors.

Product Details

Furniture	Compatible with Lockwood 4800 and 5800 Series Furniture. Refer to lockweb.com.au for further details.
Latch	Deadlatch only.
Standard Finishes	Stainless Steel (SS) Other finishes available via finish kit conversions.

Selector® 3782 Short Backset Escape Locks

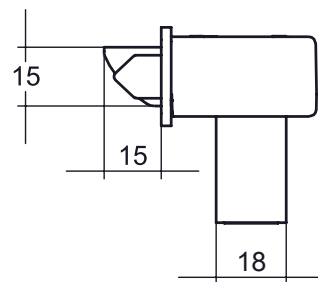
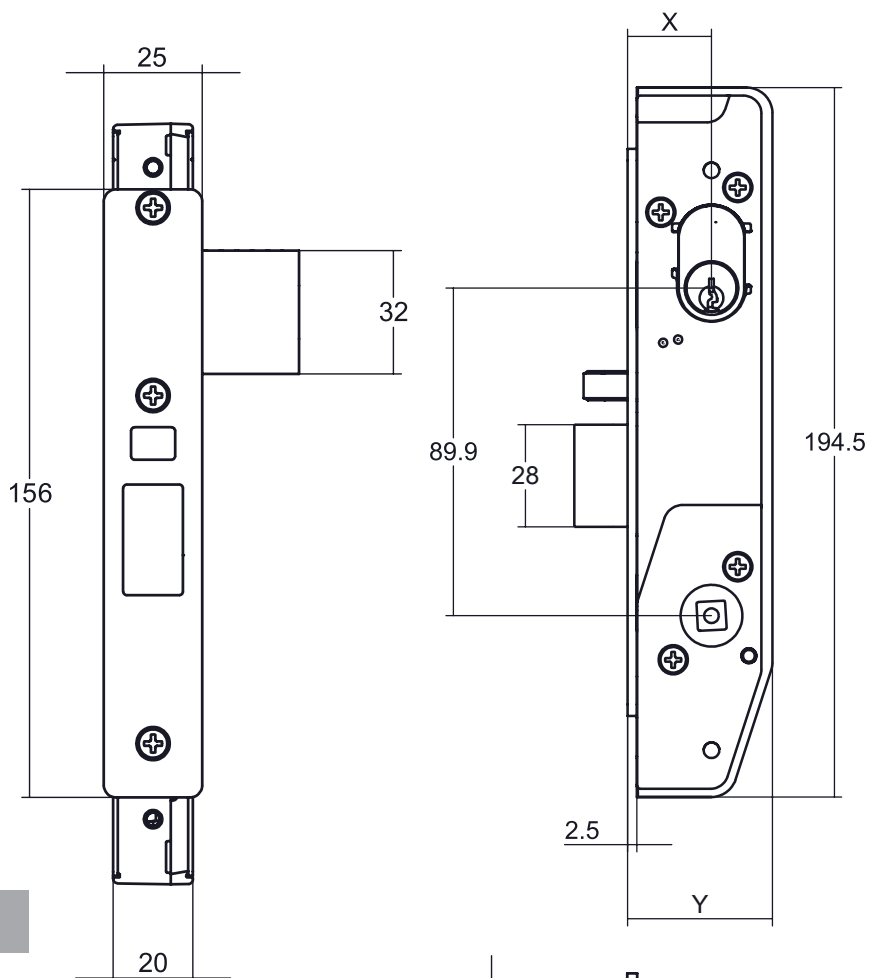

Selector® 3782 Short Backset Escape Locks

Part Number	3782	4782	5782	6782
Dimension X	23	25.4	30	38
Dimension Y	40	42.4	47	55
Minimum internal depth of door	40	43	47	55

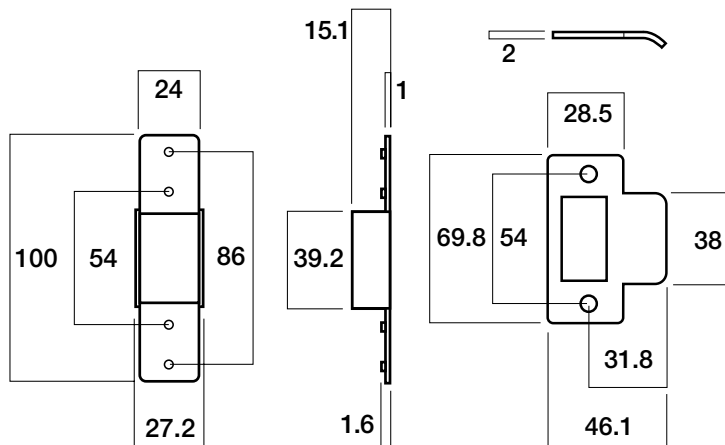

Selector® 3782 Short Backset Escape Locks

Escape Lock

Part Number 3782--

Outside: Handle always rigid.

Inside: Opened by handle at all times

This function requires the locking bar to be positioned in the locked position once lock is set.

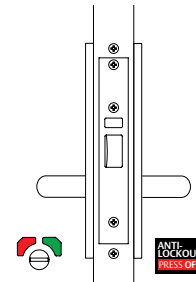

Anti-vandal Escape Lock[#]

Part Number 3782V-

Single cylinder.

Outside: Opened by handle when unlocked. Key locks or unlocks outside handle and retracts bolt after unlocking lock.

Inside: Opened by handle at all times.

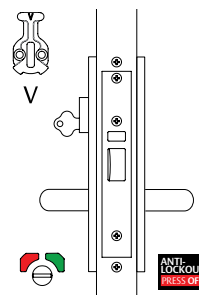

Anti-vandal Escape Lock with Turn[#]

Part Number 3782VT

Cylinder and turnknob.

Outside: Opened by handle when unlocked. Key locks or unlocks outside handle and retracts bolt after unlocking lock.

Inside: Opened by handle at all times. Turnknob locks or unlocks outside handle.

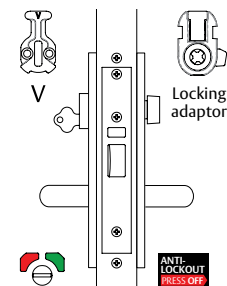

Key Entry Escape Lock

Part Number 3782X-

Single cylinder.

Outside: Opened by key at all times. Handle always rigid.

Inside: Opened by handle at all times.

This function requires the locking bar to be positioned in the locked position once lock is set.

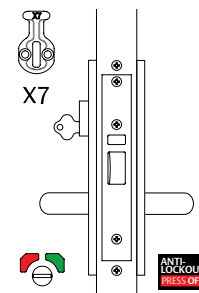

Notes:

All drawings shown are in right hand configuration. Part numbers shown above are for 23mm backset lock, if 25.4mm is required substitute 3 for 4 i.e. 4782, or if 30mm or 38mm lock is required, substitute 5 for 5 or 6 respectively i.e. 5782, 6782

*Anti-lockout - Closing the door or retracting latch bolt unlocks the lock, preventing lockout situations.

#Latch bolt can be held within the lock. Lock function recommended for use in holdback application.

Legend

Hub Setting



Anti-lockout Selection



Cam or Adaptor



X7

Selector® 3782 Short Backset Escape Locks

Key Entry Escape Lock with Turn#

Part Number 3782XT

Cylinder and turnknob.

Outside: Opened by key at all times. Opened by handle when unlocked. Key locks outside handle.

Inside: Opened by handle at all times. Turnknob locks or unlocks outside handle.

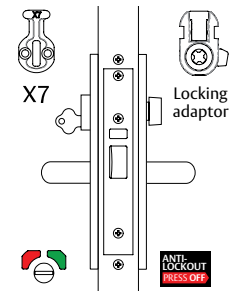

Escape Lock with Internal Cylinder#

Part Number 3782-V

Cylinder inside.

Outside: Opened by handle when unlocked.

Inside: Opened by handle at all times. Cylinder locks or unlocks outside handle and retracts bolt after unlocking lock.

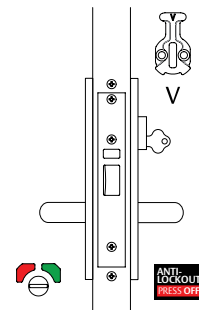

Escape Lock with Turn#

Part Number 3782-T

Turnknob inside.

Outside: Opened by handle when unlocked.

Inside: Opened by handle at all times. Turnknob locks or unlocks outside handle.

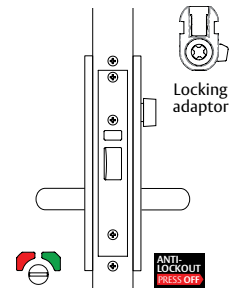

Key Entry Escape Lock with Internal Cylinder#

Part Number 3782XV

Double Cylinder.

Outside: Opened by key at all times. Opened by handle when unlocked. Key locks outside handle.

Inside: Opened by handle at all times. Key locks or unlocks outside handle and retracts bolt after unlocking lock.

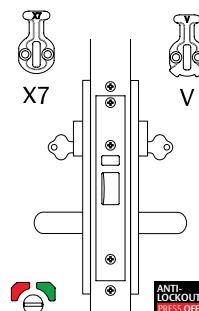

Notes:

All drawings shown are in right hand configuration. Part numbers shown above are for 23mm backset lock, if 25.4mm is required substitute 3 for 4 i.e. 4782, or if 30mm or 38mm lock is required, substitute 3 for 5 or 6 respectively i.e. 5782, 6782

*Anti-lockout - Closing the door or retracting latch bolt unlocks the lock, preventing lockout situations.

#Latch bolt can be held within the lock. Lock function recommended for use in holdback application.

Legend

Hub Setting



Anti-lockout Selection



Cam or Adaptor



Selector® 3782 Short Backset Escape Locks

Anti-lockout Escape Lock with Turn*

Part Number 3782-TA

Turnknob inside.

Outside: Opened by handle when unlocked.

Inside: Opened by handle at all times. Turnknob locks or unlocks outside handle.

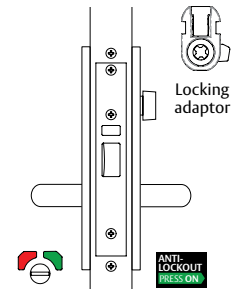

Anti-lockout Anti-vandal Escape Lock with Turn*

Part Number 3782VTA

Cylinder and turnknob.

Outside: Opened by handle when unlocked. Key locks or unlocks outside handle and retracts bolt after unlocking lock.

Inside: Opened by handle at all times. Turnknob locks or unlocks outside handle.

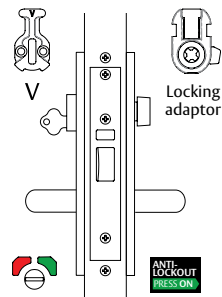

Notes:

All drawings shown are in right hand configuration. Part numbers shown above are for 23mm backset lock, if 25.4mm is required substitute 3 for 4 i.e. 4782, or if 30mm or 38mm lock is required, substitute 3 for 5 or 6 respectively i.e. 5782, 6782

*Anti-lockout - Closing the door or retracting latch bolt unlocks the lock, preventing lockout situations.

#Latch bolt can be held within the lock. Lock function recommended for use in holdback application.

Legend

Hub Setting



Anti-lockout Selection



Cam or Adaptor



Selector® 3784 Short Backset Combination Locks



Description

These locks have various latching functions operated generally by outside or inside handles, except when locked by key outside or by key or turnknob inside.

Product Details

Furniture	Compatible with Lockwood 4800 and 5800 Series Furniture. Refer to lockweb.com.au for further details.
Latch	Deadlatch only.
Standard Finishes	Stainless Steel (SS) Other finishes available via finish kit conversions.

Selector® 3784 Short Backset Combination Locks

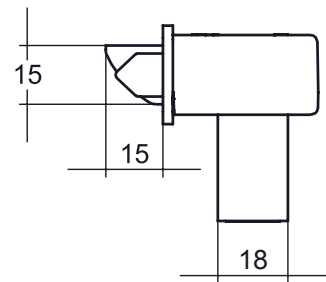
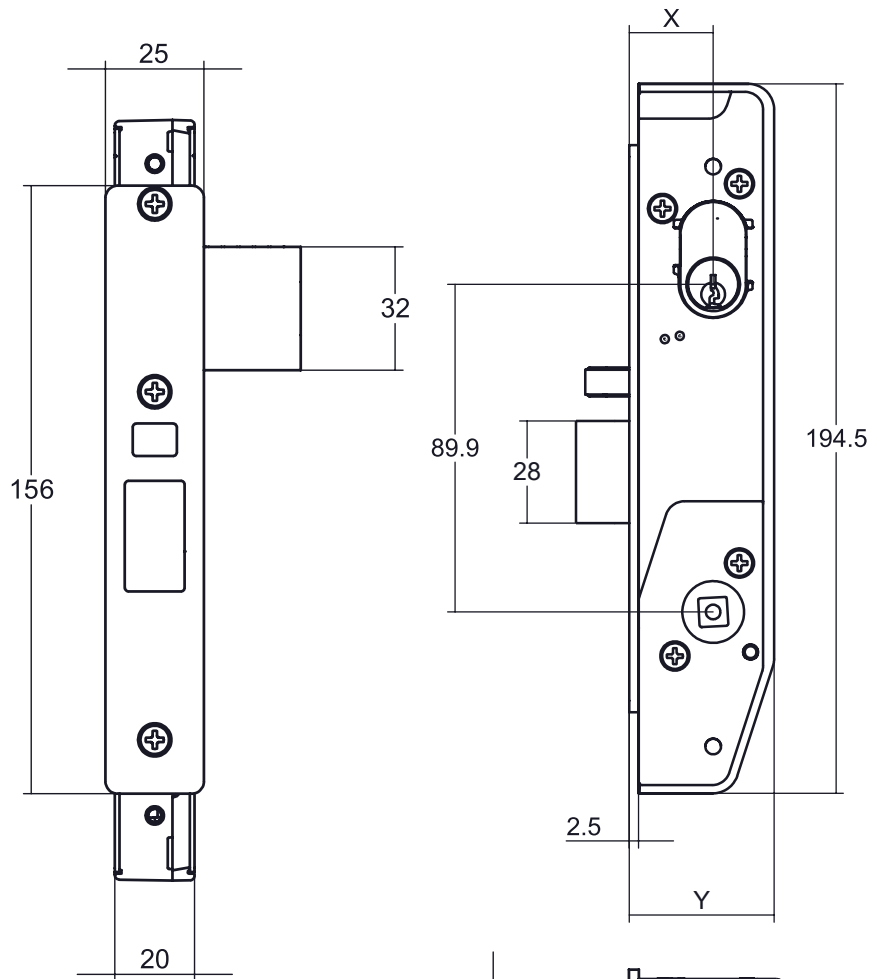

Selector® 3784 Short Backset Combination Locks

Part Number	3784	4784	5784	6784
Dimension X	23	25.4	30	38
Dimension Y	40	42.4	47	55
Minimum internal depth of door	40	43	47	55

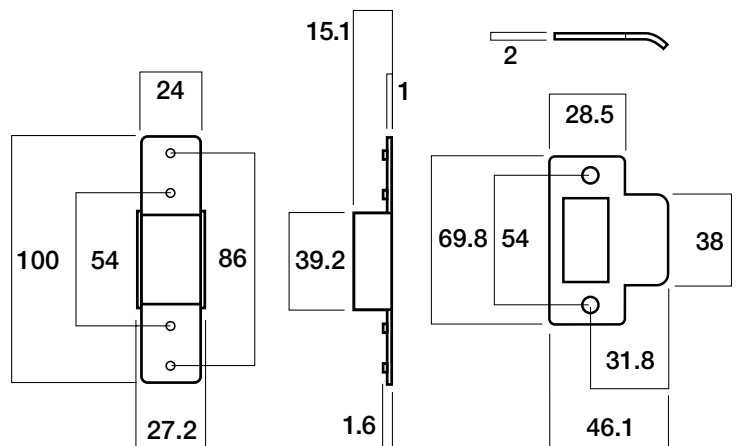

Selector® 3784 Short Backset Combination Locks

Passage Latch	
Part Number	3784

No locking function. Plainlatch only.
Outside: Opened by handle at all times.
Inside: Opened by handle at all times.

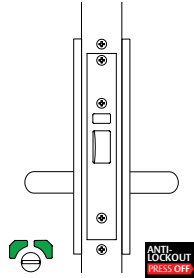

Anti-vandal Lock with Turn#	
Part Number	3784VT

Cylinder and turnknob.
Outside: Opened by handle when unlocked. Key locks or unlocks both handles and retracts bolt after unlocking lock.
Inside: Opened by handle when unlocked. Turnknob locks or unlocks both handles.

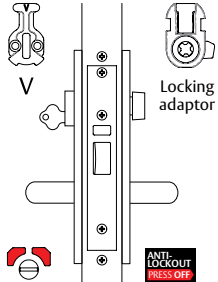

Anti-vandal Lock with Internal Cylinder#	
Part Number	3784VV

Double cylinder.
Outside: Opened by handle when unlocked. Key locks or unlocks both handles and retracts bolt after unlocking lock.
Inside: Opened by handle when unlocked. Key locks or unlocks both handles and retracts bolt after unlocking lock.

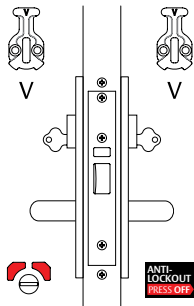

Key Entry Lock with Internal Cylinder#	
Part Number	3784XV

Double cylinder.
Outside: Opened by key at all times. Opened by handle when unlocked. Key locks both handles.
Inside: Opened by handle when unlocked. Key locks or unlocks both handles and retracts bolt after unlocking lock.

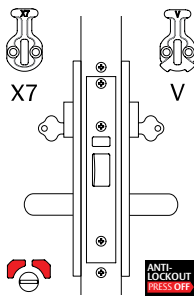

Notes:
 All drawings shown are in right hand configuration. Part numbers shown above are for 23mm backset lock, if 25.4mm is required substitute 3 for 4 i.e. 4784, or if 30mm or 38mm lock is required, substitute 3 for 5 or 6 respectively i.e. 5784, 6784
 *Anti-lockout - Closing the door or retracting latch bolt unlocks the lock, preventing lockout situations.
 #Latch bolt can be held within the lock. Lock function recommended for use in holdback application.

Legend	
Hub Setting	
Anti-lockout Selection	
Cam or Adaptor	

Selector® 3784 Short Backset Combination Locks

Key Entry Double Cylinder Lock

Part Number 3784XX

Double cylinder.

Outside: Opened by key at all times. Handle always rigid.

Inside: Opened by key at all times. Handle always rigid.

This function requires the locking bar to be positioned in the locked position once lock is set.

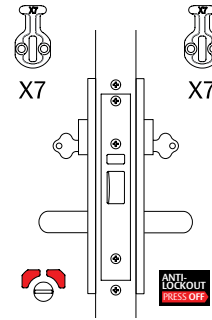

Combination Lock with Turn#

Part Number 3784-T

Turnknob inside.

Outside: Opened by handle when unlocked.

Inside: Opened by handle when unlocked. Turnknob locks or unlocks both handles.

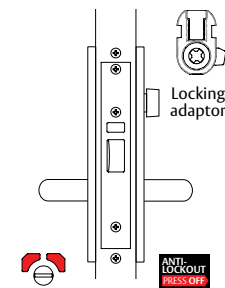

Anti-lockout Combination Lock with Turn*

Part Number 3784-TA

Turnknob inside.

Outside: Opened by handle when unlocked.

Inside: Opened by handle when unlocked. Turnknob locks or unlocks both handles.

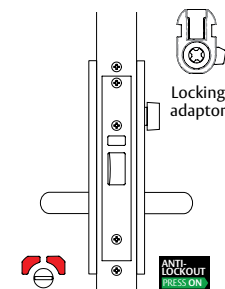

Anti-lockout Anti-vandal Lock with Turn*

Part Number 3784VTA

Cylinder and turnknob.

Outside: Opened by handle when unlocked. Key locks or unlocks both handles and retracts bolt after unlocking lock.

Inside: Opened by handle when unlocked. Turnknob locks or unlocks both handles.

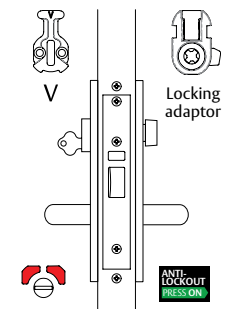

Notes:

All drawings shown are in right hand configuration. Part numbers shown above are for 23mm backset lock, if 25.4mm is required substitute 3 for 4 i.e. 4784, or if 30mm or 38mm lock is required, substitute 3 for 5 or 6 respectively i.e. 5784, 6784

*Anti-lockout - Closing the door or retracting latch bolt unlocks the lock, preventing lockout situations.

#Latch bolt can be held within the lock. Lock function recommended for use in holdback application.

Legend

Hub Setting



Anti-lockout Selection



Cam or Adaptor



Selector® 3784 Short Backset Combination Locks

Anti-lockout Anti-vandal Lock with Internal Cylinder*

Part Number 3784VVA

Double cylinder.

Outside: Opened by handle when unlocked. Key locks or unlocks both handles and retracts bolt after unlocking lock.

Inside: Opened by handle when unlocked. Key locks or unlocks both handles and retracts bolt after unlocking lock.

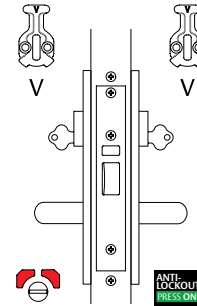

Notes:

All drawings shown are in right hand configuration. Part numbers shown above are for 23mm backset lock, if 25.4mm is required substitute 3 for 4 i.e. 4784, or if 30mm or 38mm lock is required, substitute 3 for 5 or 6 respectively i.e. 5784, 6784

*Anti-lockout - Closing the door or retracting latch bolt unlocks the lock, preventing lockout situations.

#Latch bolt can be held within the lock. Lock function recommended for use in holdback application.

Legend	
Hub Setting	
Anti-lockout Selection	
Cam or Adaptor	



Selector® 3787 Short Backset Dual Entry Locks



Description

Designed to enable third parties such as emergency services to enter specific areas by second cylinder without giving access to all locksets in the building and the ability to lockout keys with restricted access at certain times.

Product Details

Furniture	Compatible with Lockwood 4800 and 5800 Series Furniture. Refer to lockweb.com.au for further details.
Latch	Deadlatch only.
Standard Finishes	Stainless Steel (SS) Other finishes available via finish kit conversions.

Selector® 3787 Short Backset Dual Entry Locks

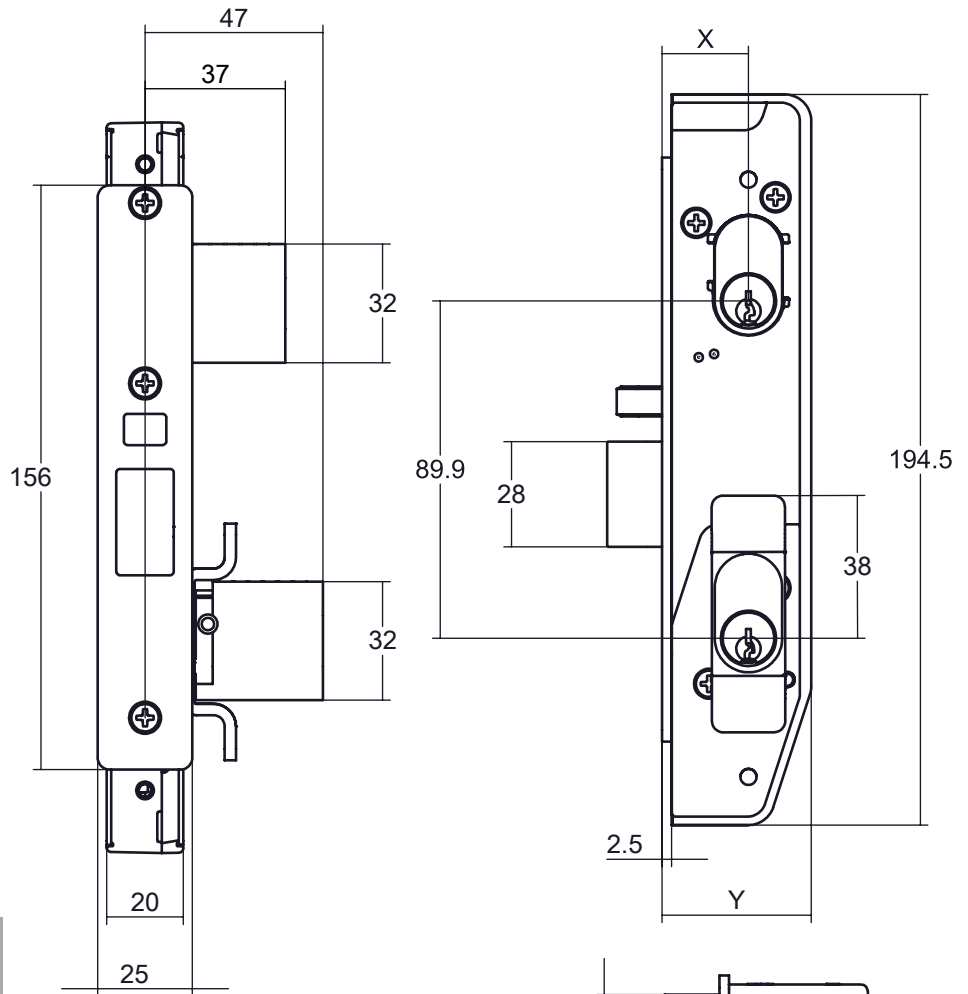

Selector® 3787 Short Backset Dual Entry Locks

Part Number	3787	4787	5787	6787
Dimension X	23	25.4	30	38
Dimension Y	40	42.4	47	55
Minimum internal depth of door	40	43	47	55

*Order by specifying 3782SS primary lock and 3787-KIT570E Dual Entry Kit. Cylinders must be ordered separately. Dual Entry Kit only suits 43 - 46mm door thickness.

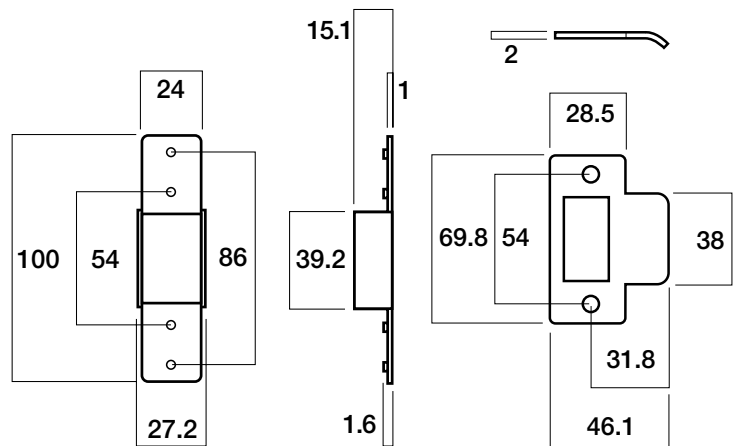
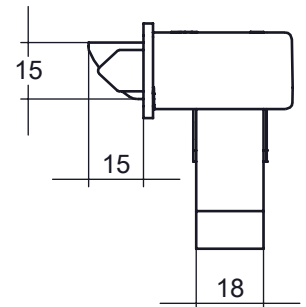

Selector® 3787 Short Backset Dual Entry Locks

Dual Entry Lock

Part Number 3787X-

Two cylinders outside.

Outside: Opened by key. Cylinders are keyed to differ.

Inside: Opened by handle at all times.

This function requires the locking bar to be positioned in the locked position once lock is set.

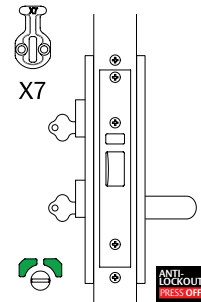

Dual Entry Lock with Lower Cylinder Lockout

Part Number 3787V-

Two cylinders outside.

Outside: Opened by key when unlocked. Upper cylinder key locks or unlocks lower cylinder and retracts bolt after unlocking lock. Cylinders are keyed to differ.

Inside: Opened by handle at all times.

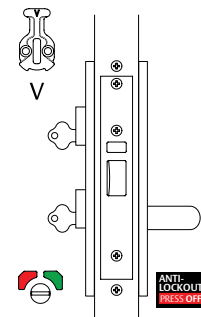

Notes:

All drawings shown are in right hand configuration. Part numbers shown above are for 23mm backset lock, if 25.4mm is required substitute 3 for 4 i.e. 4787, or if 30mm or 38mm lock is required, substitute 3 for 5 or 6 respectively i.e. 5787, 6787

Legend	
Hub Setting	
Anti-lockout Selection	
Cam or Adaptor	

Selector® 3782 Short Backset DX Digital Mortice Locks



Description

Lockwood DX Digital Locksets provide a mechanical method of keyless entry.

For extra security when under forced attack, the inbuilt clutching mechanism allows the outside turnknob to rotate without operating or damaging the lock.

The factory set 4 digit code is easily changed to any 4, 5 or 6 digit code using the code changing kit provided with each lock.

Lockwood Digital DX Locksets are designed to control access in commercial areas.

As the digital lockset utilizes mechanical operation, electrical wiring is not required.

Product Details

Door Thickness	32 to 50mm for timber doors. 35 to 50mm for metal doors
Finish	Codepad: Satin Chrome Brushed (SC) Mortice Lock: Stainless Steel (SS)
Codepad Assembly	High purity zinc alloy, 45mm wide, 164mm high, 52mm projection
Latch	Stainless steel with 15mm projection

Note: As suitability of lever will be influenced by the lock backset, refer to chart for Lever/Backset compatibility Lockwood Door Handle Catalogue. Lockwood 4800 and 5800 Series (ordered separately).

Backset

Open-out door: 23, 25.4, 30 and 38mm.
Open-in door: 38mm recommended.
Installation of 23, 25.4 or 30mm on open-in doors would require the door stop to be machined to clear the digital pad.

Inside Function

Opened by lever handle at all times.

Holdback Function

Holdback function is available, this requires the inclusion of an internal cylinder.

Selector® 3782 Short Backset DX Digital Mortise Locks



Exterior



Interior

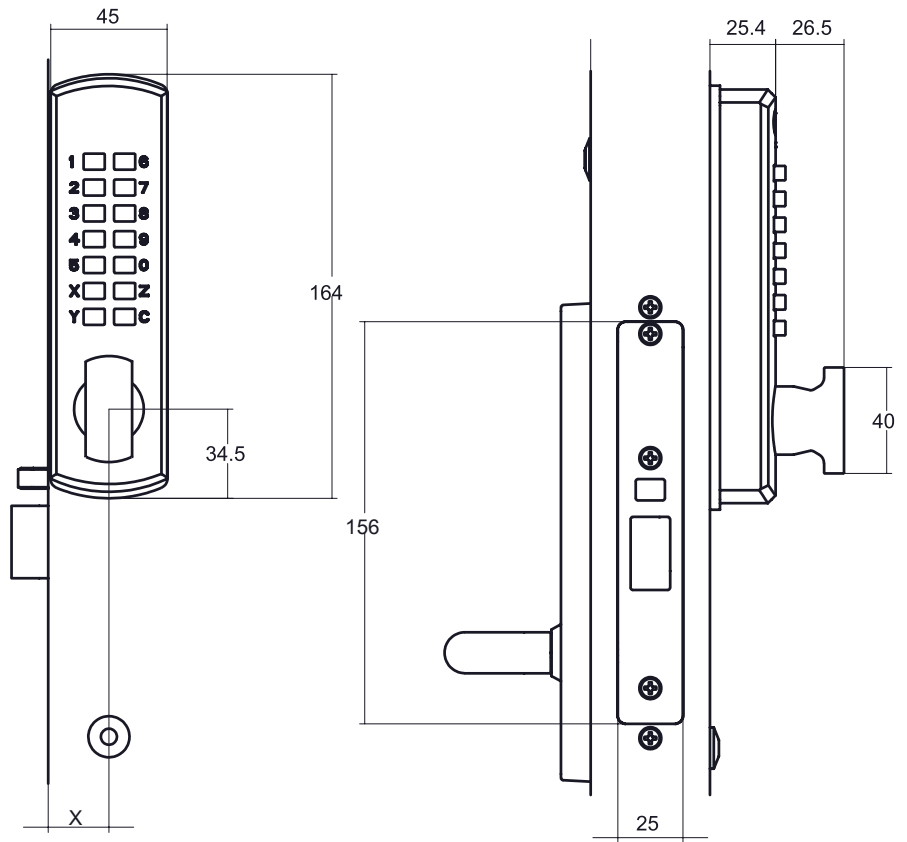

Selector® 3782 Short Backset DX Digital Mortise Locks

Part Number	3782DX	4782DX	5782DX	6782DX
Dimension X	23	25.4	30	38

Note: Order by specifying 3782SS primary lock and 3782-DXKITSC.

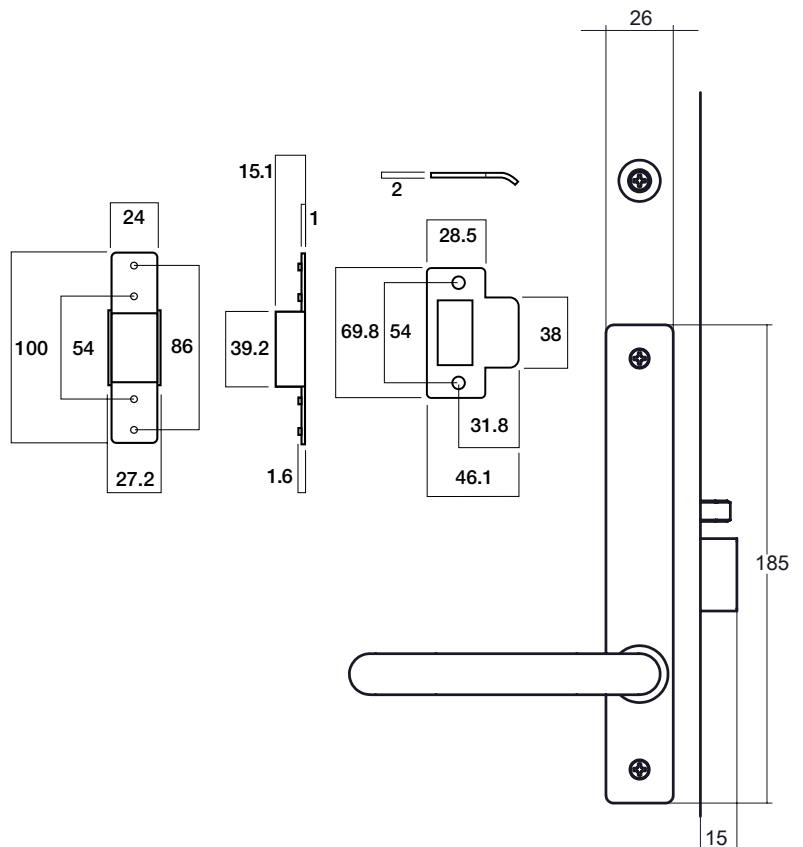

Selector® 3782 Short Backset DX Digital Mortice Locks

DX Digital Mortice Lock

Part Number 3782DX-

DX Digital outside, plate furniture inside.

Outside: Opened by DX Digital with code.

Inside: Opened by handle at all times.

This function requires the locking bar to be positioned in the locked position once lock is set.

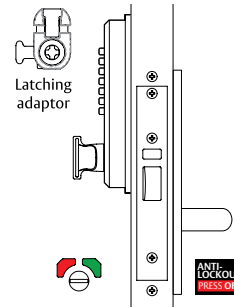

DX Digital Mortice Lock with Holdback by Cylinder#

Part Number 3782DXV

DX Digital outside, plate furniture and cylinder inside.

Outside: Opened by DX Digital with code.

Inside: Opened by handle at all times. Holdback activated by key. Key retracts latch after releasing holdback.

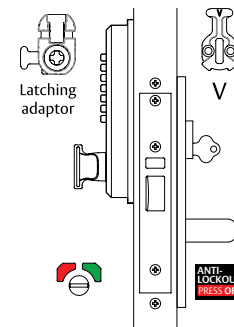

Notes:

All drawings shown are in right hand configuration. Part numbers shown above are for 23mm backset lock, if 25.4mm is required substitute 3 for 4 i.e. 4782, or if 30mm or 38mm lock is required, substitute 3 for 5 or 6 respectively i.e. 5782, 6782

#Latch bolt can be held within the lock. Lock function recommended for use in holdback application.

Warning:

The MkI Latching Adaptor (now part number 3770M1-ADAPTOR) can only be used with the MkI Selector Mortice Locks and the MkII Latching Adaptor (3770M2-ADAPTOR) can only be used with MkII Selector Mortice Locks.

For the 3780 Series short backset mortice locks, the MkI Latching Adaptor 3770M1-ADAPTOR must be used where a latching adaptor is required.

Legend

Hub Setting



Anti-lockout Selection



Cam or Adaptor



Selector® 3782 Short Backset Key Override DX Digital Mortice Locks



Description

Lockwood DX Digital Locksets provide a mechanical method of keyless entry.

For extra security when under forced attack, the inbuilt clutching mechanism allows the outside turnknob to rotate without operating or damaging the lock.

The factory set 4 digit code is easily changed to any 4, 5 or 6 digit code using the code changing kit provided with each lock.

Lockwood Digital DX Locksets are designed to control access into commercial areas.

As the digital lockset utilizes mechanical operation, electrical wiring is not required.

Product Details

Door Thickness	43 to 46mm for metal doors
Finish	Codepad: Satin Chrome Brushed (SC) Mortice Lock: Stainless Steel (SS)
Codepad Assembly	High purity zinc alloy, 45mm wide, 164mm high, 52mm projection
Latch	Stainless steel with 15mm projection

Note: As suitability of lever will be influenced by the lock backset, refer to chart for Lever/Backset compatibility Lockwood Door Handle Catalogue. Lockwood 4800 and 5800 Series (ordered separately).

Backset

Open-out door: 23, 25.4, 30 and 38mm.
Open-in door: 38mm recommended.
Installation of 23, 25.4 or 30mm on open-in doors would require the door stop to be machined to clear the digital pad.

Inside Function

Opened by lever handle at all times.

Holdback Function

Holdback function is available, this requires the inclusion of an internal cylinder.

Selector® 3782 Short Backset Key Override DX Digital Mortise Locks



Exterior

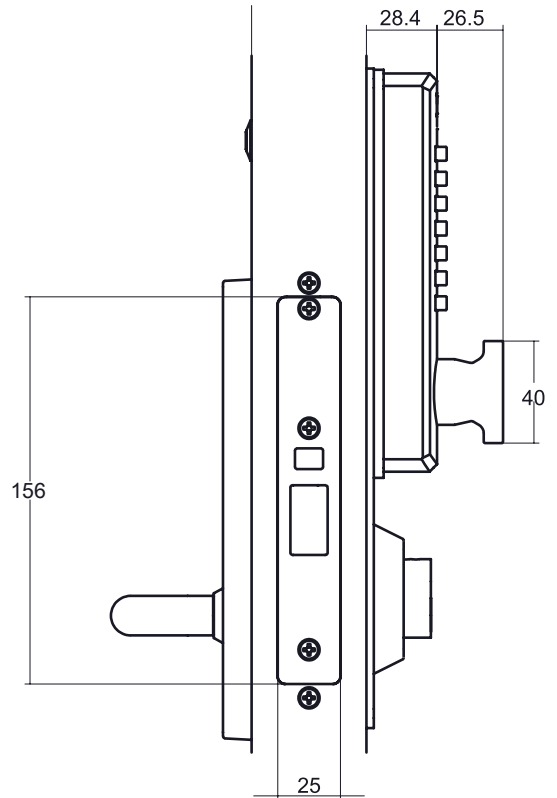
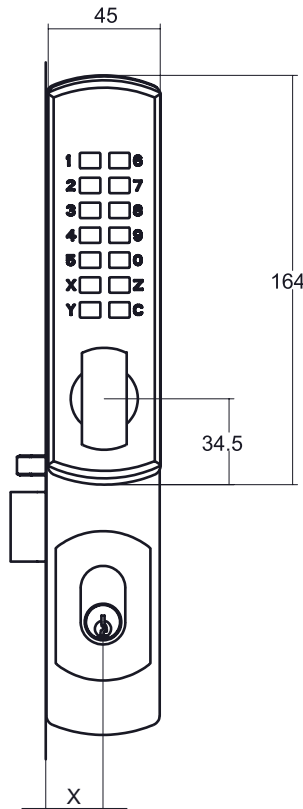

Interior

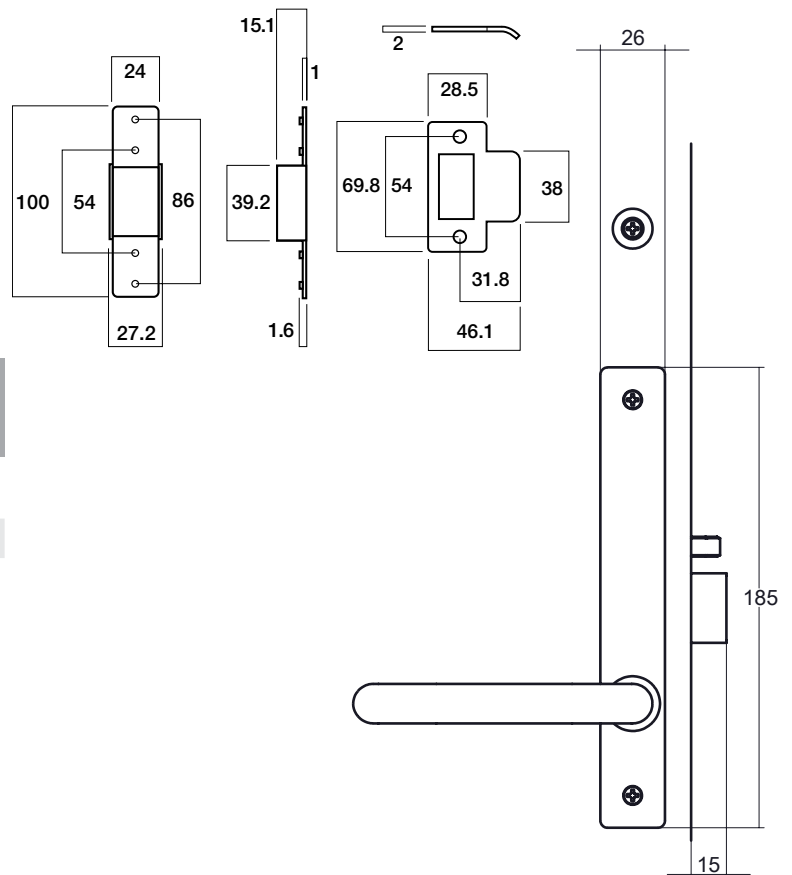

Selector® 3782 Short Backset Key Override DX Digital Mortise Locks

Part Number	3782DXKO	4782DXKO	5782DXKO	6782DXKO
Dimension X	23	25.4	30	38

Note: Order by specifying 3782SS primary lock and 3782-DXKOKITSC. Cylinders must be ordered separately. Key Override DX Digital kit only suits 43-46mm door thickness.

Selector® 3782 Short Backset Key Override DX Digital Mortice Locks

DX Digital Mortice Lock with Key Override

Part Number 3782DXKO-

DX Digital and lower cylinder outside, plate furniture inside.
Outside: Opened by DX Digital with code or key at all times.

Inside: Opened by handle at all times.

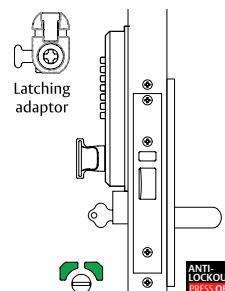

DX Digital Mortice Lock with Key Override and Internal Cylinder#

Part Number 3782DXKOV

DX Digital and lower cylinder outside, plate furniture and cylinder inside.

Outside: Opened by DX Digital with code or key at all times.

Inside: Opened by handle at all times. Holdback activated by key. Key retracts latch after releasing holdback.

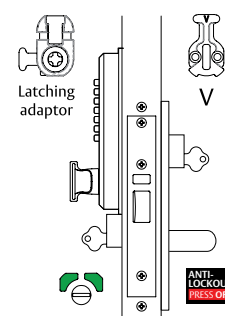

Notes:

All drawings shown are in right hand configuration. Part numbers shown above are for 23mm backset lock, if 25.4mm is required substitute 3 for 4 i.e. 4787, or if 30mm or 38mm lock is required, substitute 3 for 5 or 6 respectively i.e. 5787, 6787

#Latch bolt can be held within the lock. Lock function recommended for use in holdback application.

Warning:

The Mkl Latching Adaptor (now part number 3770M1-ADAPTOR) can only be used with the Mkl Selector Mortice Locks and the MkII Latching Adaptor (3770M2-ADAPTOR) can only be used with MkII Selector Mortice Locks. For the 3780 Series short backset mortice locks, the Mkl Latching Adaptor 3770M1-ADAPTOR must be used where a latching adaptor is required.

Legend

Hub Setting



Anti-lockout Selection



Cam or Adaptor



Selector® 3780 Series Accessories

Alternative Finish Kits

Part Number	Finish
3782-FINKITCP*	Chrome Plate
3782-FINKITPC	Powder Coat

Finish kits include: Strike, faceplate and screws.
 Finish kits are not suitable for use with 25.4mm backset 4782 lock.
 *Screws not included.

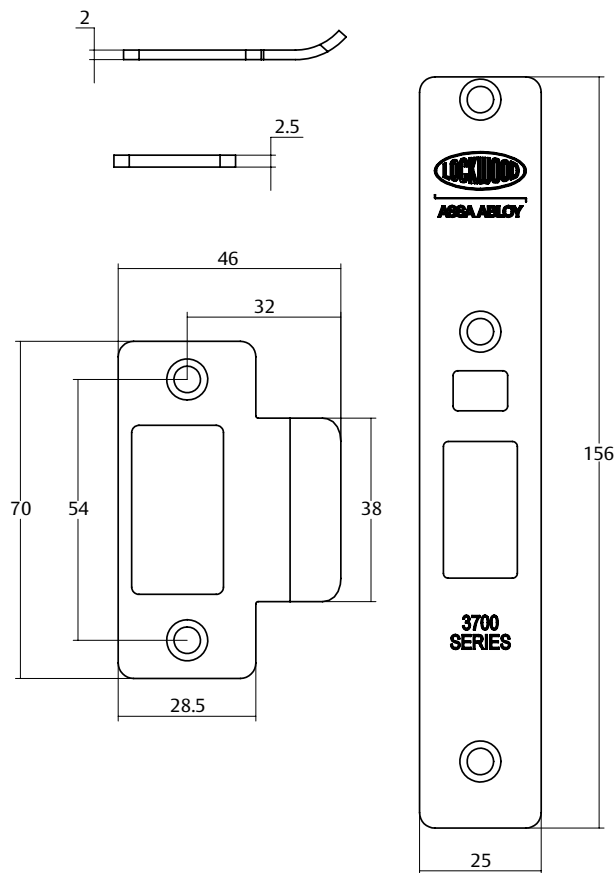

Timber Door Fixing Kit

Part Number	Finish
3782-TFKITSS*	Stainless Steel
3782-TFKITCP*	Chrome Plate
3782-TFKITPB	Polished Brass

Timber door fixing kits are not suitable for use with 25.4mm backset 4782 lock.
 *Faceplate screws not included

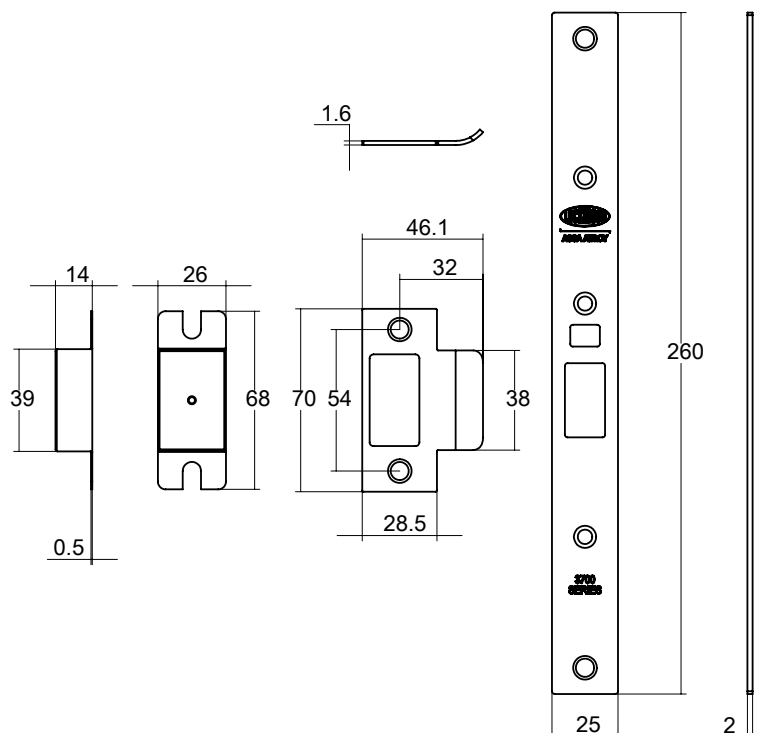

Selector® 3780 Series Accessories

ES2100 Electric Strike Faceplates

Part Number	Application
3782-2100SS	To suit 3780 Series
3782TF-2100SS*	To suit 3780 Series with Timber Door Fixing

To work in conjunction with the Lockwood Padde Series ES2100 electric strike for door position monitoring.

* Can be used directly with a 3782SS primary lock
- No additional TF fixing kit is required.

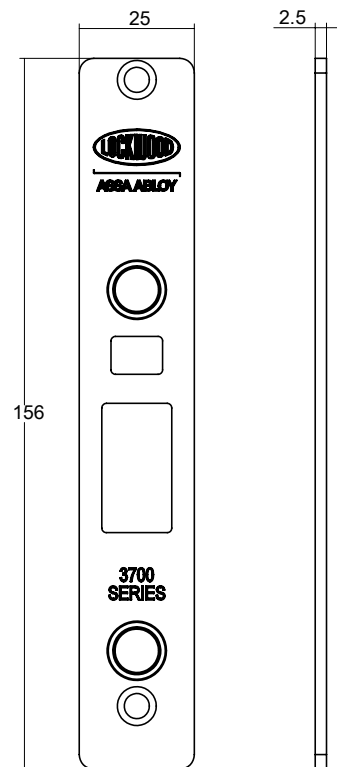

Security Faceplate Screw Kit

Part Number	Application
3782-SECKIT	To suit 3780 Series

Kit contains five replacement faceplate screws with tamper resistant TR20 Torx drive heads.

Selector® 3780 Series Accessories

Short/Extended Lipped Strikes

Part Number	Lip Length A	Strike Length B
3782-STK32XX	32mm	46.1mm
3782-STK74XX*	74mm	88.5mm

To order, add finish code to part number.

XX designates the finish.

SS - Stainless Steel, **CP** - Chrome Plate, **PB** - Polished Brass

*Only available in Stainless Steel (**SS**) finish.

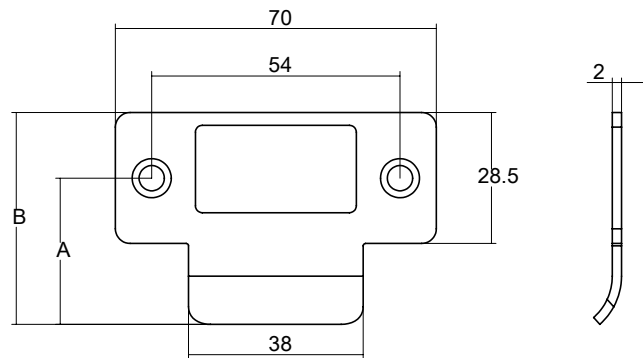

Fabricator Strikes

Part Number	Lip Length A	Strike Length B
3782-FSTK32SS	32mm	47.2mm
3782-FSTK64SS	64mm	80.2mm

Stainless Steel D shaped strike.

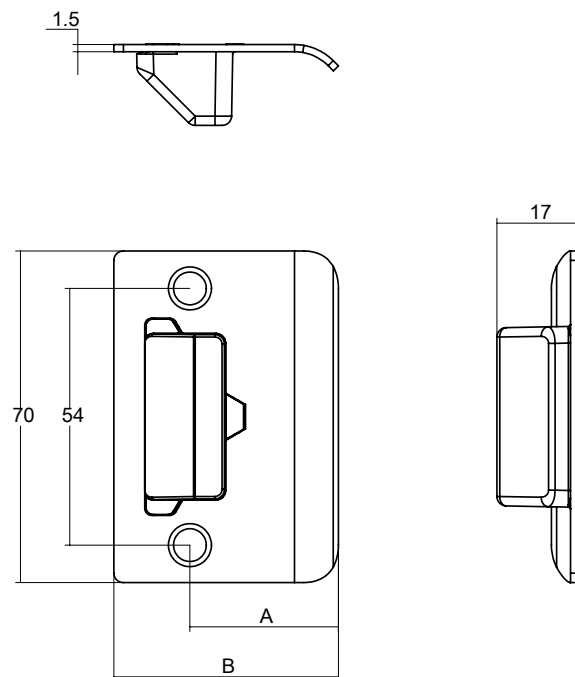

Selector® 3780 Series Accessories

Retrofit Strike Kits

Part Number	Finish
3782-RFSTKCP	Chrome Plate
3782-RFSTKSC	Satin Chrome Brushed

For replacement of existing installations where Lockwood 5900, 595 and Astra Short Backset are used. For replacement of Astra specify 25.4mm backset.

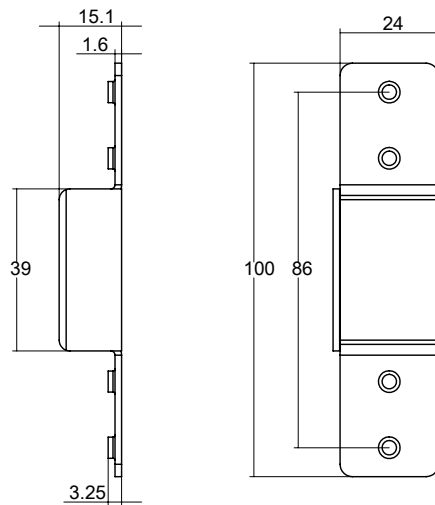
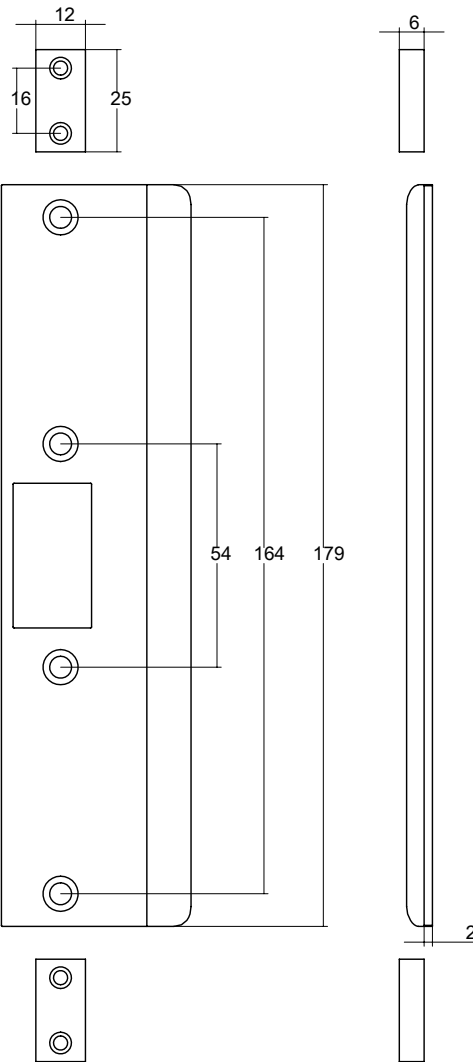

Selector® 3780 Series Accessories

Rebate Kits

Part Number	Finish
5782-RK ##CP	Chrome Plate
5782-RK ##SS	Stainless Steel
5782-RK ##PB	Polished Brass

Rebate kits to suit 13mm rebated timber doors with minimum backset of 30mm.

To order, add door handing to part number.

Refer to door handing guide at the bottom of page.

designates door handing.

CW - Clockwise

ACW - Anti-clockwise

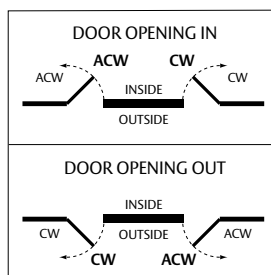
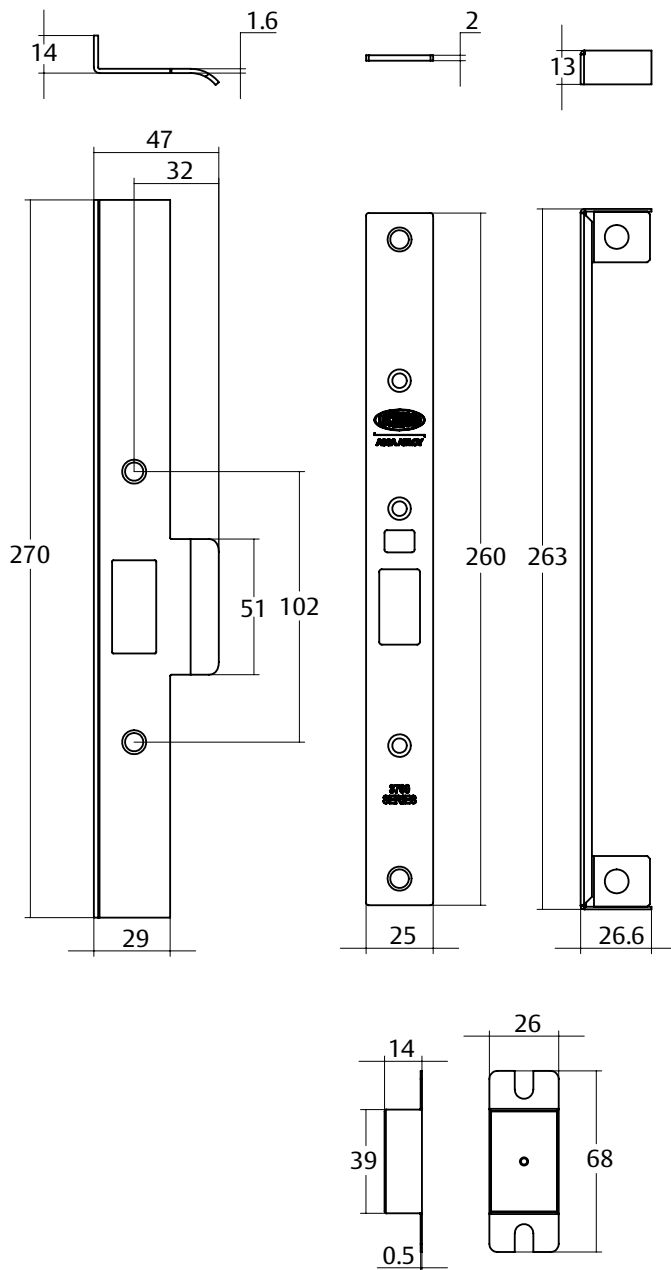

CW Left Hand open in
(Clockwise) Right Hand open out

ACW Left Hand open out
(Anti-Clockwise) Right Hand open in

Selector® 3780 Series Accessories

Mortice Lock Spindles

Part Number	Pack Size	Length "A"	Door Thickness	
			Min	Max
SP3570-5018	10	33mm	32	50
SP3570-5228	1	45mm	50	75
SP3570-5238	1	58mm	75	100
SP3570-5258	1	108mm	100	200

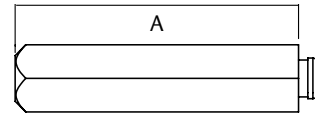
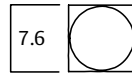

Single Cylinder Assemblies

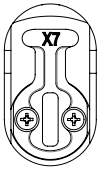

"X7" Cam Cylinder
570C4/X7

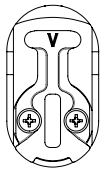

"V" Cam Cylinder
570C4/V



3787 Lower Cylinder
with Spindle Cam
570EC4/87

Cylinder Cams

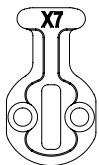

"X7" Cam
SP3700/X7CAM

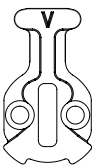

"V" Cam
SP3700/VCAM

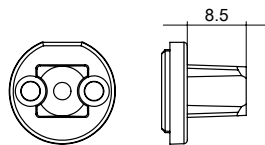

3787 Spindle Cam
SP3787/CAM

Adaptors

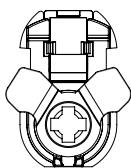

Locking Adaptor
3772-ADAPTOR

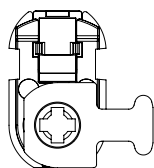

Latching Adaptor
3770M1-ADAPTOR

Selector® 3780 Series Cam and Adaptors Function Chart

Selector® 3780 Series Cam and Adaptors Function Chart

Selector® 3780 Series	Function Description	Primary Lock	Outside Cylinder Cam/Adaptor	Inside Cylinder Cam/Adaptor	Kit
Selector® 3780 Nightlatches					
3780-TSS	Nightlatch with Turn	3780TSS	-	3770M1-ADAPTOR	
3780X-SS	Nightlatch with Cylinder	3782SS	X7	-	
3780XTSS	Nightlatch with Cylinder and Turn	3780TSS	X7	3770M1-ADAPTOR	
3780XXSS	Nightlatch with Double Cylinder	3782SS	X7	X7	
Selector® 3782 Escape Locks					
3782SS	Escape Primary Lock	3782SS	-	-	
3782-SS	Escape Lock	3782SS	-	-	
3782V-SS#	Anti-vandal Escape Lock	3782SS	V	-	
3782VTSS#	Anti-vandal Escape Lock with Turn	3782TSS	V	3772-ADAPTOR	
3782X-SS	Key Entry Escape Lock	3782SS	X7	-	
3782XTSS#	Key Entry Escape Lock with Turn	3782TSS	X7	3772-ADAPTOR	
3782-VSS#	Escape Lock with Internal Cylinder	3782SS	-	V	
3782-TSS#	Escape Lock with Turn	3782TSS	-	3772-ADAPTOR	
3782XVSS#	Key Entry Escape Lock with Internal Cylinder	3782SS	X7	V	
3782-TASS	Anti-lockout Escape Lock with Turn	3782TSS	-	3772-ADAPTOR	
3782VTASS	Anti-lockout Anti-vandal Escape Lock with Turn	3782TSS	V	3772-ADAPTOR	
Selector® 3784 Combination Locks					
3784SS	Passage Latch	3782SS	-	-	
3784VTSS#	Anti-vandal Lock with Turn	3782TSS	V	3772-ADAPTOR	
3784VVSS#	Anti-vandal Lock with Internal Cylinder	3782SS	V	V	
3784XVSS#	Key Entry Lock with Internal Cylinder	3782SS	X7	V	
3784XXSS	Key Entry Double Cylinder Lock	3782SS	X7	X7	
3784-TSS	Combination Lock with Turn	3782TSS	-	3772-ADAPTOR	
3784-TASS	Anti-lockout Combination Lock with Turn	3782TSS	-	3772-ADAPTOR	
3784VTASS	Anti-lockout Anti-vandal Lock with Turn	3782TSS	V	3772-ADAPTOR	
3784VVASS	Anti-lockout Anti-vandal Lock with Internal Cylinder	3782SS	V	V	
Selector® 3787 Dual Entry Locks					
3787X-SS	Dual Entry Lock	3782SS	X7, 3787 SPINDLE CAM	-	3787-KIT570E
3787V-SS	Dual Entry Lock with Lower Cylinder Lockout	3782SS	V, 3787 SPINDLE CAM	-	3787-KIT570E

Selector® 3780 Series Cam and Adaptors Function Chart

Selector® 3780 Series Cam and Adaptors Function Chart

Selector® 3780 Series	Function Description	Primary Lock	Outside Cylinder Cam/Adaptor	Inside Cylinder Cam/Adaptor	Kit
Selector® Privacy Locks					
3782-TSS	Escape Privacy Lock	3782TSS	-	3772-ADAPTOR	
3782-TASS	Anti-lockout Escape Privacy Lock	3782TSS	-	3772-ADAPTOR	
3784-TSS	Privacy Lock	3782TSS	-	3772-ADAPTOR	
3784-TASS	Anti-lockout Privacy Lock	3782TSS	-	3772-ADAPTOR	
3787-TSS	Key Entry Privacy Lock	3782TSS	3787 SPINDLE CAM	3772-ADAPTOR	3787-KIT570E
3787-TASS	Key Entry Anti-lockout Privacy Lock	3782TSS	3787 SPINDLE CAM	3772-ADAPTOR	3787-KIT570E
Selector® 3782 DX Digital Locks					
3782DX-SS	DX Mechanical Digital Mortice Lock	3782SS	3770M1-ADAPTOR	-	3782-DXKITSC
3782DXVSS#	DX Mechanical Digital Mortice Lock with Internal Cylinder	3782SS	3770M1-ADAPTOR	V	3782-DXKITSC
3782DXKO-SS	DX Mechanical Digital Mortice Lock with Key Override	3782SS	3770M1-ADAPTOR	-	3782-DXKOKITSC
3782DXKOVSS#	DX Mechanical Digital Mortice Lock with Key Override and Internal Cylinder	3782SS	3770M1-ADAPTOR	V	3782-DXKOKITSC

Note: Items in Italics are Primary Locks and can be purchased from ASSA ABLOY.

#Lock function suitable for holdback application. Holdback can be activated at any time - unless anti-lockout is selected.

Cylinders sold separately, purchased configurations include adaptors as required.

Only 30mm and 38mm backset locks are suitable in DXs configurations on opening in doors.

Synergy Series Conversion Chart

Synergy Series Conversion Chart

Synergy Series	Selector® 3780 Series	Function Description	Note
Escape Locks			
3582SC	3782SS	Escape Lock	
3582-ASC			3782 series primary lock has anti-lockout functionality. To set anti-lockout function, refer to setting and operating instructions.
3582-T#SC	3782-TSS	Escape Privacy Lock	
3582WA#SC	3782VTASS	Anti-lockout Anti-vandal Escape Lock with Turn	V cam has the functionality of locking lock just as the W cam. V cam also retracts bolt after unlocking lock.
3582WT#SC	3782VTSS	Anti-vandal Escape Lock with Turn	V cam has the functionality of locking lock just as the W cam. V cam also retracts bolt after unlocking lock.
3582X-#SC	3782X-SS	Key Entry Escape Lock	X7 cam has the functionality of retracting bolt and locking lock. Does not have unlocking functionality.
3582XT#SC	3782XTSS	Key Entry Escape Lock with Turn	X7 cam has the functionality of retracting bolt and locking lock. Does not have unlocking functionality.
3582XZ#SC	3782XVSS	Key Entry Escape Lock with Internal Cylinder	V cam has the functionality of locking lock just as the Z cam. V cam also retracts bolt after unlocking lock. X7 cam has the functionality of retracting bolt and locking lock. Does not have unlocking functionality.
3582-Z#SC	3782-VSS	Escape Lock with Internal Cylinder	V cam has the functionality of locking lock just as the Z cam. V cam also retracts bolt after unlocking lock.
3582Z-#SC	3782V-SS	Anti-vandal Escape Lock	V cam has the functionality of locking lock just as the Z cam. V cam also retracts bolt after unlocking lock.
Combination Locks			
3584ET#SC	3784-TSS	Combination Lock with Turn	
3584#SC	3784SS	Passage Latch	
3584-T#SC	3784-TSS	Combination Lock with Turn	
3584WT#SC	3784VTSS	Anti-vandal Lock with Turn	V cam has the functionality of locking lock just as the W cam. V cam also retracts bolt after unlocking lock.
3584XX#SC	3784XXSS	Key Entry Double Cylinder Lock	X7 cam has the functionality of retracting bolt and locking lock. Does not have unlocking functionality.
3584XZ#SC	3784XVSS	Key Entry Lock with Internal Cylinder	V cam has the functionality of locking lock just as the Z cam. V cam also retracts bolt after unlocking lock. X7 cam has the functionality of retracting bolt and locking lock. Does not have unlocking functionality.
3584Z-#SC	3784V-SS	Anti-vandal Lock	V cam has the functionality of locking lock just as the Z cam. V cam also retracts bolt after unlocking lock.
3584ZZ#SC	3784VSS	Anti-vandal Lock with Internal Cylinder	V cam has the functionality of locking lock just as the Z cam. V cam also retracts bolt after unlocking lock.
Timber Fixing			
3592SC			For timber fixing, specify the lock with an additional line 3782-TFKITxx where xx designates the required finish.

Synergy Series Conversion Chart

Synergy Series Conversion Chart

Synergy Series	Selector® 3780 Series	Function Description	Note
Extended Lip Strikes			
SP3580-53SC	3782-STK32SS	3782 STANDARD STRIKE 32MM LIP PK=10	
SP3580-53CP	3782-STK32CP	3782 STANDARD STRIKE 32MM LIP PK=10	
SP3580-53PB	3782-STK32PB	3782 STANDARD STRIKE 32MM LIP PK=10	
SP3580-A53SC	3782-STK74SS	3782 LONG LIP STRIKE 74MM LIP	
SP3580-52	3782-STKBOX	3782 STRIKE BOX PK=10	
Surface Mounted Fabricator Lip Strikes			
SP3P80-053SS	3782-FSTK32SS	3782 FABRICATOR STRIKE KIT 32MM LIP	
SP3P80-153SS	3782-FSTK64SS	3782 FABRICATOR STRIKE KIT 64MM LIP	
Retrofit Strikes			
3580-1902SC	3782-RFSTKSC	3782 RETROFIT STRIKE KIT	
3580-1902CP	3782-RFSTKCP	3782 RETROFIT STRIKE KIT	
3580-1902PB	3782-RFSTKPB	3782 RETROFIT STRIKE KIT	
Rebate Kits			
3580-2902ACWSC	5782-RKACWSS	5782/6782 REBATE KIT ANTICLOCKWISE	
3580-2902ACWCP	5782-RKACWCP	5782/6782 REBATE KIT ANTICLOCKWISE	
3580-2902ACWPB	5782-RKACWPB	5782/6782 REBATE KIT ANTICLOCKWISE	
3580-2902CWSC	5782-RKCWSS	5782/6782 REBATE KIT CLOCKWISE	
3580-2902CWCP	5782-RKCWCP	5782/6782 REBATE KIT CLOCKWISE	
3580-2902CWPB	5782-RKCWPB	5782/6782 REBATE KIT CLOCKWISE	

Selector® 3780 Series Short Backset Mortice Locks Functioning Matrix

Functioning Matrix

Sample part number 3782VTASS is made up of seven elements.
The description of this part number is an Anti-lockout Anti-vandal escape lock with cylinder and turn in satin stainless steel finish. Choose your product by selecting an option from each element.

Backset	Series	Platform	Function	Sub Function	Anit-lockout Selection	Finish
3	7	8	2	VT	A	SS

Backset

23mm	3
25.4mm	4
30mm	5
38mm	6

Series

Selector® Series Mortice Locks	7
--------------------------------	---

Platform

Short Backset	8
---------------	---

Functions

Nightlatch	0
Escape Lock	2
Combination Lock	4
Dual Entry Lock	7

Sub Function

e.g. Outside	Inside
V	T
Locking and Latching Cylinder with V Cam	V
Latching Cylinder with X7 Cam	X
Turnbutton Adaptor	T
No Sub Function	-
DX Digital	DX
DX Digital with Key Override	DXKO

Anit-lockout Selection

Neutral	
Anti-lockout	A

Finish

Stainless Steel	SS
-----------------	----

Code

1. Backset: Nominate backset as required, for example 3 = 23mm backset.

2. Function: Select function, for example 782 = Escape Lock

3. Sub Function: Determine sub function requirements for both exterior and interior.
For example:
Exterior – Locking function required – specify V (cylinder).
Interior – Turnknob function required – specify T (turnbutton adaptor).

4. Anti-lockout Selection: Determine if anti-lockout function is needed.
For example:
Anti-lockout - Specify A

5. Finish: Select appropriate finish, e.g. SS
Other finishes available by specifying finish kits.

**We take the worry out of
protecting what's valuable to you.**
Lockwood: *no worries*[®]





ASSA ABLOY

Lockwood is the leading brand in the Australian locking industry. With an established reputation for high quality products, this iconic brand provides a wide range of locking solutions to residential housing, commercial, semi-commercial, building and industrial application markets. Lockwood is supported by an extensive distribution and after-sales support network. Our customers include retailers, architects, trade and industrial personnel, locksmiths and security dealers.

ASSA ABLOY is the global leader in door opening solutions, dedicated to satisfying end-user needs for security, safety and convenience.

ASSA ABLOY is represented in all major regions, in both mature and emerging markets, with leading positions in Australia, Europe and North America.

**25YEAR
MECHANICAL
WARRANTY**

The Lockwood 25 Year Mechanical Warranty

Our belief that we manufacture the finest premium products available in today's market place is backed by the Lockwood 25 Year Mechanical Warranty, ensuring that Lockwood continues to keep Australians safe by delivering security and peace of mind.

For warranty terms and conditions, please visit www.lockweb.com.au or call **1300WARRANTY**

ASSA ABLOY Australia Pty Ltd
235 Huntingdale Road
Oakleigh, Victoria, 3166
Australia

1300 LOCK UP (1300 562 587)
lockweb.com.au

ASSA ABLOY New Zealand Ltd
6 Armstrong Road
Albany, Auckland, 0632
New Zealand

info.nz@assaabloy.com
Telephone +64 9415 7111
assaabloy.co.nz

Disclaimer

Whilst every effort has been made to ensure that the information (including product images and drawings) contained in this brochure is accurate at the time of publication, ASSA ABLOY Australia Pty Limited ("ASSA ABLOY") recommends that you consult ASSA ABLOY or its agents prior to placing an order to ascertain current information on specific products, as ASSA ABLOY reserves the right to make changes without notice. ASSA ABLOY will not be liable for any injury, loss or damage whatsoever, arising from any errors or omissions in the information contained in the brochure or arising from the use or application of the information contained herein. © 2016 copyright by ASSA ABLOY All rights reserved

