

# Rimlocks



 **accesshardware**

BUSINESS  
REWARDS 

We take the worry out of  
protecting what's valuable to you.  
**Lockwood: no worries<sup>®</sup>**

**LOCKWOOD**

**ASSA ABLOY**

**25YEAR** MECHANICAL  
WARRANTY

[www.lockweb.com.au](http://www.lockweb.com.au)

# Contents



**001 Double**  
Cylinder Deadlatch  
page 3



**002 Single**  
Cylinder Deadlatch  
page 8



**355 Double**  
Cylinder Deadlock  
page 15



**303 Single**  
Cylinder Deadlock  
page 17



**507**  
Fire Rated Nightlatch  
page 20



**201**  
Nightlatch  
page 22



**100**  
Nightlatch  
page 24



**211**  
Nightlatch  
page 26



**200**  
Narrow Stile Streamlatch  
page 28



**213**  
Streamlock Deadbolt  
page 30

# 001 Double Cylinder Deadlatch



The Australian-designed Lockwood 001® Deadlatch offers market-leading performance and reliability for your home and is available in both Knob and Lever versions.

The 001® Deadlatch features a cut-resistant stainless steel bolt, 11 concealed anchorage points and a door frame strengthener that combine to offer high security protection.

Additional features include a bolt holdback function that allows you to use your door in passage mode.

## Features and Specifications

- Bolt holdback function activated by external key or internal knob
- Can be key locked in holdback position by key from inside
- Can be keyed alike to other Lockwood door locks
- Available in trade and display pack versions

## Keying

- Supplied individually keyed with two keys per lock
- 78,000 key combinations
- Key blank KB2015P

## Restricted Special Keying

Lockwood locks can be keyed to a number of controlled and/or specially keyed systems. These range from legally protected keys to protect against unauthorised duplication, which can also include specially designed key systems such as master key systems, which allow for different levels of mechanical access control.

Please refer to Lockwood Keying Catalogue or contact your local sales office or customer service for specific information.

## Retrofitable

Replace your existing 001 Deadlatch.

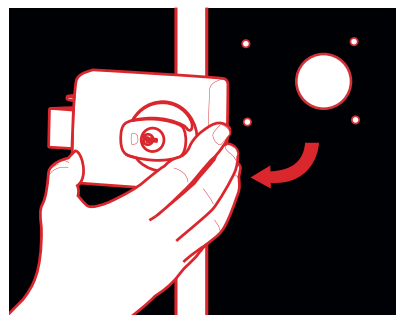

## Product Details

<b>Backset</b>	60mm
<b>Case</b>	High purity zinc alloy
<b>Cylinders</b>	Internal and external 5 pin tumbler mechanism. Brass cylinders and brass barrels.
<b>Door Thickness</b>	30 - 45mm
<b>Finish*</b>	Satin Chrome Pearl (SP) Chrome Plate (CP) Brown (BRN) Everbrass (EVB)
<b>Latch</b>	Stainless steel 18mm projection
<b>Packers</b>	3mm thick packer plates are available, these packers are installed under lock body to align lock body with face of jamb

\*Refer to pages 5 and 7 for product range

## Standards and Compliance

Conforms to Australian Standard (AS4145.2-2008 S<sub>7</sub>D8C6)

# 001 Double Cylinder Deadlatch

## Double Cylinder with Knob

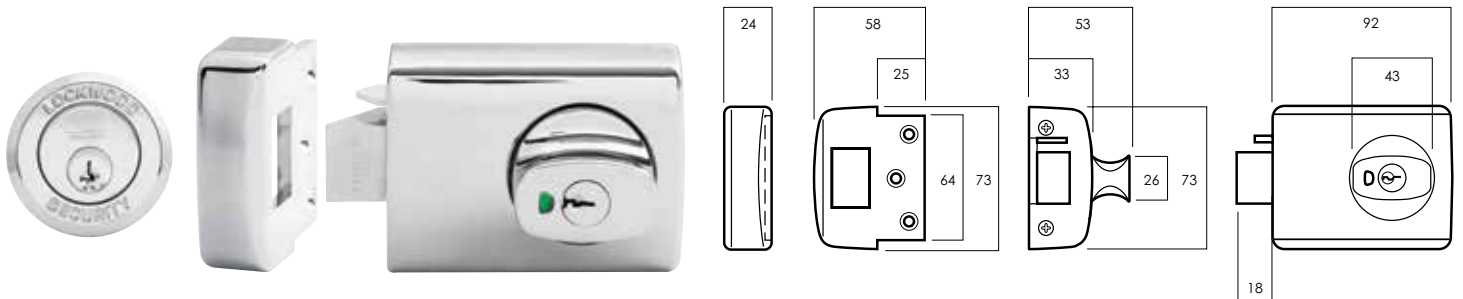

Exterior Cylinder

Interior



**Kinetic Defence®**  
Bump and pick resistant.



**2 Keys Included**  
Can be keyed alike to other  
Lockwood door locks.



**SafetyRelease™**  
Minimises the risk of being  
locked in.



**Retrofitable**  
Replace your existing  
001 Deadlatch.



**LockAlert®**  
Interior Indicator shows lock  
status at a glance.



**Safety Mode**  
Securely locked from outside  
and free from inside.



**Secure Mode**  
Securely locked from both  
inside and outside. For when  
nobody is home.



**Passage Mode**  
Free to enter from outside  
and free to exit from inside.



**Deadlatch Bolt**  
Stainless steel 18mm projection.

# 001 Double Cylinder Deadlatch

## 001 - Knob with Open In Strike - Single Pack

Finish	Trade Pack	Display Pack
Satin Chrome Pearl	001-1K1SP	001-1K1SPDP
Chrome Plate	001-1K1CP	001-1K1CPDP
Brown	—	001-1K1BRNDP
Everbrass	001-1K1EVB	—

Suitable for INWARD opening timber framed doors.

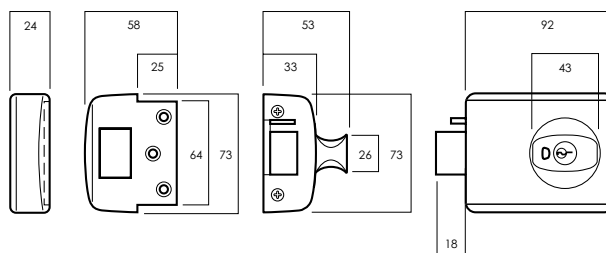

## 001 - Knob with Open In Strike - Twin Pack

Finish	Trade Pack	Display Pack
Satin Chrome Pearl	001-1K2SP	001-1K2SPDP
Everbrass	—	001-1K2EVBDP

Suitable for INWARD opening timber framed doors. Keyed alike for extra convenience. Pack contains two locksets.

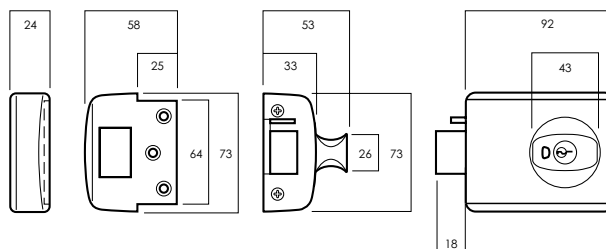

## 001 - Knob with Metal Frame Strike - Single Pack

Finish	Trade Pack
Satin Chrome Pearl	001-3K1SP

Suitable for INWARD opening metal framed doors.

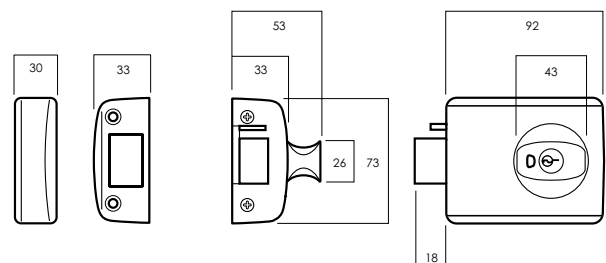

## 001 - Knob with Open Out Strike - Single Pack

Finish	Trade Pack
Satin Chrome Pearl	001-4K1SP

Suitable for OUTWARD opening timber framed doors.

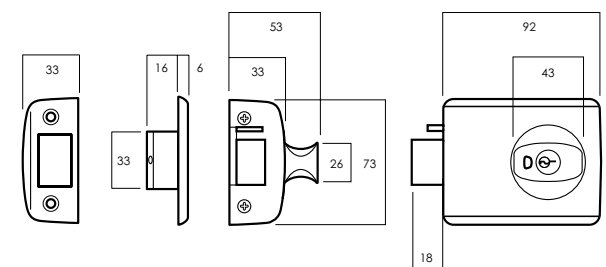

# 001 Double Cylinder Deadlatch

## Double Cylinder with Lever

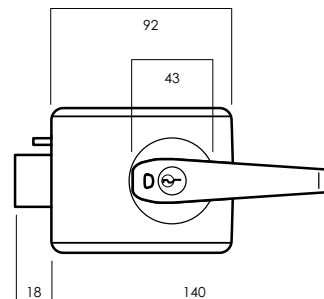

Exterior Cylinder

Interior



**Kinetic Defence®**  
Bump and pick resistant.



**2 Keys Included**  
Can be keyed alike to other  
Lockwood door locks.



**SafetyRelease™**  
Minimises the risk of being  
locked in.



**Retrofitable**  
Replace your existing  
001 Deadlatch.



**LockAlert®**  
Interior Indicator shows lock  
status at a glance.



**Safety Mode**  
Securely locked from outside  
and free from inside.



**Secure Mode**  
Securely locked from both  
inside and outside. For when  
nobody is home.



**Passage Mode**  
Free to enter from outside  
and free to exit from inside.



**Deadlatch Bolt**  
Stainless steel 18mm projection.

# 001 Double Cylinder Deadlatch

## 001 - Lever with Open In Strike - Single Pack

Finish	Trade Pack	Display Pack
Satin Chrome Pearl	001-1L1SP	001-1L1SPDP
Chrome Plate	—	001-1L1CPDP

Suitable for INWARD opening timber framed doors.

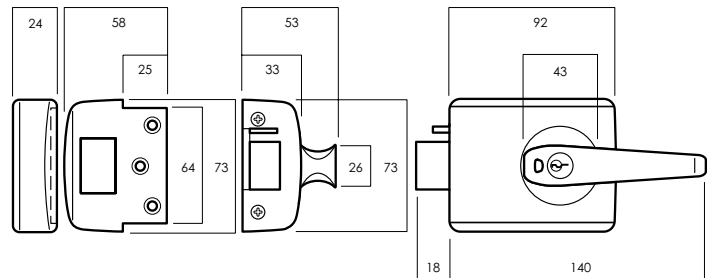

# 002 Single Cylinder Deadlatch



The Australian-designed Lockwood 002 Deadlatch offers market-leading performance and reliability for your home and is available in both Knob and Lever versions.

The 002 Deadlatch features a cut-resistant stainless steel bolt, 11 concealed anchorage points and a door frame strengthener that combine to offer high security protection.

Additional features include a bolt holdback function that allows you to use your door in passage mode.

## Features and Specifications

- High security with cut resistant stainless steel bolt, 11 concealed anchorage points and door frame strengthener
- Bolt holdback function activated by external key or internal knob
- Can be keyed alike to other Lockwood door locks

## Keying

- Supplied individually keyed with two keys per lock
- 78,000 key combinations
- Key blank KB2015P

## Restricted Special Keying

Lockwood locks can be keyed to a number of controlled and/or specially keyed systems. These range from legally protected keys to protect against unauthorised duplication, which can also include specially designed key systems such as master key systems, which allow for different levels of mechanical access control.

Please refer to Lockwood Keying Catalogue or contact your local sales office or customer service for specific information.

## Retrofitable

Replace your existing 001 Deadlatch.

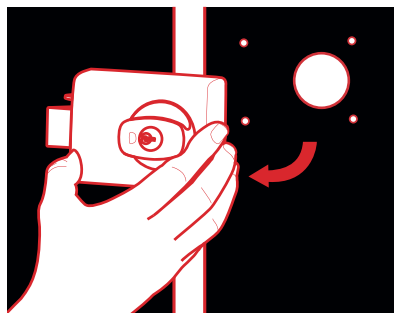

## Product Details

<b>Backset</b>	60mm
<b>Case</b>	High purity zinc alloy
<b>Cylinder</b>	External 5 pin tumbler mechanism. Brass cylinder and brass barrel.
<b>Door Thickness</b>	30 - 45mm
<b>Finish</b>	Satin Chrome Pearl (SP)
<b>Latch</b>	Stainless steel 18mm projection
<b>Packers</b>	3mm thick packer plates are available, these packers are installed under lock body to align lock body with face of jamb

## Standards and Compliance

Conforms to Australian Standard (AS4145.2 - 1993)



# 002 Single Cylinder Deadlatch

## Single Cylinder with Knob

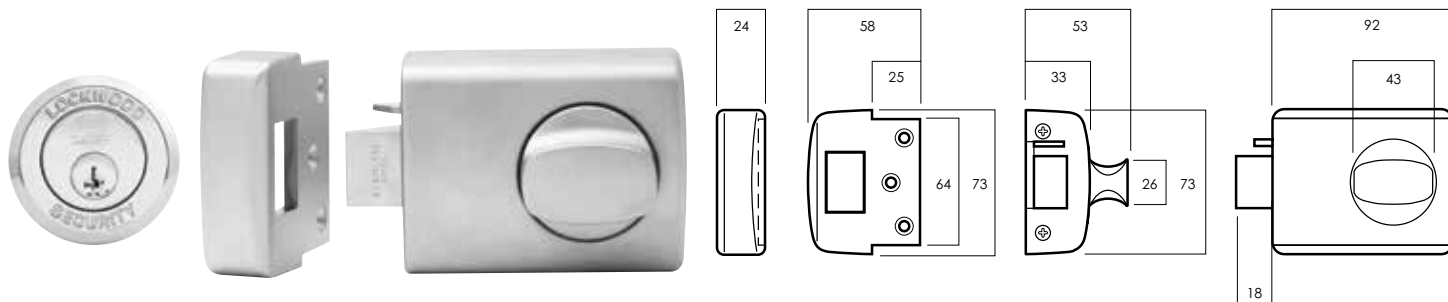

Exterior Cylinder

Interior



**Kinetic Defence®**  
Bump and pick resistant.



**SafetyRelease™**  
Minimises the risk of being locked in.



**2 Keys Included**  
Can be keyed alike to other Lockwood door locks.



**Retrofiable**  
Replace your existing 001 Deadlatch.



**Deadlatch Bolt**  
Stainless steel 18mm projection.

# 002 Single Cylinder Deadlatch

## 002 - Knob with Open In Strike - Single Pack

**Finish**                      **Trade Pack**

Satin Chrome Pearl      002-1K1SP

**No Cylinder**

Satin Chrome Pearl      002-1K1SPNC

Suitable for INWARD opening timber framed doors.

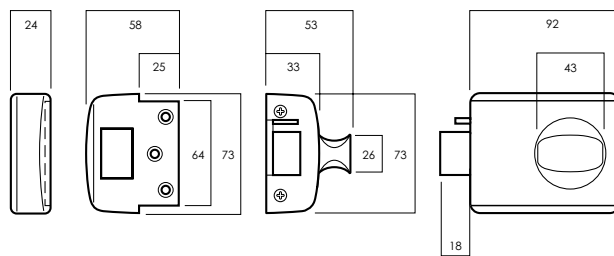

## 002 - Knob with Metal Frame Strike - Single Pack

**Finish**                      **Trade Pack**

Satin Chrome Pearl      002-3K1SP

Suitable for INWARD opening metal framed doors.

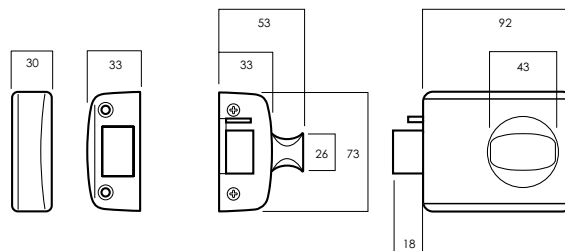

## 002 - Knob with Open Out Strike - Single Pack

**Finish**                      **Trade Pack**

Satin Chrome Pearl      002-4K1SP

Suitable for OUTWARD opening timber framed doors.

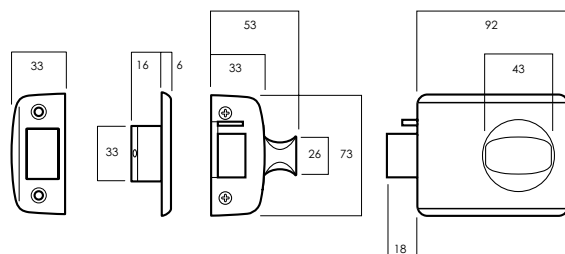

# 002 Single Cylinder Deadlatch

## Single Cylinder with Lever

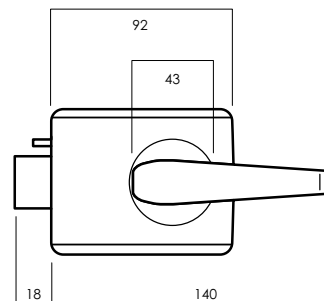
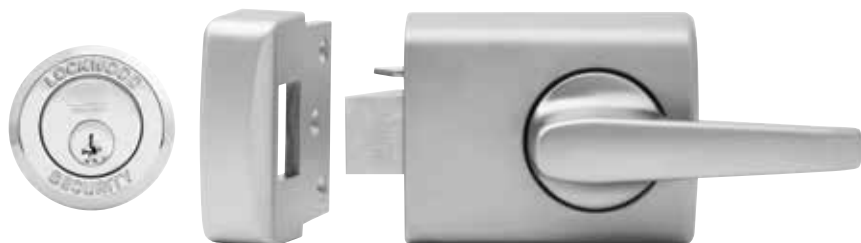

Exterior Cylinder

Interior



**Kinetic Defence®**  
Bump and pick resistant.



**SafetyRelease™**  
Minimises the risk of being locked in.



**2 Keys Included**  
Can be keyed alike to other Lockwood door locks.



**Retrofitable**  
Replace your existing 001 Deadlatch™.



**Deadlatch Bolt**  
Stainless steel 18mm projection.

# 002 Single Cylinder Deadlatch

## 002 - Lever with Open In Strike - Single Pack

**Finish**                      **Trade Pack**

Satin Chrome Pearl      002-1L1SP

**No Cylinder**

Satin Chrome Pearl      002-1L1SPNC

Suitable for INWARD opening timber framed doors.

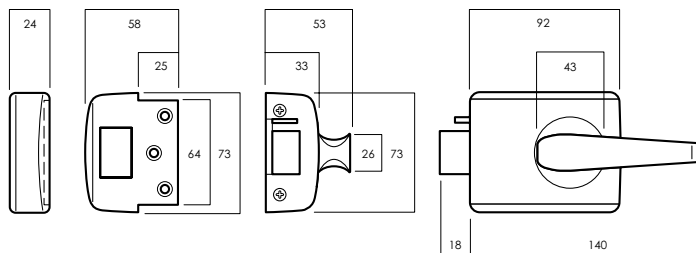

## 002 - Lever with Metal Frame Strike - Single Pack

**Finish**                      **Trade Pack**

Satin Chrome Pearl      002-3L1SP

Suitable for INWARD opening metal framed doors.

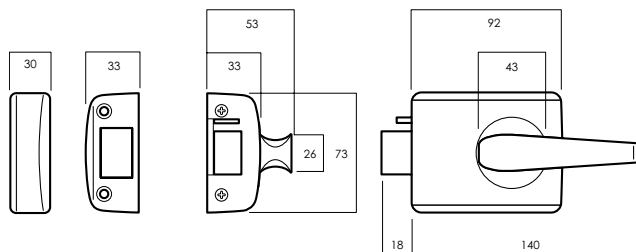

## 002 - Lever with Open Out Strike - Single Pack

**Finish**                      **Trade Pack**

Satin Chrome Pearl      002-4L1SP

**No Cylinder**

Satin Chrome Pearl      002-4L1SPNC

Suitable for OUTWARD opening timber framed doors.

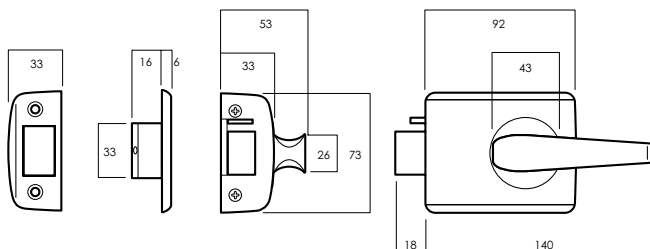

# 001 and 002 Deadlatch - Accessories

## Packer Plate

Finish	Trade Pack
Black	001-3254BLK

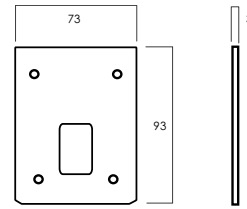

## Retrofit 31mm Strike

Finish	Trade Pack
Satin Chrome Pearl	001-3653SP

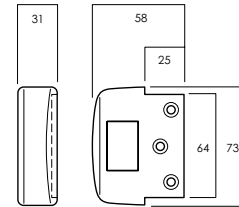

## Metal Frame Strike Pack

Finish	Trade Pack
Satin Chrome Pearl	001-3053SP
Chrome Plate	001-3053CP

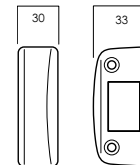

## Outward Opening Strike

Finish	Trade Pack
Satin Chrome Pearl	001-3253SP

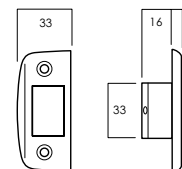

# 001 Double Cylinder Deadlatch

Open Out Bolt

Finish	Trade Pack
--------	------------

Stainless Steel	001-3108
-----------------	----------

\* Pack of 5

# 355 Double Cylinder Deadlock



The premium security features provided by the 355 Deadlock make it an ideal lockset for both domestic and commercial applications.

Opened by key from outside and by turn knob from inside when free. Internal key locks or unlocks turn knob.

## Features and Specifications

- Suitable for hinged and some sliding doors
- Lockable turn knob with inbuilt clutching device to resist wrench attack
- Strong interlocking case and mounting plate to resist jemmy and hammer attack
- Concealed fixing
- Positive deadlocking action
- The mechanism and the design are protected by Australian and International Patents and Design Registrations

## Keying

- Supplied individually keyed with two keys per lock
- 78,000 key combinations
- Key blank KB2015P

## Restricted Special Keying

Lockwood locks can be keyed to a number of controlled and/or specially keyed systems. These range from legally protected keys to protect against unauthorised duplication, which can also include specially designed key systems such as master key systems, which allow for different levels of mechanical access control.

Please refer to Lockwood Keying Catalogue or contact your local sales office or customer service for specific information.

## Product Details

<b>Backset</b>	60mm
<b>Bolt</b>	Stainless steel
<b>Case</b>	Thick walled, high purity zinc alloy casting
<b>Case Retainer Plate and Operating Mechanism</b>	Solid pressed steel and diecast. Zinc components.
<b>Cylinders</b>	Internal and external 5 pin tumbler mechanism. Brass cylinders and brass barrels.
<b>Door Thickness</b>	30 - 45mm
<b>Finish*</b>	Everbrass (EVB) Satin Chrome Pearl (SP) Chrome Plate (CP) Brown (BRN)
<b>Mounting Plate and Strike</b>	Pressed steel
<b>Packers</b>	3mm thick packing plates installed under lock body to align lock body with face of jamb
<b>Strike Conversion Plate</b>	A strike conversion plate is required where the strike is to be installed in place of an existing flange strike

\*Refer to next page for product range

## Standards and Compliance

Conforms to Australian Standard (AS4145.2 - 2008 | S<sub>1</sub>7D8C6)

# 355 Double Cylinder Deadlock

## Double Cylinder with Knob

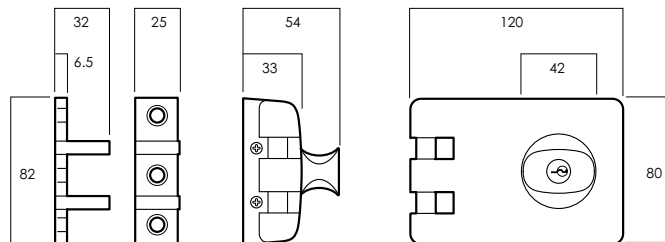

Exterior Cylinder

Interior



**Kinetic Defence®**  
Bump and pick resistant.



**2 Keys Included**  
Can be keyed alike to other  
Lockwood door locks.



**Retrofittable**  
Replace your existing  
001 Deadlatch.

### 355 Double Cylinder Deadlock

Finish	Trade Pack	Display Pack
Everbrass	—	355-NEVBDP
Satin Chrome Pearl	355-NSP	355-NSPDP
Chrome Plate	—	355-NCPDP
Brown	—	355-NBRNDP



# 303 Single Cylinder Deadlock



The security features provided by the 303 Single Cylinder Deadlock make it an ideal lockset for both domestic and commercial applications.

Opened by key from outside and by turn knob from inside.

## Features and Specifications

- Suitable for hinged and some sliding doors
- Lockable turn knob with inbuilt clutching device to resist wrench attack
- Strong interlocking case and mounting plate to resist jemmy and hammer attack
- Concealed fixing
- Positive deadlocking action
- The mechanism and the design are protected by Australian and International Patents and Design Registrations

## Keying

- Supplied individually keyed with two keys per lock
- 78,000 key combinations
- Key blank KB2015P

## Restricted Special Keying

Lockwood locks can be keyed to a number of controlled and/or specially keyed systems. These range from legally protected keys to protect against unauthorised duplication, which can also include specially designed key systems such as master key systems, which allow for different levels of mechanical access control.

Please refer to Lockwood Keying Catalogue or contact your local sales office or customer service for specific information.

## Product Details

<b>Backset</b>	60mm
<b>Bolt</b>	Stainless steel
<b>Case</b>	Thick walled, high purity zinc alloy casting. 121mm wide, 76mm high, 56 projection
<b>Case Retainer Plate and Operating Mechanism</b>	Solid pressed steel and diecast. Zinc components.
<b>Cylinder</b>	External 5 pin tumbler mechanism. Brass cylinder and brass barrel.
<b>Door Thickness</b>	30 - 45mm
<b>Finish</b>	Satin Chrome Pearl (SP)
<b>Packers</b>	3mm thick packing plates installed under lock body to align lock body with face of jamb
<b>Strike Conversion Plate</b>	A strike conversion plate is required where the strike is to be installed in place of an existing flange strike
<b>Mounting Plate and Strike</b>	Pressed steel

## Standards and Compliance

Conforms to Australian Standard (AS4145.2-1993)

# 303 Single Cylinder Deadlock

## Single Cylinder with Knob

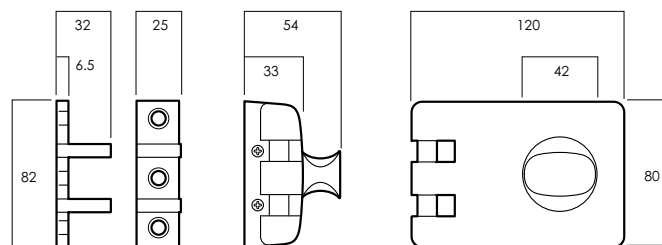

Exterior Cylinder

Interior



**Kinetic Defence®**  
Bump and pick resistant.



**2 Keys Included**  
Can be keyed alike to other  
Lockwood door locks.



**Retrofittable**  
Replace your existing  
001 Deadlatch™.

## 303 Double Cylinder Deadlock

Finish	Trade Pack	Display Pack
Satin Chrome Pearl	303-NSP	303-NSPDP
Satin Chrome Pearl	303-NSPNOCYL	

# 355 and 303 Deadlock - Accessories

## Retrofit Flanged Strike Cover

Finish	Trade Pack
Satin Chrome Pearl	355-552SP

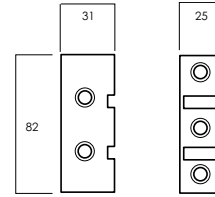

## Strike Loops

Finish	Trade Pack
Satin Chrome Pearl	355-53NSP

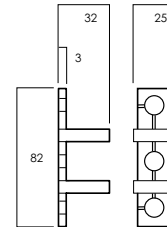

# 507 Fire Rated Night Latch



The 507 Nightlatch is a high quality, fire rated stainless steel nightlatch, making it suitable for a range of commercial applications including utility and service cupboards.

## Features and Specifications

- Easy to operate with a lever turn to retract the latch or key from outside (not supplied)
- 304 stainless steel latch bolt, lock case and striker plates
- Supplied with striker plates to suit standard open in and open out door installations
- Lock handing can be easily changed in seconds by releasing the handing catch and twisting the bolt
- High quality brushed stainless steel finish with welded joints on lock case and striker
- Supplied in trade pack only

## Keying

- Suitable for use with building master key systems
- Standard Lockwood 201 cylinders available for installations not requiring restricted keying

**Note:** Cylinder sold separately

## Product Details

<b>Backset</b>	60mm
<b>Case</b>	304 Stainless Steel
<b>Cylinder (sold separately)</b>	Lockwood 201 Cylinder 5 pin tumbler mechanism
<b>Door Thickness</b>	5 Pin 201 Cylinder - 32mm to 40mm 6 Pin 201 Cylinder - 32mm to 45mm For thicker doors up to 72mm use SP201-338ZP Tail Bar and SP930 - 308ZP
<b>Keying</b>	Supplied less cylinder
<b>Latch &amp; Striker Plates</b>	304 Stainless Steel
<b>Finish</b>	Stainless Steel (SS)

## Standards and Compliance



The Lockwood 507 Rim Nightlatch has been fire rated up to 4 hours on fire door assemblies in accordance with Australian standard (AS 1905.1:2005), Part 1: Fire Resistant Doorsets

**C6** Corrosion Resistance - Tested to 168 Hours - Normal Resistance

**D8** Durability - Tested to 500,000 Cycles

# 507 Fire Rated Night Latch

507



Interior

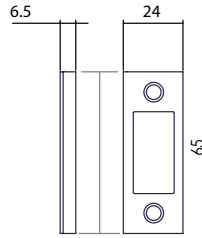

Open Out Strike

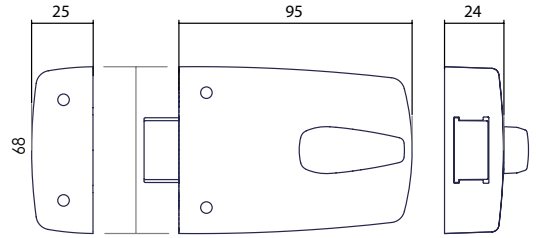

Box Strike

## 507 Fire Rated Nightlatch

Finish	Trade Pack	Cylinder
Brushed Stainless Steel	507SSS	Cylinder not included with open out and open in strike
Satin Chrome	201CYLSC	Lockwood standard cylinder

# 201 Nightlatch



General purpose nightlatch with inside snib.

## Features and Specifications

- Opened by key from outside and by turn knob inside
- Inside snib may be used to holdback or deadlock bolt, so that key will not operate

## Open Out Strike

Part Number SP201-67SC.

## Keying

- Supplied individually keyed with two keys per lock
- 78,000 key combinations
- Key blank KB2015P

## Restricted Special Keying

Lockwood locks can be keyed to a number of controlled and/or specially keyed systems. These range from legally protected keys to protect against unauthorised duplication, which can also include specially designed key systems such as master key systems, which allow for different levels of mechanical access control.

Please refer to Lockwood Keying Catalogue or contact your local sales office or customer service for specific information.

## Product Details

<b>Backset</b>	60mm
<b>Case</b>	High purity zinc alloy. 92mm wide, 64mm high, 43mm projection
<b>Cylinder</b>	5 pin tumbler mechanism Brass cylinder and brass barrel
<b>Door Thickness</b>	28 – 45mm
<b>Latch</b>	Brass. Reversible. 13mm projection
<b>Finish</b>	Lock Body : Brown (BRN) External Cylinder: Satin Chrome (SC) Chrome Plate (CP) Florentine Bronze (FB)

# 201 Nightlatch

201



Exterior Cylinder

Interior

## 201 Nightlatch

Finish	Trade Pack	Display Pack
Florentine Bronze Cylinder	201FB	201FBDP
Chrome Plate Cylinder	201CP	201CPDP
Satin Chrome Cylinder	201SC	-
<b>No Cylinder</b>		
Brown	201NOCYL	

# 100 Nightlatch



General purpose nightlatch.

## Features and Specifications

- Opened by key from outside and by turn knob inside
- Bolt may be held back by turning knob in clockwise direction

## Open Out Strike

Part Number SP201-67SC.

## Keying

- Supplied individually keyed with two keys per lock
- 78,000 key combinations
- Key blank KB2015P

## Restricted Special Keying

Lockwood locks can be keyed to a number of controlled and/or specially keyed systems. These range from legally protected keys to protect against unauthorised duplication, which can also include specially designed key systems such as master key systems, which allow for different levels of mechanical access control.

Please refer to Lockwood Keying Catalogue or contact your local sales office or customer service for specific information.

## Product Details

<b>Backset</b>	60mm
<b>Case</b>	High purity zinc alloy. 92mm wide, 64mm high, 43mm projection
<b>Cylinder</b>	5 pin tumbler mechanism Brass cylinder and brass barrel
<b>Door Thickness</b>	28 – 45mm
<b>Latch</b>	Brass. Reversible. 13mm projection
<b>Finish</b>	Lock Body : Brown (BRN) External Cylinder: Chrome Plate (CP) Florentine Bronze (FB)



# 100 Nightlatch

100



Exterior Cylinder

Interior

## 100 Nightlatch with Open In Strike

Finish	Trade Pack	Display Pack
Florentine Bronze Cylinder	100FB	100FBDP
Chrome Plate Cylinder	100CP	100CPDP

### No Cylinder

Brown	100NOCYL
-------	----------

## 100 Nightlatch with Open Out Strike

Finish	Trade Pack	Display Pack
Chrome Plate Cylinder	100-4CPSP	-

### No Cylinder

Brown	100-4NOCYL
-------	------------

# 211 Nightlatch



Medium security general purpose streamlatch.

## Features and Specifications

- Opened by key from outside and turn knob inside
- Inside snib may be used to holdback or deadlock bolt so that key will not operate
- Available in trade pack only

## Open Out Strike

Part Number SP201-67SC.

## Keying

- Supplied individually keyed with two keys per lock
- 78,000 key combinations
- Key blank KB2015P

## Restricted Special Keying

Lockwood locks can be keyed to a number of controlled and/or specially keyed systems. These range from legally protected keys to protect against unauthorised duplication, which can also include specially designed key systems such as master key systems, which allow for different levels of mechanical access control.

Please refer to Lockwood Keying Catalogue or contact your local sales office or customer service for specific information.

## Product Details

<b>Backset</b>	60mm
<b>Case</b>	High purity zinc alloy. 92mm wide, 64mm high, 43mm projection
<b>Cylinder</b>	5 pin tumbler mechanism. Brass cylinder and brass barrel.
<b>Door Thickness</b>	28 – 45mm
<b>Latch</b>	Brass. Reversible. 13mm projection

# 211 Nightlatch

211



Exterior Cylinder

Interior

## 211 Nightlatch

Finish	Trade Pack
--------	------------

Satin Chrome Pearl all over	211SPA0
-----------------------------	---------

### No Cylinder

Satin Chrome Pearl all over	211SPAONOCYL
-----------------------------	--------------

### No Cylinder No Snib Function

Satin Chrome Pearl all over	211SPAONOCYLNSF
-----------------------------	-----------------

# 200 Narrow Stile Streamlatch



General purpose streamlatch designed to suit narrow doors.

## Features and Specifications

- Opened by key from outside and turn knob inside
- Inside snib may be used to holdback or deadlock bolt so that key will not operate

## Open Out Strike

Part Number SP201-67SC.

## Keying

- Supplied individually keyed with two keys per lock
- 78,000 key combinations
- Key blank KB2015P

## Restricted Special Keying

Lockwood locks can be keyed to a number of controlled and/or specially keyed systems. These range from legally protected keys to protect against unauthorised duplication, which can also include specially designed key systems such as master key systems, which allow for different levels of mechanical access control.

Please refer to Lockwood Keying Catalogue or contact your local sales office or customer service for specific information.

## Product Details

<b>Backset</b>	38mm for narrow stile doors
<b>Case</b>	High purity zinc alloy. 68mm wide, 57mm high, 43mm projection.
<b>Cylinder</b>	5 pin tumbler mechanism. Brass cylinder and brass barrel.
<b>Door Thickness</b>	28 - 45mm
<b>Latch</b>	Brass. Reversible. 13mm projection.

# 200 Narrow Stile Streamlatch

200



Exterior Cylinder

Interior

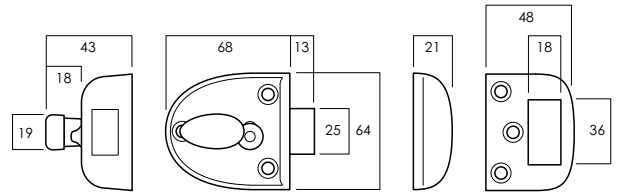

## 200 Narrow Stile Streamlatch

Finish	Trade Pack
Chrome Plate all over	200CPAO
Satin Chrome Pearl all over	200SPA0

# 213 Streamlock Deadbolt



General purpose deadbolt.

## Features and Specifications

- Locked or unlocked by key outside and by turn knob inside

## Open Out Strike

Part Number SP201-67SC.

## Keying

- Supplied individually keyed with two keys per lock
- 78,000 key combinations
- Key blank KB2015P

## Restricted Special Keying

Lockwood locks can be keyed to a number of controlled and/or specially keyed systems. These range from legally protected keys to protect against unauthorised duplication, which can also include specially designed key systems such as master key systems, which allow for different levels of mechanical access control.

Please refer to Lockwood Keying Catalogue or contact your local sales office or customer service for specific information.

## Product Details

<b>Backset</b>	60mm
<b>Bolt</b>	Brass. 16mm projection
<b>Case</b>	High purity zinc alloy. 92mm wide, 64mm high, 43mm projection.
<b>Cylinder</b>	5 pin tumbler mechanism. Brass cylinder and brass barrel. Suitable for all cylinder rim locks. Extruded brass cylinder.
<b>Door Thickness</b>	28 - 45mm

# 213 Streamlock Deadbolt

213

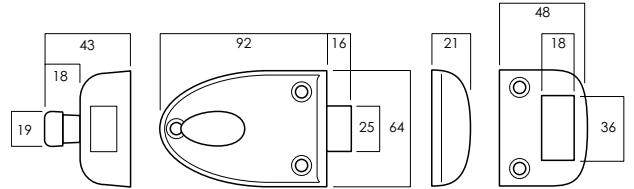

Exterior Cylinder

Interior

## 213 Streamlock Deadbolt

Finish	Trade Pack
--------	------------

Chrome Plate all over	213CPAO
-----------------------	---------

Satin Chrome Pearl all over	213SPA0
-----------------------------	---------

### No Cylinder

Satin Chrome Pearl all over	213SPAONOCYL
-----------------------------	--------------

# Nighlatch Accessories

## 201 Cylinder

Finish	Trade Pack	Display Pack
Chrome Plate	—	201CYLCPDP
Satin Chrome Pearl	—	201CYLSPDP
Polished Brass	—	201CYLPBDP
Florentine Bronze	—	201CYLFBDP

## Open Out Strike

Finish	Trade Pack
Chrome Plate	SP201-67CP
Florentine Bronze	SP201-67FB
Satin Chrome Plate	SP201-67SP

## 201 Cylinder with Solid Brass Cylinder

Finish	Trade Pack	Display Pack
Satin Chrome	201-252SC	—

## 213 Case Assembly

Finish	Trade Pack
Satin Chrome Pearl	SP213-4SP





**ASSA ABLOY**

**Lockwood** is the leading brand in the Australian locking industry. With an established reputation for high quality products, this iconic brand provides a wide range of locking solutions to residential housing, commercial, semi-commercial, building and industrial application markets. Lockwood is supported by an extensive distribution and after-sales support network. Our customers include retailers, architects, trade and industrial personnel, locksmiths and security dealers.

**ASSA ABLOY** is the global leader in door opening solutions, dedicated to satisfying end-user needs for security, safety and convenience.

**ASSA ABLOY** is represented in all major regions, in both mature and emerging markets, with leading positions in Australia, Europe and North America.

**25YEAR  
MECHANICAL  
WARRANTY**

### The Lockwood 25 Year Mechanical Warranty

Our belief that we manufacture the finest premium products available in today's market place is backed by the Lockwood 25 Year Mechanical Warranty, ensuring that Lockwood continues to keep Australians safe by delivering security and peace of mind.

For warranty terms and conditions, please visit [www.lockweb.com.au](http://www.lockweb.com.au) or call **1300WARRANTY**

**ASSA ABLOY Australia Pty Ltd**  
235 Huntingdale Road  
Oakleigh, Victoria, 3166  
Australia

**1300 LOCK UP (1300 562 587)**  
[lockweb.com.au](http://lockweb.com.au)

**ASSA ABLOY New Zealand Ltd**  
6 Armstrong Road  
Albany, Auckland, 0632  
New Zealand

[info.nz@assaabloy.com](mailto:info.nz@assaabloy.com)  
Telephone +64 9415 7111  
[assaabloy.co.nz](http://assaabloy.co.nz)



*Purchase Lockwood products through Access Hardware to earn 1 Qantas Point per \$1 spent for your business\*. Find out more by calling Access Hardware customer service on 1800 555 600 or visit [accesshardware.com.au](http://accesshardware.com.au)*

\*A business must be a Qantas Business Rewards member to earn Qantas points for business. Membership and Qantas Points are subject to Qantas Business Rewards Terms and Conditions at [qantasbusinessrewards.com/terms](http://qantasbusinessrewards.com/terms) and Access Hardware Terms and Conditions at [www.accesshardware.com.au/qbr](http://www.accesshardware.com.au/qbr)

Customer Service  
**1800 555 600**

Locksmithing  
**1800 555 700**

#### Disclaimer

Whilst every effort has been made to ensure that the information (including product images and drawings) contained in this brochure is accurate at the time of publication, ASSA ABLOY Australia Pty Limited ("ASSA ABLOY") recommends that you consult ASSA ABLOY or its agents prior to placing an order to ascertain current information on specific products, as ASSA ABLOY reserves the right to make changes without notice. ASSA ABLOY will not be liable for any injury, loss or damage whatsoever, arising from any errors or omissions in the information contained in the brochure or arising from the use or application of the information contained herein. © 2017 copyright by ASSA ABLOY All rights reserved

