



INSTRUCTIONS

SIRUI HC Series Electronic Humidity Control Cabinet

202009

**Thank you for purchasing SIRUI Electronic Humidity Control products.
Please read this manual before using.**

CONTENT

1. Features	1
2. Safety Instructions	1
3. Safe Operation	1
4. Operation	3
5. Operation Method	4
6. Caution	5
7. Possible problems and troubleshooting.....	5
8. Humidity recommendations	6
9. Packing List	7
10. HC series specification	7
11. The theory of the Photocatalysis, and an Introduction to the Photocatalysis tests	8

Guangdong SIRUI optical co.,ltd.

Address: The Third Industrial District, Wuguishan Town, Zhongshan City, Guangdong, China

Tel: 0086-760-88897373 Fax: 0086-760-88207062

Service Hotline: 0086-400-8302299 <http://www.sirui.com>

1 Features

(1) Introduction of Product Use

The SIRUI Electronic Humidity Control Cabinet can effectively prevent mildew, fogging, oxidation, corrosion, material deformation, and can reduce the possibility of fracture and failure of electronic devices, etc. The regulated environment of the SIRUI Cabinet helps extend the life and value of your most precious possessions.

- ※ Ideal for storing paintings and papers, including calligraphy, antiques, paper currencies, ancient books, fax paper, copy paper, printing paper, etc.
- ※ Ideal for storing optical & electronic devices, such as advanced lenses, photographic equipment, camcorders, computer items, cameras, lenses, microscopes, CDs, telescopes, film, videotapes, microfilms, Slides, etc.
- ※ Ideal for storing precision materials, such as gold/silver and other precious metals, non-metals, metal powder products, electrical equipment, semiconductors, condensers, printed circuit boards, tungsten wires, IC, batteries, etc.
- ※ Ideal for precision machinery equipment products such as crystals, precision measuring tools, optical lenses, optical scanners, spectrometers, etc.

(2) Product Features







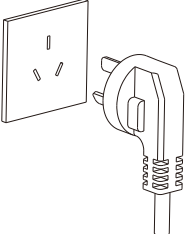

- ※ The SIRUI Electronic Humidity Control Cabinet contains a high performance dehumidifying system with precise microcomputer control, for automatic, worry-free operation.
- ※ Easy-to-read LCD digital display of temperature and humidity.
- ※ The dehumidifying system is made of fire-resistant material and is quick, high-efficiency, energy saving and non-polluting.
- ※ The internal design of the humidity control elements protects the components from damage and people from inadvertently touching it.
- ※ The cabinet body is made with high strength steel that is precision welded with high frequency argon arc equipment.
- ※ The door is made of high-quality, tempered glass, which is waterproof, dust-proof and airtight.
- ※ Low humidity inside the cabinet can be maintained for a long time after the power is turned off.
- ※ All the SIRUI Electronic Humidity Control Cabinets incorporate a Photocatalyst - a safe, powerful bacteriostatic antiseptic with antifungal, purifier and cleaning functions.

2 Safety Instructions

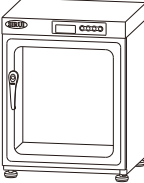
- ※ Please confirm the power supply is AC 110V~240V 50/60Hz before using.
- ※ Do not put your finger or stick anything into the grill on the back of the Cabinet.
- ※ Inexperienced people and children must use the cabinet under careful supervision and guidance.
- ※ Children should be supervised and should not play with or near the cabinet.
- ※ If the power cord is damaged, it must be replaced with an equivalent power cord. Contact the selling dealer or SIRUI for replacement parts.

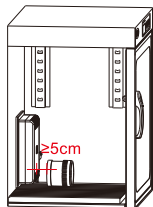
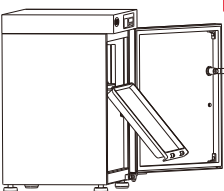
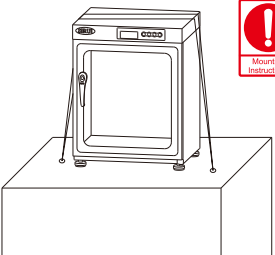
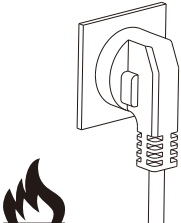
3 Safe Operation

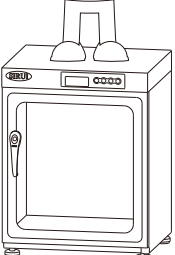
Please use the cabinet correctly, to prevent damage to the product or harm to yourself.

 Operating Instructions (Please follow the instructions to prevent damage to the product or harm to yourself.)		
 <p>AC 110V~240V 50/60Hz</p>	  	 <p>≥5cm</p>
<p>Humidity control cabinet uses single phase alternating current AC 110V~240V 50/60Hz power source.</p> <p>Improper use of power source may cause fire or high temperature.</p>	<p>Do not put the cabinet near an air-conditioner vent or in a room with changeable temperature, direct sunlight or excessive dust.</p> <p>Which may weaken the function of humidity removal.</p>	<p>Keep the goods inside the cabinet at least 5cm (2inches) away from the Humidity Control Component.</p> <p>For proper air circulation and heat release.</p>
		
<p>Use of excessive force when pulling out the shelves from the cabinet may cause the shelves to fall out or be damaged.</p>	<p>The cabinet must be attached to the wall or a sturdy object if the cabinet will be placed on a high surface.</p> <p>To prevent the cabinet from falling and causing damage or personal injury.</p>	<p>If there is any abnormal running or smell, please pull out the power plug immediately.</p> <p>Fire or electric shock may occur.</p>
 Warning! (Follow the instructions to prevent serious harm or damage.)		
		
<p>Do not put objects on top of the cabinet or step on the cabinet.</p> <p>This may damage the cabinet and/or cause personal injury.</p>	<p>Do not put flammable and explosive things into the cabinet.</p>	<p>Do not cover the vents behind the cabinet.</p> <p>Which may cause heat buildup and possible product failure.</p>

4 Operation

(1) Appearance

The following picture is only an example for instructional purposes. The actual appearance of your cabinet may be different from the picture.

Caution

Start and Run the cabinet for 4 hours before placing items in the cabinet.
 Accuracy of the humidity control is +/- 5% RH
 Factory pre-set of the cabinet internal humidity is 25%RH



Serial number on the back of the cabinet

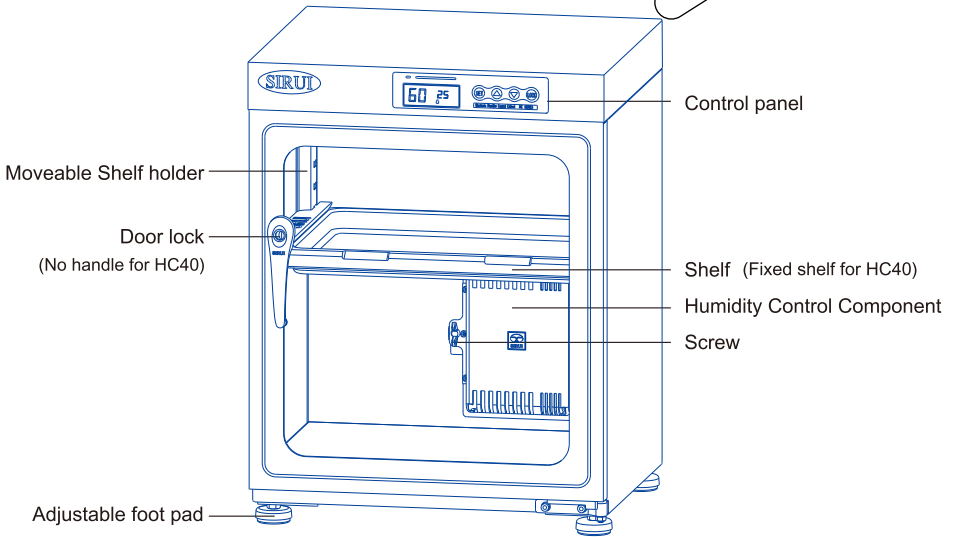

(2) System Control

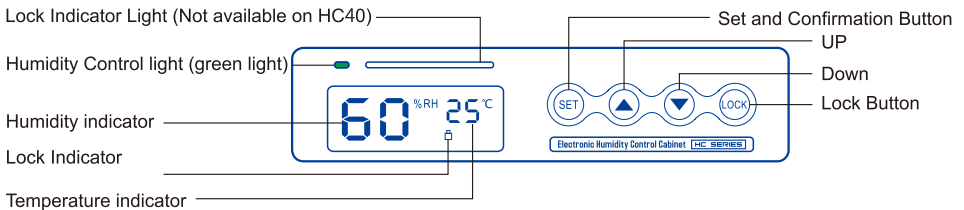

5 Operation Method

(1) Humidity setting

When you plug in the HC, the system will scan automatically. After 30 seconds, the system will go into Power Saving Mode. Please refer to “Object Storage Humidity Reference Table” (Page 6) to find the corresponding humidity you want (the factory setting of the cabinet is 25% RH).

Unlock the display by pressing the “LOCK” button for 2 seconds. Set your desired humidity by pressing the “SET” button first (the current humidity number will be flashing), then press the “▲” / “▼” button to make this number increase/decrease. (The number will keep increasing/decreasing until you release the “▲” / “▼” button). Press “SET” again, when you have the number you want. Now the humidity you set is recorded and the system is automatically back to normal operational mode.

(2) Keypad Lockout Function

The system will automatically lock after 10 seconds, if you do not touch the control panel ( sign appears). This means that any operation、 (like pressing “▲” or “▼”、“SET”) will not function.

(3) Unlock the keypad

Press the “LOCK” button for 2 seconds and the  sign disappears. You can then control the “▲” or “▼”、“SET” buttons.

(4) Internal lighting and door open/locked indication (Not available on HC40)

When you open the door, the interior cabinet light goes on and the Lock Indicator Light on the Control Panel goes on to indicate that the door is open. When closed, the Lock Indicator Light will go off and the door will lock.

(5) Activate the LCD’s backlight

The LCD screen backlight and keypad illumination function turns on when you press any button on the control panel in normal working mode. The light will turn off after 30 seconds.

(6) Shelf setting (Fixed shelf for HC40)

- ※ Please do not touch the internal Humidity Control Component when setting up the shelf and guide rail system.
- ※ Both guide rails must be set on the same slot height to ensure that the shelf is horizontal.
- ※ Set up the shelf and check whether the shelf is fixed.
- ※ Improper setting of the shelf may cause blocked moisture absorption window or affect the ventilation inside the cabinet.

① Shelf guide rail system setting

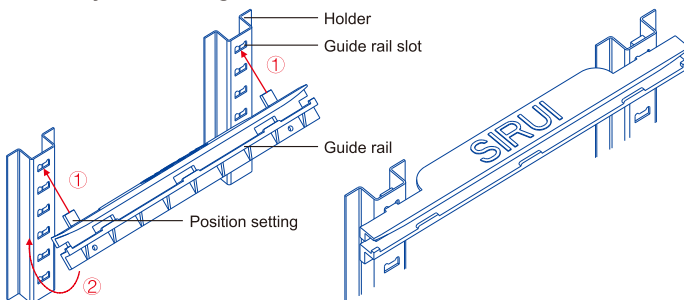

② Take out the shelf

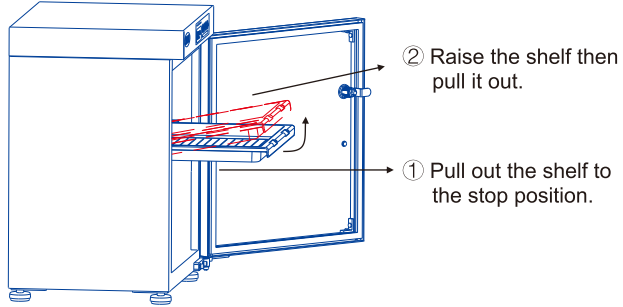

6 Caution

1. Do not touch the power plug with wet hands, otherwise it may cause personal harm.
2. If the power cord is aged, broken, loose, or unusually hot, please replace it immediately to avoid fire.
3. When the cabinet is maintained, cleaned or moved, please turn off the power. Please pull out the power plug if the cabinet will not be used for a long time.
4. Do not put corrosive products like chemicals, flammable or explosive items into the cabinet, otherwise it may cause a fire or explosion.
5. Do not clean the cabinet with water. This may damage the electronics and cause a potential shock or fire hazard.
6. Make sure the items inside the cabinet are about 5cm away from the Humidity Control Component so that the system can be properly ventilated and heat can be dispersed.

7 Possible problems and troubleshooting

Problem	Possible reason	Solution
Still doesn't work when turned on	Is Power cord plugged in properly?	Make sure power supply and plug are in good condition and fully plugged into the outlet.
Humidity is not going to desired level	Does the article contain too much moisture?	Dry the article with fan before putting it in the cabinet.
	Inappropriate humidity setting.	Refer to the humidity recommendation for your article and set the proper one.
	Internal humidity is much higher than outside environment.	Set the internal humidity lower than outside environment.
	Opening or closing the door too often.	Reduce the number of times and length of time the door is opened.
	a. High heat from a nearby oven or other heat generating equipment may affect efficiency. b. The blowing from the air outlet of the air conditioner, fan or other equipment may affect air convection. c. The inner articles may block the ventilation outlet.	Stay away from places with high temperatures and strong airflow, Rearrange the inner articles to allow sufficient airflow or remove some articles. Do not block the ventilation outlet.

Caution

1. Run the cabinet for 4 hours before placing items into the cabinet.
2. The temperature of the cabinet system will rise when it starts dehumidifying. It will last about 35 minutes (different size cabinets will take longer or shorter periods of time to stabilize).
3. Please fan dry items with lots of moisture, like paper, clothes, packing materials before putting into the cabinet.

When the Humidity Control Component is not working, please remove the Component as follows (the power must be shut off first):

1. For HC Series Cabinets (HC40 excluded)

① Unscrew the 2pcs of M4 Screws, remove the cover of the Power Socket.

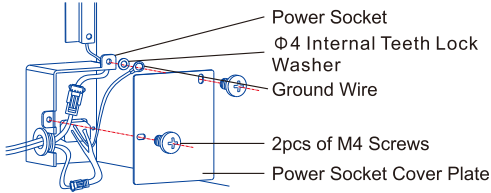

② Unplug the Wire Connector.

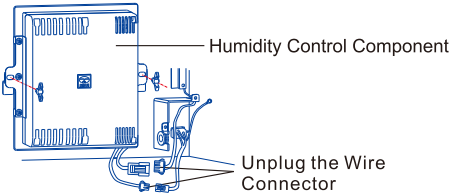

③ Loosen the 2pcs of Wing Bolts connected to the Humidity Control Component, then the Humidity Control Component can be dismantled.

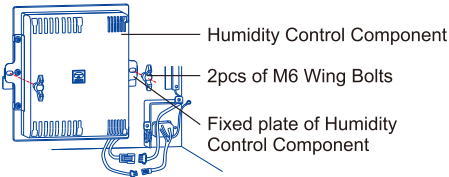

2. For HC40 Cabinet

① Unscrew the 1pc of M3 Screw, remove the Ground Wire.

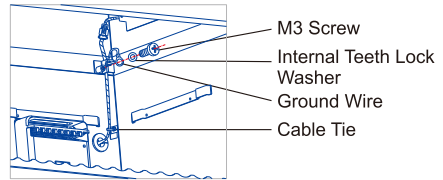

② Cut off the Cable Ties in 2 places, pull out the Wire Connector from the Humidity Control Component, take the wire and earth wire from the Cable Ties.

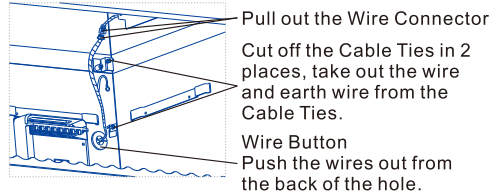

③ Remove the 4pcs of the M3 Screws at the back panel of the cabinet, pull out the wires from the wire buckle, and disassemble the Humidity Control Component of the Cabinet.

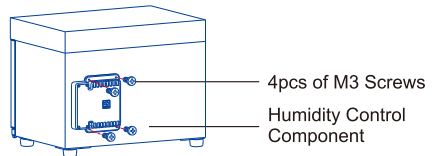

8 Humidity recommendations: Reference Table

Relative humidity	Storage Items
55%-60%RH	Paper material: paintings, antiques, paper currency, old books, fax paper, copy paper, typing paper.
45%-55%RH	Optical equipment: video camera, acoustics, computer equipment, cameras, lenses, microscopes, CDs, telescopes, endoscopes, negative film, video tapes, microfilm, disk drives, lantern slides.
35%-45%RH	Precise Material: metal, nonmetal, metal powder product, electrical equipment, electronic product, semiconductors, capacitors, Printed Circuit Boards, tungsten filament, IC, battery. Precision machinery & instrument products: accessory, crystal, precision measuring tools, optical glass, spectrometer etc.
35%-25%RH	Chemical raw materials: pharmacy raw materials, spices, paint, powder, powder material, adhesives. Farm supplies: seeds, pollen, dried flowers.



Attention

The equipment cannot be used when the external relative humidity is lower than 25%

9 Packing List

S.N.	Description	Unit	HC40	HC50	HC70	HC110	HC200
1	Detachable power cord with 2/3 prong connector	set	1	1	1	1	1
2	Spare key	pcs	2	2	2	2	4
3	Moveable Shelf	pcs	1	1	2	3	4
4	Shelf bracket	pcs	0	2	4	6	8
5	Shelf mat	pcs	2	2	3	4	6
6	Instructions	pcs	1	1	1	1	1

10 HC series specification

Model	HC40	HC50	HC70	HC110	HC200
Capacity (L)	40	50	70	110	200
Weight (kg)	8.4	12.7	16.2	23.5	36.5
Dimensions(mm) height×width×depth	420×400×330	520×400×335	680×400×335	820×450×380	1250×450×420
Humidity control mode	Fully automatic electronic humidity control				
Door material	Aluminum door frame, silk print tempered glass (PVC door frame for HC40)				
Cabinet body material	Cold rolled steel with powder coating				
Nominal voltage	AC 110V~240V 50/60Hz				
Power consumption (kW/month)	1.0 ~ 2.5	1.3 ~ 3.4	1.3 ~ 3.4	1.3 ~ 5.3	1.5 ~ 5.3
Quantity of shelves (set)	1	1	2	3	4

Product specifications are subject to change without prior notice.



HC40



HC50



HC70



HC110



HC200

**Revolutionary industry innovation—
SIRUI creates high performance,
mildew-proof humidity control cabinets.**



Principles of Photocatalyst TiO₂

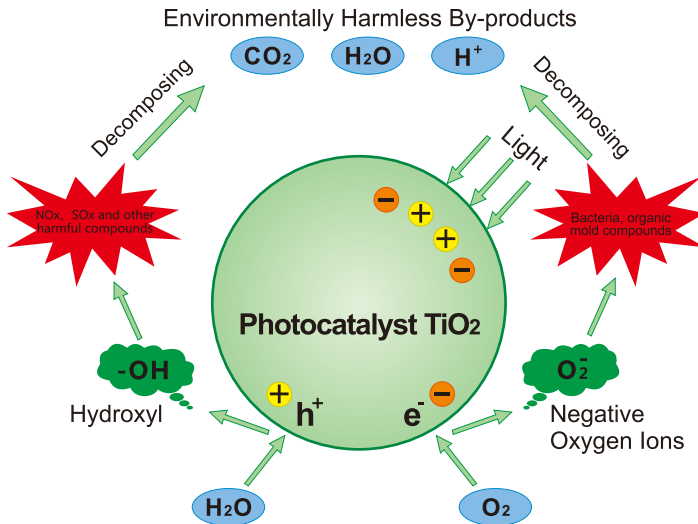

Under irradiation of light, Photocatalyst TiO₂ will produce a photocatalytic reaction like photosynthesis - oxygen. Due to the absorption of light energy, the interior will be excited and generate electron hole pairs (photo-generated carrier). The electron hole pairs will move to the surface of the Photocatalyst TiO₂ immediately and activate the adsorbed (stuck to the outside surface) oxygen and moisture, producing reactive free hydroxyl (-OH) and reactive oxygen (-O). The Photocatalyst TiO₂ has potent light oxidation reduction performance, and can oxidize and decompose all organic compounds and some inorganic substances. When the pollutant and bacteria adsorb onto the surface of the Photocatalyst TiO₂, chain degradation reaction will occur, and convert the organic pollutant into harmless, pollution-free water (H₂O) and carbon dioxide (CO₂). This makes the Photocatalyst TiO₂ capable of sterilizing, deodorizing, mildew-proofing, dust-proofing, self-cleaning and purifying.

Photocatalyst TiO₂ converts the contacted organic compounds into CO₂ and H₂O with the oxygen molecule and water molecule in the air. The Photocatalyst TiO₂ itself doesn't change, but can promote a chemical reaction. The chemical reaction will last long, so the operating cost will be low. Photocatalyst itself is non-toxic and harmless, it has been widely used in the area of food, medicine, cosmetics, etc.



Photocatalyst TiO₂ Testing Group

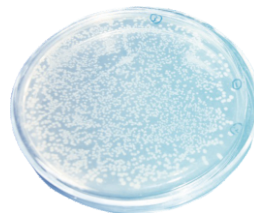

Control Group

SIRUI Electronic Humidity Control Cabinet with Photocatalyst TiO₂



Deodorizing

Sterilizing

Moisture
-proof

Testing Report for the germicidal rate of SIRUI Electronic Humidity Cabinets

The test report indicated: After operating the 50L cabinet for 1 hour, reduction of the bacterium - *Staphylococcus albus* 8032 - was 82%.

GUANGDONG DETECTION CENTER OF MICROBIOLOGY

REPORT FOR ANALYSIS

Name of Sample	SIRUI ELECTRONIC HUMIDITY CONTROL CABINET	Way and Quantity of Reception	One Sample Submitted
Spec and Lot No. of Sample	HC Series/HS Series	State and Characteristic	Enginery
Applicant	Zhongshan SIRUI Photographic Equipment Industry Co., Ltd	Sample Received Date	2014/01/15
Test Item	Disinfection efficiency for air	Testing Period	2014/01/15 to 2014/01/23
Report No.	2014FM0121-1aE	Date for Reporting	2014/02/10
Test Method	Referred to Technical Standard for Disinfection (2002 Ministry of Health P.R.China)2.1.3		

RESULTS

Action time(hr)	The tested organism	Serial Number	The number of Bacteria in the air (cfu/m ³)	Reduced rate (%)
0 (CK)	<i>Staphylococcus albus</i> 8032	1	4.6×10 ⁷	
		2	4.5×10 ⁷	
		3	4.7×10 ⁷	
2h	<i>Staphylococcus albus</i> 8032	1	7.8×10 ⁵	83.04
		2	7.9×10 ⁵	82.44
		3	8.0×10 ⁵	82.98

Test results showed that after turning on the sample for 1 hour in the 50L test chamber, *Staphylococcus albus* 8032 reduction rate was 82%.

(blank below)

Remarks

- 1.Method description:Spot test:after operating purifiers,sample the air with the flow of 11L/min by pump liquid aerosol sampler,the sampling time is 2 minutes,the test room is 50L.
- 2.Killing rate test has been eliminated the influence of natural death of microorganisms in the test.
- 3.Manufacturer: Zhongshan SIRUI Photographic Equipment Industry Co., Ltd.

Editor: Chen Jingting Verifier: Li Liangqiu Approver: Wu Dongfang Official Seal: 检测专用章

SIRUI HC series Electronic Humidity Control Cabinets are all manufactured with Photocatalyst TiO₂ - a safe specialized coating that makes the cabinets anti-bacterial, sterilizing, purifying, deodorizing and mildew-proofing – further enhancing their dust-proof and humidity controlled environment.

Testing Report for the removing rate of pollutants by SIRUI Electronic Humidity Cabinets (Harmful fumes from substance like Formaldehyde, Benzene, etc.)

The testing report indicated: After operating the 50L cabinet for 24 hours, the removal rate for the Formaldehyde was 83.9%, and the removal rate for the Benzene was 86%.

GUANGDONG DETECTION CENTER OF MICROBIOLOGY
REPORT FOR ANALYSIS

Name of Sample	SIRUI ELECTRONIC HUMIDITY CONTROL CABINET	Way and Quantity of Reception	One Sample Submitted
Spec and Lot No. of Sample	HC Series/HS Series	State and Characteristic	Engineering
Applicant	Zhongshan SIRUI Photographic Equipment Industry Co., Ltd	Sample Received Date	2014/01/15
Test Item	See the following table	Testing Period	2014/01/16 to 2014/01/21
Report No.	2014FM021-2AE	Date for Reporting	2014/02/10
Test Method	QB/T 2761-2006		

RESULTS

Test pollutants	Action time(hr)	Result		Removal rate (%)
		The initial concentration (mg/m ³)	The Concentration of test cabin (mg/m ³)	
Formaldehyde	24h	2.05	0.33	83.9
Benzene	24h	4.15	0.583	86.0

Test results showed that: after turning on the sample for 24 hours in the 50L test chamber, the pollutant formaldehyde removal rate was 83.9%, and the benzene removal was 86%.
(blank below)

Remarks

1. The experiment was performed at the 50L test cabin.
2. Manufacturer: Zhongshan SIRUI Photographic Equipment Industry Co., Ltd.

Editor: Chen Yingting Verifier: Li Liangqiu Approver: Wu Dongfeng Official Seal:

Page 2of 3

Warranty Card

Dear Customer,

Thank you for your purchase of Sirui professional products!
 Sirui warrants that your purchase is free from defects in materials and workmanship, under normal use during the Limited Warranty period. The warranty period starts on the original date of purchase on your sales receipt. If service is required, please include a copy of the sales receipt and this warranty card, with an explanation of the problem. Please store your sales receipt and warranty card in a safe location. SIRUI service hotline: 400 830 2299



Model _____

Purchase date _____

Store Name _____

Store Phone _____

Store Address _____

Stamp or seal _____

Buyer reading:

- (1) The Sirui cabinet comes with a 6-year warranty. (The electronic parts have a 3-year warranty). The warranty period starts on the original date of purchase on your sales receipt.
- (2) This warranty is only valid when product is purchased from an authorized SIRUI dealer or online shop.
- (3) If service is required on the cabinet: Please confirm the problem by contacting your dealer or SIRUI directly. Remove the problem parts and send only those parts to the SIRUI factory for repair. Please refer to the instruction manual or call our service hotline for more information.
- (4) Warranty repair will not be provided, under the following circumstances:
 - ① The warranty period is over.
 - ② The product was not purchased from an authorized SIRUI dealer.
 - ③ The product was repaired by an unauthorized agency or unauthorized repair center.
 - ④ Damage was caused due to improper operation, accident, natural disasters.

Warranty Address and Contact Information:

(Please contact the seller or the local distributor where the product was purchased for warranty issues or questions and before any product is sent.)

1. Guangdong SIRUI Optical Co., Ltd.

The Third Industrial District, WuguishanTown, ZhongshanCity, Guangdong, China

Tel: 0086-760-88897373

Fax: 0086-760-88207062

[Http://www.sirui.com](http://www.sirui.com)

E-mail: info@sirui-photo.com

Service Hotline: 0086-400 830 2299

Complaint Hotline: +86-181 6563 9388

(Monday to Friday: 8:15am~12:15pm, 14:00pm~18:00pm)

2. SIRUI USA, LLC

Add: 29 Commerce Court Verona, NJ 07044

www.sirui.com

Service: Toll Free 866-373-0829 E-mail: info@sirui.com

FOR PRODUCTS PURCHASED IN THE USA PLEASE SEE:

For full details on USA Warranty Terms and Limitations:

<https://www.siruiusa.com/warranty.html>

To register products: <https://www.siruiusa.com/product-registration.html>

3. European Service Center

Add: SIRUI Optical GmbH • Ernst-Augustin-Str.1a • 12489 Berlin • Germany

Phone: +49 30 991 94 94 00 • Email: Info@siruioptical.eu