



13060 - Sherman M4A3 76mm Airsoft BB Edition

13065 - Sherman M4A3 76mm Infrared Edition

TAIGEN TANKS

M4A3 SHERMAN 76MM

1/16TH **2.4GHZ** MEDIUM TANK

Proportional Throttle • Proportional Steering • Safety Firing Switch • Barrel Elevation • Turret Rotation • Smoke Unit • Sound System • Track Recoil • 2.4GHz Radio System • 2000mAh Battery with Charger • Steering Trim • Tow Hooks • Steel Gearboxes • Available in Airsoft or Infrared Models



PAINTING
AIRBRUSH

SMOKE AND
SOUND UNIT

AGE **14+**

INSTRUCTION MANUAL

- Engine, elevation, turret rotation, and firing sounds with adjustable volume
- Shoots while driving!
- Realistic smoke unit for exhaust simulation
- 2.4GHz Radio System



NOT A TOY! THIS MODEL IS NOT SUITABLE FOR CHILDREN UNDER THE AGE OF 14!

TABLE OF CONTENTS



13060 - Sherman M4A3 76mm Airsoft BB Edition
13065 - Sherman M4A3 76mm Infrared Edition

TAIGEN TANKS

PAGE CONTENTS

- 1 Cover Sheet
- 2 Table of Contents
- 3 Tank Model Introduction
- 4 General Notes, Declaration of Conformity, Customer Service
- 5 Warning and Safety Notes, Disclaimer of Warranty
- 6 Warning Notes
- 7 Warning Notes, Set Content
- 8 Battery Pack - Charging + Safety Notes
- 9 Inserting + Connecting Batteries (Tank + RC)
- 10 Remote Control (Functions); Steering the Tank

PAGE CONTENTS

- 11 Start-up Devices; various Settings and Functions; Super Spin
- 12 Operating Turret + Gun, Shooting Function
- 13 How to load BB-Bullets, Hop-up System, Target Setup
- 14 Infrared Battling and Setup
- 15-16 How to Install Appendant Parts
- 17 Application of Decals
- 18 Maintenance, Spare Parts Service, Warranty Exclusions
- 19 Technical Data + Features
- 20 Remote Control Functions, Code-Binding, Pin Slot Configuration Printed Curcuit Board (PCB)

M4A3 SHERMAN 76MM



U.S.M4A3 SHERMAN

The M4 Sherman, officially the Medium Tank, M4, was the primary battle tank used by the United States and the other Western Allies in World War II, and proved to be a reliable and highly mobile workhorse, despite being outmatched by heavier German tanks late in the war. Thousands were distributed to the Allies, including the British Commonwealth and the Soviet Union, in the lend-lease program. The M4 was the second most produced tank of the World War II era, after the Soviet T-34, and its role in its parent nation's victory was comparable to that of the T-34. The tank took its name from the American Civil War General William Tecumseh Sherman.

The M4 Sherman evolved from the M3 Medium Tank (a.k.a. Grant and Lee), which had an unusual side-sponson mounted 75 mm gun. It retained much of the previous mechanical design, but added the first American main 75 mm gun mounted on a fully traversing turret, with a gyrostabilizer enabling the crew to fire with reasonable accuracy while the tank was on the move. The designers stressed mechanical reliability, ease of production and maintenance, durability, standardization of parts and ammunition in a limited number of variants, and moderate size and weight. These factors made the M4 superior in some regards to the earlier German light and medium tanks of 1939-41. The M4 went on to be produced in very large numbers. It formed the backbone of most offensives by the Western Allies, starting in late 1942.

All spare parts and the whole variety of our models are also available at our internet shop (www.taigentanks.com)



TAIGEN TANKS

Frequency 2.4 GHz
approved for EU / CH



ATTENTION

Important supplement to manual of your RC model. Do read this supplement and the manual carefully and entirely before operating the model and the remote control.

IMPORTANT INFORMATION

Telecommunication Regulations:

When using a remote control device, please observe the current legislation of the country the device is being used in. If you have any questions, please contact our service department or your local dealer.

Declaration of Conformity

When using a remote control device, please observe current legislation of the country the device is being used in. This RC model conforms with all relevant US laws and all basic requirements and regulations of the R & TIE directive 1999/5/EU of the European Community.

This model includes a transmitter and receiver. If you have any questions regarding the conformity or if you wish to exercise your right of access, please contact our service department or contact your local dealer.

Notes for disposal of batteries and electronic parts:

Please deposit battery packs and all electronic parts (remote control, charger, rc model, etc.) according to local laws and regulations. Protect the environment!

Product Questions

Please call or email our service department if you have any questions or issues.

Do not send in items before having contacted our service department and making arrangements.



TAIGEN TANKS

IMEX Model Co.
15391 Flight Path Drive
Brooksville, FL 34604
Tel. (352) 754-8522

www.taigentanks.com



Caution Notes. Please read this instruction manual carefully before use.

The manufacturer is not liable for injuries and accidents caused by improper use, alteration, or disassembly of the product. Such altered or disassembled products will not be repaired by the manufacturer.

- Never try to disassemble or alter the product to avoid malfunction or danger. Such products will not be repaired by the manufacturer.
- No repair services will be offered for products which have been altered or disassembled by the user in any way!
- Should the tank or the remote control get wet due to rain or immersion into water, stop operating the tank because this may cause malfunctions. Remove all batteries and consult with your local dealer.
- Do not expose the tank or the remote control to strong sunlight. This may cause deformation or malfunction.
- Keep this manual for further reference. If the manual is lost, contact your dealer.

SAFETY NOTES AND DISCLAIMER OF WARRANTY

Tank models are not toys for children. Only responsible and careful acting persons may use the model. Exact work, technical understanding, and a safety-oriented attitude are absolutely necessary when assembling and operating the tank. Each mistake during assembly or operation can result in severe damages or injuries. If you are unexperienced in using model vehicles, do let a person with experience show you how to operate such models.

Never operate the tank near people, animals, or on public roads in order to avoid accidents. Always make sure that there are no persons or animals or any obstacles close to the operating area. Check the model for damages before each use and make sure that only a model free from any damages or problems will be operated.

Do switch on the transmitter first and then the RC model. Check the operating distance in the terrain you are using the model in to get a feeling for the maximum operating distance. When switching off the devices, switch off the model first and then the transmitter.

You as the holder are liable for damages which occur as a result of operating a model vehicle. Taigen does not have any control over the handling, the compliance with assembly and operation notes as well as the actual operation of the model and its maintenance. Therefore, Taigen is not liable for any damages, losses, or costs of any kind. Taigen repudiates liability for each and every compensation claim, which results from operating or using the tank or its components or which relates to such operating or using. We are not liable for any injury to persons, material damages, and the consequences therefrom, which result from our delivery.

⚠ Caution Notes. Please read this instruction manual carefully before use of model.

This RC battle tank is not a toy but a tank model controlled by radio signals. Its integrated airsoft gun is very powerful and accelerates the plastic BB bullets to high velocities with a shooting distance of up to 25 meters or 80 feet. Please use carefully to avoid injuries and damages.

Please read through the following caution notes!

This tank features an integrated airsoft gun. Use carefully to avoid injuries through accidental shooting or misuse!

⚠ Wear goggles!



During shooting all persons in the immediate vicinity should wear goggles. Bullets may ricochet off walls and other hard surfaces!

⚠ Shut down all systems after use.

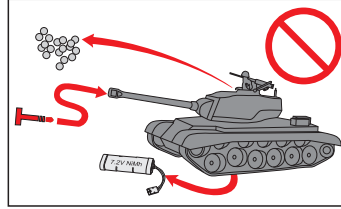

- After use set main switch to "OFF", then set shooting switch to "OFF".
- Insert protective cap into gun muzzle.
- Remove BB bullets by turning tank upside down so that bullets may drop out of the tank.
- Remove batteries to avoid discharge or leakage.

⚠ Do not shoot at people or animals!

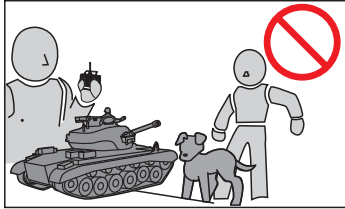

Do not aim or shoot at people or at animals. You might be subject to criminal punishment.

⚠ Never look into the gun muzzle!

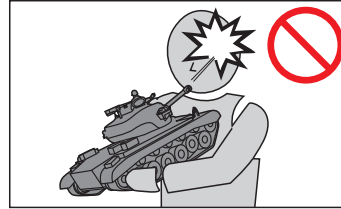

To protect your eyes, never try to look into the gun muzzle, whether there is a bullet inside or not. Please also note that accidental shooting may be triggered by a poor radio signal!

⚠ Do not use tank near or on public roads!

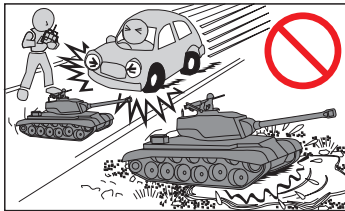

Do not use tank at or on public roads to avoid traffic accidents. Also, do not play in water pits, on sand, or on carpets in order to avoid malfunctions.

⚠ Never shoot in public places or areas!

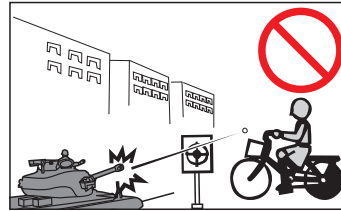

Do not shoot in areas or places with people or cars passing by. This might cause accidents or injuries.

⚠ Avoid swallowing of small parts by infants and small children!



Keep small parts and packing material out of reach of infants and small children in order to avoid accidental swallowing of such parts or material.

⚠ Do not put hands in between the wheels or onto the tracks.

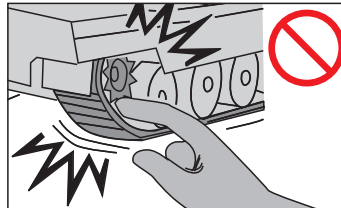

Keep hands or fingers away from wheels and tracks to avoid injuries. To hold or lift the tank do not use wheels or tracks in order to avoid damage and/or malfunctions.

⚠ Keep antenna away from faces!

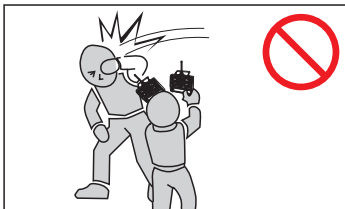

The end of the antenna may lead to eye injuries. Do not bring antenna too close to faces. The sharp end of a broken antenna may cause serious eye injuries. Refer to your local dealer for a new antenna.

⚠ FOR IR-VERSION, ONLY: Do not use infrared battle system in strong sun light!

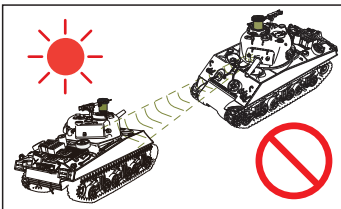

Strong sun light may affect the infrared controlled battle functions of the tank and cause malfunctions. It is recommended not to use the IR battle functions under such conditions.

⚠ The manufacturer is not liable for injuries and accidents caused by improper use, alteration, or disassembly of the product. Such altered or disassembled products will not be repaired by the manufacturer.

- Do not point gun at fragile or other easily breakable objects such as glass, lamps, electric appliances, tableware, or furniture.
- Bullets other than the specified BB bullets may easily cause blockage. Do not put any improper bullets or other objects into the bullet container or the gun muzzle.
- Never try to disassemble or alter the product to avoid malfunction or danger. Such products will not be repaired by the manufacturer.
- Should the tank or the remote control get wet due to rain or immersion into water, stop operating the tank because this may cause malfunctions. Remove all batteries and consult with your local dealer.
- Do not expose the tank or the remote control to strong sunlight. This may cause deformation or malfunction.
- Keep this manual for further reference. If the manual is lost, contact your dealer.

INSTRUCTION MANUAL



Warning Notes

Not following the warning notes may cause injuries and malfunctions. Please follow all warning notes !



Use tank indoors only, outdoor use at your own risk !

This tank is a high-precision product and should be used with care. Avoid shocks and dust, sand, or stones entering the body or the wheels and tracks.

This also applies for the remote controller. Manufacturer is not liable for damages or malfunctions because of warning notes not being followed.

PLEASE, DO FOLLOW ALL WARNING AND SAFETY NOTES IN THIS MANUAL !

Not part of product contents.
(Batteries remote controller)

- 6X AA Batteries



Be careful when using tools !



Warning Note Batteries



Do not use damaged batteries to avoid short circuit !



Do wear safety goggles during shooting !



(With airsoft gun version only)

SET PARTS



Make sure the tank functions correctly before installing the accessories.

MANUAL



Infrared Receiver port.

The infrared receiver must be plugged in to infrared battle.

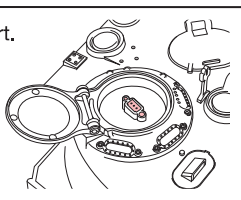

Airsoft Safety Switch

This is a safety switch for the airsoft firing unit. If turned off the tank will not fire bullets.

Bullet hatch

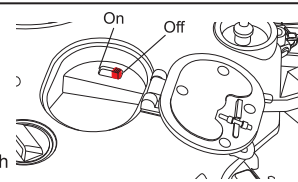

Gun Barrel

Turret

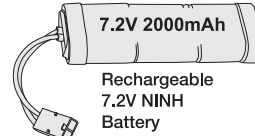

Rechargeable 7.2V NINIH Battery



REMOTE CONTROL



2.4 GHz

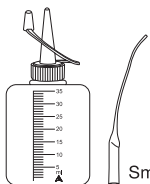

Smoke Fluid

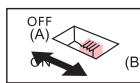

Smoke unit On/Off Switch

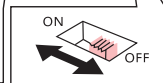

Main Power Switch

Airsoft version only includes:

BB bullet

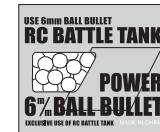

Target

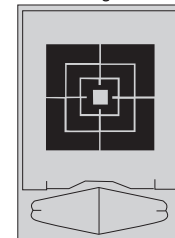

Protective cap

(Make sure the cap is always set on the muzzle except when shooting.)

ACCESSORY BOX



+ 435 435 00112
+ 421 421 00112
+ + 121 23345
+ + 121 121 23345

Decals

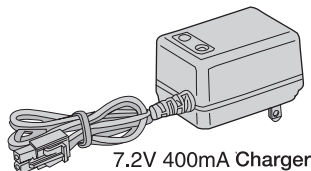

7.2V 400mA Charger



BATTERY PACK-CHARGING - WARNING AND SAFETY NOTES

- Make sure voltage and plug of charger correspond to local standards.
- Battery pack will become warm when charged excessively. In this case the charging has to be stopped or the battery might sustain damage.
- Do not leave charging unattended.
- Battery pack and charger are matched for safety reasons. Do not use other devices. This might cause explosions!
- Depending on how long the tank is operated, battery pack may become very hot. Allow battery to cool down for at least 30 minutes before charging it in order to prevent damage.
- Do not throw battery pack into open fire: explosion hazard!

CHARGING OF BATTERY PACK

To charge the battery pack, follow steps 1 - 5 .

- 1** Connect battery pack to charger.
- 2** Plug charger into power outlet.
- 3** The charging is finished after approximately 3-4 hours.
- 4** Disconnect charger from power source and disconnect battery from charger.
- 5** Connect battery to tank (see page 10).

Ni-MH-BATTERY

- Nickel-Metal Hydride batteries do not contain toxic heavy metals (unlike Nickel-Cadmium (Ni-Cd battery))
- Very powerful, durable, and reliable
- No "memory effect": no loss of capacitance due to incomplete charging

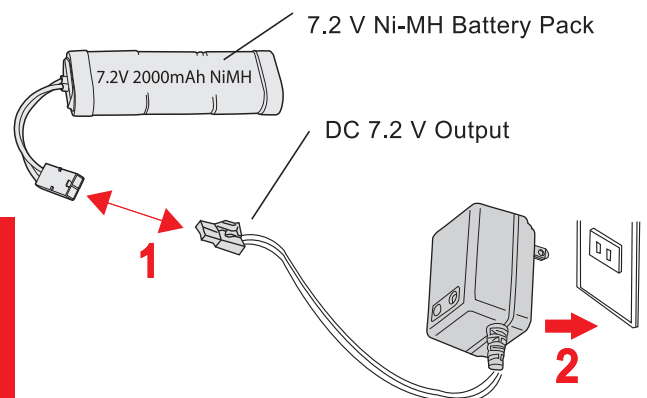

The tank will drive for around 15-25 minutes, depending on driving manner.



Caution

Do not cover battery pack during charging process and always keep battery away from flammable materials.

INSERTING BATTERIES (TANK + REMOTE CONTROL)

SWITCHES + ADJUSTMENTS

Switches and adjustments for

- On/Off
- Smoke Function
- Volume Sound

are on the bottom of the tank

Adjusting sound



Main power switch

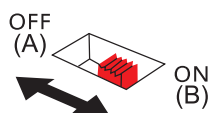
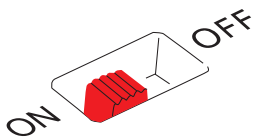

Smoking switch

BATTERY (TANK)



1. Locate upper hull release switch. Press towards the rear of the hull to release the latch.



2. Lift the rear of the upper hull and slide backwards. This will release the upper hull from the lower hull and allow access to the inside of the tank.



3. Insert battery in battery compartment and connect power wires.



4. To install top hull back on the tank, line the upper hull lip to the lower hull.



5. Make sure the front hull lip stays in position as you press down on the rear hull to lock in place.

Make note of where the wires were before removal. A wiring diagram can also be found at the end of the manual.

*Note: 75mm and 76mm Sherman tanks open and close the same, 75mm shown in some pictures.



Warning

Not inserting batteries with the correct polarity may cause battery leakage or device malfunction.



Warning

Do not let hands or fingers touch the ends of batteries.

Do not use different types of batteries together. This may result in battery leakage and/or burn injuries.

INSERTING BATTERIES (CONTROLLER)



① Set power switch to OFF position

② Press down on PUSH-imprint of battery case cover and slide open cover.

③ Insert batteries into battery case and observe correct polarity.

④ Slide cover back onto remote control and let it snap into lock.



6 X 1.5V AA batteries

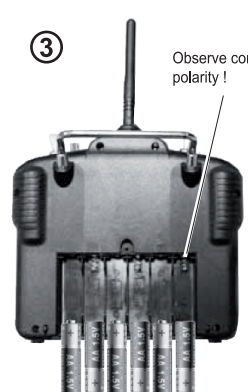

REMOTE CONTROL - FUNCTIONS + STEERING THE TANK

REMOTE CONTROL RANGE

Up to 260 ft. - depending on the terrain given

ON/OFF SEQUENCE FOR DEVICES

- When turning on power, turn on remote control first then the tank. Sequence for turning off power is vice versa.

CODE-BINDING

- **Code-Binding** has been performed ex factory. For further information on binding and on pin slot configuration on the printed circuit board (PCB) please refer to page 20.

REMOTE CONTROL - BINDING + FUNCTIONS

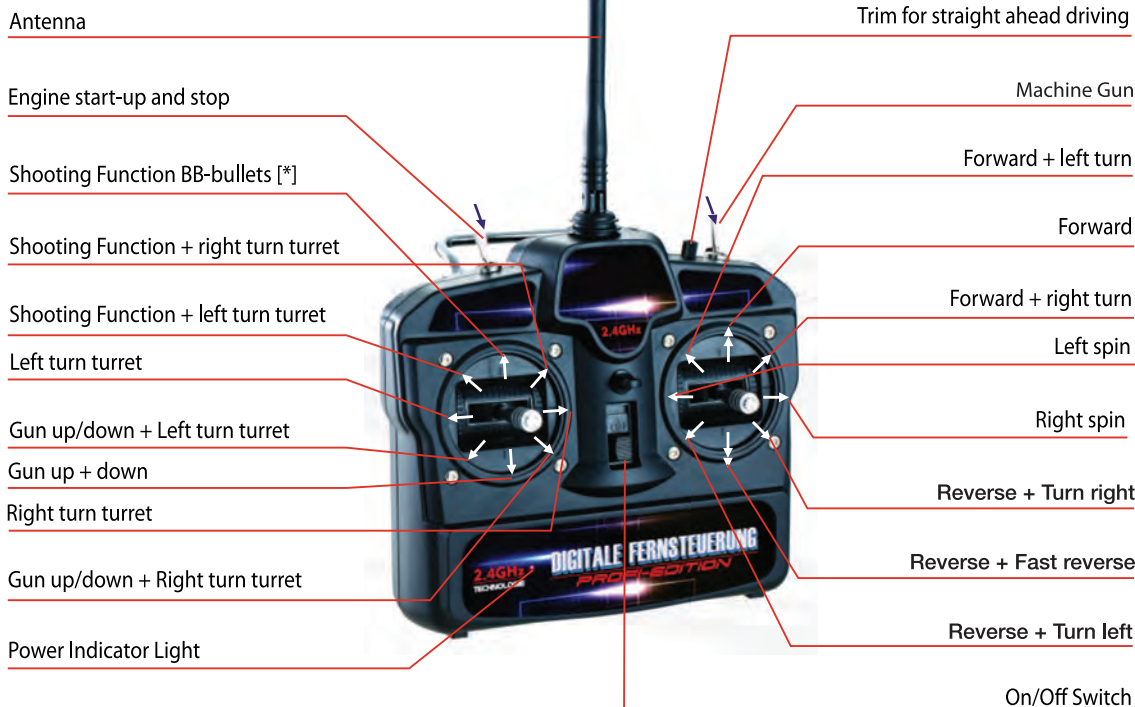

Caution

- Do not try to operate the control sticks if the tank is on a surface which creates excessive resistance or when the tracks get loose or entangled with something. Otherwise, the chassis or the motor might become damaged.
- Should a track come loose, any forced movement might cause it to break. Roll track onto wheels properly before you continue to operate the tank.
- If the gun hits objects or obstacles while moving, the gun barrel might become bent, thus making it impossible to shoot bullets.

STEERING THE TANK

This tank features proportional drive speeds. This means the tank will respond in proportion to the amount of throttle applied.

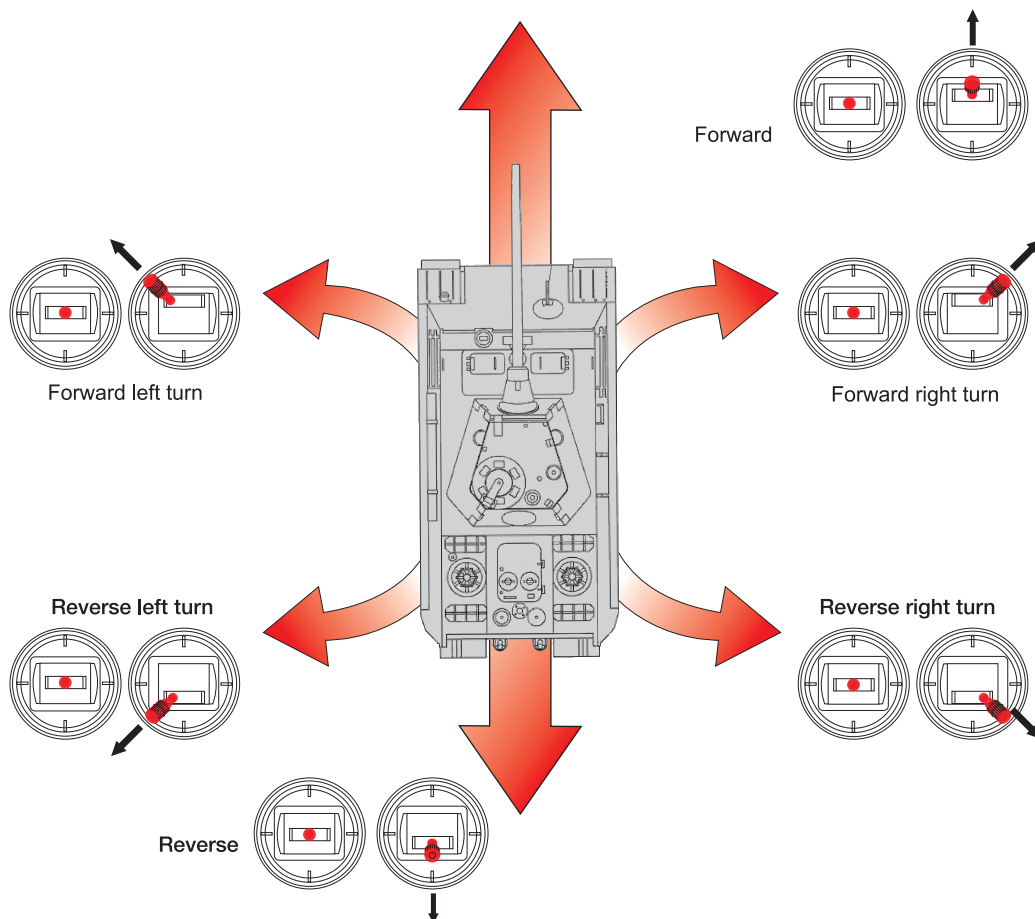

Warning



Engine and stop start-up
When headlights flash, tank cannot be operated.
When headlight stays on permanently, tank is operational.

START-UP DEVICES, VARIOUS FUNCTIONS AND SETTINGS

1. Turn the remote control on first, then turn the tank on by turning the tank upside down and flipping the main power switch to "ON." Next use the left toggle switch to start the tank by flipping it towards yourself. The tank will start up and the headlights will go solid indicating the tank is ready to drive. After around 30-60 seconds the tank will start emitting exhaust smoke. You can control the function of the smoke unit by flipping the red switch on the bottom of the tank to the "ON" or "Off" position.

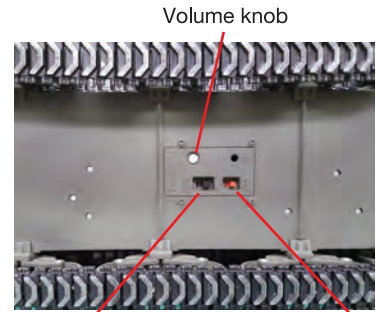

Volume knob
Main power switch
Smoke unit On/Off switch

2. While the tank is running, you can use the right toggle switch to toggle machine gun sounds. To fire the main cannon use the left joystick and press up. The tank will either fire an airsoft bullet or fire an infrared shot with flash. The tank will make a firing sound and the whole tank will recoil. The infrared version will also have the added bonus of barrel recoil as well. The user may adjust the sounds with the volume knob in the above photo.



MG-Firing Sound

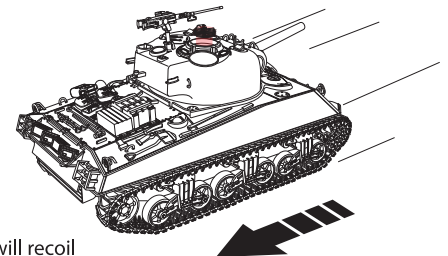
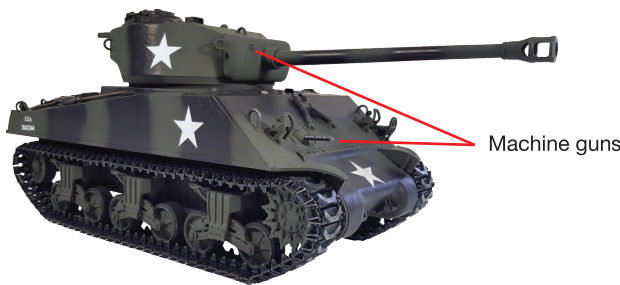

The tank will recoil backwards when firing in both airsoft and infrared edition tanks.

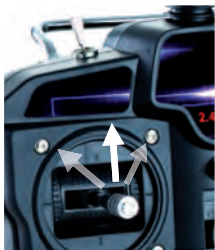

Shooting Function BB-bullets

LEFT/RIGHT TRIM

Special Notes on trim: The left/right trim is used when the tank moves left or right with the right control stick being in neutral position. This can be counteracted by converse trim action: If tank moves left, turn knob indicated has to be turned right vice versa.

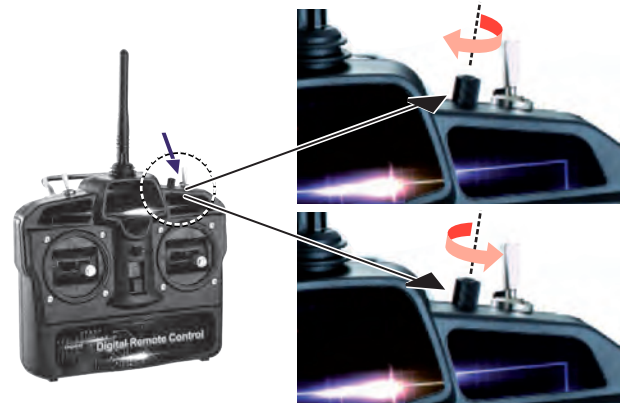

HOW TO PERFORM A SUPER SPIN

What is "Super Spin"? Both tracks run in the opposite direction enabling the tank to turn around itself.

Left Super Spin

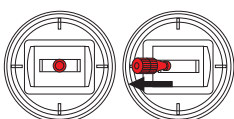

Move the right stick to the far left

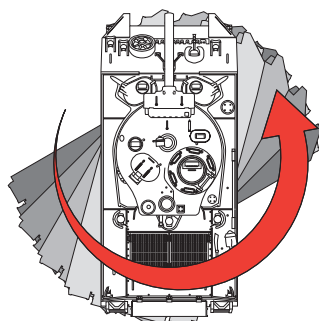

Right Super Spin

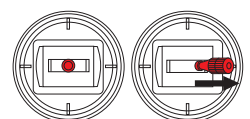

Move the right stick to the far right

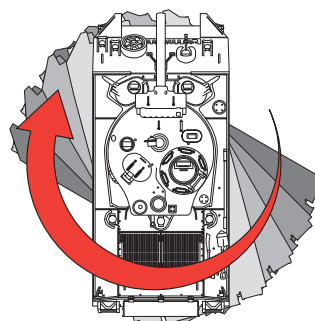

CONTROLLING TURRET + GUN

Warning

If the signals sent from the remote control are interfered with by other radio signals or if they are too weak this may lead to malfunctions including the accidental firing of BB-bullets. Should this occur, immediately set all functions (including the fire function!) of the tank to zero.

Turret Left Turn

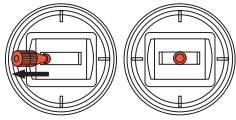

Push the left stick to the far left

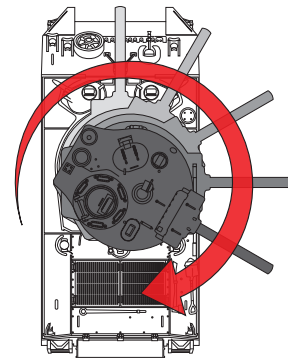
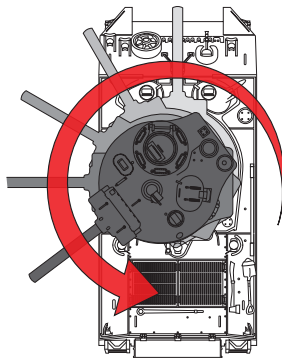

Turret Right Turn

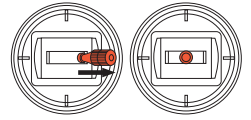

Push the left stick to the far right

The safety clutch is activated when the turret reaches its maximum turn to the left or right.

Gun Up/Down

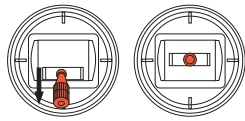

Press the left control stick down for continuous gun barrel elevation

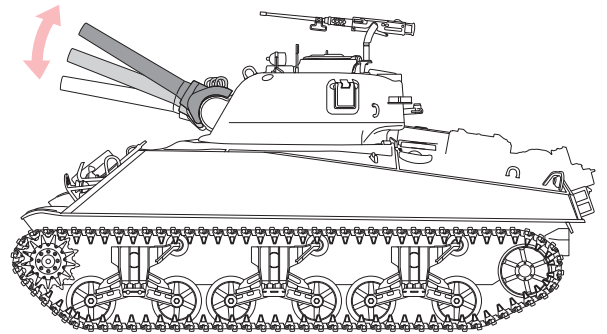

If the control stick is kept pushed down, the gun will continue to move up and down without interruption.

Caution

The maximum shooting range of the gun is 25 m. This may vary according to actual shooting conditions, such as the vertical angle of the gun and wind speed.

Firing BB-Bullets (NOT VALID FOR INFRARED VERSION)

Caution

To prepare for shooting, load in BB bullets as shown on p. 14, turn on the shooting switch and remove protective cap.

Shooting with the protective cap on the gun muzzle may cause damage to the firing mechanism.

※ The BB shooting indicator will light up right before the bullet is shot out.

Caution

The cannon will not fire if the safety switch is on. You can find this switch inside the top hatch of the turret.

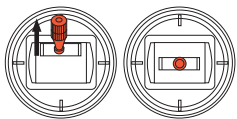

Press the left control stick up to fire

Keeping the control stick pushed up results in continuous fire.

Warning

- The shooting function may be used in safe environments only.
- People within the gun's shooting range are to wear safety goggles.
- It can happen for a bullet to remain inside the gun or the tank without this being realized. This may lead to potentially dangerous situations. Ensure that you are aware of the loading status of the tank and the gun.
- After use of the tank, put the protective cap onto the gun muzzle, turn off the tank's main switch and its shooting function, remove all BB bullets and batteries, and store everything in a safe place.

Caution

When firing the BB bullets, make sure that the turret is leveled.

TIP:

Operations can be combined to simulate actual tank moves. The following are examples of some types:

- Tank Forward + Turret Rotation
- Turret Rotation + Gun Elevation
- Shooting While Driving
- Superspin + Turret Rotation

Note

Combining functions consumes more battery power than using single functions separately.

HOW TO LOAD BB BULLETS (NOT FOR INFRARED VERSION)

Caution

Once fired, a BB bullet becomes dirty and is no longer suitable for re-use.



- If BB bullets covered with dirt or sand are used, jamming might occur and the loading mechanism might be damaged.
- Improper loading of bullets may lead to malfunctions.
- Bullets which weigh over 0,2 g will not reach the shooting distances specified in this manual.

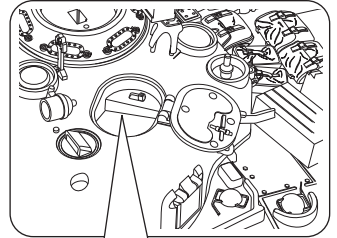
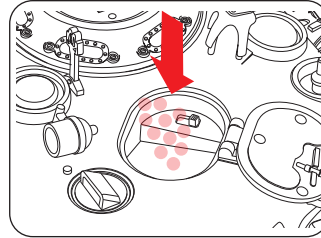
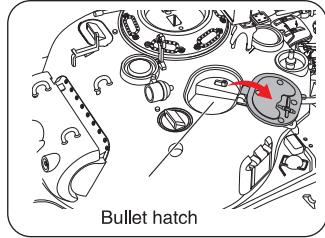

Use of the following bad bullets may lead to internal damages.

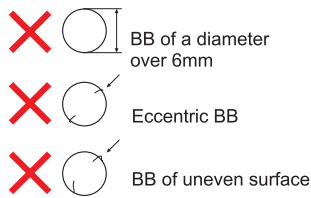

Set the shooting switch to ON.

The shooting switch (safety device) is normally kept OFF. Only for shooting can it be set ON.

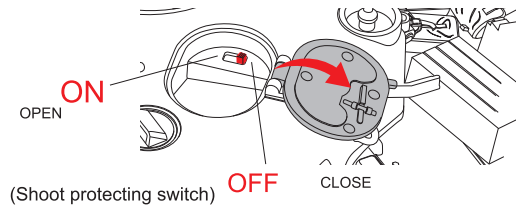

*The 75mm hatch is shown for loading BB's here. The 76mm Sherman will have the BB's loaded in the same place, but in the splitch hatch in its place.

Caution

- If dirt, dust or sand gets into the bullet container, the loading of the bullets might be disturbed, making shooting difficult or even impossible. In such event, turn the tank upside down so that the opened bullet hatch shows down. Slightly shake the tank to allow the dirt, sand or dust to fall out. If necessary, the cover of the turret may be taken off to blow into the opening in order to clean the bullet container from dirt, sand or dust. Do not re-load tank before having cleaned the bullet container from dirt or other foreign particles or objects.

HOP UP-SYSTEM

■ As illustrated, flying distance becomes much longer.

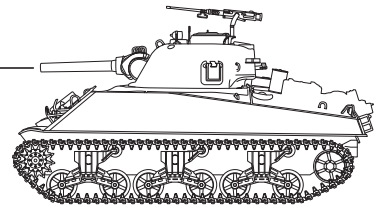
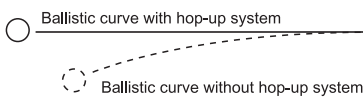

The RC tank is equipped with a hop-up system which induces a backspin of the bullet resulting in an upward motion, thus leading to a greater flying distance.

TARGET SET UP

- Enjoy shooting even more by using the target provided.

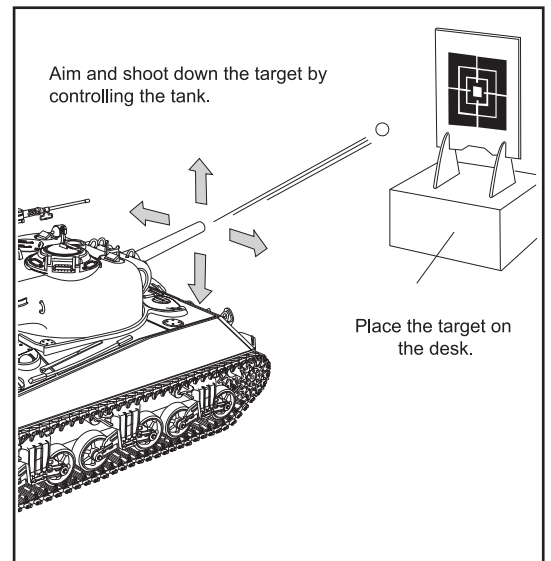
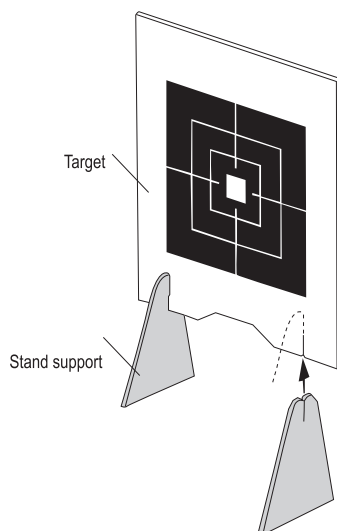

Tip: Aim at the bull's eye from the back of the tank before shooting. Lock onto target and fire.

- Firmly insert target into indentations of stand supports.



Caution

Infrared battle function: The maximum shooting range of the tank is 15m, which may differ according to actual shooting conditions, such as vertical angle of the gun and orientation.

Barrel recoil and flash (infrared only)

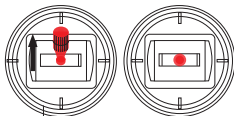

Press up on the left control stick to fire

Infrared battle function(Optional)

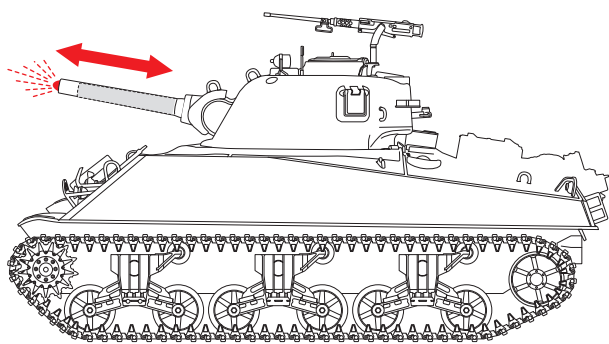

Caution

Turret should stay horizontal when shooting.

According to the design of the turret, if the left side or the back side of the turret is lower than their counter sides, bullets can not be loaded and shooting becomes impossible.

Because the infrared battle signals vulnerable to interference by external intense light, the operation should be chosen a place where without the glare light, so as to avoid influence the infrared battle effect.

Infrared battle function(Optional):

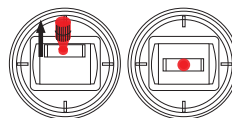

Installation of infrared receiver

Caution: The infrared receiver is keyed and can only be installed one way.

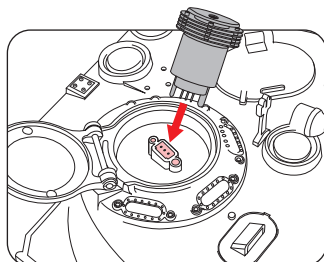

Push up the infrared battle lever.

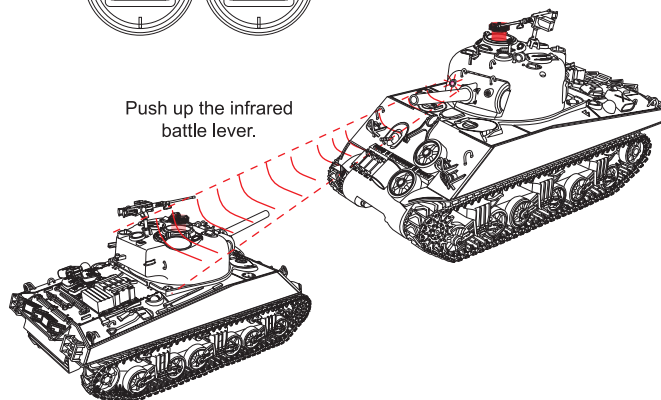

With two or more tanks you can have an infrared battle. The more tanks, the more intense the battle situation becomes! Use your leadership to conflict with the enemy in battle and become the battlefield overlord.

When the tank is hit by another, the first 1 to 4 times the tank will jerk from side to side and make a noise indicating a hit. You must wait 3 seconds before you can fire

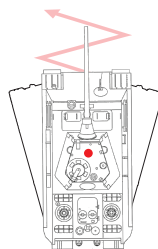

When the tank is hit for the fifth time, the tank will jerk back and forth and then will shut down. The LED headlights will be blinking indicating you have been defeated. To restart your tank, use the left toggle switch to start your tank as usual.

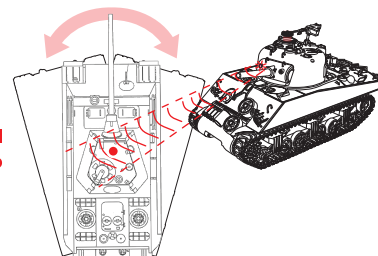

Suggestion: Operations can be combined to simulate actual tank moves.

Examples Run + Turret Turn + Gun Up/Down = The tank runs with turret turning and gun moving up and down.

Run + Turret Turn + BB Shoot/infrared battle = The tank runs with turret turning and gun shooting BB bullets/infrared battle while change the direction.

Turn + Turret Turn + BB Shoot/infrared battle = The tank turns with turret turning and gun shooting BB bullets/infrared battle while change the direction.



Caution

Combinations consume more battery power.

OPERATING INSTRUCTIONS ABOUT SMOKE UNIT

At the factory a small amount of smoke oil is left in the smoke unit chamber. You will have to add **2-3 DROPS** of smoke fluid when using the smoke function for the first time. These **2-3 DROPS** will last for around 2 hours of operation. When you notice a singed smell, this indicates the smoke oil is running low. Add smoke fluid to avoid malfunction of the smoke unit. Add **2-3 DROPS** only, more may damage your smoke unit. (Replacement part TAG120613)



Caution

To add smoke fluid first open the top hull. Then remove the black rubber cap on the smoke unit and add a few drops of fluid. Be careful not to overfill the unit or it can malfunction or spill! After filling, replace black rubber cap onto smoke unit and attach upper hull.

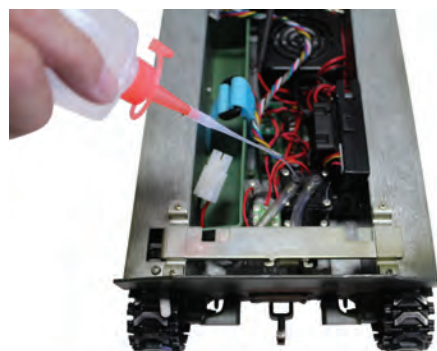

HOW TO INSTALL ACCESSORIES

ACCESSORY BOX

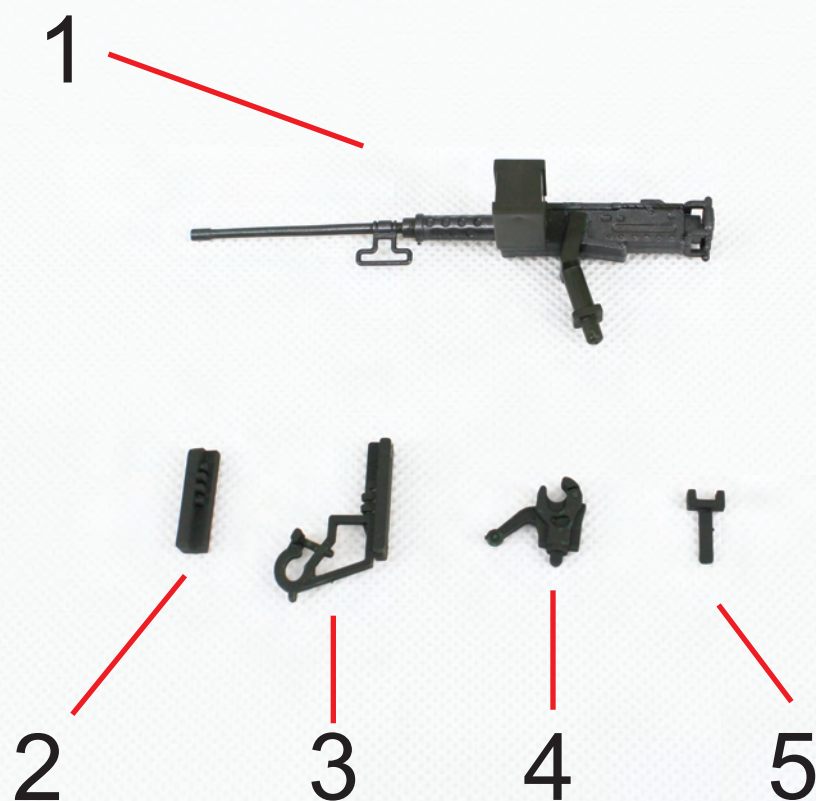

These parts must be installed manually. If the hole is too loose try adding a filler or extra glue. If the hole is too small then bore out the hole or accessory a tiny bit.

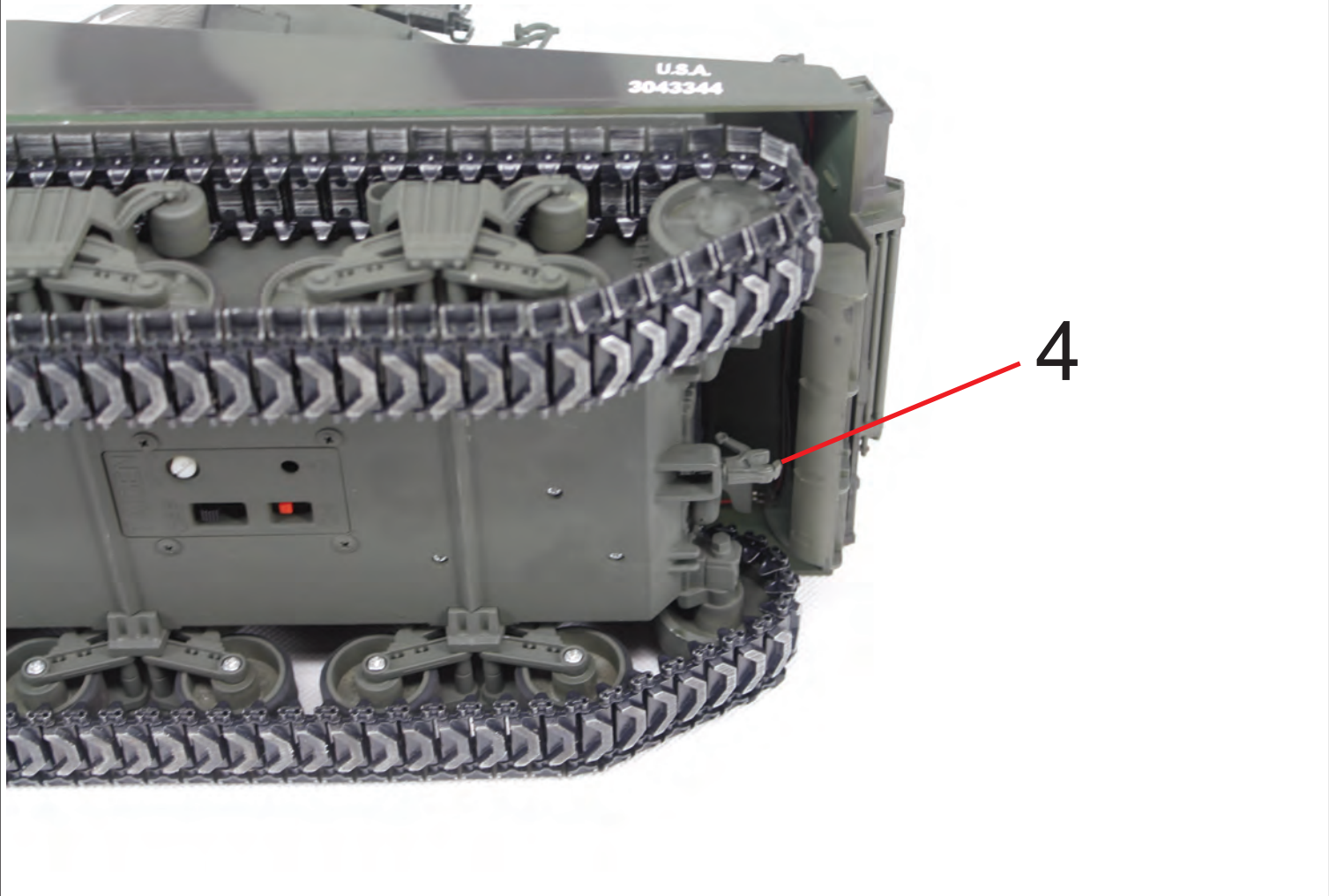
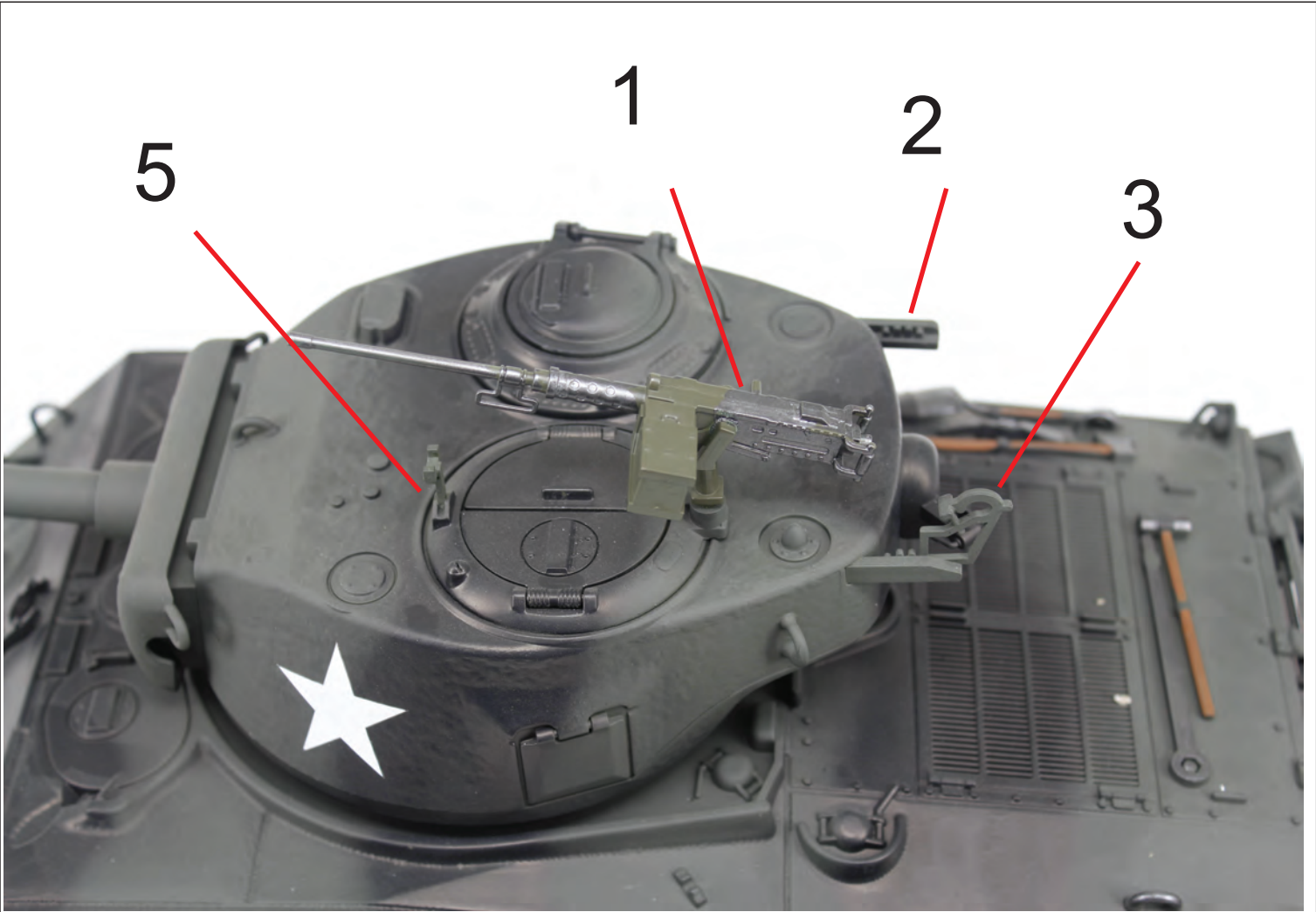

How to apply transfer decals

1. Cut a section around the decal to be placed

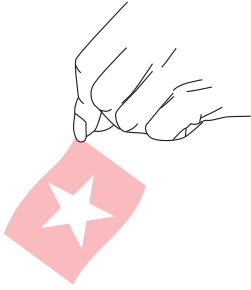

2. Press the decal on the tank and press decal firmly against the tank. Make sure to rub the edges of the decal.

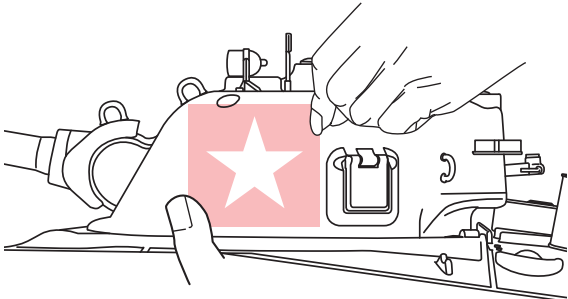

3. After 15 minutes you may pull off the transparent plastic that protects the decal off. **Do it slowly.**

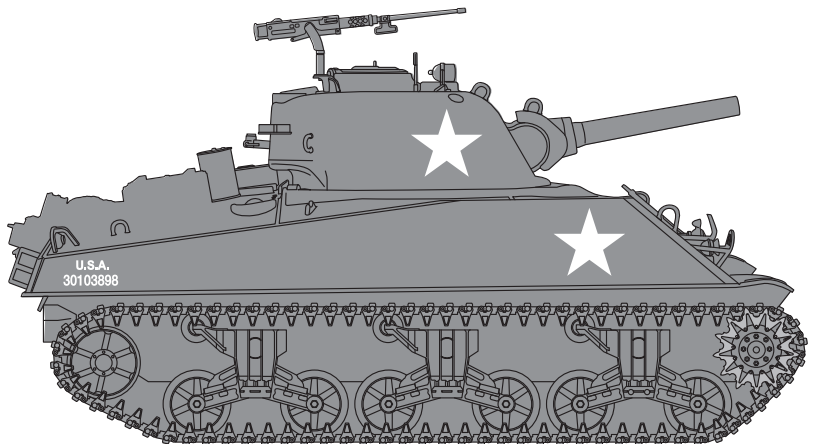
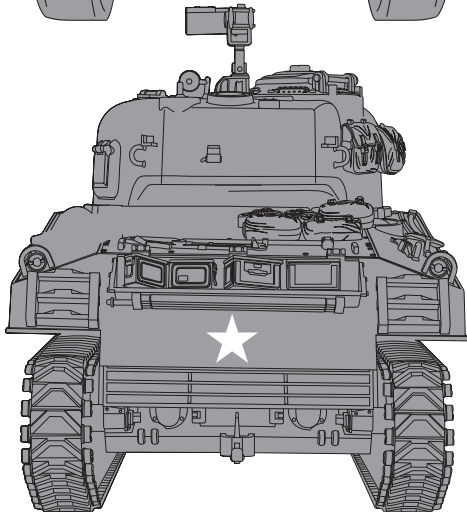
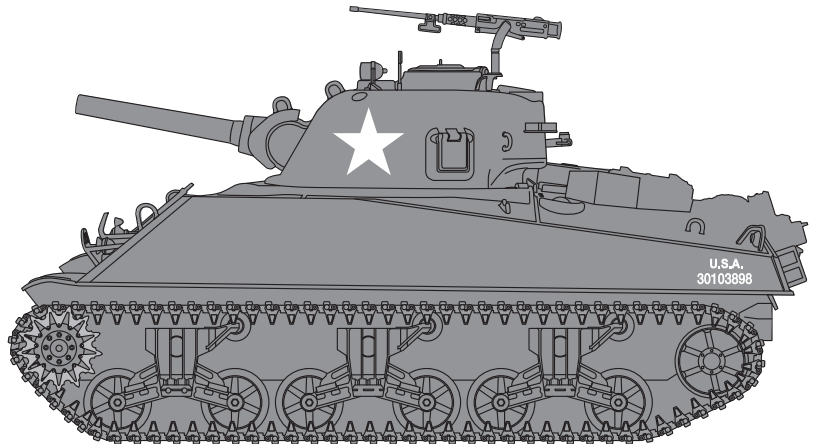
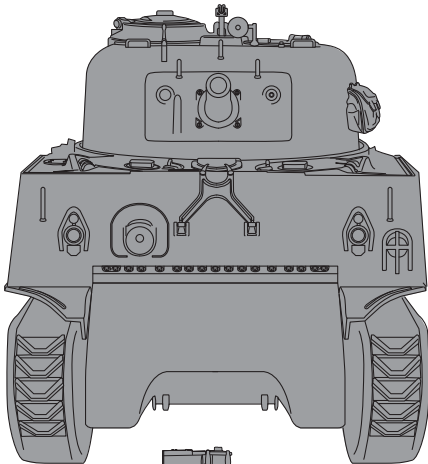
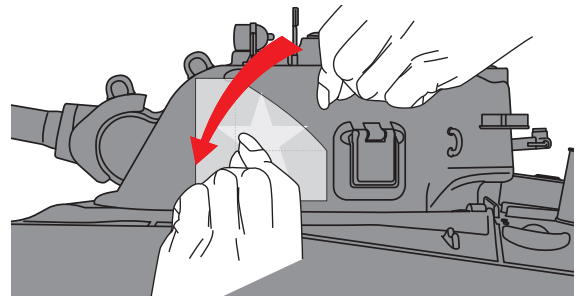

MAINTENANCE AND CARE



If drive sprockets or idler wheels make a grinding noise, they have to be carefully greased with a lubricant. This will enhance the service life of the tank.

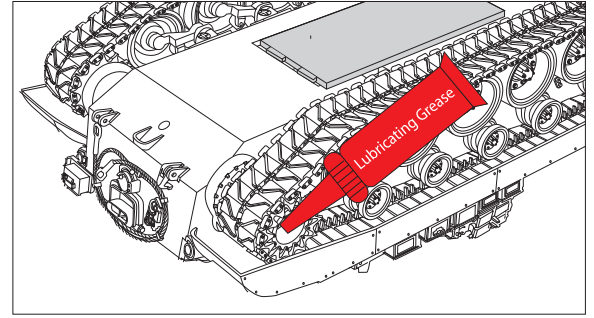

WARRANTY EXCLUSION

There is an exclusion of warranty for damages caused for any of the following reasons.



1 Accidentally letting the tank drop or exposing it to strong shocks which leads to the tank or remote control being damaged.



2 Tank or remote control are exposed to a wet environment leading to malfunctions.



3 The tank is driven in a place with too much sand, mud, dirt, or on an uneven surface, which leads to malfunctions or damage.



4 Tank is driven on carpets, lawns, or other surfaces which cause excessive resistance leading to damages.



5 Objects other than the specified BB-bullets are being used leading to jamming.

Airsoft versions only



6 Dirty or used BB bullets are used leading to damages.

BB bullets that have been used may have dirt on them and must not be used again to avoid damages.

- 7 Other malfunctions caused by noncompliance with warning or caution notices listed in this manual.
- 8 Malfunctions due to misuse (wrong battery polarity, wet conditions, shocks).
- 9 Malfunctions due to improper assembly, or alteration, or use of improper parts.
- 10 Malfunctions caused during transport, by dropping tank or remote control, or because of poor storing conditions.
- 11 Malfunctions caused by use of improper batteries. Chassis or motor damages caused by driving on surfaces which create excessive resistance.
- 12 Other malfunctions or damages not covered by our quality guarantee.

Airsoft versions only

No repair services will be offered for products, which have been altered or disassembled by the user in any way !

TAIGEN SPARE PARTS AND SUPPLEMENTARY EQUIPMENT

TAIGEN offers an excellent spare part service. Please contact your local dealer for spare parts inquiries.



TAIGEN TANKS



WARNING !

CHOKING HAZARD - SMALL PARTS ! KEEP AWAY FROM INFANTS, SMALL CHILDREN AND CHILDREN.



M4A3 SHERMAN 76MM 1/16TH 2.4GHZ MEDIUM TANK

Airbrushed Camo Paint Scheme
2.4GHz Radio System (Transmitter + Receiver)
Realistic Sounds With Adjustable Volume
Track Recoil
Barrel Recoil (Infrared Only)
All Metal Lower Chassis
Metal Caterpillar Tracks
Metal Drive Wheels
Metal Idler Wheels
Metal Road Wheels With Bearings & Rubber Tires
Metal VVSS Suspension
Metal Turret With 360 Degree Rotation
Metal Gun Barrel
Metal Gun Muzzle
Metal Turret Hatches
Steel 3:1 Gearboxes (Upgraded Ball Bearing Available)
2000mAh NIMH Battery & Charger
Internal Dedicated Battery Compartment
Easy Open Latch For Easy Access
Tank Decals and Accessories Included
Smoke Unit
11.75lbs With Battery
18.75" Long x 6.5" Wide x 6.5" Tall (Approximate)



TAIGEN TANKS

Manual 2.4 GHz Digital Remote Control

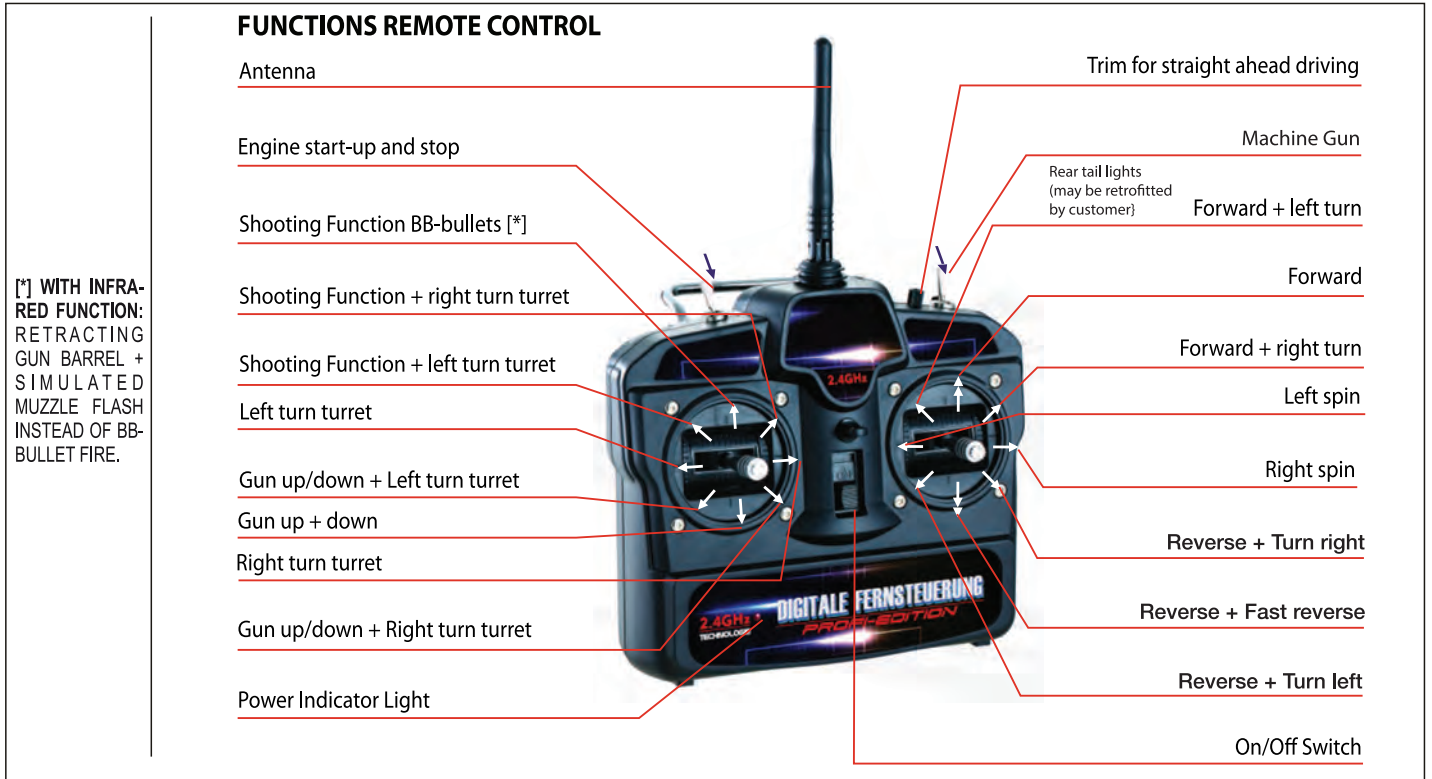

Code binding has been performed at the factory already for you. If needed you may re-bind using this sequence:

1. Press machine gun toggle switch towards yourself.
2. Turn on transmitter and then the tank shortly afterwards.
3. Press the right toggle switch (machine gun) away from you.
4. Use the left toggle switch (ignition) to start your tank.

After having performed steps 1 and 2 the power LED indicator will flash for approximately 6 seconds. When the light goes solid the binding is finished. Press the machine gun toggle back away from you before starting the tank.

Remote Control: When the battery level is low, the power indicator will start to flash, this is indication that you must replace the batteries.

Machine Gun toggle: When toggle is set to front (towards you) the machine gun sound is activated. When set to rear (away from you) the machine gun sound is deactivated.

Ignition toggle: When toggle is set to front (towards you) the tank will start. When toggle is set to rear (away from you) the tank will go into a standby mode and blink headlights.

