

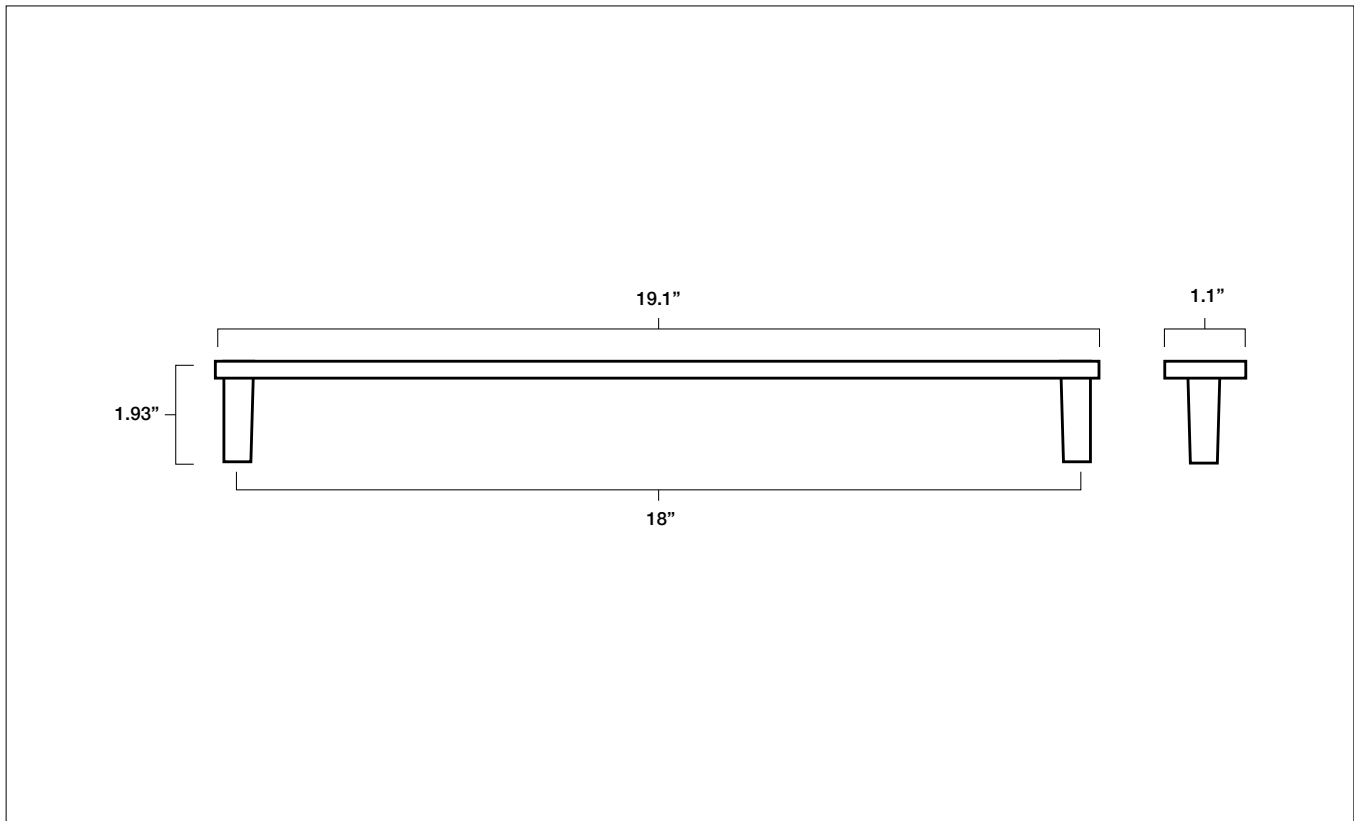

HORIZON 18" APPLIANCE PULL

Tech Spec



FINISH	SKU	ALSO INCLUDED
Matte Black Polished Nickel Satin Brass Satin Nickel	H1026-MB H1026-PN H1026-SB H1026-SN	(2) 1/4" -20, 1.25" Phillips head screws (2) 1/4" -20, 1.75" Phillips head screws

CARE INSTRUCTIONS:

Gentle is key. Clean your hardware with a soft, damp cloth, and wipe completely dry. Do not leave any water or soap residue on your product. Never use any chemicals or harsh over-the-counter cleaners, as these will strip the finish and void your warranty.