



ALTITUDE

Riders:
Thomas Vanderham

Photo:
Margus Riga

Location:
North Shore, BC

-ENG-FR-GER-IT

REGISTER / ENREGISTRER / REGISTRA / REGISTRIERE

Registering your bike is the official way for us to welcome you into the Rocky Mountain family. It's also an important step in activating your bike's warranty. If you ever have an issue, we'll be able to handle your case efficiently and get you back riding as soon as possible. It's easy and only takes a few minutes.

Register your bike: bikes.com/register

L'enregistrement de votre vélo marque votre entrée officielle dans la famille Rocky Mountain, et c'est une étape importante pour en activer la garantie. Ainsi, en cas de problème, nous pourrions le régler efficacement pour vous faire remonter en selle aussitôt que possible. L'enregistrement est facile et ne prend que quelques minutes.

Enregistrer votre vélo : bikes.com/register

La procedura di registrazione della tua bicicletta è il modo ufficiale di accoglierti nella famiglia Rocky Mountain. È inoltre una tappa importante per attivare la garanzia della tua bicicletta. Nel caso in cui si verificasse un problema, potremo gestire il tuo caso in maniera efficiente e farti risalire in sella il più presto possibile. La procedura di registrazione è semplice e richiede solo alcuni minuti.

Registra la tua bicicletta: bikes.com/register

Wenn du dein Bike registrierst, können wir dich offiziell in der Rocky Mountain Familie willkommen heißen. Es ist auch ein wichtiger Schritt für die Aktivierung der Garantie deines Bikes. Solltest du irgendwann ein Problem haben, können wir deinen Fall effizient bearbeiten und dich schnellstmöglich wieder auf dein Bike bringen. Es ist einfach und dauert nur ein paar Minuten.

Registrierte dein Bike: bikes.com/register



TABLE OF CONTENTS

Introduction	4	Introduction	40
Shrediquette	4	Étiquette de montagne	40
Getting to know your bike	5	Survol de votre vélo	41
Geometry & sizing	7	Géométrie et tailles	43
Specifications & Dimensions	13	Spécifications et dimensions	49
Shock Bearing Eyelet & Hardware	17	Quincaillerie	56
Suspension Setup	21	Configuration de la suspension	57
Cable routing	26	Passage des câbles	62
Critical Dimensions	31	Guide des dimensions	67
Warranty information	38	Garantie	74
Einleitung	76	Introduction	112
Etikette de la montagne	76	Shrediquette	112
Lerne dein bike kennen	77	Caratteristiche de la bicicletta	113
Geometrie und grössen	79	Geometria E Dimensioni	115
Spezifikationen und abmessungen	85	Specifiche E Dimensioni	126
Hardware für Dämpfer	91	Configurazione Delle Sospensioni	129
Einrichtung Des Federungssystems	95	Passaggio dei cavi installazione del freno	134
Kabelführung	98	Dimensioni Critiche	140
Wichtige Abmessungen	103	Garanzia	146
Garantieinformationen	110		



INTRODUCTION

Unleash unparalleled confidence with the Altitude. From racing the clock to racing your friends on the weekend, this bike is purpose- built to go fast, demolish steep trails, and help you hold bigger lines. Its total enduro capabilities can not only help secure you podium finishes, but also help you to tackle more demanding and committing weekend adventures. With so much capability in your corner, it makes you want to push limits, climb faster, and get better.

This manual contains important safety, maintenance, and user information. Read and understand it thoroughly before your first ride on your new Rocky Mountain bicycle. This material applies only to the specific platform you have chosen and should be used in conjunction with your Rocky Mountain Owner's Manual, which is included with your bike. Please read the Owner's Manual before your first ride. If you do not have a copy of the Owner's Manual, you can get it from your nearest authorized Rocky Mountain dealer.

SHREDIQUETTE

Riders

Always be courteous to other trail users. Use extra caution around domestic animals, such as dogs and horses. Give other trail users right-of-way in all situations, during both climbing and descending.

Trails

Only ride your bicycle on trails and paths sanctioned for bicycle use. Follow all local laws and regulations. As for all trail users, care should be taken to avoid impacts on the trail or environment. Do not skid on or modify trails.



GETTING TO KNOW YOUR BIKE



TECHNICAL DETAILS

- The all-new Altitude features a complete redesign with the weight redistributed lower down, the frame stiffness increased, added adjustability for a more optimized rider fit, and several new technical features that further elevates this new design over previous generations.
- Revised LC2R kinematics features sensitivity paired with increased support throughout the travel, with a goal of reducing rider fatigue on long and rough Enduro stages.
- The SM frame is equipped with 27.5" front and rear wheels while the MD-LG-XL frames are equipped with 29" front and rear wheels. The MD-LG-XL frames can be setup with MX wheel setup (29 Front / 27.5 Rear) if desired without any additional frame parts required.
- The RIDE-4™ adjustment system allows riders to quickly fine-tune their geometry with a single Allen key.
- All frames are equipped with reach adjust headsets to fine tune the reach. Installed on the frame is a 0mm / neutral headset. In the small parts box added with every frameset and complete bicycle, there is an additional set of 5mm headset cups that can be used to make reach adjustments.
- Our new PenaltyBox 2.0 storage compartment features a water-resistant fit coupled with a stiff, dual latch design that is easy to operated. Don't miss the secret compartment to add a tracking device, such as a Tile or AirTag, to keep your bike safe.
- All frames accessory mounts under the top tube for additional storage needs. LG and XL frames can fit a 2nd 21oz water bottle in this location.
- Sealed bearings at the shock eyelet dramatically improve shock sensitivity (aftermarket shock compatible) while bearing shields throughout the frame help prevent contamination from gnarly trail conditions or post-ride wash stations.

GETTING TO KNOW YOUR BIKE



TECHNICAL DETAILS

- Our LC2R suspension features a bottom-bracket concentric main pivot with a stiff link design paired with durable, oversized bearings.
- All models include an integrated OneUp chain guide, with 2-bolt ISCG05 tabs for mounting a bashguard, keeping your chain on and your ring intact.
- The frames have extensive rubber protection to both reduce noise and prevent contact abrasion.
- All frame sizes are at minimum LG (21oz, 600ml) water bottle compatible.

GEOMETRY & SIZING

The Altitude is a size-specific frame design that features many details that improve the fit and geometry for each rider.

Wheel size

- The SM frame is equipped with 27.5" wheels front and back.
- The MD, LG, and XL frames are equipped with 29" wheels front and back, and they are also MX (Mullet) compatible.
- The MX adjustment is made by changing the position of the lower link shock mount chip.

Chip in 29 position

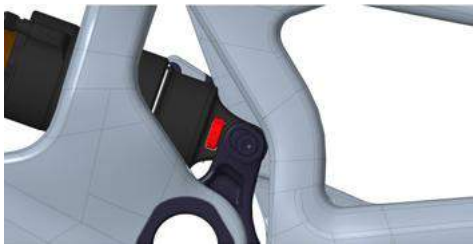

Chip in MX (27.5) position



Rear Center (sometime referred to as Chainstay length)

- The rear triangles are size specific, with the LG and XL sharing the same version. Please see the geometry chart for more details. The rear triangles on the MD, LG, and XL are interchangeable if one wishes to experiment with a different rear center lengths on the above frame sizes.

Reach-Adjust Headsets

- All frames are equipped with reach adjust headsets to fine tune the reach. Installed on the frame is a 0mm / neutral headset. In the small parts box added with every frameset and complete bicycle, there is an additional set of 5mm headset cups that can be used to make reach adjustments. When reviewing the geometry chart with the 5mm offset cups installed, simply add or subtract 5mm from the Reach, Top Tube Length, and Wheelbase measurements to match the orientation of the cups. For installation instructions, please see the Frame Features section.

Carbon hset 0mm



Carbon hset 5mm



Alloy hset 0mm



Alloy hset 5mm



GEOMETRY & SIZING

Ride-4

The RIDE-4™ adjustment system allows riders to quickly fine-tune their geometry with a single 6-mm Allen key. Four configurations are possible thanks to a pair of rotating chips. Please see the geometry chart for how each position affects the geometry. For adjustment instructions, please see the Frame Features section.

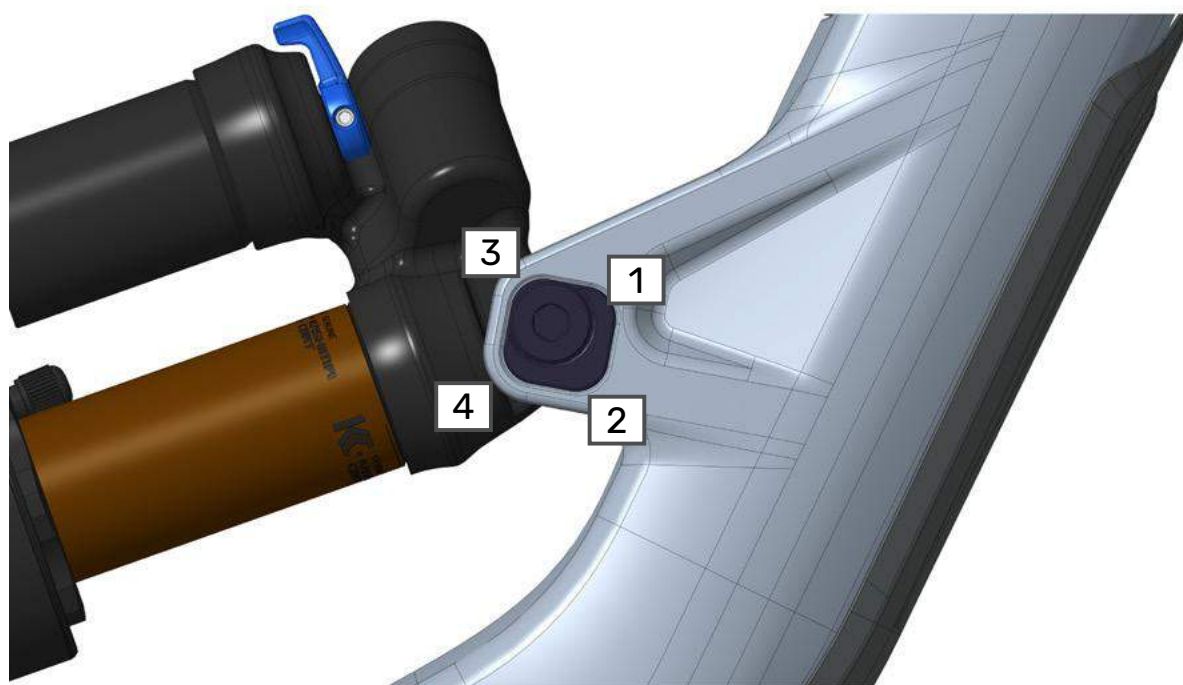

GEOMETRY & SIZING

Frame Sizing

This chart is a rough guide only. Rider proportions, riding style, and personal preferences all factor in choosing the correct bike size. Generally, shorter reach bikes tend to have a more dynamic, lively feel. Longer bikes tend to have a more stable, muted feel. Rocky Mountain always recommends test riding and professional bike fitting at an authorized dealer.

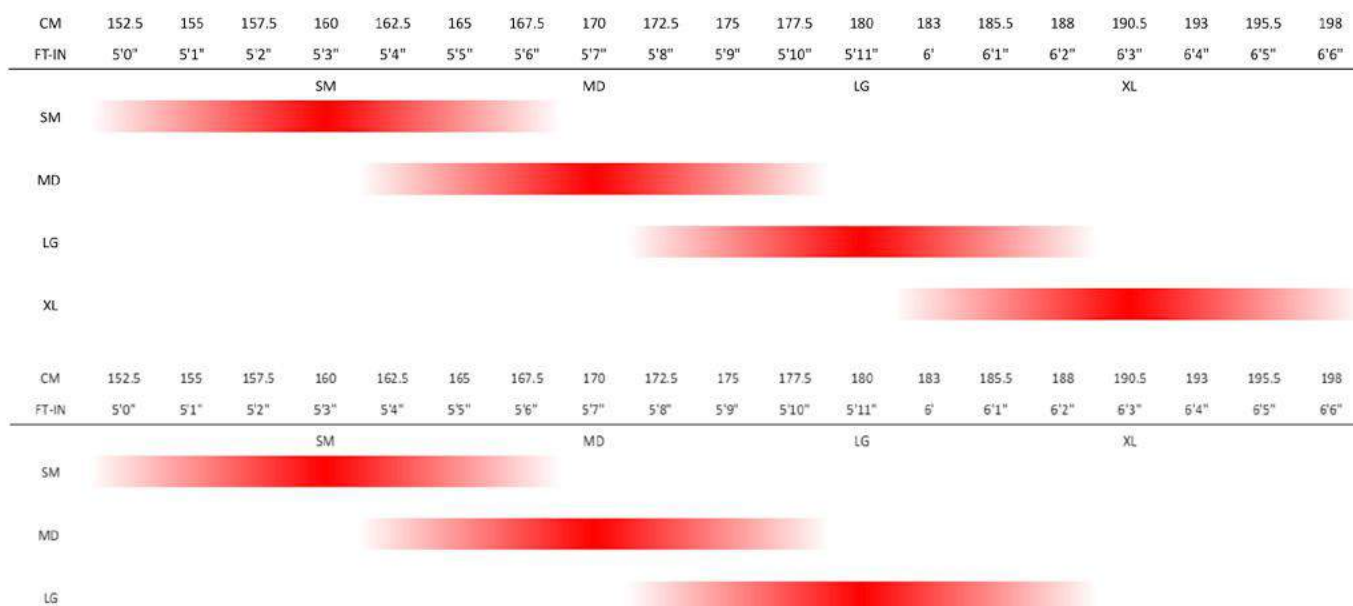

Geometry Chart

FRAME SIZE	SM	MD	LG	XL	MD	LG	XL
Wheel size	27.5		29			MX	
Head Tube Angle (deg)	63	63	63	63	62.9	62.9	62.9
Seat Tube Angle (deg)	77	77	77	77	77	77	77
Seat Tube Length (mm)	365	410	440	470	410	440	470
Top Tube Length (mm)	553	584	610	642	584	610	642
Head Tube Length (mm)	100	105	115	130	105	115	130
Rear Center (mm)	Position 1 Slack		430	440	450	450	450
Bottom Bracket Drop (mm)	24	38	38	38	29	29	29
Standover Height (mm)	760	792	798	809	791	797	808
Wheelbase (mm)	1189	1244	1283	1319	1243	1282	1319
Reach (mm)	424	450	475	505	450	475	505
Stack (mm)	599	630	639	653	630	639	653

GEOMETRY & SIZING

FRAME SIZE Wheel size		SM 27.5	MD	LG 29	XL	MD	LG MX	XL
Head Tube Angle (deg)		63,3	63,3	63,3	63,3	63,2	63,2	63,2
Seat Tube Angle (deg)		77,3	77,3	77,3	77,3	77,2	77,2	77,2
Seat Tube Length (mm)		365	410	440	470	410	440	470
Top Tube Length (mm)		553	584	610	642	584	610	642
Head Tube Length (mm)		100	105	115	130	105	115	130
Rear Center (mm)	Position 2	430	440	450	450	440	450	450
Bottom Bracket Drop (mm)		20	34	34	34	25	25	25
Standover Height (mm)		763	794	801	812	793	801	812
Wheelbase (mm)		1189	1243	1283	1319	1242	1282	1318
Reach (mm)		427	453	478	508	453	478	508
Stack (mm)		599	630	639	653	630	639	653
Head Tube Angle (deg)		63,5	63,5	63,5	63,5	63,4	63,4	63,4
Seat Tube Angle (deg)		77,5	77,5	77,5	77,5	77,4	77,4	77,4
Seat Tube Length (mm)		365	410	440	470	410	440	470
Top Tube Length (mm)		553	584	610	642	584	610	642
Head Tube Length (mm)		100	105	115	130	105	115	130
Rear Center (mm)	Position 3 Neutral	430	440	450	450	440	450	450
Bottom Bracket Drop (mm)		17	31	31	31	22	22	22
Standover Height (mm)		765	796	803	814	796	803	814
Wheelbase (mm)		1188	1243	1282	1319	1242	1281	1318
Reach (mm)		430	455	480	510	455	480	510
Stack (mm)		599	630	639	653	630	639	653
Head Tube Angle (deg)		63,8	63,8	63,8	63,8	63,7	63,7	63,7
Seat Tube Angle (deg)		77,8	77,8	77,8	77,8	77,7	77,7	77,7
Seat Tube Length (mm)		365	410	440	470	410	440	470
Top Tube Length (mm)		553	584	610	642	584	610	642
Head Tube Length (mm)		100	105	115	130	105	115	130
Rear Center (mm)	Position 4 Steep	430	440	450	450	440	450	450
Bottom Bracket Drop (mm)		13	27	27	27	18	18	18
Standover Height (mm)		768	798	806	817	798	806	817
Wheelbase (mm)		1188	1242	1282	1319	1241	1281	1317
Reach (mm)		433	458	483	513	458	483	513
Stack (mm)		599	630	640	653	630	639	653

GEOMETRY & SIZING

Dropper Seatpost Fitment

Dropper seatposts play an important role in bike fit and comfort. Below you will find the critical dimensions and measurements that will guide you in the OEM post configuration as well as some of the possible options if an aftermarket dropper seatpost is installed.

The chart shows seatpost fitment with the seatpost travel fully extended. This allows you to determine what the lowest or highest position your seatpost can be set at for the correct height in a seated pedalling position. The chart will also help guide you in determining the size seatpost to install if the OEM one isn't the desired size. Please note that the dimension listed is from the center of the BB to the top of the OEM saddle. Crankset length can influence the seated fit and should also be considered if that component is changed.

How to use the chart

1. Measure your current saddle height from the center of the bottom bracket to the top of the saddle right above the seatpost.
2. Choose your desired post model and amount of post travel/drop and frame.
3. Ensure that your measurement falls between the minimum and maximum saddle height listed in the chart.

Example: I measured 795mm on my current bike. If I choose a OneUp V3, 210mm travel option, on a LG Carbon frame, I can see that I can fit this combination of post travel and frame size as the minimum and maximum measurements possible are 735mm to 860mm.

POST MODEL	POST TRAVEL	FRAME SIZE	CARBON				ALLOY			
			SM	MD	LG	XL	SM	MD	LG	XL
		Seat Tube Length	365	410	440	470	365	410	440	470
		Minimum Insertion	100	100	100	100	100	100	100	100
		Maximum Insertion	212	260	290	320	192	240	270	300
X Fusion Manic	150	Minimum saddle height	661	658	685	715	681	678	685	715
	150	Maximum saddle height	735	780	810	840	735	780	810	840
	170	Minimum saddle height	705	702	705	735	725	722	722	735
	170	Maximum saddle height	749	794	824	854	749	794	824	854
	200	Minimum saddle height	770	767	767	767	790	787	787	787
	200	Maximum saddle height	794	839	869	899	794	839	869	899
	200	Minimum saddle height	732	737	737	766	772	747	777	807
	200	Minimum saddle height	794	839	869	899	794	839	869	899
2020- 2024 Race Face Turbine R	150	Minimum saddle height	644	643	673	703	664	661	673	703
	150	Maximum saddle height	728	773	803	833	728	773	803	833
	175	Minimum saddle height	701	698	698	728	721	718	718	728
	175	Maximum saddle height	785	830	860	890	785	830	860	890
Fox Transfer	200	Minimum saddle height	757	754	754	754	777	774	774	774
	200	Maximum saddle height	791	836	866	896	791	836	866	896
	200	Minimum saddle height	719	724	724	754	759	734	764	794
	200	Minimum saddle height	791	836	866	896	791	836	866	896

GEOMETRY & SIZING

POST MODEL	POST TRAVEL	FRAME SIZE	CARBON				ALLOY			
			SM	MD	LG	XL	SM	MD	LG	XL
Reverb AXS *min post insertion is 80mm, however frame requires 100mm	150	Minimum saddle height	661	670	700	730	681	678	700	730
	150	Maximum saddle height	750	795	825	855	750	795	825	855
	170	Minimum saddle height	701	698	720	750	721	718	720	750
	170	Maximum saddle height	790	835	865	895	790	835	865	895
OneUp V2 Dropper *Travel is adjustable and can be reduced up to 20mm, in 10mm increments	150	Minimum saddle height	618	638	668	698	638	638	668	698
	150	Maximum saddle height	725	770	800	830	725	770	800	830
	180	Minimum saddle height	678	675	698	728	698	695	698	728
	180	Maximum saddle height	755	800	830	860	755	800	830	860
	210	Minimum saddle height	738	735	735	758	758	755	755	758
	210	Maximum saddle height	785	830	860	890	785	830	860	890
	240	Minimum saddle height	808	805	805	805	828	825	825	825
	240	Maximum saddle height	815	860	890	920	815	860	890	920
BikeYoke Divine 3 *Travel is adjustable and can be reduced up to 30mm, travel option dependant, in 5mm increments	160	Minimum saddle height	649	652	682	712	669	666	682	712
	160	Maximum saddle height	740	785	815	845	740	785	815	845
	185	Minimum saddle height	699	696	707	737	719	716	716	737
	185	Maximum saddle height	790	835	865	895	790	835	865	895
	213	Minimum saddle height	764	761	761	765	784	781	781	781
	213	Maximum saddle height	825	870	900	930	825	870	900	930

SPECIFICATIONS AND DIMENSIONS

Frame features

Concentric Bottom Bracket Main Pivot

The new Altitude is equipped with a concentric bottom bracket main pivot that requires a special tool for assembly and disassembly. This tool (Item 59, Part Number 1804039) is provided with each frameset and complete bike in the small parts box to ensure that the owner can perform their own service or, if they are having someone else servicing their frame, provide the tool to their service center. The tool is marked with the correct installation torque value (25Nm) to ensure correct assembly.

Altitude Lower Link Exploded Diagram

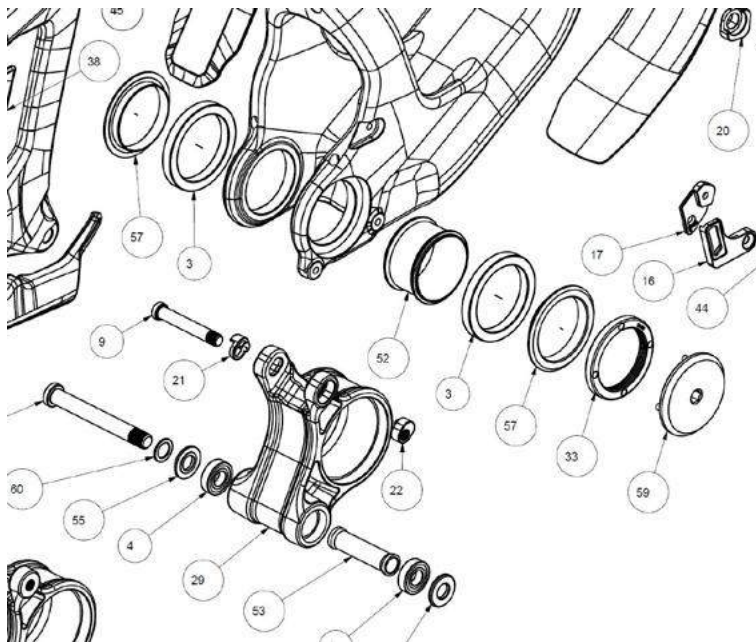

The main pivot is keyed into the frame to prevent rotation of the pivot during the assembly process. A small amount of rotational free-play is acceptable between the keyed interface of the main pivot axle and the frame. The pivot will be securely fitted once the lock nut is correctly fastened down.

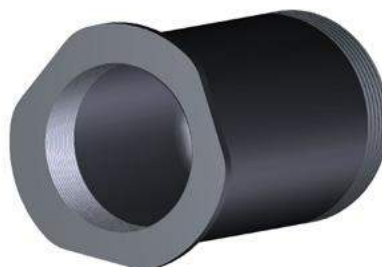

SPECIFICATIONS AND DIMENSIONS

Reach-Adjust Headset

All frames are equipped with reach adjust headsets to fine tune the reach. Installed on the frame is a 0mm / neutral headset. In the small parts box added with every frameset and complete bicycle, there is an additional set of 5mm headset cups that can be used to make reach adjustments.

The Carbon Altitude frame uses drop-in style, oval headset cups. No tools are required to remove and install the cups in the frame. Cup alignment is automatically achieved due to the keyed, oval shape of the cups and headtube. The cups feature an integrated o-ring around the outside of the cup to keep them secured in the frame and reduce movement that can lead to noise. The headsets for the carbon frames are manufactured by FSA and are the No.85-1 model. They use standard FSA assembly parts such as bearings and races to ensure that replacing wear items are a painless process.

The Alloy Altitude frame uses press-in style, oversized headset cups. Specialized headset installation tools are required to remove and install the cups in the frame. Cup alignment must be carefully managed to achieve proper alignment due to the non-keyed shape of the cups and headtube. The cups feature an alignment mark on the outside face to align them in the frame. Aligning a long straight edge ruler along this mark and the length of the top tube (upper cup) or downtube (lower cup) is the easiest way to ensure proper cup alignment. The headsets for the alloy frames are manufactured by FSA and are the HS-RM-01 model. They use standard FSA assembly parts such as bearings and races to ensure that replacing wear items are a painless process.

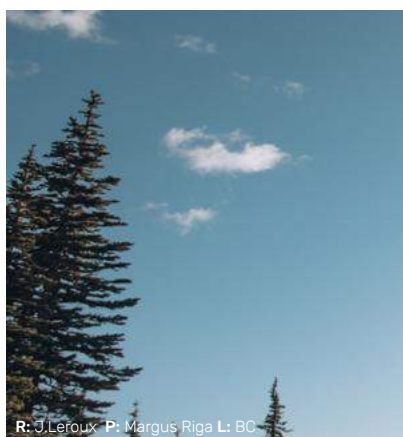

SPECIFICATIONS AND DIMENSIONS

Assembly Altitude Carbon Headset

ITEM NUMBER	QTY	ITEM	PART NUMBER	DESCRIPTION
N/A	N/A	Headset	14100078000013	FSA Part Number No.85-10mm Offset Headset, complete
N/A	N/A	Headset	1194001	RMB Part Number No.85-10mm Offset Headset, complete
9	1	Headset Cup Set	141-0079000011	FSA Part Number No.85-15mm Offset cups only
	1	Headset Cup Set	1194002	RMB Part Number No.85-15mm Offset cups inc. O-rings
1	1	Rubber O-Ring	160-7042	FSA Top Cap Inner Rubber O-Ring
2, 3	1	Top Cap	161-4430	FSA 5.3mm Top Cap inc. rubber seal
4	1	Split Race	160-7626	FSA 1 1/8" Headset Compression Ring
5	1	Bearing	160-6465	FSA Stainless ACB 1 1/8" 36°x45° Bearing
10	1	Bearing	160-67400E	FSA Stainless ACB 1.5" 36°x45° Bearing
11	1	Crown Race	160-5536	FSA 1.5" Crown Race

Assembly Altitude Alloy Headset

ITEM NUMBER	QTY	ITEM	PART NUMBER	DESCRIPTION
N/A	N/A	Headset	1194003	RMB ZS56 66 0mm Offset Headset, complete
6, 7	N/A	Headset Cup Set	1194004	RMB Upper ZS56 5mm Offset Cup Set
1	1	Rubber O-Ring	160-7042	Top Cap Inner Rubber O-Ring
2, 3	1	Top Cap	161-4430	FSA 5.3mm Top Cap inc. rubber seal
4	1	Split Race	160-7626	FSA 1 1/8" Headset Compression Ring
5	1	Bearing	160-6465	FSA Stainless ACB 1 1/8" 36°x45° Bearing
10	1	Bearing	160-67400E	FSA Stainless ACB 1.5" 36°x45° Bearing
11	1	Crown Race	160-5536	FSA 1.5" Crown Race

SPECIFICATIONS AND DIMENSIONS

Ride-4

The RIDE-4™ adjustment system allows riders to quickly fine-tune their geometry with a single hex key. Four configurations are possible thanks to a pair of rotating chips. Please see the geometry chart for how each position affects the geometry. For adjustment instructions, please see the Frame Features section.

READY FOR ANY TRAIL

The RIDE-4™ adjustment system allows you to quickly fine-tune your geometry and suspension with a single 5-mm Allen key.

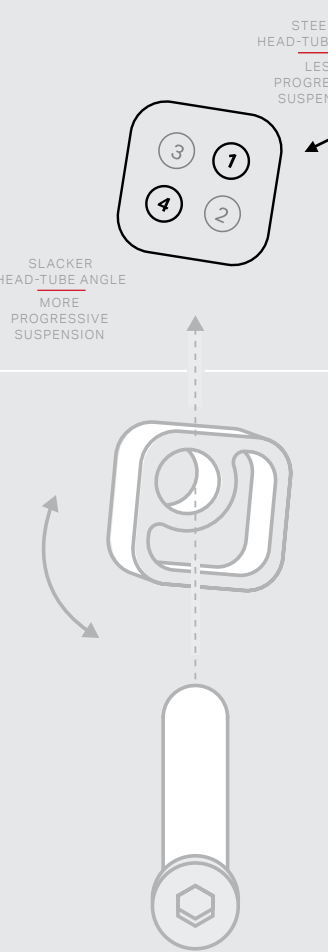

STEEPER HEAD-TUBE ANGLE
LESS PROGRESSIVE SUSPENSION

SLACKER HEAD-TUBE ANGLE
MORE PROGRESSIVE SUSPENSION



Position

 SLACK

The lower bottom bracket and progressive suspension increase stability at higher speeds. Recommended for more aggressive trail riding.

Position 3

 NEUTRAL

This position offers a balanced blend of geometry and suspension performance to cater to a wide variety of trails.

Position 4

 STEEP

The higher bottom bracket and linear suspension allow for better pedal clearance, a more supportive initial suspension rate, and a position on the bike better suited for climbing.

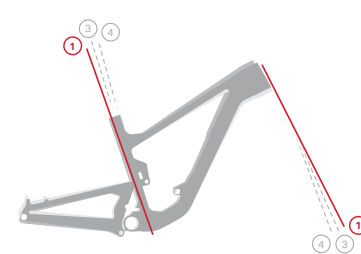

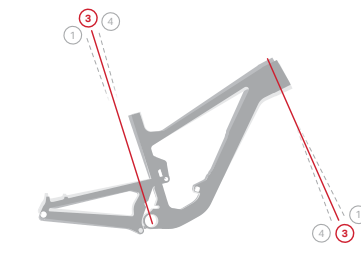

PENALTY BOX 2.0

The 2024 Altitude (Carbon Only) frame is equipped with the all-new Penalty Box 2.0 storage compartment, equipped with a tool wrap and tube bag. The cover features our innovative dual latch system that keeps the cover secure and rattle free. To open the compartment, simply pull lever on the outside and the cover will pop open. There is no need to remove the water bottle if you have one installed, but it can help improve access if needed. Please note that while most water bottle cages fit on the Penalty Box 2.0 cover, there are a small number that will not without some modifications. We recommend test-fitting the cage and ensuring that the latch has full range of motion to release the cover. In some cases, washers installed under the cage, along with required longer bolts, will create sufficient room for the latch to operate.



The cover features a special compartment to install a Tile or Airtag tracking device. To access the compartment, remove the waterbottle bolts and the nuts on the inside of the cover. Then remove the 2.5 hex bolt that is installed on the same cover frame piece that secures the tracking device compartment. The compartment can then be accessed. Follow the disassembly instructions in reverse to reassemble the cover.



TOOL WRAP TIPS (CARBON ONLY)

To make insertion and removal easiest, ensure the tube is fully deflated and tightly wrapped in the provide tube wrap. Ensure the strap is facing towards the opening so you can easily remove the wrap if it migrates down towards the bottom bracket area, or up towards the headtube area.

Try to not pack too many items in the tool wrap to ensure it can be easily inserted and removed. The tool wrap is designed to carry a small multitool, a small pump or CO2 inflation system, and various other small items like keys, money, and patch kits.

SPECIFICATIONS AND DIMENSIONS

MX (Mullet) Adjustment

The SM frame is equipped with 27.5" front and rear wheels while the MD-LG-XL frames are equipped with 29" front and rear wheels. The MD-LG-XL frames can be setup with MX wheel setup (29 Front / 27.5 Rear) if desired without any additional frame parts required. The MX adjustment is made by changing the position of the lower link shock mount chip. With a 5mm Hex key, remove the rear shock bolt from the non-drive side and position the chips on each side in the correct position for the MX setting. If switching back to a 29" setting, install the chips in the 29 position. Refer to the diagram below for the correct positions.

Chip in MX (27.5) position



Chip in 29 position



UDH HANGER

Your new frame is compatible with Sram's UDH hanger. No additional pieces are required for installation and the OEM equipped axle is compatible with the SRAM UDH Hanger.

1.



2.



SHOCK BEARING EYELET AND HARDWARE

Your frame is equipped with cartridge bearings in the rear eyelet, allowing for better small-bump compliance. These bearings are carried by cups that have a very firm press fit into the shock shaft. If you have your shock serviced, we highly recommend removing these components, as suspension service centres cannot guarantee they will be returned.

The forward shock hardware is a combination of Rocky Mountain reducers (Part #5) and hardware provided by the shock manufacturer. Please see the chart below for technical information on all shock hardware, diagrams for reference, and instructions for removing the bearing eyelet system.

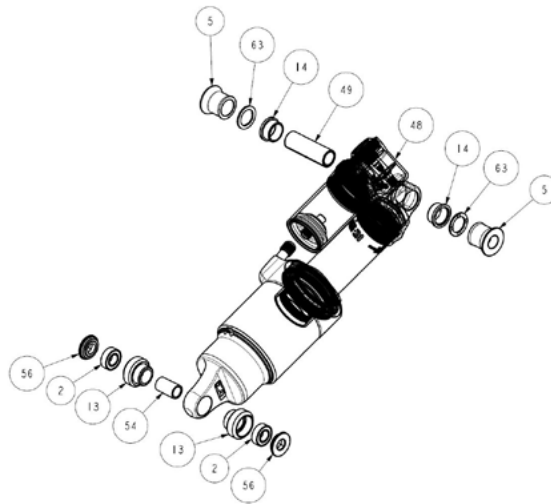

Altitude Rear Shock Bearing Eyelet - 35x8mm (Width x Hardware Diameter)

ITEM NUMBER	QTY	ITEM	PART NUMBER	DESCRIPTION
N/A	1	RMB Complete Kit	TBD	8 x 35mm Shock Bearing Eyelet Kit
2	2	Bearing	1801010	ENDURO 688 LLU MAX 16X8X5
13	2	Bearing Cup	1800031	BEARING EYELET FOR 16X8X5 BRG
54	1	Sleeve	1807028	BEARING EYELET CENTRE SLEEVE
56	2	Spacer	1804042	LOWER LINK SHOCK SPACER, 8 MM THRU

Altitude Forward Shock Hardware- 40x10mm (Shock Pin Width x Hardware Diameter)

ITEM NUMBER	QTY	ITEM	PART NUMBER	DESCRIPTION
5	2	Spacer	1804049	FORWARD SHOCK REDUCER 10 MM THRU
14	2	Fox Bushing	213-01-263	FOX IGUS BUSHING
	2	Rock Shox Bushing	11.4115.013.000	ROCK SHOX TEFLON BUSHING
49	1	Shock Pin	N/A	SHOCK PIN (See Complete Kit Information Below)
63	2	Shock Washer	N/A	CRUSH WASHER (See Complete Kit Information Below)
N/A	1	Fox Complete Kit	803-03-329	"FOX Mounting Hardware - 9 Piece SS 10mm x 40/1.575 *Do not use large plastic spacers included in kit"
N/A	1	Rock Shox Complete Kit	N/A	ASSY 3PC 1/2" HDW WD 3.65 SPCR 40.0X10
N/A	1	Rock Shox Complete Kit	11.4118.091.005	ROCK SHOX HARDWARE 10 x 20.0 *Discard pin
N/A	1	Rock Shox Complete Kit	11.4118.091.012	ROCK SHOX HARDWARE 10 x 40.0 *Discard spacers

Pro Tip: Fox Complete Kit is compatible with Rock Shox shocks eyelets. Remove the teflon bushing from the Rock Shox eyelet before installing the Fox kit.

SHOCK BEARING EYELET AND HARDWARE

Bearing Eyelet Removal

To remove the system, follow these steps

- Use the Rocky Mountain Bearing Eyelet Tool Kit (Part# 1810031)
- Install the top hat piece on one side of the bearing eyelet
- Next, install one of the cup removal tools over the bearing cup with the top hat piece installed.
- Thread the M8 screw snugly against the top hat piece.
- Install the other cup removal tool over the other bearing cup.
- Thread the M8 screw all the way in until it starts pushing on the other side. It is contacting the inside of the top hat piece.
- Keep threading until one of the cups is fully pushed out.
- Next insert the drift tool through the shock eyelet and rest it firmly against the bearing cup that is still pressed in the shock eyelet.
- Gently, but firmly, hammer the drift tool until the bearing cup is fully removed from the shock eyelet.

If you do not have the Rocky Mountain Bearing Eyelet Tool Kit, use a blind bearing puller:

- Use a blind bearing puller (8 mm extension) to remove both bearings. Install the top hat piece on one side of the bearing eyelet
- Remove the centre sleeve.
- Use the blind bearing puller (10 mm extension) to remove the empty cups.

NOTE: the inner diameter of the cups is 11 mm, which means the 12 mm extension won't fit (So don't force it); Use the 10 mm extension.

To install new cups, use a bearing press or vice with soft jaws installed, making sure to press on the outer edge of the cups, and don't forget the centre spacer sleeve between the cups.

SUSPENSION SETUP

Before changing your shock settings, it's important to educate yourself about the various adjustments that can be made.

Spring Adjustment

Depending on the shock model, you may need to adjust the coil spring rate or air pressure to achieve the recommended sag for Altitude. Consult the spring chart below for recommendations on coil spring rates and air pressures.

Rebound

Rebound adjustment controls how quickly your suspension returns to full extension after it hits a bump. Too much rebound control, and the fork or shock will move too slowly, sinking deeper and deeper into its travel under repeated hits, which will feel harsh. Too little, and the suspension can spring back too quickly, causing a loss of traction and control.

- Low Speed Rebound (LSR) refers to low fork or shock speed, not trail speed. This adjustment affects rebound rate in the first portion of the travel. For the sake of bracketing, we can assume from 0% to 40% travel.
- High Speed Rebound (HSR) refers to high fork or shock speed, not trail speed. This adjustment affects rebound rate in the second portion of the travel. For the sake of bracketing, we can assume from 40% to 100% travel.

Compression

Compression adjustment controls how quickly your suspension moves into its travel as it hits a bump. Too much compression control and the fork or shock will move too slowly and the force of the impact will rely too much on the tire and your body to absorb the movement. Too little compression and the fork or shock will move too quickly making the bike feel sluggish and unresponsive.

- Low speed compression (LSC) refers to low fork or shock speed, not trail speed. It controls rider weight shifts, pumping through terrain, G-outs, and other slow inputs. Too much LSC will result in a harsher ride feel; too little LSC will result in a ride feel that's too soft and unresponsive. LSC is effective throughout the entire range of travel.
- High speed compression (HSC) refers to high fork or shock speed, not trail speed. It controls the ability to absorb large impacts such as square edge rocks and bottom outs. Too much HSC will result in a harsher ride feel when riding fast, rough trails with many large bumps; too little HSC will result in not enough support when hitting those large bumps and might result in using all your suspension travel.

Hydraulic bottom out

Hydraulic Bottom Out (HBO) refers to the bottom out resistant that some shocks can provide in combination with an external adjuster. This affects the last 20% of the shock travel and it used for large impacts where the bike can bottom out.

Please see below tables for all OEM shock configurations for the Altitude. Due to the large number of shocks compatible with the Altitude, we cannot provide setup guides for models outside of the OEM specifications.

SUSPENSION SETUP

When tuning your suspension, write down your settings so you can refer back to them. Better yet, use an online spreadsheet on your phone!

Removing the shock on the Altitude with its LC2R suspension design can require extra steps. Here's a step-by-step guide on removal. For installation, simply follow the instructions in reverse. Be sure to note the torque values included in the SOP section of this manual.

1. Shift down to the small cog on the cassette and lock the derailleur cage open if possible.
2. Remove wheel.
3. Make sure the frame areas between the seat tube and link are clear of debris and clean.
4. Remove forward shock bolt.
 - Remember to support the rear triangle once the forward shock hardware is removed, and gently extended it back until the seatstay bridge contacts the seat tube.
5. Remove rear shock bolt.
 - If required, you can remove the Ride4 chips on both sides of the link.
6. Remove shock
 - The bearing eyelet spacers on each side will fall away, so be sure that you place a hand below the bearing eyelet area to catch these.



SUSPENSION SETUP

2024 ALTITUDE FOX DHX2 COIL SHOCK

SHOCK DIMENSIONS SM = 210 X 55MM MD - XL = 230 X 60MM

SHOCK TUNE CX001, JCR010, REZI BX001

NOTES *COUNT CLICKS FROM CLOSED: 0 CLICKS = CLOSED*

RIDER WEIGHT	STEEL SPRING	FOX SLS SPRING	SHOCK SAG	LSR	HSR	LSC	HSC
100lbs 45kg	300	275		10-11	6-7	14-15	6-7
110lbs 50kg	300	300		9--11	6-7	14-15	6-7
120lbs 55kg	350	325		8-9	6-7	14-15	6-7
130lbs 59kg	350	350		8-10	6-7	13-14	6-7
140lbs 64kg	400 (SM)	375		6-7	5-6	12-13	5-6
150lbs 68kg	400	400		6-7	5-7	11-13	5-6
160lbs 73kg	450 (MD)	425	SM	5-6	4-5	9-10	5-6
170lbs 77kg	450	450	16 - 19mm	5-6	4-5	9-11	4-6
180lbs 82kg	500 (LG)	475	MD - XL	4-5	4-5	9-10	4-5
190lbs 86kg	500	500	19 - 21mm	4-5	3-5	7-9	3-4
200lbs 91kg	550 (XL)	525		3-4	3-4	6-7	3-4
210lbs 95kg	600	550		2-3	2-3	5-6	2-3
220lbs 100kg	600			2-3	2-3	5-6	2-3
230lbs 105kg	650	Not Available		1-2	1-2	4-5	1-2
240lbs 109kg	700			1-2	0-1	3-4	0-1
250lbs 114kg	700			1-2	0-1	3-4	0-1

2024 ALTITUDE FOX DHX COIL SHOCK

SHOCK DIMENSIONS SM = 210 X 55MM MD - XL = 230 X 60MM

SHOCK TUNE CMSSB027, RF, REZI BVMLHB03LM

NOTES *COUNT CLICKS FROM CLOSED: 0 CLICKS = CLOSED*

RIDER WEIGHT	STEEL SPRING	FOX SLS SPRING	SHOCK SAG	LSR	HSR	LSC	HSC
100lbs 45kg	300	275		10		9 - Open	
110lbs 50kg	300	300		10		9	
120lbs 55kg	350	325		10 - 9		8 - 9	
130lbs 59kg	350	350		9		8	
140lbs 64kg	400 (SM)	375		9 - 8		7 - 8	
150lbs 68kg	400	400		8		7	
160lbs 73kg	450 (MD)	425	SM	8 - 7		6 - 7	
170lbs 77kg	450	450	16 - 19mm	7		6	
180lbs 82kg	500 (LG)	475	MD - XL	7 - 6	Not Available	5 - 6	Not Available
190lbs 86kg	500	500	19 - 21mm	6		5	
200lbs 91kg	550 (XL)	525		6 - 5		4 - 5	
210lbs 95kg	600	550		5		4	
220lbs 100kg	600			5 - 4		3 - 4	
230lbs 105kg	650	Not Available		4		3	
240lbs 109kg	700			4 - 3		2 - 3	
250lbs 114kg	700			3		2	

SUSPENSION SETUP

2024 ALTITUDE FOX FLOAT X2 AIR SHOCK

SHOCK DIMENSIONS SM = 210 X 55MM MD - XL = 230 X 60MM
 SHOCK TUNE 0.3 SPACER X1, CX001, JCR010, REZI BX001
 NOTES *COUNT CLICKS FROM CLOSED: 0 CLICKS = CLOSED*

RIDER WEIGHT	STEEL SPRING	SHOCK SAG	LSR	HSR	LSC	HSC
100lbs 45kg	120psi 8.3bar		11-13	5-6	14-16	6-7
110lbs 50kg	130psi 9bar		10-12	5-6	13-15	6-7
120lbs 55kg	140psi 9.7bar		9-11	4-5	13-15	6-7
130lbs 59kg	150psi 10.3bar		8-10	4-5	12-14	5-6
140lbs 64kg	160psi 11bar		7-9	4-5	11-13	5-6
150lbs 68kg	170psi 11.7bar		7-9	3-4	10-12	5-6
160lbs 73kg	180psi 12.4bar	SM	6-8	3-4	9-11	4-5
170lbs 77kg	190psi 13.1bar	16 - 19mm	6-8	3-4	8-10	4-5
180lbs 82kg	200psi 13.8bar	MD - XL	5-7	2-3	7-9	4-5
190lbs 86kg	210psi 14.5bar	19 - 21mm	4-6	2-3	6-8	4-5
200lbs 91kg	220psi 15.2bar		3-5	2-3	5-7	3-4
210lbs 95kg	230psi 15.9bar		2-4	2-3	4-6	3-4
220lbs 100kg	240psi 16.5bar		2-4	1-2	2-4	3-4
230lbs 105kg	250psi 17.2bar		1-3	1-2	2-4	3-4
240lbs 109kg	260psi 17.9bar		1-3	1-2	2-4	2-3
250lbs 114kg	270psi 18.6bar		1-2	1-2	1-3	1-2

2024 ALTITUDE FOX FLOAT X AIR SHOCK

SHOCK DIMENSIONS SM = 210 X 55MM MD - XL = 230 X 60MM
 SHOCK TUNE 0.4 SPACER, CMSSB024, RM, REZI BVMLHB01LM
 NOTES *COUNT CLICKS FROM CLOSED: 0 CLICKS = CLOSED*

RIDER WEIGHT	STEEL SPRING	SHOCK SAG	LSR	HSR	LSC	HSC
100lbs 45kg	120psi 8.3bar		10		9 - Open	
110lbs 50kg	130psi 9bar		10		9	
120lbs 55kg	140psi 9.7bar		10 - 9		8 - 9	
130lbs 59kg	150psi 10.3bar		9		8	
140lbs 64kg	160psi 11bar		9 - 8		7 - 8	
150lbs 68kg	170psi 11.7bar		8		7	
160lbs 73kg	180psi 12.4bar	SM	8 - 7		6 - 7	
170lbs 77kg	190psi 13.1bar	16 - 19mm	7		6	
180lbs 82kg	200psi 13.8bar	MD - XL	7 - 6	Not Available	5 - 6	Not Available
190lbs 86kg	210psi 14.5bar	19 - 21mm	6		5	
200lbs 91kg	220psi 15.2bar		6 - 5		4 - 5	
210lbs 95kg	230psi 15.9bar		5		4	
220lbs 100kg	240psi 16.5bar		5 - 4		3 - 4	
230lbs 105kg	250psi 17.2bar		4		3	
240lbs 109kg	260psi 17.9bar		4 - 3		2 - 3	
250lbs 114kg	270psi 18.6bar		3		2	

SUSPENSION SETUP

2024 ALTITUDE ROCK SHOX SUPER DELUXE AIR SHOCK

SHOCK DIMENSIONS SM = 210 X 55MM MD - XL = 230 X 60MM
 SHOCK TUNE OL1 PRM 32SN
 NOTES *COUNT CLICKS FROM CLOSED: 0 CLICKS = CLOSED*

RIDER WEIGHT	STEEL SPRING	SHOCK SAG	LSR	HSR	LSC	HSC
100lbs 45kg	110psi 7.6bar		11-12			
110lbs 50kg	120psi 8.3bar		10-11			
120lbs 55kg	130psi 9bar		9--11			
130lbs 59kg	140psi 9.7bar		8-9			
140lbs 64kg	150psi 10.3bar		8-10			
150lbs 68kg	160psi 11bar		6-7	Start at neutral setting (3rd position) Adjust 1 click at a time to achieve desired bottom-out feeling. The optional Hydraulic Bottom Out kicks in to restrict the flow of oil within the last 20% of travel, offering a soft hydraulic cushion that reduces harsh bottom out.	Start at neutral setting (3rd position) Adjust 1 click at a time to achieve desired support on low shaft speed movements, such as pumping through roller, preloading for a jump or drop, or more support while climbing.	Start at neutral setting (3rd position) Adjust 1 click at a time to achieve desired support on high shaft speed movements, such as square edge hits, rocky terrain, and large drops.
160lbs 73kg	170psi 11.7bar	SM	6-7			
170lbs 77kg	180psi 12.4bar	16 - 19mm	5-6			
180lbs 82kg	190psi 13.1bar		5-6			
190lbs 86kg	200psi 13.8bar	MD - XL	4-5			
200lbs 91kg	210psi 14.5bar	19 - 21mm	4-5			
210lbs 95kg	220psi 15.2bar		3-4			
220lbs 100kg	230psi 15.9bar		2-3			
230lbs 105kg	240psi 16.5bar		2-3			
240lbs 109kg	250psi 17.2bar		1-2			
250lbs 114kg	260psi 17.9bar		1-2			

2024 ALTITUDE ROCK SHOX SUPER DELUXE COIL SHOCK

SHOCK DIMENSIONS SM = 210 X 55MM MD - XL = 230 X 60MM
 SHOCK TUNE PRM 32SN
 NOTES *COUNT CLICKS FROM CLOSED: 0 CLICKS = CLOSED* COIL SPRING RATES FOR ROCK SHOX ARE 50# LESS THAN FOX FOR THE SAME SIZE FRAME. THE DIFFERENCE COMES DOWN TO THE DESIGN AND CHOSEN TUNE FOR THE ROCK SHOX REAR SHOCK.

RIDER WEIGHT	STEEL SPRING	SHOCK SAG	LSR	HSR	LSC	HSC
100lbs 45kg	300		11-12			
110lbs 50kg	300		10-11			
120lbs 55kg	300		9--11			
130lbs 59kg	350		8-9			
140lbs 64kg	350 (SM)		8-10	Start at neutral setting (3rd position) Adjust 1 click at a time to achieve desired bottom-out feeling. The optional Hydraulic Bottom Out kicks in to restrict the flow of oil within the last 20% of travel, offering a soft hydraulic cushion that reduces harsh bottom out.	Start at neutral setting (3rd position) Adjust 1 click at a time to achieve desired support on low shaft speed movements, such as pumping through roller, preloading for a jump or drop, or more support while climbing.	Start at neutral setting (3rd position) Adjust 1 click at a time to achieve desired support on high shaft speed movements, such as square edge hits, rocky terrain, and large drops.
150lbs 68kg	400		6-7			
160lbs 73kg	400(MD)	SM	6-7			
170lbs 77kg	450	16 - 19mm	5-6			
180lbs 82kg	450 (LG)		5-6			
190lbs 86kg	500	MD - XL	4-5			
200lbs 91kg	500 (XL)	19 - 21mm	4-5			
210lbs 95kg	550		3-4			
220lbs 100kg	600		2-3			
230lbs 105kg	600		2-3			
240lbs 109kg	650		1-2			
250lbs 114kg	700		1-2			

CABLE ROUTING-HOW-TO

These are instructions for both Carbon and Alloy Altitude frames. There are subtle differences in directions for each frame design so pay close attention to the instructions that apply to your specific frame.

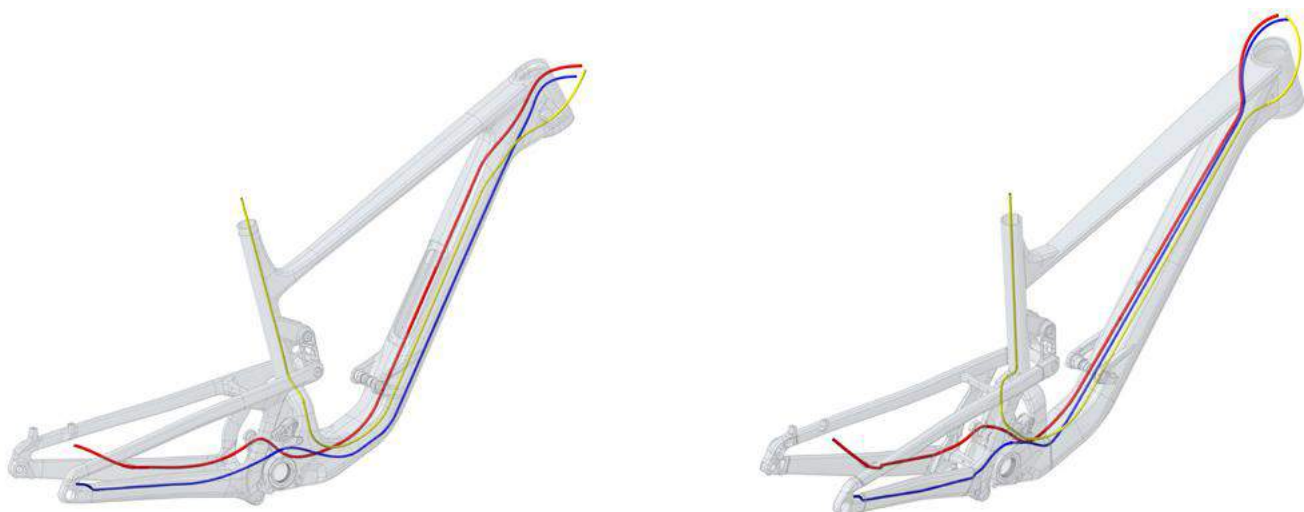

Removing the rear wheel and rear shock will allow you to cycle the rear triangle and give better access to direct the housing in the area between the rear and front triangles.

The tube-in-tube channels in the chainstay can sometimes be a tight fit, especially with the curves they sometimes must navigate. Spray soapy water or isopropyl alcohol into the opening as a lubricant to help with fitting the housing from one end to the other. Do not use grease or oil; this will leave a mess and attract dirt.

The Alloy frame does not have internal housing guides. It requires tools, such as the Park Tool IR-1.2 Internal Cable Routing Kit to aid in guiding and extracting all housing from the frame. We recommend installing the IR-1.2 wire in reverse, using the threaded barb connected to the new housing, and gently pulling the housing along towards the front of the frame.

REPLACING/INSTALLING REAR DERAILLEUR CABLE HOUSING

If you are replacing the old housing, remove it and cut a new piece to the same length. If you do not have the old piece, approximate the length required and cut a slightly longer portion.

1. Remove non-drive side head tube port cover.

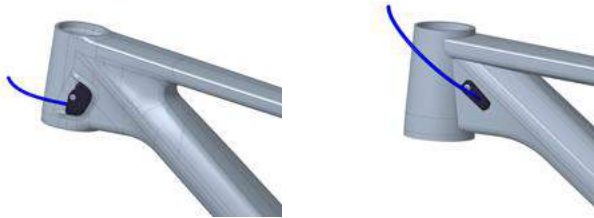

2. Beginning from the rear of the bike, begin feeding the housing into the cable opening on the drive side chain stay. Push the housing forward and simultaneously twist the housing until it comes out at the forward end of the chain stay.



3. Guide the housing into the housing port above the bottom bracket. Make sure you insert the derailleur housing into the drive side port.



4. Push the cable from the rear until it comes out at the head tube port.

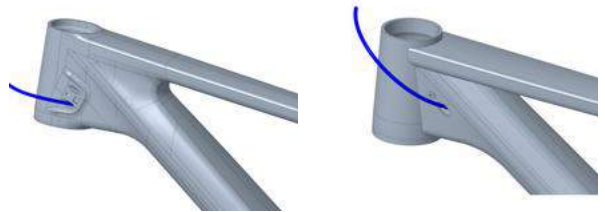

5. Once the housing is fully installed between the shifter and rear derailleur, re-install the headtube port. For the Alloy frame, ensure you install the 4mm foam housing included with the frame. In the case of replacing original foam housing, the housing may have fallen inside the frame, which will require you to carefully fish it out.

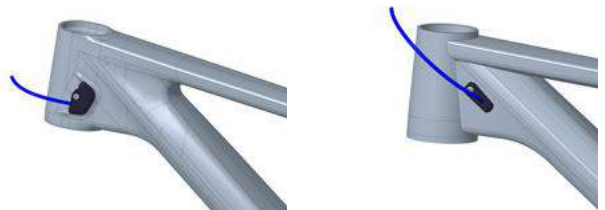

6. For the Alloy frame, ensure that you fasten the housing to the guide on the inside of the shock tunnel. This will prevent the housing from touching the shock.



REPLACING/INSTALLING DROPPER POST CABLE HOUSING

1. Depending on the location of the rear brake hose, remove the drive or non-drive side head tube port cover.



2. For Carbon: beginning from the head tube port, begin feeding the housing into the bottom housing opening. Push the housing forward until it comes out at the seat tube.



3. For Alloy: insert the housing at the seat tube opening then guide it into the port in the downtube

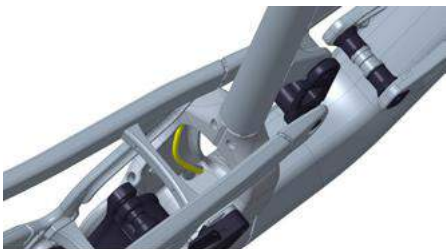

4. For Alloy: guide the housing until it comes out the cable port at the headtube. Don't forget to install the 4mm foam housing included with the frame. In the case of replacing original foam housing, the housing may have fallen inside the frame, which will require you to carefully fish it out.



5. Complete the dropper post installation as per the dropper post manufacturer's instructions.

6. Once the seat post is correctly installed, re-install the headtube port.

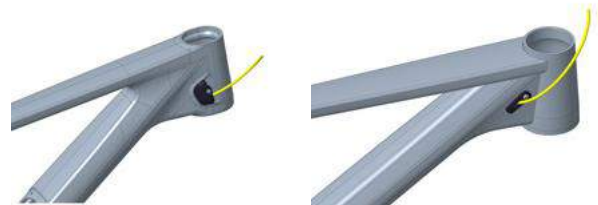

7. For the Alloy frame, ensure that you fasten the housing to the guide on the inside of the shock tunnel. This will prevent the housing from touching the shock.



REPLACING/INSTALLING REAR HYDRAULIC BRAKE HOSE

1. Depending on the location of the rear brake hose, remove the drive or non-drive side head tube port cover. If

Regular Routing = Non-Drive side

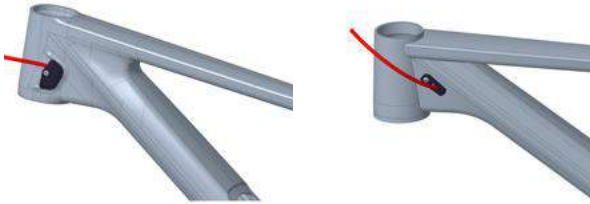

Moto | UK-AUS Routing = Drive side

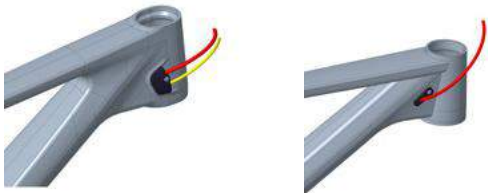

2. For Alloy frames, remove the cover on the inside of the chainstay



3. Starting at the rear of the frame, push the hose forward until it comes out at the forward end of the chain stay.

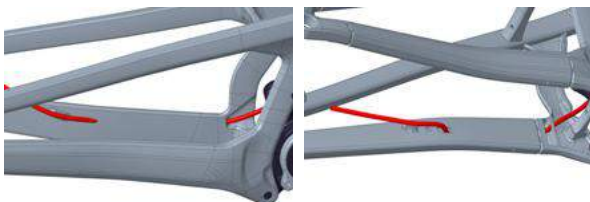

4. Guide the brake hose into the housing port above the bottom bracket. Make sure you insert the brake hose (Red) into the Non-Drive Side port.

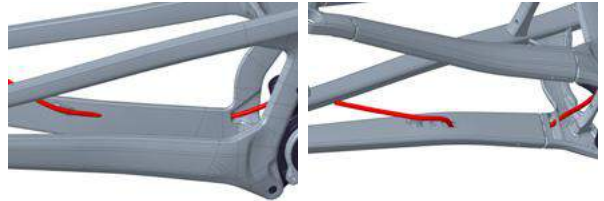

5. For Carbon frames, remove the Penalty Box cover to access the inner housing tubes. At the interrupted housing tube portion, guide the brake hose in the desired channel. The lower channel is for standard rear brake lever position. The brake hose will pop out on the frame's non-drive side and then cross over to the right-hand side to the lever. The upper channel is for Moto | UK-AUS rear brake lever position (left-hand side).

Regular Routing = Lower Tube



Moto | UK-AUS Routing = Upper Tube

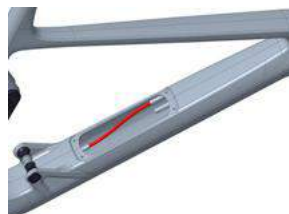

REPLACING/INSTALLING REAR HYDRAULIC BRAKE HOSE

6. Then Push the brake hose from the rear until it comes out at the head tube port.

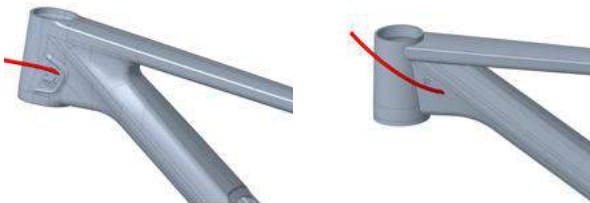

7. For Alloy frames guide the housing until it comes out the cable port at the headtube. Don't forget to install the 5mm foam housing included with the frame. In the case of replacing original foam housing, the foam tubes may have fallen inside the frame, which will require you to carefully fish it out.

8. Once the brake hose is installed replace the headtube port cover

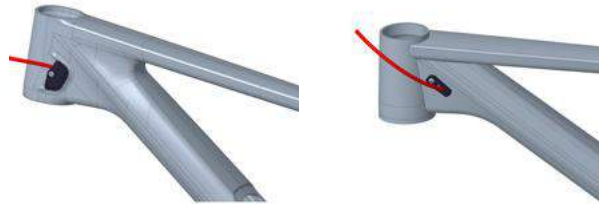

9. For the Alloy frame, ensure that you fasten the housing to the guide on the inside of the shock tunnel. This will prevent the housing from touching the shock.

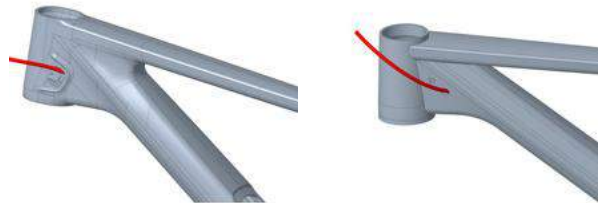

CRITICAL DIMENSIONS

ITEM NUMBER	CATEGORY	ITEM	DIMENSION	PART NUMBER	DESCRIPTION
1	Headset	Carbon Frame Headset	FSA No.85-10mm Offset		FSA No.85-10mm Offset Headset, complete. See Headset chart for information
		Carbon Frame Headset Cup Set	FSA No.85-15mm Offset		FSA No.85-15mm Offset cups only. See Headset chart for information
		Alloy Frame Headset	FSA ZS56 66 0mm Offset		FSA RMB ZS56 66 0mm Offset Headset, complete. See Headset chart for information
		Alloy Frame Headset Cup Set	FSA ZS56 66 5mm Offset		FSA RMB ZS56 66 5mm Offset cups only. See Headset chart for information
2	Fork	Fork Travel	170mm		
		Fork Offset	SM = 37mm		
		Maximum Axle to Crown Height	MD - LG - XL = 42 - 44mm SM = 567mm MD - LG - XL = 586mm		
3	Shock	Shock Size	SM = 210 x 55mm MD - LG - XL = 230 x 60mm		MD - LG - XL frames are compatible with 210 x 55mm
		Shock Tune	See Description		Refer to Shock Setup chart for tune information
		Forward Shock Hardware	40 x 10mm		Requires custom hardware. See Shock Hardware chart for information
		Rear Shock Hardware	35 x 8mm	1811007	Requires custom bearing eyelet hardware. See Shock Hardware chart for information
		Approved Shock Fitment	See Description		All Fox rear shock models All Rock Shox rear shock models All Cane Creek Shock models
4	Seatpost	Seat Tube Inner Diameter	30.9mm		For seatpost sizing
		Seat Tube Outer Diameter	34.9mm		For seat clamp sizing
		Seat Tube Minimum Insertion	100mm		
		Seat Tube Machined Ream Depth	SM = 202 192mm MD = 250 240mm		For seatpost fitment information, refer to the seatpost fitment section in this manual
		Carbon Alloy	LG = 280 270mm XL = 310 300mm		

CRITICAL DIMENSIONS

ITEM NUMBER	CATEGORY	ITEM	DIMENSION	PART NUMBER	DESCRIPTION
5	Crankset	Chaining Size Range	Minimum = 30 Maximum 34T		
		OEM Chaining Size Chain Length	SM = 32T 116L		
			MD = 32T 118L118L		
			LG - XL = 32T 120L		
		Chain Guide Kit	See Description	TBD	Altitude specific Canadarm 2.0 + OneUp Upper Guide Compatible
		Chain Guide	OneUp Top Guide	IC0686	For individual parts see exploded diagram
		Bashguard	2-Bolt ISCG05		2-Bolt ISCG05 mounting pattern to fit bashguards only
	Bottom Bracket	BSA 73mm			
	Chainline Range	52 - 55mm			
6	Brake	Maximum Rotor Diameter	220mm		
		Maximum Rotor Thickness	2.3mm		
7	Wheel	Wheel Size	SM = 27.5"		
			MD - LG - XL = 29"		MX (Mullet) Compatible via flip-chip
8	Rear Hub	Maximum Tire Width	2.5" 63mm		
		Hub Spacing	12 x 148mm		
		Rear Axle	12 x 1.0 x 173mm		Diameter 12mm x Thread Pitch 1.0mm x Length 173mm
		Replacement Axle	See Description	3222000	Diameter 12mm x Thread Pitch 1.0mm x Length = 173mm
		Complete Hanger Kit	See Description	1812002	Includes Hanger, nut, and washer. For individual parts see exploded diagram
	UDH Transmission	See Description		Frame is UDH and Transmission compatible	

EXPLODED VIEW

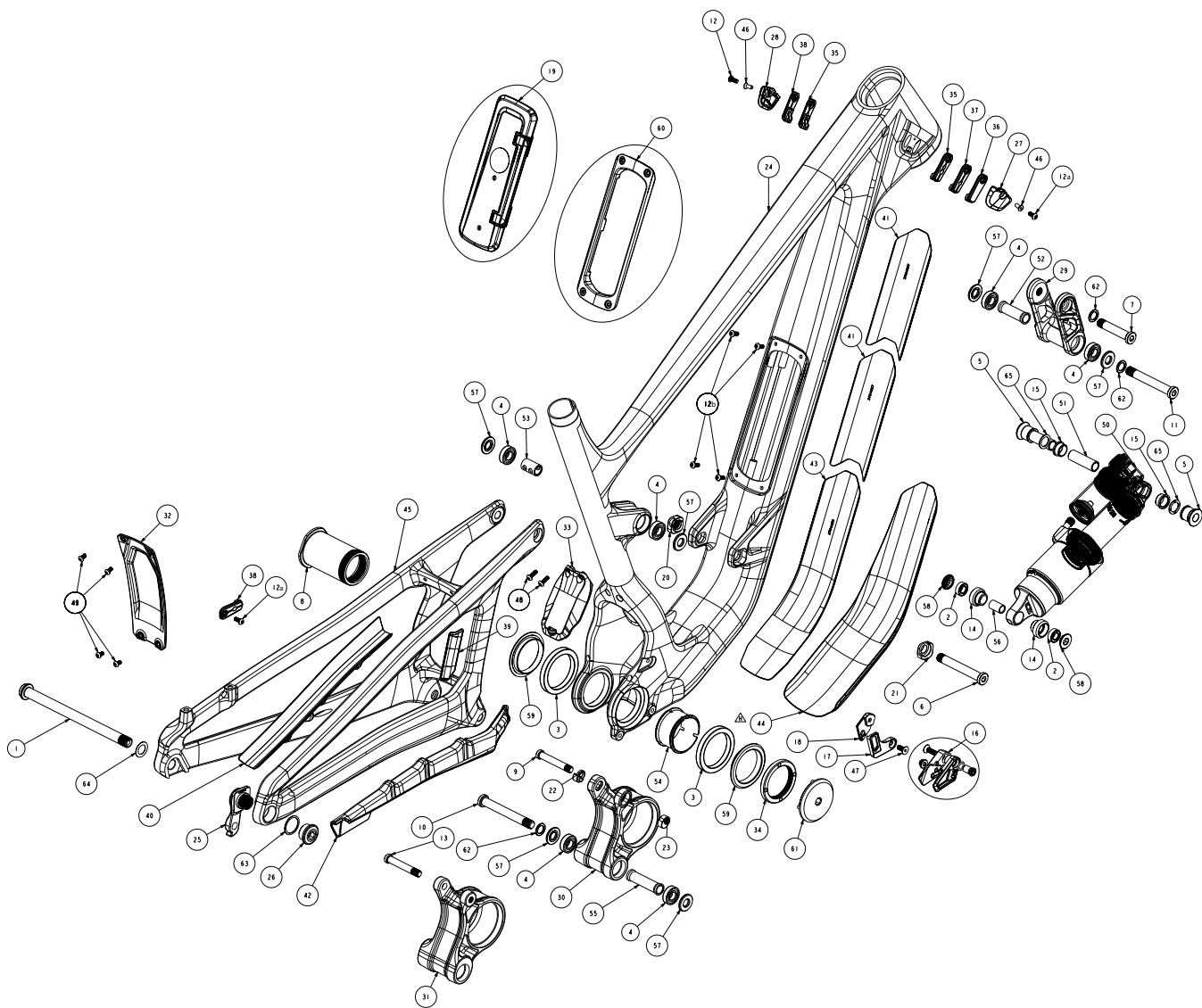

PARTS LIST AND ASSEMBLY INSTRUCTIONS

#	QTY	ITEM	PART NO.	INSTALLATION NOTES		
				TORQUE (Nm)	DESCRIPTION	INSTALLATION NOTES
1	1	AXLE, REAR	3222000	10	REAR AXLE 12X1.0 L:173MM, HARD BLACK ANODIZE	Apply grease to axle shaft and threads. Use
2	2	BEARING	1801010		ENDURO 688 LLU MAX 16X8X5	
3	2	BEARING	1804045		24ASPT ALTITUDE MP BEARING 6809 45X58X7	
4	6	BEARING	1807042		ENDURO BEARING 6900 2RS MAX TYPE, 22X10X6 SIZE	
5	2	BEARING SPACER	1804049		FORWARD SHOCK REDUCER 10 MM THRU	
6	1	BOLT	1804033	10	FORWARD SHOCK BOLT, M10x1.0, L:72	Apply grease to pivot bolts, and Loctite 243
7	1	BOLT	1804036	10	TOP LINK, TOP BOLT, M10x1.0, L:51, 6MMHEX	Apply grease to pivot bolts, and Loctite 243
8	1	BOLT	1804037		MAIN PIVOT BOLT (M43x1.5, OD: 43, L:70, ID BSA)	Apply grease to MP bolt and screw threads.
9	1	BOLT	1804040	10	LOWER LINK SHOCK BOLT, M8x1.0, L:51	Apply grease to pivot bolts, and Loctite 243
10	1	BOLT	1804047	10	LOWER LINK LOWER BOLT M10x1.0, L81.5	Apply grease to pivot bolts, and Loctite 243
11	1	BOLT	1804053	10	TOP LINK LOWER BOLT M10x1.0, L74	Apply grease to pivot bolts, and Loctite 243
12	7	BOLT	1804060	< 1	M4x0.7 10MM HEX BUTTON HEAD	a) Apply grease (alloy only). b) Apply Loctite 243 (blue) (carbonyl)
13	1	BOLT	1805169	10	LOWER 27.5 LINK SHOCK BOLT, M8x1.0, L:51, 11 MM THREAD	Apply grease to pivot bolts, and Loctite 243
14	2	BRG CUP	1800031		BEARING EYELET FOR 16x8X5 BRG	
15	2	BUSHING, FOX	N/A		FOX_LIGUS_BUSHING	
16	1	CHAINGUIDE	3391004		ONEUP CHAINGUIDE ASSEMBLY (1C0686)	
17	1	CHAINGUIDE BA	1394003		BASEPLATE FOR CHAINGUIDE	
18	1	CHAINGUIDE SLII	3391002		SLIDING PART OF CHAINGUIDE	
19	1	COMPLETE COVER	1994031		PENALTYBOX 2 COMPLETE COVER SUB-ASSEMBLY	Carbon only.
20	1	FLIP CHIP	1804032		RIDE 4 CHIP - THREADED, M10x1.0, T:10	
21	1	FLIP CHIP	1804034		RIDE 4 CHIP - 10 mm THRU	
22	1	FLIP CHIP	1804041		LOWER LINK FLIP CHIP 29 AND MX	
23	1	FLIP CHIP	1804043		LOWER LINK CHIP THREAD, M8x1.0, 29 OR MX	
24	1	FRONT TRIANGLE	B064112CBN		2024 ALTITUDE CARBON FRONT TRIANGLE - SIZE LARGE	
25	1	HANGER	1092003		MY22 REAR DER. HANGER, M12X1, UDH COMPATIBLE	
26	1	HANGER NUT	1801008	20	RMB UDH HANGER NUT, 7075_T6, HARD BLACK ANODIZED	Apply Loctite 243 (blue) to threads.
27	1	HT PORT COVER	1803012		2023 SLAYER CARBON HT PORT COVER, RIGHT	Carbon only.
28	1	HT PORT COVER	1803013		2023 SLAYER CARBON HT PORT COVER, LEFT	Carbon only.
29	1	LINK	1094001		2024 ALTITUDE TOP LINK	
30	1	LINK	1094002		2024 ALTITUDE LOWER LINK, 29"	Use 1804040 shock bolt with 29/MX link.
31	1	LINK	1094003		MY24 ALTITUDE LOWER LINK, 27.5" SIZE SMALL	Use 1805169 shock bolt for 27.5" link.
32	1	MUD GUARD	1994026		2024 ALTITUDE REAR TRIANGLE MUD GUARD	
33	1	MUD GUARD	1994027		2024 ALTITUDE SHOCK MUD GUARD	
34	1	NUT	1804038	25	MP NUT M43X1.5, T:7, OD:54.5	Install using RMB BB/MP Tool (PART # 1804039).
35	2	PORT COVER	1093011		ALLOY CABLE PORT COVER DOUBLE HOLE	Alloy only.
36	1	PORT COVER	1093012		ALLOY CABLE PORT COVER BLANK	Alloy only.
37	1	PORT COVER	1093013		ALLOY CABLE PORT COVER SINGLE 4mm HOLE	Alloy only.
38	2	PORT COVER	1093014		ALLOY CABLE PORT COVER SINGLE 5mm HOLE	Alloy only.
39	1	PROTECTOR	3704055		2024 ALTITUDE CHAIN STAY UPPER PROTECTOR	
40	1	PROTECTOR	3704056		2024 ALTITUDE SEAT STAY PROTECTOR	
41	2	PROTECTOR	3704057		2024 ALTITUDE TAILGATE PROTECTOR	
42	1	PROTECTOR	3704058		2024 ALTITUDE CHAIN STAY LOWER PROTECTOR	
43	1	PROTECTOR	3704059		2024 ALTITUDE DOWN TUBE PROTECTOR	Alloy
44	1	PROTECTOR	3704108		MY24 ALTITUDE CARBON DOWN TUBE PROTECTOR	Carbon
45	1	REAR TRIANGLE	I054112CBN		2024 ALTITUDE CARBON REAR TRIANGLE - SIZE LARGE & X-LARGE	
46	2	SCREW	1800024-BK	< 1	C'SUNK SOCKET SCREW, M4x10MM, 10.9 STEEL, BLACK	Apply grease to screw threads (carbon only).
47	1	SCREW	1804055	< 2	C'SUNK SOCKET SCREW, M5X0.8, L:12 MM, 3MM HEX, SS	Apply Loctite 243 (blue) to threads.
48	2	SCREW	1804067	< 1	M4x0.7 DOME HEAD SCREW, L:12, HEX 2.5	Apply grease to screw threads.
49	4	SCREW	1804068	< 1	M4x0.7 DOME HEAD SCREW, L:7, HEX 2.5	Apply grease to screw threads.
50	1	SHOCK	N/A		REAR SHOCK, 230X60	
51	1	SHOCK, PIN	N/A		SHOCK PIN: ID:10 MM, L:40 MM, STEEL	
52	1	SLEEVE	1800010		SS BEARING SLEEVE, ID:10, OD:14, L:41, NECKED	
53	1	SLEEVE	1804035		TOP LINK UPPER SLEEVE, OD:14, ID: 10.2, L:22	
54	1	SLEEVE	1804044		MAIN PIVOT SLEEVE L:29 ID:43 OD:49	
55	1	SLEEVE	1804048		LOWER LINK SLEEVE, ID:10.2, OD:14, L:50	
56	1	SLEEVE	1807028		BEARING EYELET CENTRE SLEEVE	
57	6	SPACER	1800009		LINK BEARING SPACER, OD:22, ID:10, T:2.5	
58	2	SPACER	1804042		LOWER LINK SHOCK SPACER, 8 MM THRU	
59	2	SPACER	1804046		MP BEARING SPACER ID:45 OD:57 T:8	
60	1	SUBFRAME S-A	1814004		PENALTYBOX 2 MOUNTING FRAME	Carbon only.
61	1	TOOL	1804039		BOTTOM BRACKET TOOL	BB/MP nut installation tool. Ensure tool is
62	3	WASHER	1800019		WASHER ID: 10.2, OD: 15.5, T: 1	
63	1	WASHER	1801009		WASHER, 20X24X0.5MM, 304 SS	
64	1	WASHER	3227006		WASHER, 12x19x0.5MM, 304 SS	
65	2	WASHER	N/A		SHOCK CRUSH WASHER	
66	1	LINK	1094001P		2024 ALTITUDE TOP LINK POLISHED	
67	1	LINK	1094002P		2024 ALTITUDE LOWER LINK, 29" POLISHED	
68	1	LINK	1094003P		MY24 ALTITUDE LOWER LINK, 27.5" SIZE SMALL POLISHED	
1	1	HEAD SET CUP	1194002		FSA 5MM OFFSET OVAL CUPS W/ORING CR BIKES	
1	1	HEAD SET CUP	1194004		FSA 5MM OFFSET CUPS AL BIKES	
1	1	HEADSET	1194001		FSA NO.85 1.5" OMM OFFSET OVAL CUPS STAINLESS	
1	1	HEADSET	1194003		FSA ZS56 66 OMM OFFSET HS STAINLESS STEEL	

SMALL PARTS KITS LIST

2024 ALTITUDE CARBON ALLOY					
#	QTY	ITEM	PART NO.	SUPPLIER	REVISION DESCRIPTION
2024 ALTITUDE UPPER LINK KIT WITH BEARINGS					
			1814020	ZCA013	
29	1	LINK	1094001	PTW385	2024 ALTITUDE TOP LINK
4	2	BEARING	1807042	PUS098	ENDURO BEARING 6900 2RS MAX TYPE, 22X10X6 SIZE
52	1	SLEEVE	1800010	PTW047	SS BEARING SLEEVE, ID:10, OD:14, L:41, NECKED
2024 ALTITUDE 29 LOWER LINK KIT WITH BEARINGS					
			1814021	ZCA013	
30	1	LINK	1094002	PTW385	2024 ALTITUDE LOWER LINK, 29"
4	2	BEARING	1807042	PUS098	ENDURO BEARING 6900 2RS MAX TYPE, 22X10X6 SIZE
55	1	SLEEVE	1804048	PTW047	LOWER LINK SLEEVE, ID:10.2, OD:14, L:50
3	2	BEARING	1804045	PUS098	24ASPT ALTITUDE MP BEARING 6809 45X58X7
54	1	SLEEVE	1804044	PTW047	MAIN PIVOT SLEEVE L:29 ID:43 OD:49
2024 ALTITUDE 27.5 LOWER LINK KIT WITH BEARINGS					
			1814022	ZCA013	
31	1	LINK	1094003	PTW385	MY24 ALTITUDE LOWER LINK, 27.5" SIZE SMALL
4	2	BEARING	1807042	PUS098	ENDURO BEARING 6900 2RS MAX TYPE, 22X10X6 SIZE
55	1	SLEEVE	1804048	PTW047	LOWER LINK SLEEVE, ID:10.2, OD:14, L:50
3	2	BEARING	1804045	PUS098	24ASPT ALTITUDE MP BEARING 6809 45X58X7
54	1	SLEEVE	1804044	PTW047	MAIN PIVOT SLEEVE L:29 ID:43 OD:49
2024 ALTITUDE UPPER LINK POLISHED KIT WITH BEARING					
			1814020P	ZCA013	
66	1	LINK	1094001P	PTW385	2024 ALTITUDE TOP LINK POLISHED
4	2	BEARING	1807042	PUS098	ENDURO BEARING 6900 2RS MAX TYPE, 22X10X6 SIZE
52	1	SLEEVE	1800010	PTW047	SS BEARING SLEEVE, ID:10, OD:14, L:41, NECKED
2024 ALTITUDE 29 LOWER LINK POLISHED KT WITH BEARING					
			1814021P	ZCA013	
67	1	LINK	1094002P	PTW385	2024 ALTITUDE LOWER LINK, 29" POLISHED
4	2	BEARING	1807042	PUS098	ENDURO BEARING 6900 2RS MAX TYPE, 22X10X6 SIZE
55	1	SLEEVE	1804048	PTW047	LOWER LINK SLEEVE, ID:10.2, OD:14, L:50
3	2	BEARING	1804045	PUS098	24ASPT ALTITUDE MP BEARING 6809 45X58X7
54	1	SLEEVE	1804044	PTW047	MAIN PIVOT SLEEVE L:29 ID:43 OD:49
2024 ALTITUDE 27.5 LOWER LINK POLISH KT WITH BEARING					
			1814022P	ZCA013	
68	1	LINK	1094003P	PTW385	MY24 ALTITUDE LOWER LINK, 27.5" SIZE SMALL POLISHED
4	2	BEARING	1807042	PUS098	ENDURO BEARING 6900 2RS MAX TYPE, 22X10X6 SIZE
55	1	SLEEVE	1804048	PTW047	LOWER LINK SLEEVE, ID:10.2, OD:14, L:50
3	2	BEARING	1804045	PUS098	24ASPT ALTITUDE MP BEARING 6809 45X58X7
54	1	SLEEVE	1804044	PTW047	MAIN PIVOT SLEEVE L:29 ID:43 OD:49
2022 HANGER KIT 12 x1.0					
			1812002		
25	1	HANGER	1092003	PTW047	MY22 REAR DER. HANGER, M12X1, UDH COMPATIBLE
26	1	HANGER NUT	1801008	PTW047	RMB UDH HANGER NUT, 7075_T6, HARD BLACK ANODIZED
63	1	WASHER	1801009	PTW047	WASHER, 20X24X0.5MM, 304 SS
2024 ALTITUDE PIVOT BOLT KIT					
			1814018	PTW047	
7	1	BOLT	1804036	PTW047	TOP LINK, TOP BOLT, M10x1.0, L:51, 6MMHEX
10	1	BOLT	1804047	PTW047	LOWER LINK LOWER BOLT M10x1.0, L81.5
11	1	BOLT	1804053	PTW047	TOP LINK LOWER BOLT M10x1.0, L74
57	6	SPACER	1800009	PTW047	LINK BEARING SPACER, OD:22, ID:10, T:2.5
62	3	WASHER	1800019	PTW047	WASHER ID: 10.2, OD: 15.5, T: 1
2024 ALTITUDE MAIN PIVOT KIT					
			1814019	PTW047	
8	1	BOLT	1804037	PTW047	MAIN PIVOT BOLT (M43x1.5, OD: 43, L:70, ID BSA)
34	1	NUT	1804038	PTW047	MP NUT M43X1.5, T:7, OD:54.5
59	2	SPACER	1804046	PTW047	MP BEARING SPACER ID:45 OD:57 T:8
2024 ALTITUDE MAIN PIVOT TOOL					
			1814023	PTW047	
61	1	TOOL	1804039	PTW047	BOTTOM BRACKET TOOL

SMALL PARTS KITS LIST

		1814024	ZCA013	2024 ALTITUDE PIVOT BEARING KIT
3	2 BEARING	1804045	PUS098	24ASPT ALTITUDE MP BEARING 6809 45X58X7
4	6 BEARING	1807042	PUS098	ENDURO BEARING 6900 2RS MAX TYPE, 22X10X6 SIZE
53	1 SLEEVE	1804035	PTW047	TOP LINK UPPER SLEEVE, OD:14, ID: 10.2, L:22
		1814025	ZCA013	2024 ALTITUDE MAIN PIVOT BEARING ONLY KIT
3	2 BEARING	1804045	PUS098	24ASPT ALTITUDE MP BEARING 6809 45X58X7
		1814026	PTW047	2024 ALTITUDE SHOCK BOLT KIT
6	1 BOLT	1804033	PTW047	FORWARD SHOCK BOLT, M10x1.0, L:72
9	1 BOLT	1804040	PTW047	LOWER LINK SHOCK BOLT, M8x1.0, L:51
		1814058	PTW047	2024 ALTITUDE SHOCK BOLT KIT SM
6	1 BOLT	1804033	PTW047	FORWARD SHOCK BOLT, M10x1.0, L:72
13	1 BOLT	1805169		LOWER 27.5 LINK SHOCK BOLT, M8x1.0, L:51, 11 MM THREAD
		1814027	ZCA013	2024 ALTITUDE SHOCK BEARING EYELET KIT
2	2 BEARING	1801010	PUS098	ENDURO 688 LLU MAX 16X8X5
56	1 SLEEVE	1807028	PTW047	BEARING EYELET CENTRE SLEEVE
14	2 BRG CUP	1800031	PTW047	BEARING EYELET FOR 16X8X5 BRG
58	2 SPACER	1804042	PTW047	LOWER LINK SHOCK SPACER, 8 MM THRU
		1814028	PTW047	2024 ALTITUDE FORWARD SHOCK REDUCER KIT
5	2 BEARING SPACER	1804049	PTW047	FORWARD SHOCK REDUCER 10 MM THRU
		1812007		AXLE KIT BOOST 12X1.0
1	1 AXLE, REAR	3222000	PTW047	REAR AXLE 12X1.0 L:173MM, HARD BLACK ANODIZE
64	1 WASHER	3227006	PTW047	WASHER, 12x19x0.5MM, 304 SS
		1813467	PTW047	NEW HEAD TUBE PANEL KIT (FROM 2023)
27	1 HT PORT COVER	1803012	PTW047	2023 SLAYER CARBON HT PORT COVER, RIGHT
28	1 HT PORT COVER	1803013	PTW047	2023 SLAYER CARBON HT PORT COVER, LEFT
46	2 SCREW, M4X10	1800024-BK	PTW047	C'SUNK SOCKET SCREW, M4x10MM, 10.9 STEEL, BLACK
		1814039	ZCA013	ALLOY FRAME HT CABLE PORT KIT
12	3 BOLT	1804060	PTW047	M4x0.7 10MM HEX BUTTON HEAD
35	2 PORT COVER	1093011	P0072	ALLOY CABLE PORT COVER DOUBLE HOLE
36	1 PORT COVER	1093012	P0072	ALLOY CABLE PORT COVER BLANK
37	1 PORT COVER	1093013	P0072	ALLOY CABLE PORT COVER SINGLE 4mm HOLE
38	2 PORT COVER	1093014	P0072	ALLOY CABLE PORT COVER SINGLE 5mm HOLE
		1814040	ZCA013	ALLOY FRAME CS CABLE PORT KIT
12	1 BOLT	1804060	PTW047	M4x0.7 10MM HEX BUTTON HEAD
38	1 PORT COVER	1093014	P0072	ALLOY CABLE PORT COVER SINGLE 5mm HOLE
		1814029	PTW047	RIDE 4 THREADED 10MM CHIP KIT
20	1 FLIP CHIP	1804032	PTW047	RIDE 4 CHIP - THREADED, M10x1.0, T:10
21	1 FLIP CHIP	1804034	PTW047	RIDE 4 CHIP - 10 mm THRU
		1814031	PTW047	2024 ALTITUDE LOWER LINK FLIP CHIP
22	1 FLIP CHIP	1804041	PTW047	LOWER LINK FLIP CHIP 29 AND MX
23	1 FLIP CHIP	1804043	PTW047	LOWER LINK CHIP THREAD, M8x1.0, 29 OR MX
		1814032	ZCA013	2024 ALTITUDE ALLOY PROTECTION KIT
39	1 PROTECTOR	3704055	PTW110	2024 ALTTIUDE CHAIN STAY UPPER PROTECTOR
40	1 PROTECTOR	3704056	PTW110	2024 ALTTIUDE SEAT STAY PROTECTOR
41	2 PROTECTOR	3704057	PTW110	2024 ALTTIUDE TAILGATE PROTECTOR
42	1 PROTECTOR	3704058	PTW110	2024 ALTTIUDE CHAIN STAY LOWER PROTECTOR
43	1 PROTECTOR	3704059	PTW110	2024 ALTTIUDE DOWN TUBE PROTECTOR

SMALL PARTS KITS LIST

		1814062	ZCA013	2024 ALTIITUDE CARBON PROTECTION KIT
39	1 PROTECTOR	3704055	PTW110	2024 ALTIITUDE CHAIN STAY UPPER PROTECTOR
40	1 PROTECTOR	3704056	PTW110	2024 ALTIITUDE SEAT STAY PROTECTOR
41	2 PROTECTOR	3704057	PTW110	2024 ALTIITUDE TAILGATE PROTECTOR
42	1 PROTECTOR	3704058	PTW110	2024 ALTIITUDE CHAIN STAY LOWER PROTECTOR
44	1 PROTECTOR	3704108	PTW110	MY24 ALTIITUDE CARBON DOWN TUBE PROTECTOR
		1814033	ZCA013	2024 ALTIITUDE MUD GUARD KIT
32	1 MUD GUARD	1994026	P0072	2024 ALTIITUDE REAR TRIANGLE MUD GUARD
49	4 SCREW	1804068	PTW047	M4x0.7 DOME HEAD SCREW, L:7, HEX 2.5
33	1 MUD GUARD	1994027	P0072	2024 ALTIITUDE SHOCK MUD GUARD
48	2 SCREW	1804067	PTW047	M4x0.7 DOME HEAD SCREW, L:12, HEX 2.5
		1814034	ZCA013	2024 ALTIITUDE CHAIN GUIDE
16	1 CHAINGUIDE	3391004	PTW021	ONEUP CHAINGUIDE ASSEMBLY (1C0686)
17	1 CHAINGUIDE BASE	1394003	PTW047	BASEPLATE FOR CHAINGUIDE
18	1 CHAINGUIDE SLIDE	3391002	PTW047	SLIDING PART OF CHAINGUIDE
47	1 SCREW	1804055	PTW047	C'SUNK SOCKET SCREW, M5X0.8, L:12 MM, 3MM HEX, SS
		1814042	PTW047	PENALTYBOX 2 COVER KIT
19	1 COMPLETE COVER S-A	1994031	PTW047	PENALTYBOX 2 COMPLETE COVER SUB-ASSEMBLY
		1814043	ZCA013	PENALTYBOX 2 WB MOUNT INSERT KIT
	2 M5 BARREL	1994049	P0072	BOTTLE CAGE M5 BARREL
	2 SCREW	1804074	PTW047	LOW PROFILE WATER BOTTLE SCREW M5x15
		1814044	ZCA013	PENALTYBOX 2 FRAME MOUNT KIT
60	1 SUBFRAME S-A	1814004	P0072	PENALTYBOX 2 MOUNTING FRAME
12	7 BOLT	1804060	PTW047	M4x0.7 10MM HEX BUTTON HEAD
	1 WRAP	AC00340S1	P0064	RMB TOOL WRAP 23 OS BK
	1 BAG	AC00330S1	P0064	RMB TUBE BAG 23 OS BK
		1814050	ZCA013	5M OFFSET HEAD SET CUPS KIT CR BIKES
	1 HEAD SET CUP	1194002	PUS105	FSA 5MM OFFSET OVAL CUPS W/ORING CR BIKES
		1814051	ZCA013	5M OFFSET HEAD SET CUPS KIT AL BIKES
	1 HEAD SET CUP	1194004	PUS105	FSA 5MM OFFSET CUPS AL BIKES
		1814052	ZCA013	OVAL OFFSET HEADSET KIT CR BIKES
	1 HEADSET	1194001	PUS105	FSA NO.85 1.5" 0MM OFFSET OVAL CUPS STAINLESS
		1814053	ZCA013	OFFSET HEADSET KIT AL BIKES
	1 HEADSET	1194003	PUS105	FSA ZS56 66 0MM OFFSET HS STAINLESS STEEL

WARRANTY INFORMATION

Your bicycle is warranted against defects in materials and manufacturing as per the following table:

CATEGORY	TERM	NOTES
Frame members	5 years	Front triangle + rear triangle, links
Hardware	1 year	Pivots, axles, etc.
Drive wear items	1 year	Pulleys, pinions, transfer chain
Battery	2 years	If stored for 3+ months, charge battery every 3 months. Failure to do so may cause damage.
Components	As per original manufacturer warranty	

All warranty and after-sale service must be handled by the authorized dealer who sold the complete bicycle or frame. We cover your Rocky Mountain frame for defects in material and workmanship from the original date of purchase of your new Rocky Mountain bicycle according to the frame material and the type of use.

Registering your bike is the official way for us to welcome you into the Rocky Mountain family. It's also an important step in activating your bike's warranty. If you ever have an issue, we'll be able to handle your case efficiently and get you back riding as soon as possible. It's easy and only takes a few minutes.

[bikes.com/registration](https://www.rockymountainbikes.com/registration)

Frame material / type of use

- Carbon fibre: 5 years – Limited*
- Aluminum – front and fully suspended: 5 years – Limited*
- Downhill and freeride: 3 years – Limited*

* Please refer to the limitations stated below.

NOTE – Warranty is not valid for:

- The installation of components, parts or accessories that are not originally intended for or compatible with the bicycle (or frame) as sold.
- The purchase of a Rocky Mountain bicycle from an unauthorized dealer.

- The purchase of a Rocky Mountain bicycle or frame from third-party internet sites (such as eBay), no matter what the listing says.
- This limited warranty covers bicycles previously used for commercial activity such as rental (bike park), courier, police, security, etc. against defects in material and workmanship. Hardware, bearings, pivots and bushings are excluded from our warranty policy.

Warranty coverage against other defects in workmanship and materials

- Coating – paint and decals: 1 year
- Full suspension frame hardware, bearings, pivots and bushings*: 1 year
*Links are part of the frame.
- Downhill and freeride frame hardware, suspension: 6 months

What is not covered?

- Normal wear and tear
- Damage or failure caused by accident, misuse, abuse or neglect
- Extreme or improper use of your Rocky Mountain bicycle outside of its intended purpose
- Improper assembly and/or lack of proper maintenance
- Paint fading caused by the effects of ultraviolet light (UV) or outdoor exposure
- Scratches and/or chips in the paint caused by dirt, rocks, road debris, roof rack transport, etc
- Components, parts or accessories not compatible with the bicycle (or frame)
- Damage on pressfit bottom bracket caused by improper service or materials/parts

Details of what is not covered under warranty

- Normal wear and tear on tires, tubes, brakes, gear cables, brake pads, etc. is not covered. Your authorized Rocky Mountain dealer will tell you what these normal maintenance items are.
- Consequential damage or any damage caused by accident, misuse or abuse.
- Improper assembly and/or lack of proper maintenance, sandblasting, sanding, grinding, wire brushing, filing, welding, brazing, drilled holes, anodizing, repainting and chrome plating are not covered under your warranty and may void the warranty of the component manufacturers.

- If you ride in extreme terrain, as depicted in mountain biking videos (e.g., by taking "trial"-style riding courses, riding ramps, performing stunts, riding on BMX tracks, riding in the city down stairs and embankments or riding in other similar terrain), you put yourself at great personal risk and forfeit the warranty as outlined in the Warranty Table. It is important to note that bent components, frames, forks, handlebars, seat posts, pedals, cranks and wheel rims are signs of accidents and/or abuse.
- Labour for part replacement or changeover is not included.
- Rocky Mountain Bicycles reserves the right to repair or replace at its discretion any part that is deemed to be covered by a valid warranty.
- Please note that Rocky Mountain Bicycles cannot guarantee a colour match to the original part.
- This warranty extends from the date of purchase, applies only to the original owner, and is not transferable.

EXCLUSION AND LIMITATION OF DAMAGES

THE WARRANTY OF ROCKY MOUNTAIN BICYCLES IS LIMITED TO THE REPAIR OR REPLACEMENT OF THE PRODUCTS AND DOES NOT GRANT ANY WARRANTY, EITHER EXPRESSED OR IMPLIED, LEGAL OR CONVENTIONAL, AND DISCLAIMS ANY AND ALL IMPLIED WARRANTIES OF MERCHANTABILITY AND FITNESS FOR PARTICULAR PURPOSES, AND ROCKY MOUNTAIN SHALL UNDER NO CIRCUMSTANCES BE LIABLE FOR DIRECT OR INDIRECT, SPECIAL, INCIDENTAL OR CONSEQUENTIAL DAMAGES, EVEN WHERE ROCKY MOUNTAIN HAS BEEN ADVISED OF SUCH DAMAGES, AND ROCKY MOUNTAIN'S LIABILITY SHALL BE LIMITED TO \$50.00.

INTRODUCTION

L'Altitude donne une confiance sans pareille. Que vous courriez contre la montre ou contre vos amis la fin de semaine, ce vélo est conçu pour aller vite, pulvériser les descentes et vous aider à tenir des lignes plus difficiles. Ses capacités complètes d'enduro vous aideront non seulement à atteindre le podium, mais aussi à relever de plus gros défis juste pour le plaisir. Avec autant de potentiel entre les mains, on a le goût de repousser ses limites, de grimper plus vite et de se surpasser.

Le présent guide contient de l'information importante sur la sécurité, l'entretien et l'utilisation. Lisez-le attentivement et assurez-vous de bien le comprendre avant d'utiliser votre nouveau vélo Rocky Mountain. Comme il porte uniquement sur la plateforme Altitude, le présent guide sert de complément au manuel d'utilisation inclus avec votre vélo Rocky Mountain. Lisez le manuel d'utilisation avant d'utiliser votre vélo. Si vous n'avez pas le manuel, votre détaillant Rocky Mountain autorisé peut vous le fournir.

ÉTIQUETTE DE LA MONTAGNE

Riders

Faites toujours preuve de courtoisie envers les autres utilisateurs des sentiers. La prudence est particulièrement importante en présence d'animaux domestiques comme des chiens ou des chevaux. Cédez toujours le passage aux autres utilisateurs, en montée comme en descente.

Sentier

Ne roulez que sur des sentiers où l'usage de vélos est permis. Respectez la réglementation locale. Comme tous les utilisateurs, veillez à limiter les répercussions de votre passage sur les sentiers et l'environnement. Évitez les dérapages et ne modifiez pas les sentiers.



SURVOL DE VOTRE VÉLO



CARACTÉRISTIQUES TECHNIQUES

- Le tout nouveau modèle Altitude a été entièrement redessiné pour répartir le poids du vélo vers le bas, augmenter la rigidité de son cadre et améliorer les possibilités de réglage pour offrir un confort optimal à tous les riders, sans oublier ses nouvelles caractéristiques techniques qui le distinguent de ses versions précédentes.
- La cinématique LC2R repensée allie sensibilité et soutien accru le long du débattement afin de réduire la fatigue lors des longues épreuves d'enduro.
- Le cadre SM est muni de roues avant et arrière de 27,5 po, tandis que les cadres MD, LG et XL sont équipés de roues de 29 po et peuvent accueillir des roues de tailles différentes (29 po à l'avant et 27,5 po à l'arrière) sans aucune autre pièce nécessaire.
- Grâce au système d'ajustement RIDE-4MC, le rider peut régler la géométrie avec précision et rapidité au moyen d'une simple clé hexagonale.
- Tous les cadres sont équipés de jeux de direction à ajustement précis de la portée. Par défaut, le cadre a un jeu de direction de 0 mm (neutre). Dans la boîte de petites pièces jointe à chaque cadre et vélo complet, il y a un jeu supplémentaire de cuvettes de jeu de direction de 5 mm qui peut être utilisé pour ajuster la portée.
- Notre nouvelle boîte de rangement PenaltyBox 2.0 est étanche et dotée d'un double verrou rigide facile à utiliser. Ne manquez pas le compartiment secret où ajouter un dispositif de localisation, comme un Tile ou un AirTag, pour protéger votre vélo.
- Tous les accessoires se fixent sous le tube horizontal pour augmenter la capacité de rangement. Les cadres LG et XL peuvent également y accueillir une deuxième bouteille d'eau de 620 ml (21 oz).
- Les paliers d'amortisseur à œillet étanches améliorent considérablement la sensibilité aux chocs (compatibles avec les amortisseurs de rechange); tous les paliers du cadre sont protégés pour prévenir la contamination sur les sentiers difficiles ou lors du lavage après randonnée.

SURVOL DE VOTRE VÉLO



CARACTÉRISTIQUES TECHNIQUES

- Notre suspension LC2R comprend un pivot principal concentrique de jeu de pédalier avec une biellette robuste et des roulements surdimensionnés durables.
- Les cadres ont une protection étendue en caoutchouc pour réduire le bruit et empêcher l'abrasion par contact.
- Tous les modèles comprennent un guide-chaîne OneUp intégré et le support ISCG05 à deux vis, qui permettent d'installer un protège-plateau pour garder votre chaîne en place et votre plateau intact.
- Peu importe la taille, les cadres peuvent accueillir les bouteilles d'eau de format LG (21 oz/600 ml) au moins.

GÉOMÉTRIE ET TAILLES

L'Altitude se décline en cadres de taille précise comportant de nombreux éléments qui améliorent l'ajustement et la géométrie pour chaque rider.

Taille des roues

- Le cadre SM est équipé de roues de 27,5 po à l'avant et à l'arrière.
- Les cadres MD, LG et XL sont équipés de roues de 29 po à l'avant et à l'arrière, mais peuvent aussi accueillir des roues de taille différente (configuration « Mullet » MX).
- Pour changer de configuration, il suffit d'ajuster la position de la plaque située sur la biellette inférieure de l'amortisseur.

Position 29 po



Position MX (27,5 po)



Axe central arrière (parfois appelé longueur de la base)

- Chaque taille de cadre possède un triangle arrière unique (sauf les cadres LG et XL, où il est identique). Pour en savoir plus, consulter le tableau de géométrie. Les triangles arrière des cadres MD, LG et XL sont interchangeables; vous pouvez les échanger pour expérimenter avec différentes longueurs de base.

Jeux de direction à ajustement de la portée

- Tous les cadres sont équipés de jeux de direction à ajustement précis de la portée. Par défaut, le cadre a un jeu de direction de 0 mm (neutre). Dans la boîte de petites pièces jointe à chaque cadre et vélo complet, il y a un jeu supplémentaire de cuvettes de jeu de direction de 5 mm qui peut être utilisé pour ajuster la portée. Lorsque vous consultez le tableau des géométries avec les cuvettes décentrées de 5 mm installées, il vous suffit d'ajouter ou de soustraire 5 mm aux mesures de portée, de longueur du tube supérieur et d'empattement pour les faire correspondre à l'orientation des cuvettes. Pour les instructions d'installation, consulter la section « Caractéristiques du cadre ».

Jeu de direction de 0 mm – carbone



Jeu de direction de 5 mm – carbone



Jeu de direction de 0 mm – alliage



Jeu de direction de 5 mm – alliage

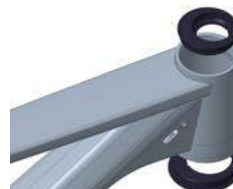

GÉOMÉTRIE ET TAILLES

Ride-4

Grâce au système d'ajustement RIDE-4MC, le rider peut régler la géométrie avec précision et rapidité au moyen d'une simple clé hexagonale de 6 mm. Ce système est muni de deux plaques pivotantes permettant quatre configurations. Consulter le tableau des géométries pour savoir comment chaque position modifie la géométrie. Pour les instructions d'ajustement, consulter la section « Caractéristiques du cadre ».

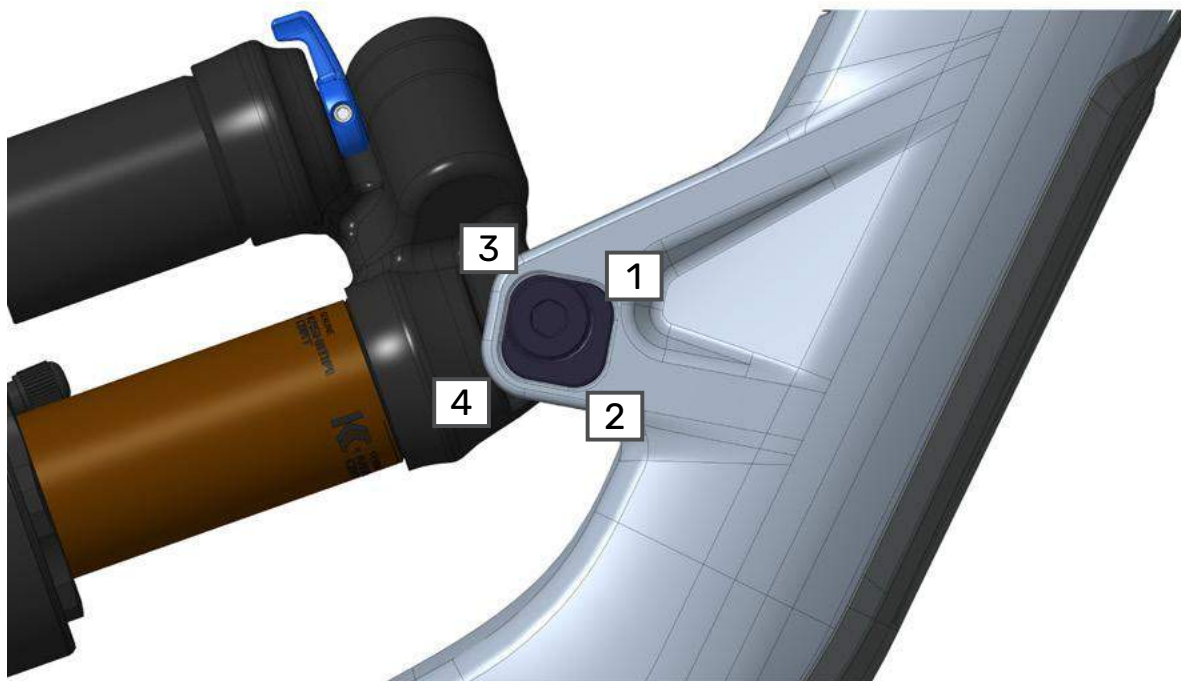

GÉOMÉTRIE ET TAILLES

Taille de cadre

Ce tableau est fourni à titre indicatif seulement. Pour choisir la bonne taille de vélo, il faut aussi tenir compte des proportions, du style de conduite et des préférences personnelles du rider. En général, les vélos à courte portée sont plus dynamiques et animés. Les vélos plus longs sont plus stables et plus discrets. Rocky Mountain recommande toujours d'essayer le vélo et de le faire ajuster par un professionnel chez un détaillant autorisé.

CM	152.5	155	157.5	160	162.5	165	167.5	170	172.5	175	177.5	180	183	185.5	188	190.5	193	195.5	198
FT-IN	5'0"	5'1"	5'2"	5'3"	5'4"	5'5"	5'6"	5'7"	5'8"	5'9"	5'10"	5'11"	6'	6'1"	6'2"	6'3"	6'4"	6'5"	6'6"
	SM				MD				LG				XL						
SM																			
MD																			
LG																			
XL																			
CM	152.5	155	157.5	160	162.5	165	167.5	170	172.5	175	177.5	180	183	185.5	188	190.5	193	195.5	198
FT-IN	5'0"	5'1"	5'2"	5'3"	5'4"	5'5"	5'6"	5'7"	5'8"	5'9"	5'10"	5'11"	6'	6'1"	6'2"	6'3"	6'4"	6'5"	6'6"
	SM				MD				LG				XL						
SM																			
MD																			
LG																			

Tableau de géométrie

TAILLE DE CADRE	SM	MD	LG	XL	MD	LG	XL
Taille des roues	27.5		29			MX	
Angle du tube de direction(deg)	63	63	63	63	62,9	62,9	62,9
Angle du tube de selle (deg)	77	77	77	77	77	77	77
Longeur du tube de selle (mm)	365	410	440	470	410	440	470
Longeur du tube horizontal (mm)	553	584	610	642	584	610	642
Longeur du tube de direction (mm)	100	105	115	130	105	115	130
Longeur de la base arrière (mm)	430	440	450	450	440	450	450
Hauteur du boîtier de pédalier (mm)	24	38	38	38	29	29	29
Hauteur de surplomb (mm)	760	792	798	809	791	797	808
Empattement (mm)	1189	1244	1283	1319	1243	1282	1319
Portée (mm)	424	450	475	505	450	475	505
Élévation (mm)	599	630	639	653	630	639	653

GÉOMÉTRIE ET TAILLES

TAILLE DE CADRE Taille des roues	SM 27.5	MD	LG 29	XL	MD	LG MX	XL
Angle du tube de direction(deg)	63,3	63,3	63,3	63,3	63,2	63,2	63,2
Angle du tube de selle (deg)	77,3	77,3	77,3	77,3	77,2	77,2	77,2
Longeur du tube de selle (mm)	365	410	440	470	410	440	470
Longeur du tube horizontal (mm)	553	584	610	642	584	610	642
Longeur du tube de diection (mm)	100	105	115	130	105	115	130
Longeur de la base arrière (mm)	430	440	450	450	440	450	450
Hauteur du boîtier de pédalier (mm)	20	34	34	34	25	25	25
Hauteur de surplomb (mm)	763	794	801	812	793	801	812
Empattement (mm)	1189	1243	1283	1319	1242	1282	1318
Portée (mm)	427	453	478	508	453	478	508
Élévation (mm)	599	630	639	653	630	639	653
Angle du tube de direction(deg)	63,5	63,5	63,5	63,5	63,4	63,4	63,4
Angle du tube de selle (deg)	77,5	77,5	77,5	77,5	77,4	77,4	77,4
Longeur du tube de selle (mm)	365	410	440	470	410	440	470
Longeur du tube horizontal (mm)	553	584	610	642	584	610	642
Longeur du tube de diection (mm)	100	105	115	130	105	115	130
Longeur de la base arrière (mm)	430	440	450	450	440	450	450
Hauteur du boîtier de pédalier (mm)	17	31	31	31	22	22	22
Hauteur de surplomb (mm)	765	796	803	814	796	803	814
Empattement (mm)	1188	1243	1282	1319	1242	1281	1318
Portée (mm)	430	455	480	510	455	480	510
Élévation (mm)	599	630	639	653	630	639	653
Angle du tube de direction(deg)	63,8	63,8	63,8	63,8	63,7	63,7	63,7
Angle du tube de selle (deg)	77,8	77,8	77,8	77,8	77,7	77,7	77,7
Longeur du tube de selle (mm)	365	410	440	470	410	440	470
Longeur du tube horizontal (mm)	553	584	610	642	584	610	642
Longeur du tube de diection (mm)	100	105	115	130	105	115	130
Longeur de la base arrière (mm)	430	440	450	450	440	450	450
Hauteur du boîtier de pédalier (mm)	13	27	27	27	18	18	18
Hauteur de surplomb (mm)	768	798	806	817	798	806	817
Empattement (mm)	1188	1242	1282	1319	1241	1281	1317
Portée (mm)	433	458	483	513	458	483	513
Élévation (mm)	599	630	640	653	630	639	653

GÉOMÉTRIE ET TAILLES

Ajustement de la tige de selle télescopique

Vous trouverez ci-dessous le guide des principales dimensions et mesures pour la configuration de la tige du fabricant ainsi que certaines des options possibles si une tige de selle télescopique de rechange est installée. Le tableau montre l'ajustement de la tige de selle avec le débattement complètement allongé. Cela permet de déterminer la position la plus basse ou la plus haute à laquelle la tige de selle peut être réglée pour obtenir la bonne hauteur en position assise de pédalage. Le tableau vous aidera également à déterminer la taille de la tige de selle à installer si celle du fabricant ne correspond pas à la taille souhaitée. Veuillez noter que la dimension indiquée est celle qui va du centre du jeu de pédalier au sommet de la selle du fabricant. La longueur du pédalier peut affecter l'ajustement du siège et doit également être prise en compte en cas de changement de ce composant.

Utilisation du tableau

1. Mesurez la hauteur actuelle de votre selle depuis le centre du jeu de pédalier jusqu'au sommet de la selle, juste au-dessus de la tige de selle.
2. Choisissez le modèle de tige désiré, le débattement de la tige et le cadre.
3. Veillez à ce que votre mesure se situe entre les longueurs d'insertion minimale et maximale indiquées dans le tableau.

Exemple : J'ai mesuré 795 mm sur mon vélo actuel. Si je choisis le modèle OneUp V3, avec un débattement de 210 mm, sur un cadre LG en carbone, selon le tableau, je peux utiliser cette combinaison de débattement et de taille de cadre puisque les mesures minimale et maximale possibles sont de 735 mm et 860 mm.

MODÈLE DE TIGE	DÉBATTEMENT DE LA TIGE	TAILLE DE CADRE	CARBON				ALLOY			
			SM	MD	LG	XL	SM	MD	LG	XL
X Fusion Manic		Longueur du tube de selle	365	410	440	470	365	410	440	470
		Insertion minimale	100	100	100	100	100	100	100	100
		Insertion maximale	212	260	290	320	192	240	270	300
	150	Hauteur minimale de la selle	661	658	685	715	681	678	685	715
	150	Hauteur maximale de la selle	735	780	810	840	735	780	810	840
	170	Hauteur minimale de la selle	705	702	705	735	725	722	722	735
	170	Hauteur maximale de la selle	749	794	824	854	749	794	824	854
	200	Hauteur minimale de la selle	770	767	767	767	790	787	787	787
	200	Hauteur maximale de la selle	794	839	869	899	794	839	869	899
	200	Hauteur minimale de la selle	732	737	737	766	772	747	777	807
200	Hauteur maximale de la selle	794	839	869	899	794	839	869	899	
2020- 2024	150	Hauteur minimale de la selle	644	643	673	703	664	661	673	703
	150	Hauteur maximale de la selle	728	773	803	833	728	773	803	833
	175	Hauteur minimale de la selle	701	698	698	728	721	718	718	728
	175	Hauteur maximale de la selle	785	830	860	890	785	830	860	890
Race Face Turbine R	200	Hauteur minimale de la selle	757	754	754	754	777	774	774	774
	200	Hauteur maximale de la selle	791	836	866	896	791	836	866	896
Fox Transfer	200	Hauteur minimale de la selle	719	724	724	754	759	734	764	794
	200	Hauteur maximale de la selle	791	836	866	896	791	836	866	896

GÉOMÉTRIE ET TAILLES

MODÈLE DE TIGE	DÉBATTEMENT DE LA TIGE	TAILLE DE CADRE	CARBON				ALLOY			
			SM	MD	LG	XL	SM	MD	LG	XL
Reverb AXS *insertion minimale de 80 mm, mais le cadre nécessite 100 mm	150	Hauteur minimale de la selle	661	670	700	730	681	678	700	730
	150	Hauteur maximale de la selle	750	795	825	855	750	795	825	855
	170	Hauteur minimale de la selle	701	698	720	750	721	718	720	750
	170	Hauteur maximale de la selle	790	835	865	895	790	835	865	895
OneUp V2 Dropper * Le débattement est réglable et peut être réduit jusqu'à 20 mm, par intervalles de 10 mm.	150	Hauteur minimale de la selle	618	638	668	698	638	638	668	698
	150	Hauteur maximale de la selle	725	770	800	830	725	770	800	830
	180	Hauteur minimale de la selle	678	675	698	728	698	695	698	728
	180	Hauteur maximale de la selle	755	800	830	860	755	800	830	860
	210	Hauteur minimale de la selle	738	735	735	758	758	755	755	758
	210	Hauteur maximale de la selle	785	830	860	890	785	830	860	890
	240	Hauteur minimale de la selle	808	805	805	805	828	825	825	825
	240	Hauteur maximale de la selle	815	860	890	920	815	860	890	920
BikeYoke Divine 3 * Le débattement est réglable et peut être réduit jusqu'à 30 mm, en fonction de l'option de débattement, par intervalles de 5 mm.	160	Hauteur minimale de la selle	649	652	682	712	669	666	682	712
	160	Hauteur maximale de la selle	740	785	815	845	740	785	815	845
	185	Hauteur minimale de la selle	699	696	707	737	719	716	716	737
	185	Hauteur maximale de la selle	790	835	865	895	790	835	865	895
	213	Hauteur minimale de la selle	764	761	761	765	784	781	781	781
	213	Hauteur maximale de la selle	825	870	900	930	825	870	900	930

SPÉCIFICATIONS ET DIMENSIONS

Caractéristiques du cadre

Pivot principal concentrique du jeu de pédalier

Le jeu de pédalier du nouveau modèle est équipé d'un pivot principal concentrique qui nécessite un outil spécial pour le montage et le démontage. Cet outil (article : 59; numéro de pièce : 1804039) se trouve dans la boîte de petites pièces fournie avec chaque vélo et cadre pour vous permettre d'effectuer le montage vous-même. N'oubliez pas de fournir l'outil à votre centre de service si vous faites appel à quelqu'un d'autre pour l'entretien du pivot. La valeur du couple de serrage au montage (25 N m) est indiquée sur l'outil pour vous aider à assembler le pivot correctement.

Vue éclatée du maillon inférieur

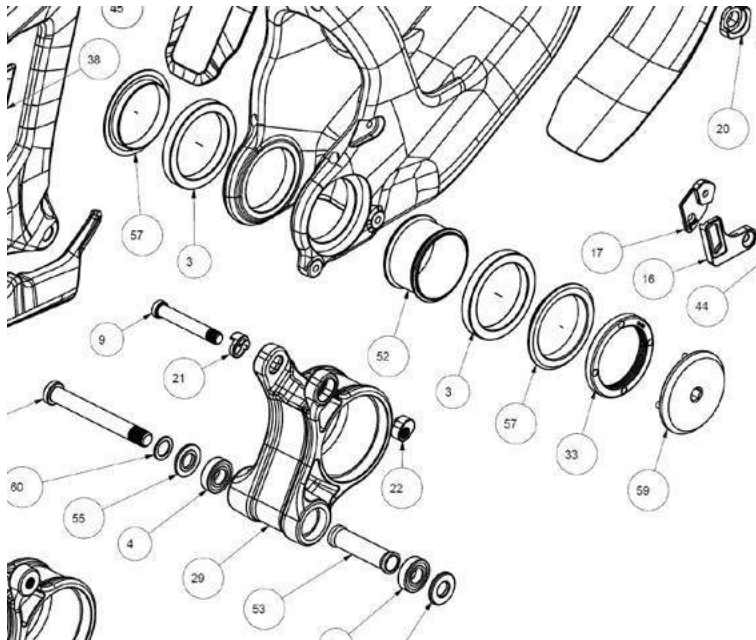

Le pivot principal est fixé au cadre pour empêcher sa rotation pendant l'assemblage. Un petit jeu est acceptable entre l'interface de l'axe du pivot principal et le cadre. Le pivot ne sera solidement fixé qu'une fois l'écrou de blocage correctement serré.



SPÉCIFICATIONS ET DIMENSIONS

Jeu de direction à ajustement de la portée

Tous les cadres sont équipés de jeux de direction à ajustement précis de la portée. Par défaut, le cadre a un jeu de direction de 0 mm (neutre). Dans la boîte de petites pièces jointe à chaque cadre et vélo complet, il y a un jeu supplémentaire de cuvettes de jeu de direction de 5 mm qui peut être utilisé pour ajuster la portée.

Le cadre Altitude en carbone utilise des cuvettes de jeu de direction ovales de style déposées. Aucun outil n'est nécessaire pour retirer et installer les cuvettes dans le cadre. L'alignement des cuvettes se fait automatiquement grâce à la forme ovale et moulée des cuvettes et du tube de direction. Les cuvettes sont dotées d'un joint torique intégré autour de l'extérieur pour les maintenir en place dans le cadre et réduire les mouvements pouvant entraîner du bruit. Les jeux de direction pour les cadres en carbone sont fabriqués par FSA et sont de modèle no 85-1. Ils utilisent des pièces d'assemblage FSA standard, comme des roulements et des cuvettes de direction, pour un remplacement sans tracas des pièces exposées à l'usure.

Le cadre Altitude en alliage utilise des cuvettes de jeu de direction surdimensionnées de style à pression. Il faut des outils spécialisés pour jeu de direction afin d'installer les cuvettes dans le cadre et les en retirer. L'alignement des bagues doit se faire avec précision en raison de la forme non moulée des cuvettes et du tube de direction. Les cuvettes portent un repère d'alignement sur leur face extérieure. Le moyen le plus simple de s'assurer que les cuvettes sont correctement alignées est de placer une longue règle droite le long de ce repère et de la longueur du tube horizontal (cuvette supérieure) ou du tube diagonal (cuvette inférieure). Les jeux de direction pour les cadres en alliage sont fabriqués par FSA et sont de modèle HS-RM-01. Ils utilisent des pièces d'assemblage FSA standard, comme des roulements et des cuvettes de direction, pour un remplacement sans tracas des pièces exposées à l'usure.

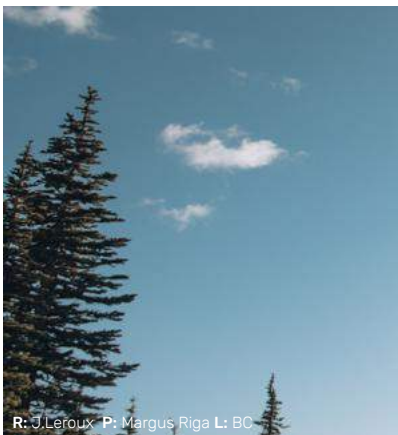

R: J.Leroux P: Margus Riga L: BC



SPÉCIFICATIONS ET DIMENSIONS

Assemblage du jeu de direction du cadre Altitude en carbone

NUMÉRO DE PRODUIT	QTÉ	PIÈCE	NUMÉRO DE PIÈCE	DESCRIPTION
N/A	N/A	Jeu de direction	H0504H0000EK01	Jeu de direction FSA no 85-1, déport de 0 mm, complet
N/A	N/A	Ensemble de cuvettes de jeu de direction	H4204G00ZZE900	Cuvettes FSA, no 85-1, déport de 5 mm, seulement
1	1	Joint torique en caoutchouc	MS053 (872)	Joint torique en caoutchouc, intérieur du capuchon
2	1	Capuchon	H2051A	Capuchon FSA de 5,3 mm
3	1	Joint d'étanchéité en caoutchouc	MS073	Joint d'étanchéité en caoutchouc, extérieur du capuchon
4	1	Cuvette de direction avec fente	H2036 (No.5-2)	Cuvette de compression pour jeu de direction FSA de 1 1/8 po
5	1	Roulement	MR054S	Roulement FSA inoxydable ACB de 1 1/8 po, 36° x 45°
6	1	Cuvette supérieure	H4205A	Cuvette supérieure FSA, déport de 0 mm
	1	Cuvette supérieure	H4204	Cuvette supérieure FSA, déport de 5 mm
7	1	Joint torique en caoutchouc	MS399	Joint torique de la cuvette supérieure
8	1	Joint torique en caoutchouc	MS406	Joint torique de la cuvette inférieure
9	1	Cuvette inférieure	H5145A	Cuvette inférieure FSA, déport de 0 mm
	1	Cuvette inférieure	H5144	Cuvette inférieure FSA, déport de 5 mm
10	1	Roulement	MR110S	Roulement FSA inoxydable ACB de 1,5 po, 36° x 45°
11	1	Couronne de direction	H6083 (No.42)ACB-6)	Couronne de direction FSA de 1,5 po

Assemblage du jeu de direction du cadre Altitude en alliage

NUMÉRO DE PRODUIT	QTÉ	PIÈCE	NUMÉRO DE PIÈCE	DESCRIPTION
N/A	N/A	Jeu de direction	H066500000E101	Jeu de direction FSA RMB ZS56 66, déport de 0 mm, complet
N/A	N/A	Ensemble de cuvettes de jeu de direction	H4214A00ZZE100	Cuvettes FSA RMB ZS56 66, déport de 5 mm, seulement
1	1	Joint torique en caoutchouc	MS053 (872)	Joint torique en caoutchouc, intérieur du capuchon
2	1	Capuchon	H2051A	Capuchon FSA de 5,3 mm
3	1	Joint d'étanchéité en caoutchouc	MS073	Joint d'étanchéité en caoutchouc, extérieur du capuchon
4	1	Cuvette de direction avec fente	H2036 (No.5-2)	Cuvette de compression pour jeu de direction FSA de 1 1/8 po
5	1	Roulement	MR054S	Roulement FSA inoxydable ACB de 1 1/8 po, 36° x 45°
6	1	Cuvette supérieure	H4217	Cuvette supérieure FSA ZS56, déport de 0 mm
	1	Cuvette supérieure	H4214	Cuvette supérieure FSA ZS56, déport de 5 mm
7	1	Cuvette inférieure	H5149	Cuvette inférieure FSA ZS66, déport de 0 mm
	1	Cuvette inférieure	H5148	Cuvette inférieure FSA ZS66, déport de 5 mm
8	1	Roulement	MR110S	Roulement FSA inoxydable ACB de 1,5 po, 36° x 45°
9	1	Couronne de direction	H6083 (No.42)ACB-6)	Couronne de direction FSA de 1,5 po

SPÉCIFICATIONS ET DIMENSIONS

Ride-4

Grâce au système d'ajustement RIDE-4^{MC}, le rider peut régler la géométrie avec précision et rapidité au moyen d'une simple clé hexagonale de 5 mm. Ce système est muni de deux plaques pivotantes permettant quatre configurations. Consulter le tableau des géométries pour savoir comment chaque position modifie la géométrie. Pour les instructions d'ajustement, consulter la section « Caractéristiques du cadre ».

READY FOR ANY TRAIL

The RIDE-4TM adjustment system allows you to quickly fine-tune your geometry and suspension with a single 5-mm Allen key.





Diagram labels:

- Position 1: SLACKER HEAD-TUBE ANGLE, MORE PROGRESSIVE SUSPENSION
- Position 2: SLACKER HEAD-TUBE ANGLE, MORE PROGRESSIVE SUSPENSION
- Position 3: SLACKER HEAD-TUBE ANGLE, MORE PROGRESSIVE SUSPENSION
- Position 4: STEEPER HEAD-TUBE ANGLE, LESS PROGRESSIVE SUSPENSION



Position

 SLACK

The lower bottom bracket and progressive suspension increase stability at higher speeds. Recommended for more aggressive trail riding.

Position 3

 NEUTRAL

This position offers a balanced blend of geometry and suspension performance to cater to a wide variety of trails.

Position 4

 STEEP

The higher bottom bracket and linear suspension allow for better pedal clearance, a more supportive initial suspension rate, and a position on the bike better suited for climbing.

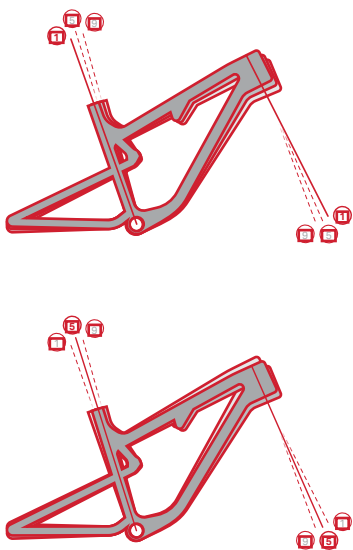

PENALTY BOX 2.0

La version carbone du cadre Altitude 2024 est équipée du tout nouveau rangement Penalty Box 2.0, muni d'une pochette à outils et à chambre à air. Le couvercle est maintenu en place par notre système innovant de fermoir double anti vibration. Pour ouvrir le rangement, il suffit de tirer la languette extérieure. Il n'est pas nécessaire d'enlever la gourde d'eau, mais cela peut faciliter l'accès au besoin. Notez que si la plupart des porte-bidons sont compatibles avec le couvercle de la Penalty Box 2.0, il y en a quelques-uns qui ne le seront pas sans quelques ajustements. Nous vous recommandons de tester l'ajustement de la cage et de vous assurer que le loquet dispose d'une amplitude de mouvement complète pour libérer le couvercle. Dans certains cas, les rondelles installées sous la cage, ainsi que les boulons plus longs requis, créeront suffisamment d'espace pour que le loquet fonctionne.



Sur le couvercle, un compartiment spécial permet d'installer un dispositif de localisation, comme un Tile ou un Airtag. Pour y accéder, retirez les vis et écrous du support à bouteille d'eau sur l'intérieur du couvercle. Ensuite, retirez le boulon hexagonal 2,5 installé sur la même pièce de couvercle et qui sert à fermer le compartiment pour dispositif de localisation. Le compartiment est alors accessible. Pour remettre le couvercle, il suffit d'inverser les instructions de démontage.



CONSEILS CONCERNANT LA POCHETTE À OUTILS (CARBONE SEULEMENT)

Pour faciliter l'insertion et le retrait de la pochette, dégonflez complètement et pliez bien la chambre à air dans la pochette. Veillez à ce que la sangle soit face à l'ouverture pour faciliter le retrait si la pochette descend vers le jeu de pédalier ou monte vers le tube de direction.

Limitez la quantité d'articles dans la pochette pour éviter qu'elle ne soit difficile à insérer ou à sortir. La pochette est conçue pour un petit multioutil, une petite pompe ou cartouche de CO2 et différents petits articles : clés, monnaie, rustines, etc.

SPÉCIFICATIONS ET DIMENSIONS

Configuration MX (« Mullet »)

Le cadre SM est muni de roues avant et arrière de 27,5 po, tandis que les cadres MD, LG et XL sont équipés de roues de 29 po et peuvent accueillir des roues de tailles différentes (29 po à l'avant et 27,5 po à l'arrière) sans aucune autre pièce nécessaire. Pour changer de configuration, il suffit d'ajuster la position de la plaque située sur la biellette inférieure de l'amortisseur. À l'aide d'une clé hexagonale de 5 mm, retirez la vis de l'amortisseur arrière du côté opposé à la transmission et placez la plaque de chaque côté dans la position correspondant à la configuration MX. Pour changer de position, référez-vous au diagramme ci-dessous.

Position MX (27,5 po)



Position 29 po



SUPPORT DE DÉRAILLEUR UNIVERSEL

Votre nouveau cadre est compatible avec le support de dérailleur universel de SRAM. Aucune autre pièce supplémentaire n'est requise pour l'installation.

1.



2.



ŒILLET À ROULEMENTS POUR AMORTISSEUR ET QUINCAILLERIE

Sur le cadre de votre vélo, l'œillet arrière est doté de roulements à cartouche, ce qui améliore la sensibilité aux petits chocs. Ces roulements sont soutenus par des cuvettes très fermement installées dans l'axe de l'amortisseur. Si vous faites entretenir votre amortisseur, nous vous recommandons fortement de retirer ces composants, car les centres d'entretien de la suspension ne peuvent pas garantir leur retour. L'amortisseur avant combine des réducteurs Rocky Mountain (pièce 5) et des pièces fournies par le fabricant. Veuillez consulter le tableau ci-dessous pour obtenir des informations techniques sur la quincaillerie de l'amortisseur, des schémas de référence et des instructions pour retirer le système d'œillet à roulements.

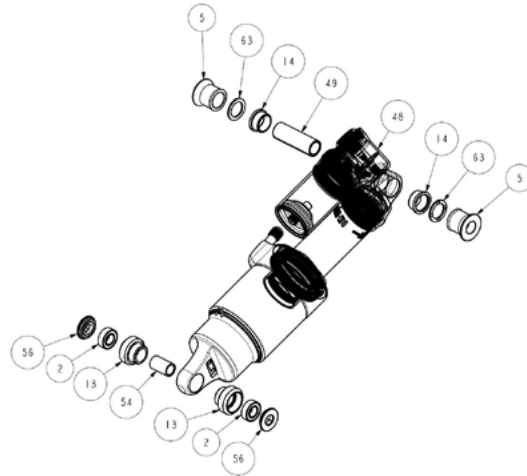

Œillet à roulements pour amortisseur arrière Altitude – 35 x 8 mm (largeur x diamètre de la quincaillerie)

NUMÉRO DE PRODUIT	QTÉ	PIÈCE	NUMÉRO DE PIÈCE	DESCRIPTION
N/A	1	Trousse complète Rocky Mountain	TBD	Trousse d'œillet à roulements pour amortisseur – 8 x 35 mm
2	2	Roulement	1801010	ROULEMENT ENDURO 688 LLU MAX 16 X 8 X 5 MM
13	2	Cuvette de roulement	1800031	ŒILLET À ROULEMENT POUR ROULEMENT DE 16 X 8 X 5 MM
54	1	Douille	1807028	DOUILLE CENTRALE POUR ŒILLET À ROULEMENT
56	2	Entretoise	1804042	ENTRETOISE D'AMORTISSEUR POUR BIELLE INFÉRIEURE, LONGUEUR TRANSVERSALE DE 8 MM

Quincaillerie d'amortisseur avant Altitude – 40 x 10 mm (largeur de l'axe d'amortisseur x diamètre de la quincaillerie)

NUMÉRO DE PRODUIT	QTÉ	PIÈCE	NUMÉRO DE PIÈCE	DESCRIPTION
5	2	Entretoise	1804049	RÉDUCTEUR POUR AMORTISSEUR AVANT, LONGUEUR TRANSVERSALE DE 10 MM
14	2	Bagues Fox	213-01-263	BAGUES EN TEFLON DE ROCK SHOX
	2	Bagues Rock Shox	11.4115.013.000	AXE D'AMORTISSEUR (voir la description de la trousse complète ci-dessous)
49	1	Axe d'amortisseur	N/A	RONDELLE DE COMPRESSION (voir la description de la trousse complète ci-dessous)
63	2	Rondelle d'amortisseur	N/A	Quincaillerie de montage FOX – 9 pièces en acier inoxydable 10 mm x 40/1,575
N/A	1	Trousse complète Fox	803-03-329	*Ne pas utiliser les grandes entretoises en plastique fournies dans la trousse
N/A	1	Trousse complète Rock Shox	N/A	ENSEMBLE D'ENTRETOISE 3 PIÈCES (QUINCAILLERIE) POUR AMORTISSEUR DE 1/2 PO 40,0X10, LARGEUR 3,65
N/A	1	Trousse complète Rock Shox	11.4118.091.005	QUINCAILLERIE ROCK SHOX 10 x 20,0 *Ne pas utiliser l'axe
N/A	1	Trousse complète Rock Shox	11.4118.091.012	QUINCAILLERIE ROCK SHOX 10 x 40,0 *Ne pas utiliser les entretoises

Conseil d'experts : La trousse complète Fox est compatible avec les œillets d'amortisseurs Rock Shox. Retirez la bague de Teflon de l'œillet Rock Shox avant d'installer la trousse Fox.

ŒILLET À ROULEMENTS POUR AMORTISSEUR ET QUINCAILLERIE

Retrait des œillets

Voici comment retirer le système :

- Utilisez la trousse d'outils pour œillets à roulements de Rocky Mountain (pièce 1810031).
- Insérez la goupille d'un côté de l'œillet.
- Fixez ensuite l'un des outils d'extraction sur la cuvette où est insérée la goupille.
- Vissez la vis M8 jusqu'à ce qu'elle soit bien appuyée sur la goupille.
- Fixez l'autre outil d'extraction sur l'autre cuvette.
- Vissez la vis M8 au maximum, jusqu'à ce qu'elle pousse sur la goupille de l'autre côté.
- Continuez à visser jusqu'à ce que l'une des cuvettes soit entièrement extraite.
- Insérez ensuite le poinçon dans l'œillet en l'appuyant solidement sur la cuvette qui est toujours dans l'œillet.
- Avec un marteau, frappez doucement mais fermement sur le poinçon jusqu'à ce que la cuvette soit entièrement extraite de l'œillet.

If you do not have the Rocky Mountain Bearing Eyelet Tool Kit, use a blind bearing puller:

- Avec l'extracteur (embout de 8 mm), retirez les deux roulements. Insérez la goupille d'un côté de l'œillet.
- Retirez la douille centrale.
- Avec l'extracteur (embout de 10 mm), retirez les cuvettes vides.

N.B. : Le diamètre intérieur des cuvettes est de 11 mm, et donc trop petit pour l'embout de 12 mm. Ne le forcez pas. Utilisez plutôt l'embout de 10 mm.

Installez de nouvelles cuvettes avec une presse à roulement ou un étau à mordaches en veillant à appuyer sur le bord extérieur des cuvettes. N'oubliez pas la douille-entretoise entre les cuvettes.

CONFIGURATION DE LA SUSPENSION

Avant de modifier les réglages de l'amortisseur, il est important de s'informer sur les différents réglages possibles.

Réglage du ressort

En fonction du modèle d'amortisseur, il se peut que vous deviez ajuster la pression d'air ou la tension du ressort pour obtenir l'affaissement recommandé pour l'Altitude. Consultez le tableau des ressorts ci-dessous pour obtenir des recommandations.

Rebond

Le réglage du rebond contrôle la vitesse à laquelle la suspension revient en pleine extension après un choc. Si le contrôle du rebond est trop serré, la fourche ou l'amortisseur se déplacera trop lentement et s'enfoncera de plus en plus dans son débattement à chaque coup, ce qui donnera une sensation de raideur. S'il est trop léger, la suspension peut rebondir trop vite et causer une perte de traction et de contrôle.

- Le rebond lent fait référence à une faible vitesse de la fourche ou de l'amortisseur, et non à la vitesse sur le sentier. Cet ajustement affecte le taux de rebond dans la première partie du débattement. Pour chiffrer la chose, on parlera de la plage entre 0 et 40 % du débattement.
- Le rebond rapide fait référence à la vitesse élevée de la fourche ou de l'amortisseur, et non à la vitesse sur le sentier. Cet ajustement affecte le taux de rebond dans la deuxième partie du débattement. Pour chiffrer la chose, on parlera de la plage entre 40 et 100 % du débattement.

Compression

Le réglage de la compression contrôle la vitesse de déplacement de la suspension dans son débattement lors d'un choc. Si la compression est trop forte, la fourche ou l'amortisseur se déplacera trop lentement et la force de l'impact sera principalement absorbée par le pneu et l'utilisateur. Si elle ne l'est pas assez, la fourche ou l'amortisseur bougera trop vite et la conduite sera pesante et peu réactive.

- La compression lente fait référence à une faible vitesse de la fourche ou de l'amortisseur, et non à la vitesse sur le sentier. Elle résiste aux déplacements de poids de l'utilisateur, aux mouvements de pompage, aux changements de force d'accélération soudains et à d'autres actions lentes. Si elle est trop élevée, la compression lente nuira au confort; si elle ne l'est pas assez, la conduite sera trop souple et peu réactive. La compression lente influence l'ensemble du débattement.
- La compression rapide fait référence à la vitesse élevée de la fourche ou de l'amortisseur, et non à la vitesse sur le sentier. Elle absorbe les gros impacts comme les rochers anguleux et la compression complète. Si elle est trop élevée, la compression rapide nuira au comportement du vélo à grande vitesse sur les sentiers très cahoteux; si elle ne l'est pas assez, l'amortissement ne sera pas suffisant pour les grosses bosses et le débattement risque d'être utilisé au complet.

Amortisseur hydraulique

L'amortisseur hydraulique fait référence à la résistance à la compression complète que certains amortisseurs peuvent exercer en combinaison avec un dispositif de réglage externe. Cela affecte les derniers 20 % du débattement de l'amortisseur et est utilisé en cas de chocs importants où le vélo risque d'atteindre sa limite d'amortissement.

Veillez consulter les tableaux ci-dessous pour connaître toutes les configurations de l'amortisseur d'origine pour l'Altitude. En raison du grand nombre d'amortisseurs compatibles avec l'Altitude, nous ne pouvons pas fournir de guides de configuration pour les modèles autres que ceux du fabricant.

CONFIGURATION DE LA SUSPENSION

Lorsque vous ajustez la suspension, prenez note de vos réglages. Pourquoi ne pas utiliser un tableur en ligne sur votre téléphone?

Le retrait de l'amortisseur sur l'Altitude avec sa suspension LC2R peut nécessiter quelques étapes supplémentaires. Voici la marche à suivre. Pour l'installation, suivez les étapes en sens inverse. N'oubliez pas de noter les valeurs de couple données dans la liste des petites pièces, qui se trouve dans le fichier PDF de la vue explosée.

1. Passer au petit pignon de la cassette et bloquer la cage du dérailleur en position ouverte si possible.
2. Retirer la roue.
3. Vérifier que les zones du cadre entre le tube de selle et la biellette sont propres et exemptes de débris.
4. Retirer la vis de l'amortisseur avant.
 - Soutenir le triangle arrière une fois que la quincaillerie de l'amortisseur avant est retirée, et l'étendre doucement vers l'arrière jusqu'à ce que le hauban entre en contact avec le tube de selle.
5. Retirer la vis de l'amortisseur arrière.
 - Si nécessaire, retirer les plaques Ride4 des deux côtés de la biellette.
6. Retirer l'amortisseur
 - Placer une main sous les entretoises des œillets à roulements de chaque côté, car elles tomberont.



CONFIGURATION DE LA SUSPENSION

ALTITUDE 2024 - AMORTISSEUR À RESSORTS DHX2 DE FOX

DIMENSIONS DE L'AMORTISSEUR SM = 210 X 55 MM - MD À XL = 230 X 60 MM
 RÉGLAGE DE L'AMORTISSEUR CX001, JCR010, REZI BX001
 NOTES *CLICS À PARTIR DE LA POSITION FERMÉE : 0 CLIC = POSITION FERMÉE*

POIDS DE L'UTILISATEUR	RESSORT EN ACIER	RESSORT SLS DE FOX	AFFAISSEMENT DE L'AMORTISSEUR	REBOND LENT	REBOND RAPIDE	COMPRESSION LENTE	COMPRESSION RAPIDE
100lbs 45kg	300	275		10-11	6-7	14-15	6-7
110lbs 50kg	300	300		9--11	6-7	14-15	6-7
120lbs 55kg	350	325		8-9	6-7	14-15	6-7
130lbs 59kg	350	350		8-10	6-7	13-14	6-7
140lbs 64kg	400 (SM)	375		6-7	5-6	12-13	5-6
150lbs 68kg	400	400		6-7	5-7	11-13	5-6
160lbs 73kg	450 (MD)	425	SM 16 - 19mm	5-6	4-5	9-10	5-6
170lbs 77kg	450	450		5-6	4-5	9-11	4-6
180lbs 82kg	500 (LG)	475	MD - XL 19 - 21mm	4-5	4-5	9-10	4-5
190lbs 86kg	500	500		4-5	3-5	7-9	3-4
200lbs 91kg	550 (XL)	525		3-4	3-4	6-7	3-4
210lbs 95kg	600	550		2-3	2-3	5-6	2-3
220lbs 100kg	600			2-3	2-3	5-6	2-3
230lbs 105kg	650			1-2	1-2	4-5	1-2
240lbs 109kg	700	Non offert		1-2	0-1	3-4	0-1
250lbs 114kg	700			1-2	0-1	3-4	0-1

ALTITUDE 2024 - AMORTISSEUR À RESSORTS DHX DE FOX

DIMENSIONS DE L'AMORTISSEUR SM = 210 X 55 MM - MD À XL = 230 X 60 MM
 RÉGLAGE DE L'AMORTISSEUR CMSSB027, RF, REZI BVMLHB03LM
 NOTES *CLICS À PARTIR DE LA POSITION FERMÉE : 0 CLIC = POSITION FERMÉE*

POIDS DE L'UTILISATEUR	RESSORT EN ACIER	RESSORT SLS DE FOX	AFFAISSEMENT DE L'AMORTISSEUR	REBOND LENT	REBOND RAPIDE	COMPRESSION LENTE	COMPRESSION RAPIDE
100lbs 45kg	300	275		10		9 - Open	
110lbs 50kg	300	300		10		9	
120lbs 55kg	350	325		10 - 9		8 - 9	
130lbs 59kg	350	350		9		8	
140lbs 64kg	400 (SM)	375		9 - 8		7 - 8	
150lbs 68kg	400	400		8		7	
160lbs 73kg	450 (MD)	425	SM 16 - 19mm	8 - 7		6 - 7	
170lbs 77kg	450	450		7		6	
180lbs 82kg	500 (LG)	475	MD - XL 19 - 21mm	7 - 6	Non offert	5 - 6	Non offert
190lbs 86kg	500	500		6		5	
200lbs 91kg	550 (XL)	525		6 - 5		4 - 5	
210lbs 95kg	600	550		5		4	
220lbs 100kg	600			5 - 4		3 - 4	
230lbs 105kg	650			4		3	
240lbs 109kg	700	Non offert		4 - 3		2 - 3	
250lbs 114kg	700			3		2	

CONFIGURATION DE LA SUSPENSION

ALTITUDE 2024 – AMORTISSEUR PNEUMATIQUE FLOAT X2 DE FOX

DIMENSIONS DE L'AMORTISSEUR SM = 210 X 55 MM – MD À XL = 230 X 60 MM
 RÉGLAGE DE L'AMORTISSEUR ENTRETOISE 0,3 X1, CX001, JCR010, REZI BX001
 NOTES *CLICS À PARTIR DE LA POSITION FERMÉE : 0 CLIC = POSITION FERMÉE*

POIDS DE L'UTILISATEUR	RESSORT EN ACIER	AFFAISSEMENT DE L'AMORTISSEUR	REBOND LENT	REBOND RAPIDE	COMPRESSION LENTE	COMPRESSION RAPIDE
100lbs 45kg	120psi 8.3bar		11-13	5-6	14-16	6-7
110lbs 50kg	130psi 9bar		10-12	5-6	13-15	6-7
120lbs 55kg	140psi 9.7bar		9-11	4-5	13-15	6-7
130lbs 59kg	150psi 10.3bar		8-10	4-5	12-14	5-6
140lbs 64kg	160psi 11bar		7-9	4-5	11-13	5-6
150lbs 68kg	170psi 11.7bar		7-9	3-4	10-12	5-6
160lbs 73kg	180psi 12.4bar	SM	6-8	3-4	9-11	4-5
170lbs 77kg	190psi 13.1bar	16 - 19mm	6-8	3-4	8-10	4-5
180lbs 82kg	200psi 13.8bar	MD - XL	5-7	2-3	7-9	4-5
190lbs 86kg	210psi 14.5bar	19 - 21mm	4-6	2-3	6-8	4-5
200lbs 91kg	220psi 15.2bar		3-5	2-3	5-7	3-4
210lbs 95kg	230psi 15.9bar		2-4	2-3	4-6	3-4
220lbs 100kg	240psi 16.5bar		2-4	1-2	2-4	3-4
230lbs 105kg	250psi 17.2bar		1-3	1-2	2-4	3-4
240lbs 109kg	260psi 17.9bar		1-3	1-2	2-4	2-3
250lbs 114kg	270psi 18.6bar		1-2	1-2	1-3	1-2

2024 ALTITUDE FOX FLOAT X AIR SHOCK

DIMENSIONS DE L'AMORTISSEUR SM = 210 X 55 MM – MD À XL = 230 X 60 MM
 RÉGLAGE DE L'AMORTISSEUR ENTRETOISE 0,4, CMSSB024, RM, REZI BVMLHB01LM
 NOTES *CLICS À PARTIR DE LA POSITION FERMÉE : 0 CLIC = POSITION FERMÉE*

POIDS DE L'UTILISATEUR	RESSORT EN ACIER	AFFAISSEMENT DE L'AMORTISSEUR	REBOND LENT	REBOND RAPIDE	COMPRESSION LENTE	COMPRESSION RAPIDE
100lbs 45kg	120psi 8.3bar		10		9 - 0pen	
110lbs 50kg	130psi 9bar		10		9	
120lbs 55kg	140psi 9.7bar		10 - 9		8 - 9	
130lbs 59kg	150psi 10.3bar		9		8	
140lbs 64kg	160psi 11bar		9 - 8		7 - 8	
150lbs 68kg	170psi 11.7bar		8		7	
160lbs 73kg	180psi 12.4bar	SM	8 - 7		6 - 7	
170lbs 77kg	190psi 13.1bar	16 - 19mm	7		6	
180lbs 82kg	200psi 13.8bar	MD - XL	7 - 6	Non offert	5 - 6	Non offert
190lbs 86kg	210psi 14.5bar	19 - 21mm	6		5	
200lbs 91kg	220psi 15.2bar		6 - 5		4 - 5	
210lbs 95kg	230psi 15.9bar		5		4	
220lbs 100kg	240psi 16.5bar		5 - 4		3 - 4	
230lbs 105kg	250psi 17.2bar		4		3	
240lbs 109kg	260psi 17.9bar		4 - 3		2 - 3	
250lbs 114kg	270psi 18.6bar		3		2	

CONFIGURATION DE LA SUSPENSION

ALTITUDE 2024 – AMORTISSEUR PNEUMATIQUE SUPER DELUXE DE ROCK SHOX

DIMENSIONS DE L'AMORTISSEUR SM = 210 X 55 MM – MD À XL = 230 X 60 MM

RÉGLAGE DE L'AMORTISSEUR OL1 PRM 32SN

NOTES

CLICS À PARTIR DE LA POSITION FERMÉE : 0 CLIC = POSITION FERMÉE

POIDS DE L'UTILISATEUR	RESSORT EN ACIER	AFFAISSEMENT DE L'AMORTISSEUR	REBOND LENT	REBOND RAPIDE	COMPRESSION LENTE	COMPRESSION RAPIDE
100lbs 45kg	110psi 7.6bar		11-12			
110lbs 50kg	120psi 8.3bar		10-11			
120lbs 55kg	130psi 9bar		9--11			
130lbs 59kg	140psi 9.7bar		8-9			
140lbs 64kg	150psi 10.3bar		8-10	Commencer à la position neutre (position 3)	Commencer à la position neutre (position 3)	Commencer à la position neutre (position 3)
150lbs 68kg	160psi 11bar		6-7	Régler un clic à la fois jusqu'à l'obtention de la résistance voulue à la compression complète.	Régler un clic à la fois jusqu'à l'obtention du soutien voulu aux mouvements de compression basse vitesse (passage sur des rouleaux, tension avant un saut ou un atterrissage, etc.) et dans les montées.	Régler un clic à la fois jusqu'à l'obtention du soutien voulu aux mouvements de compression rapide (rochers anguleux, terrain cahoteux, atterrissages en hauteur, etc.).
160lbs 73kg	170psi 11.7bar	SM	6-7			
170lbs 77kg	180psi 12.4bar	16 - 19mm	5-6			
180lbs 82kg	190psi 13.1bar		5-6	L'amortisseur hydraulique en option entre en action pour limiter le débit d'huile au cours des derniers 20 % du débattement, offrant un coussin hydraulique doux qui réduit la compression.		
190lbs 86kg	200psi 13.8bar	MD - XL	4-5			
200lbs 91kg	210psi 14.5bar	19 - 21mm	4-5			
210lbs 95kg	220psi 15.2bar		3-4			
220lbs 100kg	230psi 15.9bar		2-3			
230lbs 105kg	240psi 16.5bar		2-3			
240lbs 109kg	250psi 17.2bar		1-2			
250lbs 114kg	260psi 17.9bar		1-2			

2024 ALTITUDE ROCK SHOX SUPER DELUXE COIL SHOCK

DIMENSIONS DE L'AMORTISSEUR SM = 210 X 55 MM – MD À XL = 230 X 60 MM

RÉGLAGE DE L'AMORTISSEUR PRM 32SN

NOTES

CLICS À PARTIR DE LA POSITION FERMÉE : 0 CLIC = POSITION FERMÉE LA TENSION DES RESSORTS ROCK SHOX EST 50X PLUS FAIBLE QUE CELLE DES RESSORTS FOX POUR LES CADRES DE MÊME TAILLE. LA DIFFÉRENCE EST DUE AU MODÈLE ET À L'AJUSTEMENT DES AMORTISSEURS ARRIÈRE ROCK SHOX.

POIDS DE L'UTILISATEUR	RESSORT EN ACIER	AFFAISSEMENT DE L'AMORTISSEUR	REBOND LENT	REBOND RAPIDE	COMPRESSION LENTE	COMPRESSION RAPIDE
100lbs 45kg	300		11-12			
110lbs 50kg	300		10-11			
120lbs 55kg	300		9--11			
130lbs 59kg	350		8-9			
140lbs 64kg	350 (SM)		8-10	Commencer à la position neutre (position 3)	Commencer à la position neutre (position 3)	Commencer à la position neutre (position 3)
150lbs 68kg	400		6-7	Régler un clic à la fois jusqu'à l'obtention de la résistance voulue à la compression complète.	Régler un clic à la fois jusqu'à l'obtention du soutien voulu aux mouvements de compression basse vitesse (passage sur des rouleaux, tension avant un saut ou un atterrissage, etc.) et dans les montées.	Régler un clic à la fois jusqu'à l'obtention du soutien voulu aux mouvements de compression rapide (rochers anguleux, terrain cahoteux, atterrissages en hauteur, etc.).
160lbs 73kg	400(MD)	SM	6-7			
170lbs 77kg	450	16 - 19mm	5-6			
180lbs 82kg	450 (LG)		5-6	L'amortisseur hydraulique en option entre en action pour limiter le débit d'huile au cours des derniers 20 % du débattement, offrant un coussin hydraulique doux qui réduit la compression.		
190lbs 86kg	500	MD - XL	4-5			
200lbs 91kg	500 (XL)	19 - 21mm	4-5			
210lbs 95kg	550		3-4			
220lbs 100kg	600		2-3			
230lbs 105kg	600		2-3			
240lbs 109kg	650		1-2			
250lbs 114kg	700		1-2			

PASSAGE DES CÂBLES

Les instructions ci-dessous s'appliquent aux cadres en carbone et en alliage de l'Altitude, mais il y a certaines différences subtiles entre les deux. Attention de bien suivre celles propres à votre cadre.

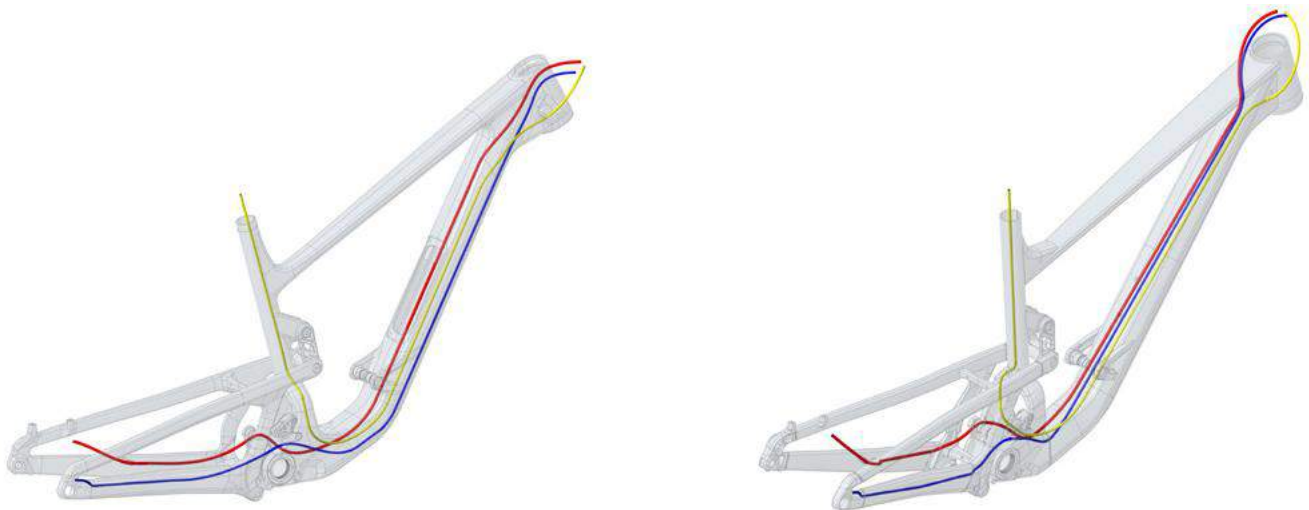

En retirant la roue et l'amortisseur arrière, vous pourrez déplacer le triangle arrière et accéder plus facilement aux câbles se trouvant entre les triangles arrière et avant.

Avec les chambres à air en mousse, les conduits de la base peuvent être serrés, particulièrement les courbures. Vaporisez de l'eau savonneuse ou de l'alcool isopropylique dans l'orifice pour lubrifier le conduit et faciliter le passage des câbles d'un bout à l'autre. N'utilisez pas de graisse ou d'huile; cela laisserait des résidus qui attireraient la saleté.

Le cadre en alliage n'a pas de guides de passage internes. Il faut des outils, comme l'ensemble de passage de câbles internes Park Tool IR-1.2, pour faciliter l'introduction et le retrait de tous les câbles du cadre. Nous recommandons d'installer le fil IR-1.2 à l'envers, en utilisant l'aiguille filetée connectée au nouveau câble et en le tirant doucement vers l'avant du cadre.

REPLACEMENT OU INSTALLATION DU CÂBLE DU DÉRAILLEUR ARRIÈRE

Si vous remplacez un ancien câble, retirez-le et coupez le nouveau câble de la même longueur. Si vous n'avez pas l'ancien câble, évaluez la longueur requise et coupez un segment légèrement plus long.

1. Retirez le protecteur de port du tube de direction du côté

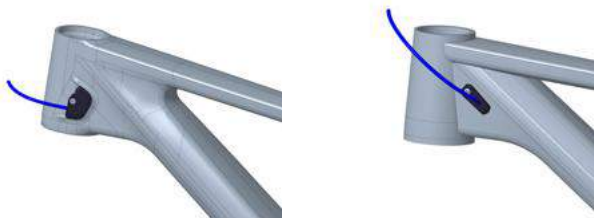

2. En partant de l'arrière du vélo, introduisez le câble dans l'orifice de la base du côté de la transmission. Poussez le câble vers l'avant tout en le faisant tourner jusqu'à ce qu'il ressorte à l'autre extrémité de la base.



3. Introduisez le câble dans le port au-dessus du jeu de pédalier. Le câble du dérailleur doit passer dans le port côté transmission.



4. Poussez sur le câble à partir de l'arrière jusqu'à ce qu'il ressorte du port du tube de direction.

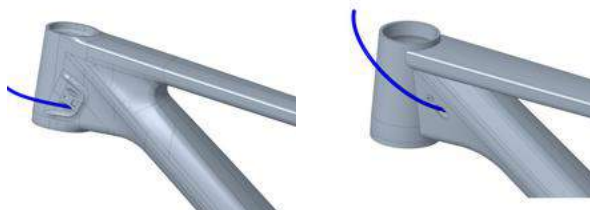

5. Une fois le câble complètement installé entre la manette et le dérailleur arrière, remplacez le protecteur de port du tube de direction. Pour le cadre en alliage, n'oubliez pas d'installer la gaine en mousse de 4 mm incluse. Dans le cas du remplacement de la gaine d'origine, celle-ci pourrait être tombée à l'intérieur du cadre; vous devrez donc l'en extirper.

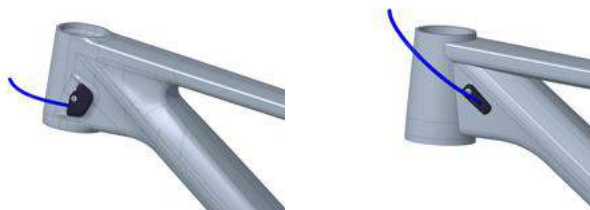

6. Pour le cadre en alliage, assurez-vous d'attacher le câble au support prévu à cet effet sur l'intérieur du tube de l'amortisseur pour éviter tout contact entre le câble et l'amortisseur.



REPLACEMENT OU INSTALLATION DU CÂBLE DE LA TIGE DE SELLE TÉLESCOPIQUE

1. En fonction de l'emplacement du câble de frein arrière, retirez le protecteur de port du tube de direction du côté de la transmission ou opposé à la transmission.



2. Pour le cadre en carbone, en partant du port du tube de direction, introduisez le câble dans l'orifice inférieur. Poussez le câble vers l'avant jusqu'à ce qu'il ressorte du tube de selle.



3. Pour le cadre en alliage, introduisez le câble au niveau de l'ouverture du tube de selle, puis guidez-le dans le port du tube diagonal.



4. Pour le cadre en alliage, poussez le câble jusqu'à ce qu'il ressorte du port de câble au niveau du tube de direction. N'oubliez pas d'installer la gaine en mousse de 4 mm incluse. Dans le cas du remplacement de la gaine d'origine, celle-ci pourrait être tombée à l'intérieur du cadre; vous devrez donc l'en extirper avec précaution.



5. Terminez l'installation de la tige de selle télescopique conformément aux directives du fabricant.

6. Une fois la tige de selle installée, remplacez le protecteur de port du tube de direction.

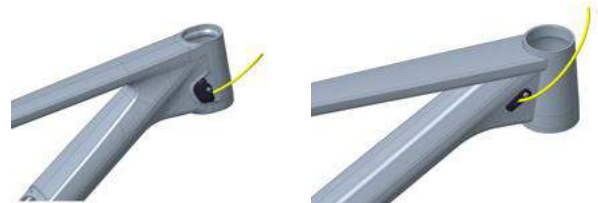

7. Pour le cadre en alliage, assurez-vous d'attacher le câble au support prévu à cet effet sur l'intérieur du tube de l'amortisseur pour éviter tout contact entre le câble et l'amortisseur.



REPLACEMENT OU INSTALLATION DU CÂBLE DE FREIN HYDRAULIQUE ARRIÈRE

1. En fonction de l'emplacement du câble de frein arrière, retirez le protecteur de port du tube de direction du côté de la transmission ou opposé à la transmission.

Passage régulier = Côté opposé à la transmission

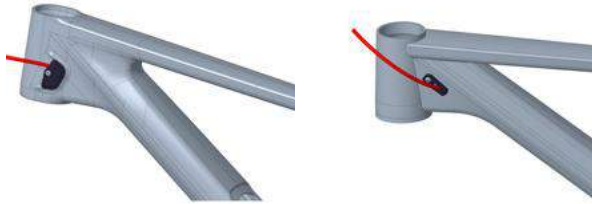

Passage moto | UK-AUS = Côté de la transmission

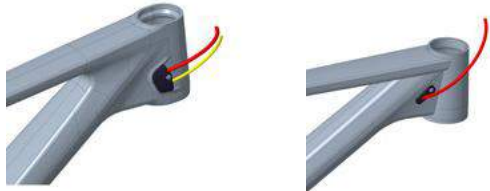

2. Pour le cadre en alliage, retirez le protecteur qui se trouve sur l'intérieur de la base.



3. En commençant par l'arrière du cadre, poussez le câble vers l'avant jusqu'à ce qu'il ressorte à l'autre extrémité de la base.

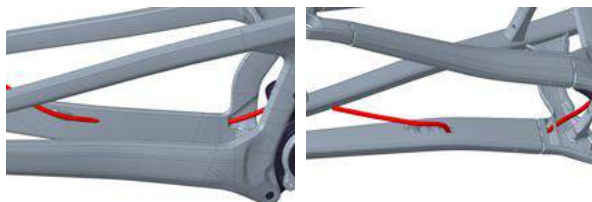

4. Guide the brake hose into the housing port above the bottom bracket. Make sure you insert the brake hose (Red) into the Non-Drive Side port.

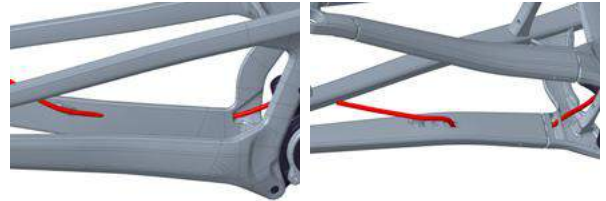

5. Pour le cadre en carbone, retirez le couvercle du rangement Penalty Box pour accéder aux tubes des câbles internes. Au niveau de la partie interrompue du tube, introduisez le câble de frein dans le canal approprié. Le canal inférieur correspond à la position standard du levier de frein arrière. Le câble de frein ressort du côté opposé à la transmission, puis traverse vers le côté droit jusqu'au levier. Le canal supérieur est destiné à la position du levier de frein arrière Moto | UK-AUS (côté gauche).

RegulaPassage régulier = Tube inférieur



Passage moto | UK-AUS = Tube supérieur

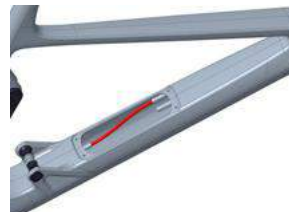

REPLACEMENT OU INSTALLATION DU CÂBLE DE FREIN HYDRAULIQUE ARRIÈRE

6. Poussez sur le câble à partir de l'arrière jusqu'à ce qu'il ressorte du port du tube de direction.

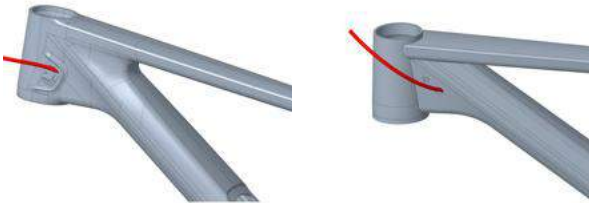

7. Pour le cadre en alliage, poussez le câble jusqu'à ce qu'il ressorte du port au niveau du tube de direction. N'oubliez pas d'installer la gaine en mousse de 5 mm incluse. Dans le cas du remplacement de la gaine d'origine, les tubes en mousse pourraient être tombés dans le cadre; vous devrez donc les en extirper avec précaution.

8. Une fois le câble de frein installé, remettez le protecteur de port du tube de direction.

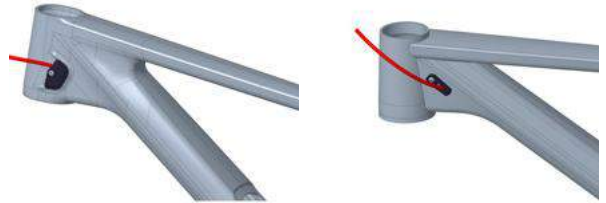

9. Pour le cadre en alliage, assurez-vous d'attacher le câble au support prévu à cet effet sur l'intérieur du tube de l'amortisseur pour éviter tout contact entre le câble et l'amortisseur.

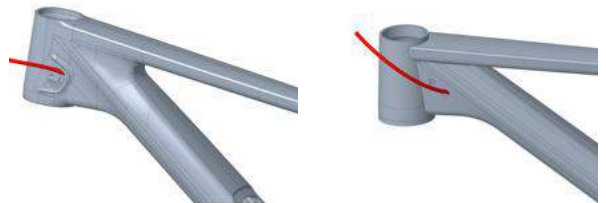

GUIDE DES DIMENSIONS

NUMÉRO DE PRODUIT	CATÉGORIE	PIÈCE	DIMENSIONS	NUMÉRO DE PIÈCE	DESCRIPTION
1	Jeu de direction	Jeu de direction du cadre en carbone	FSA No.85-1 0mm Offset		Jeu de direction FSA no 85-1, déport de 0 mm, complet. Voir le tableau des jeux de direction pour en savoir plus.
		Ensemble de cuvettes de jeu de direction du cadre en carbone	FSA No.85-1 5mm Offset		Cuvettes FSA no 85-1, déport de 5 mm, seulement. Voir le tableau des jeux de direction pour en savoir plus.
		Jeu de direction du cadre en alliage	FSA ZS56 66 0mm Offset		Jeu de direction FSA RMB ZS56 66, déport de 0 mm, complet. Voir le tableau des jeux de direction pour en savoir plus.
		Ensemble de cuvettes de jeu de direction du cadre en alliage	FSA ZS56 66 5mm Offset		Cuvettes FSA RMB ZS56 66, déport de 5 mm, seulement. Voir le tableau des jeux de direction pour en savoir plus.
2	Fourche	Débattement de la fourche	170mm		
		Déport de la fourche	SM = 37mm		
			MD - LG - XL = 42 - 44mm		
		Hauteur maximale entre l'axe et la couronne	SM = 567mm MD - LG - XL = 586mm		
3	Amortisseur	Taille de l'amortisseur	SM = 210 x 55mm MD - LG - XL = 230 x 60mm		Les cadres MD - LG - XL sont compatibles avec 210 x 55 mm.
		Réglage de l'amortisseur	See Description		Voir le tableau de configuration des amortisseurs pour en savoir plus.
		Quincaillerie de l'amortisseur avant	40 x 10mm		Nécessite une quincaillerie personnalisée. Voir le tableau de la quincaillerie de l'amortisseur pour en savoir plus.
		Quincaillerie de l'amortisseur arrière	35 x 8mm	1811007	Nécessite une quincaillerie d'œillet à roulement sur mesure. Voir le tableau de la quincaillerie de l'amortisseur pour en savoir plus.
		Ajustement de l'amortisseur approuvé	See Description		Tous les modèles d'amortisseurs arrière Fox Tous les modèles d'amortisseurs arrière Rock Shox Tous les modèles d'amortisseurs Cane Creek
4	Tige de selle	Diamètre intérieur du tube de selle	30.9mm		Pour déterminer la taille de la tige de selle
		Diamètre extérieur du tube de selle	34.9mm		Pour déterminer la taille du collet de selle
		Insertion minimale du tube de selle	100mm		
		Profondeur d'alésage du tube de selle	SM = 202 192mm MD = 250 240mm		Pour en savoir plus sur l'ajustement de la tige de selle, voir la section sur ce point.
		Carbone Alliage	LG = 280 270mm XL = 310 300mm		

GUIDE DES DIMENSIONS

NUMÉRO DE PRODUIT	CATÉGORIE	PIÈCE	DIMENSIONS	NUMÉRO DE PIÈCE	DESCRIPTION
5	Pédalier	Gamme de tailles de plateau	Minimum = 30 Maximum = 34D		
		Taille de plateau d'origine Longueur de la chaîne	SM = 32 T 116 L		
		Trousse de guide-chaîne	MD = 32 T 118 L		
		Guide-chaîne	LG - XL = 32 T 120 L	TBD	Ensemble complet de guides supérieurs Canadarm 2.0 + OneUp pour Altitude
		Protège-plateau	Consulter la description	IC0686	Pour les pièces individuelles, voir la vue éclatée.
		Jeu de pédalier	2-Bolt ISCG05		Modèle de montage ISCG05 à deux vis compatible avec les protège-plateaux seulement
		Gamme de lignes de chaîne	BSA 73mm		
		Chainline Range	52 - 55mm		
6	Frein	Diamètre de disque maximal	220mm		
		Épaisseur de disque maximal	2.3mm		
7	Roue	Wheel Size	SM = 27.5"		
			MD - LG - XL = 29"		Configuration MX (« Mullet ») possible grâce à une plaque retournée
8	Moyeu arrière	Largeur maximale des pneus	2.5" 63mm		
		Standard de moyeu	12 x 148mm		
		Axe arrière	12 x 1.0 x 173mm		Diamètre de 12 mm x pas de filetage de 1,0 mm x longueur de 173 mm
		Axe de remplacement	See Description	3222000	Diamètre de 12 mm x pas de filetage de 1,0 mm x longueur de 173 mm
		Trousse de support de dérailleur complète	See Description	1812002	Comprend : dérailleur, écrou et rondelle. Pour les pièces individuelles, voir la vue éclatée.
		Support de dérailleur universel Transmission	See Description		Le cadre est compatible avec le support de dérailleur universel et la transmission.

VUE EXPLOSÉE

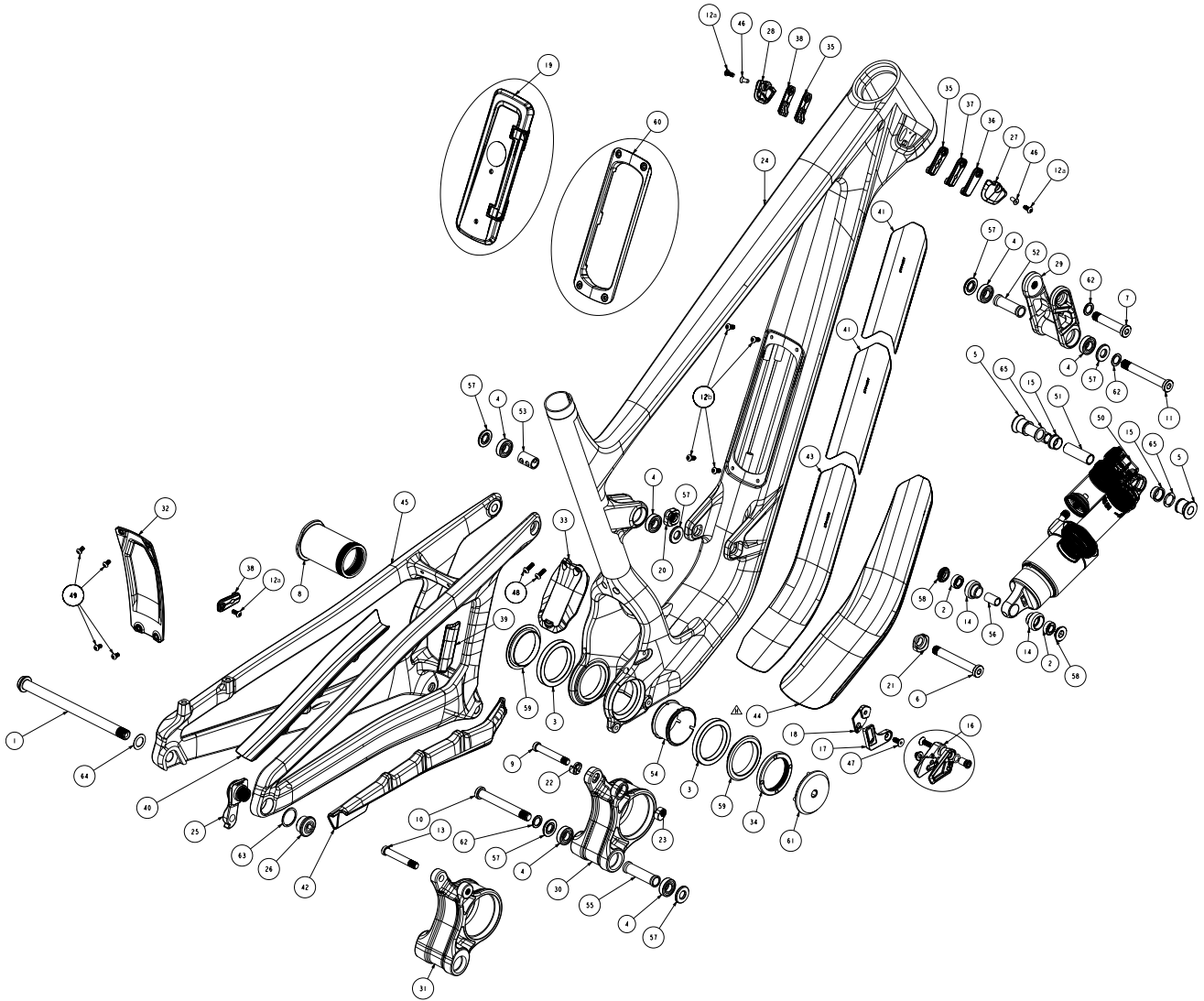

INSTRUCTIONS DE MONTAGE DU CADRE ET LISTES DE PIÈCES

#	QTY	ITEM	PART NO.	INSTALLATION NOTES		
				TORQUE (Nm)	DESCRIPTION	INSTALLATION NOTES
1	1	AXLE, REAR	3222000	10	REAR AXLE 12X1.0 L:173MM, HARD BLACK ANODIZE	Apply grease to axle shaft and threads. Use
2	2	BEARING	1801010		ENDURO 688 LLU MAX 16X8X5	
3	2	BEARING	1804045		24ASPT ALTITUDE MP BEARING 6809 45X58X7	
4	6	BEARING	1807042		ENDURO BEARING 6900 2RS MAX TYPE, 22X10X6 SIZE	
5	2	BEARING SPACER	1804049		FORWARD SHOCK REDUCER 10 MM THRU	
6	1	BOLT	1804033	10	FORWARD SHOCK BOLT, M10x1.0, L:72	Apply grease to pivot bolts, and Loctite 243
7	1	BOLT	1804036	10	TOP LINK, TOP BOLT, M10x1.0, L:51, 6MMHEX	Apply grease to pivot bolts, and Loctite 243
8	1	BOLT	1804037		MAIN PIVOT BOLT (M43x1.5, OD: 43, L:70, ID BSA)	Apply grease to MP bolt and screw threads.
9	1	BOLT	1804040	10	LOWER LINK SHOCK BOLT, M8x1.0, L:51	Apply grease to pivot bolts, and Loctite 243
10	1	BOLT	1804047	10	LOWER LINK LOWER BOLT M10x1.0, L81.5	Apply grease to pivot bolts, and Loctite 243
11	1	BOLT	1804053	10	TOP LINK LOWER BOLT M10x1.0, L74	Apply grease to pivot bolts, and Loctite 243
12	7	BOLT	1804060	< 1	M4x0.7 10MM HEX BUTTON HEAD	a) Apply grease (alloy only). b) Apply Loctite 243 (blue) (carbonyl)
13	1	BOLT	1805169	10	LOWER 27.5 LINK SHOCK BOLT, M8x1.0, L:51, 11 MM THREAD	Apply grease to pivot bolts, and Loctite 243
14	2	BRG CUP	1800031		BEARING EYELET FOR 16x8X5 BRG	
15	2	BUSHING, FOX	N/A		FOX_LIGUS_BUSHING	
16	1	CHAINGUIDE	3391004		ONEUP CHAINGUIDE ASSEMBLY (1C0686)	
17	1	CHAINGUIDE BA	1394003		BASEPLATE FOR CHAINGUIDE	
18	1	CHAINGUIDE SLII	3391002		SLIDING PART OF CHAINGUIDE	
19	1	COMPLETE COVER	1994031		PENALTYBOX 2 COMPLETE COVER SUB-ASSEMBLY	Carbon only.
20	1	FLIP CHIP	1804032		RIDE 4 CHIP - THREADED, M10x1.0, T:10	
21	1	FLIP CHIP	1804034		RIDE 4 CHIP - 10 mm THRU	
22	1	FLIP CHIP	1804041		LOWER LINK FLIP CHIP 29 AND MX	
23	1	FLIP CHIP	1804043		LOWER LINK CHIP THREAD, M8x1.0, 29 OR MX	
24	1	FRONT TRIANGLE	B064112CBN		2024 ALTITUDE CARBON FRONT TRIANGLE - SIZE LARGE	
25	1	HANGER	1092003		MY22 REAR DER. HANGER, M12X1, UDH COMPATIBLE	
26	1	HANGER NUT	1801008	20	RMB UDH HANGER NUT, 7075_T6, HARD BLACK ANODIZED	Apply Loctite 243 (blue) to threads.
27	1	HT PORT COVER	1803012		2023 SLAYER CARBON HT PORT COVER, RIGHT	Carbon only.
28	1	HT PORT COVER	1803013		2023 SLAYER CARBON HT PORT COVER, LEFT	Carbon only.
29	1	LINK	1094001		2024 ALTITUDE TOP LINK	
30	1	LINK	1094002		2024 ALTITUDE LOWER LINK, 29"	Use 1804040 shock bolt with 29/MX link.
31	1	LINK	1094003		MY24 ALTITUDE LOWER LINK, 27.5" SIZE SMALL	Use 1805169 shock bolt for 27.5" link.
32	1	MUD GUARD	1994026		2024 ALTITUDE REAR TRIANGLE MUD GUARD	
33	1	MUD GUARD	1994027		2024 ALTITUDE SHOCK MUD GUARD	
34	1	NUT	1804038	25	MP NUT M43X1.5, T:7, OD:54.5	Install using RMB BB/MP Tool (PART # 1804039).
35	2	PORT COVER	1093011		ALLOY CABLE PORT COVER DOUBLE HOLE	Alloy only.
36	1	PORT COVER	1093012		ALLOY CABLE PORT COVER BLANK	Alloy only.
37	1	PORT COVER	1093013		ALLOY CABLE PORT COVER SINGLE 4mm HOLE	Alloy only.
38	2	PORT COVER	1093014		ALLOY CABLE PORT COVER SINGLE 5mm HOLE	Alloy only.
39	1	PROTECTOR	3704055		2024 ALTITUDE CHAIN STAY UPPER PROTECTOR	
40	1	PROTECTOR	3704056		2024 ALTITUDE SEAT STAY PROTECTOR	
41	2	PROTECTOR	3704057		2024 ALTITUDE TAILGATE PROTECTOR	
42	1	PROTECTOR	3704058		2024 ALTITUDE CHAIN STAY LOWER PROTECTOR	
43	1	PROTECTOR	3704059		2024 ALTITUDE DOWN TUBE PROTECTOR	Alloy
44	1	PROTECTOR	3704108		MY24 ALTITUDE CARBON DOWN TUBE PROTECTOR	Carbon
45	1	REAR TRIANGLE	I054112CBN		2024 ALTITUDE CARBON REAR TRIANGLE - SIZE LARGE & X-LARGE	
46	2	SCREW	1800024-BK	< 1	C'SUNK SOCKET SCREW, M4x10MM, 10.9 STEEL, BLACK	Apply grease to screw threads (carbon only).
47	1	SCREW	1804055	< 2	C'SUNK SOCKET SCREW, M5X0.8, L:12 MM, 3MM HEX, SS	Apply Loctite 243 (blue) to threads.
48	2	SCREW	1804067	< 1	M4x0.7 DOME HEAD SCREW, L:12, HEX 2.5	Apply grease to screw threads.
49	4	SCREW	1804068	< 1	M4x0.7 DOME HEAD SCREW, L:7, HEX 2.5	Apply grease to screw threads.
50	1	SHOCK	N/A		REAR SHOCK, 230X60	
51	1	SHOCK, PIN	N/A		SHOCK PIN: ID:10 MM, L:40 MM, STEEL	
52	1	SLEEVE	1800010		SS BEARING SLEEVE, ID:10, OD:14, L:41, NECKED	
53	1	SLEEVE	1804035		TOP LINK UPPER SLEEVE, OD:14, ID: 10.2, L:22	
54	1	SLEEVE	1804044		MAIN PIVOT SLEEVE L:29 ID:43 OD:49	
55	1	SLEEVE	1804048		LOWER LINK SLEEVE, ID:10.2, OD:14, L:50	
56	1	SLEEVE	1807028		BEARING EYELET CENTRE SLEEVE	
57	6	SPACER	1800009		LINK BEARING SPACER, OD:22, ID:10, T:2.5	
58	2	SPACER	1804042		LOWER LINK SHOCK SPACER, 8 MM THRU	
59	2	SPACER	1804046		MP BEARING SPACER ID:45 OD:57 T:8	
60	1	SUBFRAME S-A	1814004		PENALTYBOX 2 MOUNTING FRAME	Carbon only.
61	1	TOOL	1804039		BOTTOM BRACKET TOOL	BB/MP nut installation tool. Ensure tool is
62	3	WASHER	1800019		WASHER ID: 10.2, OD: 15.5, T: 1	
63	1	WASHER	1801009		WASHER, 20X24X0.5MM, 304 SS	
64	1	WASHER	3227006		WASHER, 12x19x0.5MM, 304 SS	
65	2	WASHER	N/A		SHOCK CRUSH WASHER	
66	1	LINK	1094001P		2024 ALTITUDE TOP LINK POLISHED	
67	1	LINK	1094002P		2024 ALTITUDE LOWER LINK, 29" POLISHED	
68	1	LINK	1094003P		MY24 ALTITUDE LOWER LINK, 27.5" SIZE SMALL POLISHED	
1	1	HEAD SET CUP	1194002		FSA 5MM OFFSET OVAL CUPS W/ORING CR BIKES	
1	1	HEAD SET CUP	1194004		FSA 5MM OFFSET CUPS AL BIKES	
1	1	HEADSET	1194001		FSA NO.85 1.5" OMM OFFSET OVAL CUPS STAINLESS	
1	1	HEADSET	1194003		FSA ZS56 66 OMM OFFSET HS STAINLESS STEEL	

LISTE DES KITS DE PETITES PIÈCES

2024 ALTITUDE CARBON ALLOY					
#	QTY	ITEM	PART NO.	SUPPLIER	REVISION DESCRIPTION
2024 ALTITUDE UPPER LINK KIT WITH BEARINGS					
			1814020	ZCA013	
29	1	LINK	1094001	PTW385	2024 ALTITUDE TOP LINK
4	2	BEARING	1807042	PUS098	ENDURO BEARING 6900 2RS MAX TYPE, 22X10X6 SIZE
52	1	SLEEVE	1800010	PTW047	SS BEARING SLEEVE, ID:10, OD:14, L:41, NECKED
2024 ALTITUDE 29 LOWER LINK KIT WITH BEARINGS					
			1814021	ZCA013	
30	1	LINK	1094002	PTW385	2024 ALTITUDE LOWER LINK, 29"
4	2	BEARING	1807042	PUS098	ENDURO BEARING 6900 2RS MAX TYPE, 22X10X6 SIZE
55	1	SLEEVE	1804048	PTW047	LOWER LINK SLEEVE, ID:10.2, OD:14, L:50
3	2	BEARING	1804045	PUS098	24ASPT ALTITUDE MP BEARING 6809 45X58X7
54	1	SLEEVE	1804044	PTW047	MAIN PIVOT SLEEVE L:29 ID:43 OD:49
2024 ALTITUDE 27.5 LOWER LINK KIT WITH BEARINGS					
			1814022	ZCA013	
31	1	LINK	1094003	PTW385	MY24 ALTITUDE LOWER LINK, 27.5" SIZE SMALL
4	2	BEARING	1807042	PUS098	ENDURO BEARING 6900 2RS MAX TYPE, 22X10X6 SIZE
55	1	SLEEVE	1804048	PTW047	LOWER LINK SLEEVE, ID:10.2, OD:14, L:50
3	2	BEARING	1804045	PUS098	24ASPT ALTITUDE MP BEARING 6809 45X58X7
54	1	SLEEVE	1804044	PTW047	MAIN PIVOT SLEEVE L:29 ID:43 OD:49
2024 ALTITUDE UPPER LINK POLISHED KIT WITH BEARING					
			1814020P	ZCA013	
66	1	LINK	1094001P	PTW385	2024 ALTITUDE TOP LINK POLISHED
4	2	BEARING	1807042	PUS098	ENDURO BEARING 6900 2RS MAX TYPE, 22X10X6 SIZE
52	1	SLEEVE	1800010	PTW047	SS BEARING SLEEVE, ID:10, OD:14, L:41, NECKED
2024 ALTITUDE 29 LOWER LINK POLISHED KT WITH BEARING					
			1814021P	ZCA013	
67	1	LINK	1094002P	PTW385	2024 ALTITUDE LOWER LINK, 29" POLISHED
4	2	BEARING	1807042	PUS098	ENDURO BEARING 6900 2RS MAX TYPE, 22X10X6 SIZE
55	1	SLEEVE	1804048	PTW047	LOWER LINK SLEEVE, ID:10.2, OD:14, L:50
3	2	BEARING	1804045	PUS098	24ASPT ALTITUDE MP BEARING 6809 45X58X7
54	1	SLEEVE	1804044	PTW047	MAIN PIVOT SLEEVE L:29 ID:43 OD:49
2024 ALTITUDE 27.5 LOWER LINK POLISH KT WITH BEARING					
			1814022P	ZCA013	
68	1	LINK	1094003P	PTW385	MY24 ALTITUDE LOWER LINK, 27.5" SIZE SMALL POLISHED
4	2	BEARING	1807042	PUS098	ENDURO BEARING 6900 2RS MAX TYPE, 22X10X6 SIZE
55	1	SLEEVE	1804048	PTW047	LOWER LINK SLEEVE, ID:10.2, OD:14, L:50
3	2	BEARING	1804045	PUS098	24ASPT ALTITUDE MP BEARING 6809 45X58X7
54	1	SLEEVE	1804044	PTW047	MAIN PIVOT SLEEVE L:29 ID:43 OD:49
2022 HANGER KIT 12 x1.0					
			1812002		
25	1	HANGER	1092003	PTW047	MY22 REAR DER. HANGER, M12X1, UDH COMPATIBLE
26	1	HANGER NUT	1801008	PTW047	RMB UDH HANGER NUT, 7075_T6, HARD BLACK ANODIZED
63	1	WASHER	1801009	PTW047	WASHER, 20X24X0.5MM, 304 SS
2024 ALTITUDE PIVOT BOLT KIT					
			1814018	PTW047	
7	1	BOLT	1804036	PTW047	TOP LINK, TOP BOLT, M10x1.0, L:51, 6MMHEX
10	1	BOLT	1804047	PTW047	LOWER LINK LOWER BOLT M10x1.0, L81.5
11	1	BOLT	1804053	PTW047	TOP LINK LOWER BOLT M10x1.0, L74
57	6	SPACER	1800009	PTW047	LINK BEARING SPACER, OD:22, ID:10, T:2.5
62	3	WASHER	1800019	PTW047	WASHER ID: 10.2, OD: 15.5, T: 1
2024 ALTITUDE MAIN PIVOT KIT					
			1814019	PTW047	
8	1	BOLT	1804037	PTW047	MAIN PIVOT BOLT (M43x1.5, OD: 43, L:70, ID BSA)
34	1	NUT	1804038	PTW047	MP NUT M43X1.5, T:7, OD:54.5
59	2	SPACER	1804046	PTW047	MP BEARING SPACER ID:45 OD:57 T:8
2024 ALTITUDE MAIN PIVOT TOOL					
			1814023	PTW047	
61	1	TOOL	1804039	PTW047	BOTTOM BRACKET TOOL

LISTE DES KITS DE PETITES PIÈCES

		1814024	ZCA013
3	2 BEARING	1804045	PUS098
4	6 BEARING	1807042	PUS098
53	1 SLEEVE	1804035	PTW047
		1814025	ZCA013
3	2 BEARING	1804045	PUS098
		1814026	PTW047
6	1 BOLT	1804033	PTW047
9	1 BOLT	1804040	PTW047
		1814058	PTW047
6	1 BOLT	1804033	PTW047
13	1 BOLT	1805169	
		1814027	ZCA013
2	2 BEARING	1801010	PUS098
56	1 SLEEVE	1807028	PTW047
14	2 BRG CUP	1800031	PTW047
58	2 SPACER	1804042	PTW047
		1814028	PTW047
5	2 BEARING SPACER	1804049	PTW047
		1812007	
1	1 AXLE, REAR	3222000	PTW047
64	1 WASHER	3227006	PTW047
		1813467	PTW047
27	1 HT PORT COVER	1803012	PTW047
28	1 HT PORT COVER	1803013	PTW047
46	2 SCREW, M4X10	1800024-BK	PTW047
		1814039	ZCA013
12	3 BOLT	1804060	PTW047
35	2 PORT COVER	1093011	P0072
36	1 PORT COVER	1093012	P0072
37	1 PORT COVER	1093013	P0072
38	2 PORT COVER	1093014	P0072
		1814040	ZCA013
12	1 BOLT	1804060	PTW047
38	1 PORT COVER	1093014	P0072
		1814029	PTW047
20	1 FLIP CHIP	1804032	PTW047
21	1 FLIP CHIP	1804034	PTW047
		1814031	PTW047
22	1 FLIP CHIP	1804041	PTW047
23	1 FLIP CHIP	1804043	PTW047
		1814032	ZCA013
39	1 PROTECTOR	3704055	PTW110
40	1 PROTECTOR	3704056	PTW110
41	2 PROTECTOR	3704057	PTW110
42	1 PROTECTOR	3704058	PTW110
43	1 PROTECTOR	3704059	PTW110

2024 ALTITUDE PIVOT BEARING KIT

24ASPT ALTITUDE MP BEARING 6809 45X58X7
 ENDURO BEARING 6900 2RS MAX TYPE, 22X10X6 SIZE
 TOP LINK UPPER SLEEVE, OD:14, ID: 10.2, L:22

2024 ALTITUDE MAIN PIVOT BEARING ONLY KIT

24ASPT ALTITUDE MP BEARING 6809 45X58X7

2024 ALTITUDE SHOCK BOLT KIT

FORWARD SHOCK BOLT, M10x1.0, L:72
 LOWER LINK SHOCK BOLT, M8x1.0, L:51

2024 ALTITUDE SHOCK BOLT KIT SM

FORWARD SHOCK BOLT, M10x1.0, L:72
 LOWER 27.5 LINK SHOCK BOLT, M8x1.0, L:51, 11 MM THREAD

2024 ALTITUDE SHOCK BEARING EYELET KIT

ENDURO 688 LLU MAX 16X8X5
 BEARING EYELET CENTRE SLEEVE
 BEARING EYELET FOR 16X8X5 BRG
 LOWER LINK SHOCK SPACER, 8 MM THRU

2024 ALTITUDE FORWARD SHOCK REDUCER KIT

FORWARD SHOCK REDUCER 10 MM THRU

AXLE KIT BOOST 12X1.0

REAR AXLE 12X1.0 L:173MM, HARD BLACK ANODIZE
 WASHER, 12x19x0.5MM, 304 SS

NEW HEAD TUBE PANEL KIT (FROM 2023)

2023 SLAYER CARBON HT PORT COVER, RIGHT
 2023 SLAYER CARBON HT PORT COVER, LEFT
 C'SUNK SOCKET SCREW, M4x10MM, 10.9 STEEL, BLACK

ALLOY FRAME HT CABLE PORT KIT

M4x0.7 10MM HEX BUTTON HEAD
 ALLOY CABLE PORT COVER DOUBLE HOLE
 ALLOY CABLE PORT COVER BLANK
 ALLOY CABLE PORT COVER SINGLE 4mm HOLE
 ALLOY CABLE PORT COVER SINGLE 5mm HOLE

ALLOY FRAME CS CABLE PORT KIT

M4x0.7 10MM HEX BUTTON HEAD
 ALLOY CABLE PORT COVER SINGLE 5mm HOLE

RIDE 4 THREADED 10MM CHIP KIT

RIDE 4 CHIP - THREADED, M10x1.0, T:10
 RIDE 4 CHIP - 10 mm THRU

2024 ALTITUDE LOWER LINK FLIP CHIP

LOWER LINK FLIP CHIP 29 AND MX
 LOWER LINK CHIP THREAD, M8x1.0, 29 OR MX

2024 ALTITUDE ALLOY PROTECTION KIT

2024 ALTTIUDE CHAIN STAY UPPER PROTECTOR
 2024 ALTTIUDE SEAT STAY PROTECTOR
 2024 ALTTIUDE TAILGATE PROTECTOR
 2024 ALTTIUDE CHAIN STAY LOWER PROTECTOR
 2024 ALTTIUDE DOWN TUBE PROTECTOR

LISTE DES KITS DE PETITES PIÈCES

		1814062	ZCA013
39	1 PROTECTOR	3704055	PTW110
40	1 PROTECTOR	3704056	PTW110
41	2 PROTECTOR	3704057	PTW110
42	1 PROTECTOR	3704058	PTW110
44	1 PROTECTOR	3704108	PTW110
		1814033	ZCA013
32	1 MUD GUARD	1994026	P0072
49	4 SCREW	1804068	PTW047
33	1 MUD GUARD	1994027	P0072
48	2 SCREW	1804067	PTW047
		1814034	ZCA013
16	1 CHAINGUIDE	3391004	PTW021
17	1 CHAINGUIDE BASE	1394003	PTW047
18	1 CHAINGUIDE SLIDE	3391002	PTW047
47	1 SCREW	1804055	PTW047
		1814042	PTW047
19	1 COMPLETE COVER S-A	1994031	PTW047
		1814043	ZCA013
	2 M5 BARREL	1994049	P0072
	2 SCREW	1804074	PTW047
		1814044	ZCA013
60	1 SUBFRAME S-A	1814004	P0072
12	7 BOLT	1804060	PTW047
	1 WRAP	AC00340S1	P0064
	1 BAG	AC00330S1	P0064
		1814050	ZCA013
	1 HEAD SET CUP	1194002	PUS105
		1814051	ZCA013
	1 HEAD SET CUP	1194004	PUS105
		1814052	ZCA013
	1 HEADSET	1194001	PUS105
		1814053	ZCA013
	1 HEADSET	1194003	PUS105

2024 ALTITUDE CARBON PROTECTION KIT

2024 ALTTIUDE CHAIN STAY UPPER PROTECTOR
 2024 ALTTIUDE SEAT STAY PROTECTOR
 2024 ALTTIUDE TAILGATE PROTECTOR
 2024 ALTTIUDE CHAIN STAY LOWER PROTECTOR
 MY24 ALTITUDE CARBON DOWN TUBE PROTECTOR

2024 ALTITUDE MUD GUARD KIT

2024 ALTITUDE REAR TRIANGLE MUD GUARD
 M4x0.7 DOME HEAD SCREW, L:7, HEX 2.5
 2024 ALTTIUDE SHOCK MUD GUARD
 M4x0.7 DOME HEAD SCREW, L:12, HEX 2.5

2024 ALTITUDE CHAIN GUIDE

ONEUP CHAINGUIDE ASSEMBLY (1C0686)
 BASEPLATE FOR CHAINGUIDE
 SLIDING PART OF CHAINGUIDE
 C'SUNK SOCKET SCREW, M5X0.8, L:12 MM, 3MM HEX, SS

PENALTYBOX 2 COVER KIT

PENALTYBOX 2 COMPLETE COVER SUB-ASSEMBLY

PENALTYBOX 2 WB MOUNT INSERT KIT

BOTTLE CAGE M5 BARREL
 LOW PROFILE WATER BOTTLE SCREW M5x15

PENALTYBOX 2 FRAME MOUNT KIT

PENALTYBOX 2 MOUNTING FRAME
 M4x0.7 10MM HEX BUTTON HEAD

RMB TOOL WRAP 23 OS BK**RMB TUBE BAG 23 OS BK****5M OFFSET HEAD SET CUPS KIT CR BIKES**

FSA 5MM OFFSET OVAL CUPS W/ORING CR BIKES

5M OFFSET HEAD SET CUPS KIT AL BIKES

FSA 5MM OFFSET CUPS AL BIKES

OVAL OFFSET HEADSET KIT CR BIKES

FSA NO.85 1.5" 0MM OFFSET OVAL CUPS STAINLESS

OFFSET HEADSET KIT AL BIKES

FSA ZS56|66 0MM OFFSET HS STAINLESS STEEL

GARANTIE

Votre vélo est assorti d'une garantie contre les défauts de matériaux et de fabrication, dont voici les dispositions:

CATÉGORIE	DURÉE	NOTES
Cadre	5 ans	Triangles avant et arrière, maillons
Quincaillerie	1 an	Pivots, axes, etc.
Pièces de la transmission exposées à l'usure	1 an	Galets, pignons, chaîne
Batterie	2 ans	Si le vélo est entreposé pour trois mois ou plus, charger la batterie au moins tous les trois mois. Sinon, elle risque d'être endommagée.
Autres pièces	Selon la garantie du fabricant	

Toute garantie et service après-vente doivent être gérés par le détaillant Rocky Mountain autorisé qui a vendu le vélo ou le cadre complet. Nous couvrons votre cadre Rocky Mountain à compter de la date d'achat originale de votre nouveau vélo contre les défauts de matériaux et de fabrication, selon le matériau du cadre et le type d'utilisation faite du vélo.

La garantie limitée de Rocky Mountain couvre également les vélos précédemment utilisés à des fins personnelles et commerciales telles que la location (y compris dans les parcs à vélos), les services de messagerie, la police, la sécurité, etc., contre les défauts de matériaux et de fabrication. La garantie limitée s'applique pour le reste de la période de garantie à compter de la date d'achat initiale auprès de Rocky Mountain. Dans de tels cas, la quincaillerie, les roulements, les pivots et les bagues sont exclus de notre politique de garantie. Le reçu de vente original, la confirmation d'enregistrement du vélo ou toute autre preuve d'achat est requis pour toute réclamation.

Pour les vélos 2021 et plus récents, la garantie limitée d'origine est transférable aux propriétaires subséquents. Pour que la garantie limitée s'applique, l'enregistrement du vélo doit être effectué en ligne à la fois par le propriétaire original et par le propriétaire subséquent. La facture originale ne sera pas exigée pour le propriétaire subséquent.

Veillez enregistrer le vélo pour transférer la garantie.

Matériau du cadre/Type d'utilisation

- Carbon fiber: 5 years - Limited*
- Aluminum: 5 years - Limited*
- Please refer to limitations stated below

Autre couverture de garantie contre les défauts de fabrication et de matériaux

- Revêtement - peinture et autocollants : 1 an
 - Quincaillerie du cadre, pivots de suspension et bagues : 1 an
- *Les liens font partie du cadre le vélo pour transférer la garantie.

bikes.com/registration

GARANTIE

NOTES

La garantie n'est plus valide dans les cas suivants:

- Installation et utilisation de composants, pièces ou accessoires non initialement destinés ou compatibles avec le vélo (ou le cadre) tel que vendu.
- Acheter un vélo Rocky Mountain ou utiliser des sites Internet tiers (comme eBay), peu importe ce que dit l'annonce.
- La décoloration de la peinture causée par les effets de la lumière ultraviolette (UV) ou de l'exposition extérieure n'est pas couverte par cette garantie limitée.
- Rocky Mountain ne garantit aucun dommage causé à votre vélo lors de l'installation ou du retrait de tout film protecteur.
- Les rayures ou éclats de peinture causés par la saleté, les cailloux, les débris de la route, le transport en rack, etc. ne sont pas couverts par cette garantie limitée.
- Les dommages au boîtier de pédalier Pressfit causés par un service, des matériaux ou des pièces inappropriés ne sont pas couverts par la garantie limitée Rocky Mountain.

Détail de ce qui n'est pas couvert par la garantie :

1. L'usure normale des pneus, chambres à air, freins, câbles de transmission, plaquettes de frein, roulements, etc., n'est pas couverte par la présente garantie. Votre détaillant Rocky Mountain autorisé vous informera de la nature de ces éléments d'entretien normal.
2. Les dommages consécutifs ou tout dommage causé par un accident (chute), une mauvaise utilisation ou un abus.
3. Un assemblage incorrect ou un manque d'entretien approprié; le sablage, le ponçage, le meulage, le brossage métallique, le limage, le soudage, le brasage, le perçage de trous, l'anodisation, la peinture ou le chromage ne sont pas couverts par notre garantie et peuvent annuler la garantie des autres composants.
4. Vous prenez de grands risques personnels et rendez la garantie nulle, comme indiqué dans le tableau de garantie, lorsque vous roulez sur des terrains extrêmes tels que décrits dans des vidéos de vélo de montagne (c'est-à-dire rouler sur des parcours de style « trial », monter sur des rampes, faire des cascades, rouler sur pistes de BMX, rouler en ville en bas et sur les talus, ou rouler sur d'autres terrains similaires). Il est important de noter que les composants ayant pliés, les cadres, les fourches, les guidons, les tiges de selle, les pédales, les manivelles et les jantes sont des signes d'accidents ou d'abus.
5. La main d'œuvre pour le remplacement ou le changement de pièces n'est pas couvert sous la présente garantie.
6. Rocky Mountain se réserve le droit de réparer ou de remplacer, à sa discrétion, toute pièce considérée comme couverte sous garantie. Veuillez noter que Rocky Mountain fera tout son possible pour assurer, mais ne peut garantir, une correspondance de couleur avec le composant d'origine.

EXCLUSIONS ET LIMITE DES DOMMAGES

LA GARANTIE DE ROCKY MOUNTAIN EST LIMITÉE À LA RÉPARATION OU AU REMPLACEMENT DES PRODUITS ET N'ACCORDE AUCUNE GARANTIE EXPLICITE OU IMPLICITE, LÉGALE OU CONVENTIONNELLE ET DÉCLINE TOUTE GARANTIE IMPLICITE DE QUALITÉ MARCHANDE ET D'ADAPTATION À DES USAGES PARTICULIERS ET ROCKY MOUNTAIN NE SERA EN AUCUN CAS RESPONSABLE POUR LES DOMMAGES DIRECTS OU INDIRECTS, SPÉCIAUX, ACCESSOIRES OU CONSÉCUTIFS MÊME LORSQUE ROCKY MOUNTAIN A ÉTÉ AVISÉ DE TELS DOMMAGES, ET LA RESPONSABILITÉ DE ROCKY MOUNTAIN SERA LIMITÉE À 50,00\$.

EINLEITUNG

Entfesse unvergleichbares Selbstvertrauen mit dem Altitude. Egal, ob du deinen eigenen Zeitrekord brechen oder am Wochenende deinen Freundinnen und Freunde davonfahren willst – dieses Bike wurde speziell für Geschwindigkeit, abschüssige Trails und breitere Linien entwickelt. Seine Enduro-Fähigkeiten können dir nicht nur Podiumsplätze sichern, sondern auch bei anspruchsvolleren Wochenendabenteuern helfen. Mit so viel Leistungsfähigkeit möchte man alle Möglichkeiten ausreizen, schneller klettern und sich verbessern.

Diese Bedienungsanleitung enthält wichtige Sicherheits-, Wartungs- und Benutzerinformationen. Bitte lies sie sorgfältig durch und mache dich mit ihrem Inhalt vertraut, bevor du zum ersten Mal mit deinem neuen Rocky Mountain Bike fährst. Diese Informationen gelten nur für die von dir gewählte Plattform und sollten in Verbindung mit der Rocky Mountain-Bedienungsanleitung verwendet werden, die deinem Fahrrad beiliegt. Bitte lies die Bedienungsanleitung vor der ersten Fahrt. Falls du kein Exemplar der Bedienungsanleitung hast, kannst du sie bei deinem nächstgelegenen autorisierten Rocky Mountain Händler erhalten.

ETIKETTE DE LA MONTAGNE

Fahrer

Verhalte dich gegenüber anderen Trailbenutzern immer zuvorkommend. Besondere Vorsicht gilt in der Nähe von Tieren wie zum Beispiel Hunden und Pferden. Gewähre anderen Trailbenutzern in allen Situationen bergauf und bergab immer den Vortritt.

Trails

Fahre dein Rad nur auf Trails und Wegen, die für die Benutzung mit Fahrrädern freigegeben sind. Beachte alle lokalen Gesetze und Vorschriften. Wie auch alle anderen Trailbenutzer solltest du darauf achten, Beschädigungen des Trails oder der Umwelt zu vermeiden. Rutsche nicht auf Trails, und ändere sie nicht ab.



LERNE DEIN BIKE KENNEN



TECHNISCHE DETAILS

- Das brandneue Altitude hat ein komplett neues Design mit einer tiefer angesetzten Gewichtsverteilung, einer erhöhten Rahmensteifigkeit, zusätzlichen Einstellmöglichkeiten für eine optimierte Passform für alle Fahrer und Fahrerinnen sowie mehreren neuen technischen Merkmalen, die weit über die vorherigen Generationen hinausgehen.
- Die überarbeitete LC2R-Kinematik verbindet ein sensibles Ansprechverhalten mit mehr Unterstützung auf der gesamten Federkennlinie und vermindert die Fahrerermüdung auf langen und harten Endurostrecken.
- Der Rahmen in Größe SM ist mit 27,5"-Vorder- und Hinterrädern ausgestattet. Bei den Rahmen in Größe MD, LG und XL werden 29"-Vorder- und Hinterräder verwendet. Die MD-LG-XL-Rahmen können auf Wunsch mit einem MX-Laufradsetup (29" vorne / 27,5" hinten) ausgerüstet werden, ohne dass zusätzliche Rahmenteile erforderlich sind.
- Das RIDE-4™-Einstellungssystem ermöglicht dem Fahrer eine schnelle Feinabstimmung der Geometrie mit einem Inbusschlüssel.
- Alle Rahmen sind mit Steuersätzen für eine Reach-Feineinstellung ausgerüstet. Ein 0-mm/neutraler Steuersatz ist am Rahmen vormontiert. In der Kleinteilebox, die jedem Rahmenset und Komplettrad beiliegt, befindet sich ein zusätzlicher Satz 5-mm-Lagerschalen, mit denen der Reach angepasst werden kann.
- Unser neues Staufach Penalty Box 2.0 ist wasserdicht und zeichnet sich durch eine steife Konstruktion mit zwei benutzerfreundlichen Schnappverschlüssen aus. Darin findest du auch ein Geheimfach, in dem du ein Ortungsgerät wie Tile oder AirTag anbringen kannst, um dein Fahrrad besser zu schützen.
- Sämtliches Rahmenezubehör kann v unter dem Oberrohr angebracht werden für zusätzlichen Stauraum. Bei Rahmen der Größe LG und XL kann an dieser Stelle eine zweite 600-ml-Wasserflasche angebracht werden.
- Abgedichtete Lager an der Dämpferaufnahme verbessern die Empfindlichkeit des Dämpfers dramatisch (und sind mit Sekundärmarkt-Dämpfern kompatibel), während Lagerschilde am gesamten Rahmen verhindern, dass das Fahrrad auf rauen Trails oder in einer Waschstation Schmutz ansammelt.

LERNE DEIN BIKE KENNEN



TECHNISCHE DETAILS

- Unser LC2R-Federungssystem verfügt über einen konzentrischen Hauptdrehpunkt am Tretlager mit einem steifen Link-Design. Dazu gehören langlebige, übergroße Lager.
- Alle Modelle umfassen eine integrierte Kettenführung von OneUp Components, die nach der ISCG 05 Montageart mit zwei Schrauben befestigt wird und das Anbringen eines Bashguards ermöglicht, um Kettenabwurf und Kettenschlagen zu vermeiden.
- Die Rahmen sind mit einem umfangreichen Gummischutz versehen, der sowohl Geräusche als auch Kontaktabrieb verhindert.
- Alle Rahmengrößen sind mindestens mit Wasserflaschen der Größe LG (600 ml) kompatibel.

GEOMETRIE UND GRÖSSEN

Das Altitude hat ein größenspezifisches Rahmendesign mit vielen Details, die die Passform und Geometrie für jeden Fahrer und jede Fahrerin verbessern.

Lauftradgröße

- Der SM-Rahmen ist vorne und hinten mit 27,5"-Lafrädern ausgestattet.
- Die Rahmengrößen MD, LG und XL sind mit 29"-Vorder- und Hinterrädern ausgerüstet und sind auch mit einem MX/Mullet-Laufradsetup kompatibel.
- Für die MX-Einstellung wird die Position des Stoßdämpferbrücken-Chips am unteren Link verändert.

Chip in 29"-Position



Chip in MX-Position (27,5")



Hinterbaulänge (manchmal auch als Kettenstrebenlänge bezeichnet)

- Die hinteren Rahmendreiecke sind größenspezifisch, wobei LG und XL die gleiche Version haben. Weitere Einzelheiten findest du in der Geometrietabelle. Bei Rahmengröße MD, LG und XL können die hinteren Rahmendreiecke ausgetauscht werden, wenn man mit verschiedenen Hinterbaulängen experimentieren möchte.

Steuersatz mit Reach-Einstellung

- Alle Rahmen sind mit Steuersätzen für eine Reach-Feineinstellung ausgerüstet. Ein 0-mm/neutraler Steuersatz ist am Rahmen vormontiert. In der Kleinteilebox, die jedem Rahmenset und Komplettrad beiliegt, befindet sich ein zusätzlicher Satz 5-mm-Lagerschalen, mit denen der Reach angepasst werden kann. Wenn du die Geometrietabelle mit den um 5 mm versetzten Lagerschalen betrachtest, musst du einfach 5 mm von den Maßen für Reach, Oberrohrlänge und Radstand addieren oder subtrahieren, um die Ausrichtung der Lagerschalen anzupassen. Montageanweisungen findest du im Abschnitt zu den Rahmeneigenschaften.

Carbon-Steuersatz 0 mm



Carbon Steuersatz 5 mm



Alloy Steuersatz 0 mm



Alloy Steuersatz 5 mm



GEOMETRIE UND GRÖSSEN

Ride-4

Das RIDE-4™-Einstellungssystem ermöglicht dem Fahrer/der FahrerIn eine schnelle Feinabstimmung der Geometrie mit einem 6-mm Inbusschlüssel. Vier Konfigurationen sind mit einem Paar rotierender Chips möglich. Wie sich die einzelnen Positionen auf die Geometrie auswirken, wird in der Geometrietabelle dargelegt. Anweisungen zur Einstellung findest du im Abschnitt zu den Rahmeneigenschaften.

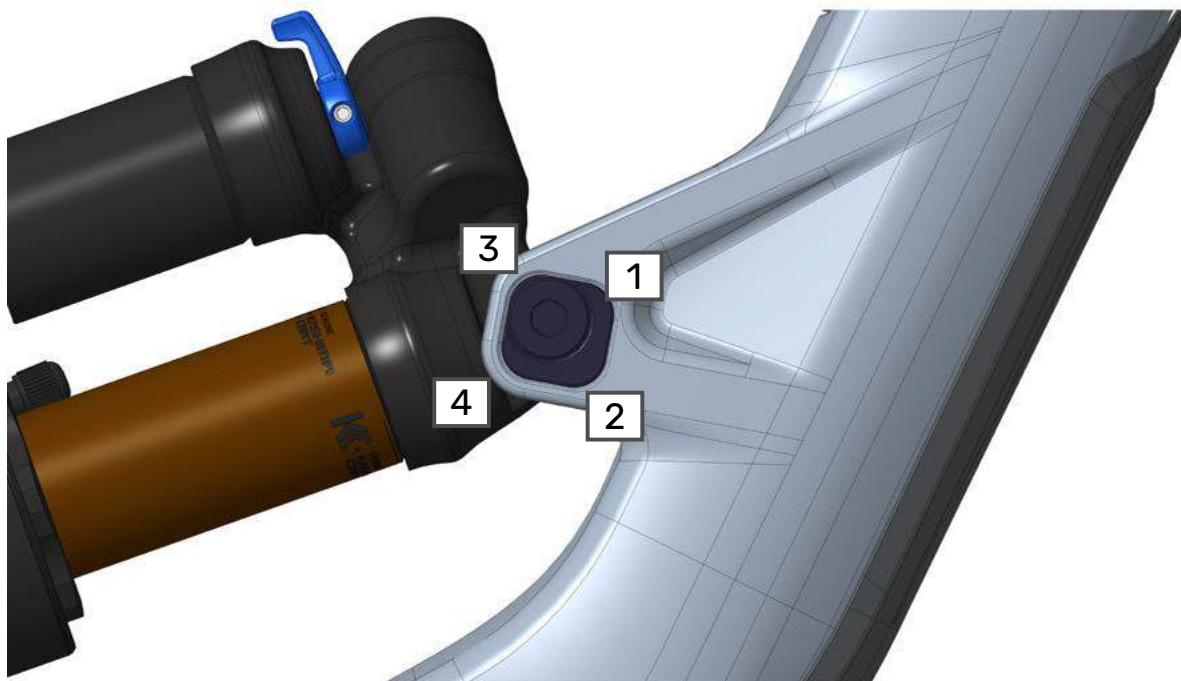

GEOMETRIE UND GRÖSSEN

Rahmengrößen

Diese Tabelle dient nur als grober Anhaltspunkt. Faktoren, die die Auswahl der richtigen Fahrradgröße beeinflussen, sind die Proportionen des Fahrers, der Fahrstil und persönliche Vorlieben. Im Allgemeinen haben Fahrräder mit kürzerem Reach ein dynamischeres, lebendigeres Fahrgefühl. Das Fahrgefühl auf längeren Fahrrädern ist in der Regel stabiler und gedämpfter. Rocky Mountain empfiehlt daher, die Bikes immer bei einem Vertragshändler Probe zu fahren und professionell anpassen zu lassen.

CM	152.5	155	157.5	160	162.5	165	167.5	170	172.5	175	177.5	180	183	185.5	188	190.5	193	195.5	198
FT-IN	5'0"	5'1"	5'2"	5'3"	5'4"	5'5"	5'6"	5'7"	5'8"	5'9"	5'10"	5'11"	6'	6'1"	6'2"	6'3"	6'4"	6'5"	6'6"
	SM				MD				LG				XL						
SM																			
MD																			
LG																			
XL																			
CM	152.5	155	157.5	160	162.5	165	167.5	170	172.5	175	177.5	180	183	185.5	188	190.5	193	195.5	198
FT-IN	5'0"	5'1"	5'2"	5'3"	5'4"	5'5"	5'6"	5'7"	5'8"	5'9"	5'10"	5'11"	6'	6'1"	6'2"	6'3"	6'4"	6'5"	6'6"
	SM				MD				LG				XL						
SM																			
MD																			
LG																			

Geometrietabelle

RAHMENGRÖSSE Laufradgröße	SM 27.5	MD	LG 29	XL	MD	LG MX	XL
Steuerrohrwinkel (Grad)	63	63	63	63	62,9	62,9	62,9
Sitzrohrwinkel (Grad)	77	77	77	77	77	77	77
Sitzrohrlänge (mm)	365	410	440	470	410	440	470
Oberrohrlänge (mm)	553	584	610	642	584	610	642
Steuerrohrlänge (mm)	100	105	115	130	105	115	130
Hinterbaulänge (mm)	Position 1 Slack		430	440	450	450	450
Tretlagerabsenkung (mm)	24	38	38	38	29	29	29
Schritthöhe (mm)	760	792	798	809	791	797	808
Radstand (mm)	1189	1244	1283	1319	1243	1282	1319
Reach (mm)	424	450	475	505	450	475	505
Stack (mm)	599	630	639	653	630	639	653

GEOMETRIE UND GRÖSSEN

RAHMENGRÖSSE Laufradgröße	SM 27.5	MD	LG 29	XL	MD	LG MX	XL
Steuerrohrwinkel (Grad)	63,3	63,3	63,3	63,3	63,2	63,2	63,2
Sitzrohrwinkel (Grad)	77,3	77,3	77,3	77,3	77,2	77,2	77,2
Sitzrohrlänge (mm)	365	410	440	470	410	440	470
Oberrohrlänge (mm)	553	584	610	642	584	610	642
Steuerrohrlänge (mm)	100	105	115	130	105	115	130
Hinterbaulänge (mm)	430	440	450	450	440	450	450
Tretlagerabsenkung (mm)	20	34	34	34	25	25	25
Schritthöhe (mm)	763	794	801	812	793	801	812
Radstand (mm)	1189	1243	1283	1319	1242	1282	1318
Reach (mm)	427	453	478	508	453	478	508
Stack (mm)	599	630	639	653	630	639	653
Steuerrohrwinkel (Grad)	63,5	63,5	63,5	63,5	63,4	63,4	63,4
Sitzrohrwinkel (Grad)	77,5	77,5	77,5	77,5	77,4	77,4	77,4
Sitzrohrlänge (mm)	365	410	440	470	410	440	470
Oberrohrlänge (mm)	553	584	610	642	584	610	642
Steuerrohrlänge (mm)	100	105	115	130	105	115	130
Hinterbaulänge (mm)	430	440	450	450	440	450	450
Tretlagerabsenkung (mm)	17	31	31	31	22	22	22
Schritthöhe (mm)	765	796	803	814	796	803	814
Radstand (mm)	1188	1243	1282	1319	1242	1281	1318
Reach (mm)	430	455	480	510	455	480	510
Stack (mm)	599	630	639	653	630	639	653
Steuerrohrwinkel (Grad)	63,8	63,8	63,8	63,8	63,7	63,7	63,7
Sitzrohrwinkel (Grad)	77,8	77,8	77,8	77,8	77,7	77,7	77,7
Sitzrohrlänge (mm)	365	410	440	470	410	440	470
Oberrohrlänge (mm)	553	584	610	642	584	610	642
Steuerrohrlänge (mm)	100	105	115	130	105	115	130
Hinterbaulänge (mm)	430	440	450	450	440	450	450
Tretlagerabsenkung (mm)	13	27	27	27	18	18	18
Schritthöhe (mm)	768	798	806	817	798	806	817
Radstand (mm)	1188	1242	1282	1319	1241	1281	1317
Reach (mm)	433	458	483	513	458	483	513
Stack (mm)	599	630	640	653	630	639	653

GEOMETRIE UND GRÖSSEN

Passung von Vario-Sattelstützen

Vario-Sattelstützen spielen eine wichtige Rolle, wenn es um die Passform und den Komfort von Fahrrädern geht. Nachfolgend findest du die wichtigsten Abmessungen, die dir bei der Konfiguration der OEM-Sattelstütze helfen, sowie einige der möglichen Optionen für Sekundärmarkt-Sattelstützen. Die Tabelle zeigt die Passung der Sattelstütze in voll ausgefahrenem Zustand. Damit kannst du die niedrigste bzw. höchste Position deiner Sattelstütze für die korrekte Höhe in einer sitzenden Tretposition ermitteln. Die Tabelle hilft auch, die richtige Größe der Sattelstütze zu bestimmen, wenn die OEM-Stütze nicht wie gewünscht passt. Bitte beachte, dass die angegebenen Maße von der Mitte des Tretlagers bis zur Oberseite des OEM-Sattels ermittelt wurden. Die Länge der Kurbelgarnitur kann die Sitzposition beeinflussen und sollte ebenfalls berücksichtigt werden, wenn diese Komponente geändert wird.

So verwendest du diese Tabelle

1. Miss deine aktuelle Sattelhöhe von der Mitte des Tretlagers bis zur Oberkante des Sattels direkt über der Sattelstütze.
2. Wähle das gewünschte Sattelstützenmodell und den gewünschten Hub sowie den Rahmen.
3. Vergewissere dich, dass deine Messung im Bereich zwischen der in der Tabelle angegebenen Mindest- und Höchsteinschubtiefe liegt.

Beispiel: Bei meinem derzeitigen Fahrrad habe ich 795 mm gemessen. Wenn ich mich für ein OneUp V3 mit 210 mm Hub an einem LG Carbon-Rahmen entscheide, kann ich sehen, dass diese Kombination aus Federweg und Rahmengröße passt, da die möglichen Mindest- und Höchstmaße 735 mm bis 860 mm betragen.

Sattelstützen-Modell	Hub	Rahmengröße	Carbon				Alloy			
			SM	MD	LG	XL	SM	MD	LG	XL
X Fusion Manic		Sitzrohrlänge	365	410	440	470	365	410	440	470
		Mindesteinschubtiefe	100	100	100	100	100	100	100	100
		Höchsteinschubtiefe	212	260	290	320	192	240	270	300
	150	Minimale Sattelhöhe	661	658	685	715	681	678	685	715
	150	Maximale Sattelhöhe	735	780	810	840	735	780	810	840
	170	Minimale Sattelhöhe	705	702	705	735	725	722	722	735
	170	Maximale Sattelhöhe	749	794	824	854	749	794	824	854
	200	Minimale Sattelhöhe	770	767	767	767	790	787	787	787
	200	Maximale Sattelhöhe	794	839	869	899	794	839	869	899
	200	Minimale Sattelhöhe	732	737	737	766	772	747	777	807
	200	Minimale Sattelhöhe	794	839	869	899	794	839	869	899
2020- 2024	150	Minimale Sattelhöhe	644	643	673	703	664	661	673	703
	150	Maximale Sattelhöhe	728	773	803	833	728	773	803	833
	175	Minimale Sattelhöhe	701	698	698	728	721	718	718	728
	175	Maximale Sattelhöhe	785	830	860	890	785	830	860	890
Race Face Turbine R	200	Minimale Sattelhöhe	757	754	754	754	777	774	774	774
Fox Transfer	200	Maximale Sattelhöhe	791	836	866	896	791	836	866	896
	200	Minimale Sattelhöhe	719	724	724	754	759	734	764	794
	200	Minimale Sattelhöhe	791	836	866	896	791	836	866	896
	200	Minimale Sattelhöhe	791	836	866	896	791	836	866	896

GEOMETRIE UND GRÖSSEN

SATTELSTÜTZEN-MODELL	HUB	RAHMENGRÖSSE	CARBON				ALLOY			
			SM	MD	LG	XL	SM	MD	LG	XL
Reverb AXS *min. Einschublänge ist 80 mm, der Rahmen erfordert jedoch 100 mm	150	Minimale Sattelhöhe	661	670	700	730	681	678	700	730
	150	Maximale Sattelhöhe	750	795	825	855	750	795	825	855
	170	Minimale Sattelhöhe	701	698	720	750	721	718	720	750
	170	Maximale Sattelhöhe	790	835	865	895	790	835	865	895
OneUp V2 Dropper *Der Hub ist einstellbar und kann in 10-mm-Schritten bis zu 20 mm reduziert werden.	150	Minimale Sattelhöhe	618	638	668	698	638	638	668	698
	150	Maximale Sattelhöhe	725	770	800	830	725	770	800	830
	180	Minimale Sattelhöhe	678	675	698	728	698	695	698	728
	180	Maximale Sattelhöhe	755	800	830	860	755	800	830	860
	210	Minimale Sattelhöhe	738	735	735	758	758	755	755	758
	210	Maximale Sattelhöhe	785	830	860	890	785	830	860	890
	240	Minimale Sattelhöhe	808	805	805	805	828	825	825	825
	240	Maximale Sattelhöhe	815	860	890	920	815	860	890	920
BikeYoke Divine 3 * Der Hub ist einstellbar und kann in 5mm-Schritten bis zu 30 mm reduziert werden, je nach Hub-Option.	160	Minimale Sattelhöhe	649	652	682	712	669	666	682	712
	160	Maximale Sattelhöhe	740	785	815	845	740	785	815	845
	185	Minimale Sattelhöhe	699	696	707	737	719	716	716	737
	185	Maximale Sattelhöhe	790	835	865	895	790	835	865	895
	213	Minimale Sattelhöhe	764	761	761	765	784	781	781	781
	213	Maximale Sattelhöhe	825	870	900	930	825	870	900	930

SPEZIFIKATIONEN UND ABMESSUNGEN

Rahmenmerkmale

Konzentrischer Hauptdrehpunkt am Tretlager

Das neue Altitude ist mit einem konzentrischen Hauptdrehpunkt am Tretlager ausgestattet, für dessen Montage und Demontage ein spezielles Werkzeug erforderlich ist. Dieses Werkzeug (Artikelnummer 59, Teilenummer 1804039) wird mit jedem Rahmensatz und jedem Komplettrad in der Kleinteilebox mitgeliefert, um sicherzustellen, dass Besitzer bzw. Besitzerinnen die Wartung selbst durchführen können oder, wenn sie den Rahmen extern warten lassen, das Werkzeug entsprechend zur Verfügung stellen können. Das Werkzeug ist mit dem korrekten Installationsdrehmoment (25 Nm) gekennzeichnet, um eine korrekte Montage zu gewährleisten.

Explosionszeichnung Altitude unterer Link

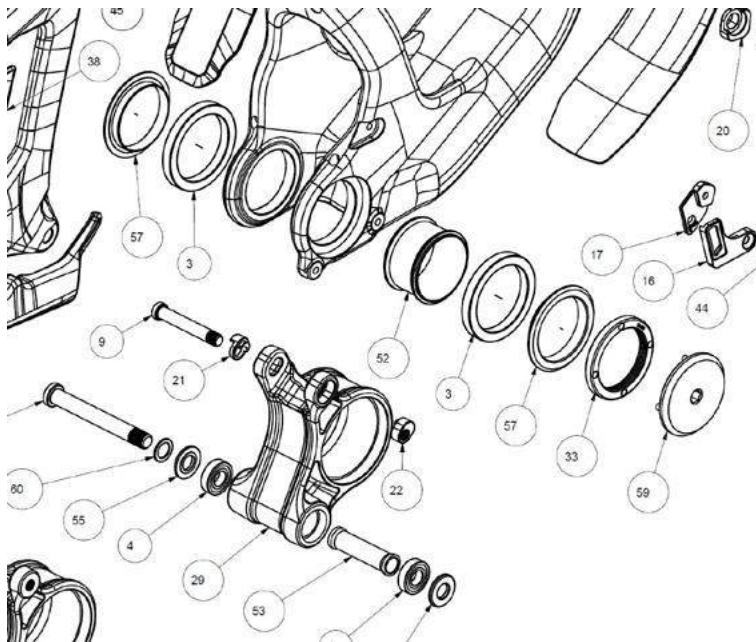

Der Hauptdrehpunkt ist im Rahmen verkeilt, um zu verhindern, dass er sich während des Montageprozesses dreht. Ein geringfügiges Rotationsspiel zwischen der verkeilt Schnittstelle der Hauptdreihachse und dem Rahmen ist zulässig. Der Drehpunkt ist sicher befestigt, wenn die Kontermutter korrekt angezogen ist.

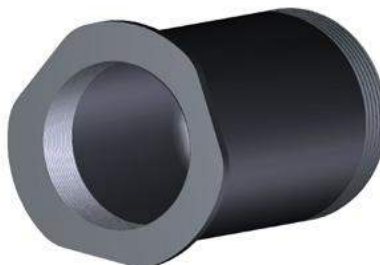

SPEZIFIKATIONEN UND ABMESSUNGEN

Steuersatz mit Reach-Einstellung

Alle Rahmen sind mit Steuersätzen für eine Reach-Feineinstellung ausgerüstet. Ein 0-mm/neutraler Steuersatz ist am Rahmen vormontiert. In der Kleinteilebox, die jedem Rahmenset und Kompletttrrad beiliegt, befindet sich ein zusätzlicher Satz 5-mm-Lagerschalen, mit denen der Reach angepasst werden kann.

Der Carbon Instinct-Rahmen verwendet ovale Steuersatz-Lagerschalen im Drop-in-Stil. Für den Aus- und Einbau der Lagerschalen in den Rahmen sind keine Werkzeuge erforderlich. Die Ausrichtung der Lagerschalen erfolgt automatisch durch die codierte ovale Form von Schalen und Steuerrohr. Damit die Lagerschalen sicher im Rahmen sitzen und die bewegungsbedingte Geräuschbildung so gering wie möglich bleibt, sind die Lagerschalen an der Außenseite mit einem integrierten O-Ring versehen. Die Steuersätze für die Carbon-Rahmen werden von FSA hergestellt und haben Modell-Nr. 85-1. Weil hier Standard-FSA-Montageteile wie Lager und Laufringe zum Einsatz kommen, ist der Austausch von Verschleißteilen ein leichtes Spiel.

Der Alloy Instinct-Rahmen verwendet übergroße Steuersatz-Lagerschalen im Press-in-Stil. Für den Aus- und Einbau der Lagerschalen in den Rahmen wird spezielles Werkzeug benötigt. Weil Lagerschalen und Steuerrohr nicht codiert sind, ist bei der korrekten Ausrichtung Vorsicht geboten. Die Lagerschalen sind an der Außenseite mit einer Markierung versehen, mithilfe derer sie am Rahmen ausgerichtet werden. Am einfachsten stellt man die korrekte Ausrichtung der Lagerschale sicher, indem man ein langes Lineal entlang dieser Markierung über die Länge des Oberrohrs (obere Lagerschale) bzw. Unterrohrs (untere Lagerschale) anlegt. Die Steuersätze für die Alloy-Rahmen werden von FSA hergestellt und haben Modell-Nr. HS-RM-01. Weil hier Standard-FSA-Montageteile wie Lager und Laufringe zum Einsatz kommen, ist der Austausch von Verschleißteilen ein leichtes Spiel.



SPEZIFIKATIONEN UND ABMESSUNGEN

Montage Altitude Carbon-Steuersatz

ARTIKELNUMMER	ANZ.	ARTIKEL	TEILENUMMER	BESCHREIBUNG
N/A	N/A	Steuersatz	H0504H0000EK01	FSA Nr.85-10 mm Offset-Steuersatz, komplett
N/A	N/A	Lagerschalensatz	H4204G00ZZE900	FSA Nr.85-15 mm Offset (nur Lagerschalen)
1	1	Gummi-O-Ring	MS053 (872)	Innerer Gummi-O-Ring Spanndeckel
2	1	Spanndeckel	H2051A	FSA 5,3 mm Spanndeckel
3	1	Gummidichtung	MS073	Äußere Gummidichtung Spanndeckel
4	1	Konusmutter	H2036 (No.5-2)	FSA 11/8" Steuersatz Kompressionsring
5	1	Lager	MR054S	FSA Edelstahl ACB 11/8" 36°x45° Lager
6	1	Obere Lagerschale	H4205A	FSA Obere Lagerschale 0 mm Offset
	1	Obere Lagerschale	H4204	FSA Obere Lagerschale 5 mm Offset
7	1	Gummi-O-Ring	MS399	O-Ring obere Lagerschale
8	1	Gummi-O-Ring	MS406	O-Ring untere Lagerschale
9	1	Untere Lagerschale	H5145A	FSA Untere Offset-Lagerschale 0 mm
	1	Untere Lagerschale	H5144	FSA Untere Offset-Lagerschale 5 mm
10	1	Lager	MR110S	FSA Edelstahl ACB 1,5" 36°x45° Lager
11	1	Gabelkonus	H6083 (No.42)ACB-6)	FSA 1,5" Gabelkonus

Montage Altitude Alloy-Steuersatz

ARTIKELNUMMER	ANZ.	ARTIKEL	TEILENUMMER	BESCHREIBUNG
N/A	N/A	Steuersatz	H066500000E101	FSA RMB ZS56 66 0 mm Offset-Steuersatz, komplett
N/A	N/A	Lagerschalensatz	H4214A00ZZE100	FSA RMB ZS56 66 5-mm Offset (nur Lagerschalen)
1	1	Gummi-O-Ring	MS053 (872)	Innerer Gummi-O-Ring Spanndeckel
2	1	Spanndeckel	H2051A	FSA 5,3 mm Spanndeckel
3	1	Gummidichtung	MS073	Äußere Gummidichtung Spanndeckel
4	1	Konusmutter	H2036 (No.5-2)	FSA 11/8" Steuersatz Kompressionsring
5	1	Lager	MR054S	FSA Edelstahl ACB 11/8" 36°x45° Lager
6	1	Obere Lagerschale	H4217	FSA Obere Lagerschale ZS56 0 mm Offset
	1	Obere Lagerschale	H4214	FSA Obere Lagerschale ZS56 5 mm Offset
7	1	Untere Lagerschale	H5149	FSA Untere Lagerschale ZS66 0 mm Offset
	1	Untere Lagerschale	H5148	FSA Untere Lagerschale ZS66 5 mm Offset
8	1	Lager	MR110S	FSA Edelstahl ACB 1,5" 36°x45° Lager
9	1	Gabelkonus	H6083 (No.42)ACB-6)	FSA 1,5" Gabelkonus

GEOMETRIE UND GRÖSSEN

Ride-4

Das RIDE-4™-Einstellungssystem ermöglicht dem Fahrer/der Fahrerin eine schnelle Feinabstimmung der Geometrie mit einem 5-mm Inbusschlüssel. Vier Konfigurationen sind mit einem Paar rotierender Chips möglich. Wie sich die einzelnen Positionen auf die Geometrie auswirken, wird in der Geometrietabelle dargelegt. Anweisungen zur Einstellung findest du im Abschnitt zu den Rahmeneigenschaften.

BEREIT FÜR JEDEN TRAIL

Das RIDE-4™-Einstellsystem ermöglicht dir eine schnelle Feinabstimmung deiner Geometrie und Aufhängung mit einem einzigen 5 mm-Inbusschlüssel.

FLACHERER LENKWINKEL
PROGRESSIVE FEDERUNG

STEILERER LENKWINKEL
WENIGER PROGRESSIVE FEDERUNG

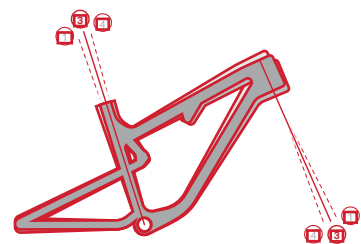
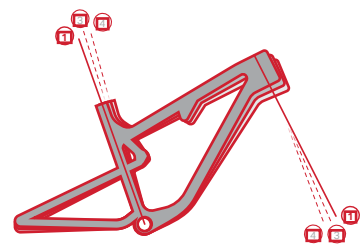

Position 1



Das tiefere Tretlager und die progressive Federung erhöhen die Stabilität bei hoher Geschwindigkeit. Empfohlen für aggressivere Trails.

Position 3



Diese Position bietet eine ausgewogene Mischung von Geometrie und Federungsleistung und ist damit für viele verschiedene Trails geeignet.

Position 4



Das höhere Tretlager und die lineare Federung bieten eine bessere Pedalfreiheit, mehr Unterstützung bei der anfänglichen Federkonstante und eine Position auf dem Rad, die besser zum Klettern geeignet ist.

PENALTY BOX 2.0

La version carbone du cadre Altitude 2024 est équipée du tout nouveau rangement Penalty Box 2.0, muni d'une pochette à outils et à chambre à air. Le couvercle est maintenu en place par notre système innovant de fermoir double anti vibration. Pour ouvrir le rangement, il suffit de tirer la languette extérieure. Il n'est pas nécessaire d'enlever la gourde d'eau, mais cela peut faciliter l'accès au besoin. Wenn du eine Wasserflasche installiert hast, musst du diese nicht unbedingt abnehmen, aber das kann den Zugang erleichtern. Beachten Sie, dass die meisten Flaschenhalter zwar mit der Penalty Box 2.0-Abdeckung kompatibel sind, einige jedoch ohne Anpassung nicht kompatibel sind. Wir empfehlen, den Sitz des Käfigs zu testen und sicherzustellen, dass der Riegel den vollen Bewegungsspielraum zum Lösen des Deckels hat. In einigen Fällen schaffen unter dem Käfig angebrachte Unterlegscheiben zusammen mit den erforderlichen längeren Schrauben ausreichend Platz für die Betätigung des Riegels.



Die Abdeckung verfügt über ein spezielles Geheimfach, in dem du ein Ortungsgerät wie Tile oder AirTag unterbringen kannst. Um an dieses Geheimfach zu gelangen, nimmst du die Schrauben der Wasserflasche und die Muttern auf der Innenseite der Abdeckung ab. Dann musst du die M 2,5 Sechskantschraube entfernen, die am gleichen Abdeckungsrahmenteil angebracht ist, das auch das Geheimfach sichert. Dann kannst du auf das Fach zugreifen. Folge den Anweisungen für den Ausbau in umgekehrter Reihenfolge, um die Abdeckung wieder zu montieren.



TIPPS FÜR DAS TOOL WRAP (NUR CARBON)

Damit der Schlauch einfach entnommen oder verstaut werden kann, muss er vollständig entleert und eng in das mitgelieferte Tool Wrap eingewickelt sein. Achte darauf, dass das Halteband immer zur Öffnung hin zeigt, damit du das Tool Wrap leicht greifen kannst, falls es nach unten zum Tretlager oder nach oben zum Oberrohr abwandert.

Packe nicht zu viele Gegenstände in das Tool Wrap, damit es sich leicht verstauen und herausnehmen lässt. Das Tool Wrap ist so konzipiert, dass es ein kleines Multitool, eine kleine Pumpe oder eine CO₂-Kartusche und verschiedene andere kleine Gegenstände wie Schlüssel, Geld und Flickzeug aufnehmen kann.

SPEZIFIKATIONEN UND ABMESSUNGEN

MX/Mullet-Einstellung

Der Rahmen in Größe SM ist mit 27,5"-Vorder- und Hinterrädern ausgestattet. Bei den Rahmen in Größe MD, LG und XL werden 29"-Vorder- und Hinterräder verwendet. Die MD-LG-XL-Rahmen können auf Wunsch mit einem MX-Laufradsetup (29" vorne / 27,5" hinten) ausgerüstet werden, ohne dass zusätzliche Rahmenteile erforderlich sind. Für die MX-Einstellung wird die Position des Stoßdämpferbrücken-Chips am unteren Link verändert. Nimm mit einem 5-mm-Inbusschlüssel die hintere Dämpferschraube auf der Nichtantriebsseite ab und positioniere die Chips auf jeder Seite in der richtigen Position für die MX-Einstellung. Wenn du zu einer 29"-Einstellung zurückkehrst, installiere die Chips in der 29"-Position. Die richtigen Positionen kannst du dem nachstehenden Diagramm entnehmen.

Chip in MX-Position (27,5")



Chip in 29"-Position



UDH SCHALTAUGE

Dein neuer Rahmen ist mit dem UDH Schaltauge von Sram kompatibel. Für die Montage sind keine zusätzlichen Teile erforderlich, und die OEM-Achse ist mit dem SRAM UDH-Schaltauge kompatibel.

1.

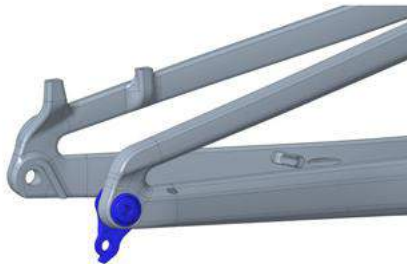

2.



LAGERBUCHSEN UND HARDWARE FÜR DÄMPFER

Dein Rahmen ist in der hinteren Buchse mit Industrielagern ausgestattet, um das Ansprechverhalten zu verbessern. Diese Lager sitzen in Schalen mit sehr fester Presspassung in dem Dämpferschaft. Wenn du deinen Dämpfer warten lässt, empfehlen wir unbedingt den Ausbau dieser Komponenten, da Federungs-Servicecenter deren Rücksendung nicht garantieren können. Die vordere Stoßdämpferhardware ist eine Kombination aus Rocky Mountain Reduzierstücken (Teilenummer 5) und der vom Stoßdämpferhersteller gelieferten Hardware. In der nachstehenden Tabelle findest du technische Informationen zu allen Dämpferhardwareteilen, Referenzzeichnungen und Anweisungen zum Entfernen der Lagerbuchsen.

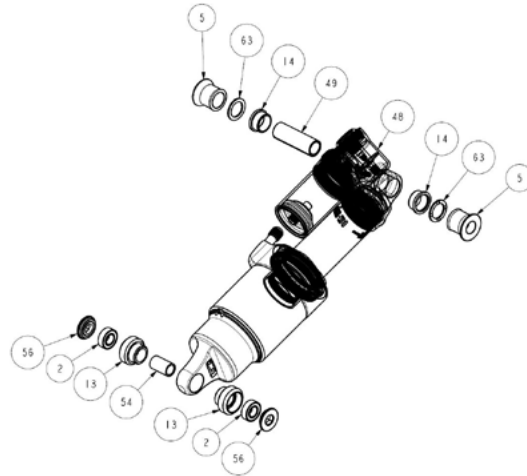

Altitude Dämpfer-Lagerbuchsen Hinterbau – 35 x 8 mm (Breite x Durchmesser der Hardware)

ARTIKELNUMMER	ANZ.	ARTIKEL	TEILENUMMER	BESCHREIBUNG
N/A	1	Trousse complète Rocky Mountain	TBD	8 x 35 mm Dämpfer-Lagerbuchsenset
2	2	Roulement	1801010	ENDURO 688 LLU MAX 16X8X5
13	2	Cuvette de roulement	1800031	DÄMPFER-LAGERBUCHSEN 16X8X5 LAGER
54	1	Douille	1807028	INNENLAGERHÜLSE DÄMPFERBUCHSE
56	2	Entretoise	1804042	ABSTANDSHALTER UNTERER LINK, 8 MM DURCHGEHEND

Altitude Dämpferhardware Vorderbau – 40 x 10 mm (Dämpferstiftbreite x Hardware-Durchmesser)

ARTIKELNUMMER	ANZ.	ARTIKEL	TEILENUMMER	BESCHREIBUNG
5	2	Abstandshalter	1804049	REDUZIERSTÜCK DÄMPFER VORNE, 10 MM DURCHGEHEND
14	2	Fox-Buchse	213-01-263	FOX IGUS BUCHSE
	2	Rock Shox Buchse	11.4115.013.000	ROCK SHOX TEFLONBUCHSE
49	1	Dämpferstift	N/A	DÄMPFERSTIFT (siehe Informationen zum Komplettsset unten)
63	2	Unterlegscheibe Dämpfer	N/A	CRUSH WASHER (siehe Informationen zum Komplettsset unten)
N/A	1	Fox Komplettsset	803-03-329	FOX Befestigungshardware – 9-teilig, SS 10 mm x 40/1,575 *Nicht die im Set enthaltenen großen Kunststoffabstandshalter verwenden!
N/A	1	Rock Shox Komplettsset	N/A	ZSB 3-TEILIG 1/2" HDW WD 3,65 ABSTANDSHALTER 40,0 x 10
N/A	1	Rock Shox Komplettsset	11.4118.091.005	ROCK SHOX HARDWARE 10 x 0,0 *Stift nicht verwenden
N/A	1	Rock Shox Komplettsset	11.4118.091.012	ROCK SHOX HARDWARE 10 x 40,0 *Abstandshalter nicht verwenden

Profi-Tipp: Das Fox Komplettsset ist kompatibel mit der Rock Shox Dämpferaufnahme. Ziehe die Teflonbuchse aus der Rock Shox-Aufnahme, bevor du das Fox-Set einbaust.

LAGERBUCHSEN UND HARDWARE FÜR DÄMPFER

Ausbau der Lagerbuchsen

Befolge zum Ausbau des Systems diese Schritte:

- Verwende den Rocky Mountain Lagerbuchsen-Werkzeugsatz (Teile-Nr. 1810031)
- Bringe das obere Kopfteil an einer Seite der Lagerbuchse an.
- Bringe als nächstes einen der Lagerschalenabzieher über der Lagerschale mit dem angebrachten oberen Kopfteil an.
- Drehe die M8 Schraube bis zum Anschlag gegen das obere Kopfteil.
- Bringe den anderen Lagerschalenabzieher über der anderen Lagerschale an.
- Ziehe die M8 Schraube vollständig fest, bis sie gegen die andere Seite zu drücken beginnt. Sie berührt das Innere des oberen Kopfteils.
- Drehe weiter, bis eine der Schalen vollständig herausgedrückt ist.
- Führe danach den Durchschlag durch die Dämpferaufnahme und setze ihn fest gegen die noch in die Dämpferaufnahme eingepresste Lagerschale.
- Schlage mit einem Hammer vorsichtig, aber fest auf den Durchschlag, bis die Lagerschale vollständig von der Dämpferaufnahme entfernt ist.

Wenn du keinen Rocky Mountain Lagerbuchsen-Werkzeugsatz hast, verwende ein Innenlagerabzieher:

- Verwende einen Innenlagerabzieher (8 mm Aufsatz) für den Ausbau beider Lager. Bringe das obere Kopfteil an einer Seite der Lagerbuchse an.
- Entferne die mittlere Hülse.
- Verwende den Innenlagerabzieher (10 mm Aufsatz) für den Ausbau der leeren Schalen.

HINWEIS: Der Innendurchmesser der Schalen beträgt 11 mm, das bedeutet, dass der 12 mm Aufsatz nicht passt (wende also keine Gewalt an). Verwende den 10 mm Aufsatz.

Verwende für den Einbau neuer Schalen eine Lagerpresse oder einen Schraubstock mit weichen Backen. Stelle sicher, dass du auf den Außenrand der Schalen drückst, und vergiss die mittlere Distanzhülse zwischen den Schalen nicht.

EINRICHTUNG DES FEDERUNGSSYSTEMS

Bevor du deine Dämpfereinstellungen änderst, solltest du dich über die verschiedenen Einstellmöglichkeiten informieren.

Einstellung der Feder

Je nach Dämpfermodell muss du möglicherweise die Schraubenfederrate oder den Luftdruck anpassen, um den für das Altitude empfohlenen Sag (Negativfederweg) zu erreichen. In der untenstehenden Tabelle findest du Empfehlungen zu den Schraubenfederraten und Luftdruckwerten.

Zugstufe

Über die Zugstufe erfolgt die Einstellung, wie schnell deine Federung wieder vollständig ausfedert, wenn sie auf eine Bodenwelle trifft. Bei einer zu starken Zugstufeneinstellung bewegen sich die Gabel oder der Dämpfer zu langsam, sie sinken bei wiederholten Wellen immer tiefer ein, was als hart empfunden wird. Ist die Zugstufe zu gering, kann die Federung zu schnell zurückspringen, was zu Traktions- und Kontrollverlust führt.

- Der Low Speed Rebound (LSR) beschreibt eine langsame Gabel- oder Dämpferbewegung und bezieht sich nicht auf die Fahrgeschwindigkeit. Diese Einstellung wirkt sich auf die Zugstufenrate im ersten Teil des Federwegs aus. Wir können dabei von 0 % bis 40 % Federweg ausgehen.
- Der High Speed Rebound (LSR) beschreibt eine schnelle Gabel- oder Dämpferbewegung und bezieht sich nicht auf die Fahrgeschwindigkeit. Diese Einstellung wirkt sich auf die Zugstufenrate im zweiten Teil des Federwegs aus. Wir können dabei von 40 % bis 100 % Federweg ausgehen.

Druckstufe

Über die Druckstufe erfolgt die Einstellung, wie schnell sich das Federungssystem bei einem Aufschlag in den Federweg bewegt. Bei einer zu starken Druckstufeneinstellung bewegen sich die Gabel oder der Dämpfer zu langsam und die Kraft des Aufpralls wird zu sehr vom Reifen und von deinem Körper absorbiert. Ist die Druckstufe zu gering, bewegen sich die Gabel oder der Dämpfer zu schnell und das Fahrgefühl wird träge und ohne Ansprechverhalten.

- Low Speed Compression (LSC) beschreibt eine langsame Gabel- oder Dämpferbewegung und bezieht sich nicht auf die Fahrgeschwindigkeit. Sie reagiert auf Gewichtsverlagerungen des Fahrers, Wippen, G-Outs und andere langsame Einflüsse. Zu viel LSC führt zu einem härteren Fahrgefühl. Bei zu wenig LSC wird das Fahrgefühl zu weich und ohne Ansprechverhalten. LSC ist auf dem gesamten Federweg wirksam.
- High Speed Compression (HSC) beschreibt eine schnelle Gabel- oder Dämpferbewegung und bezieht sich nicht auf die Fahrgeschwindigkeit. Sie ermöglicht die Absorption großer Stöße, wie z. B. bei kantigen Felsen und Durchschlägen. Zu viel HSC führt zu einem härteren Fahrgefühl auf schnellen, rauen Trails mit vielen großen Hindernissen; zu wenig HSC hingegen bietet unzureichende Unterstützung bei diesen großen Hindernissen und kann dazu führen, dass der gesamte Federweg genutzt wird.

Hydraulic Bottom Out

Das Hydraulic Bottom Out (HBO) bezieht sich auf den Durchschlagswiderstand, den einige Dämpfer in Kombination mit einem externen Einstellungssystem bieten können. Dieser wirkt sich auf die letzten 20 % des Federwegs aus und wird bei starken Stößen verwendet, bei denen es zum Dämpferdurchschlag kommen kann.

In den folgenden Tabellen findest du alle OEM-Dämpferkonfigurationen für das Altitude. Weil das Altitude mit einer Vielzahl von Dämpfern kompatibel ist, können wir hier nur die Anleitung für das Einrichten des OEM-Modells bereitstellen.

EINRICHTUNG DES FEDERUNGSSYSTEMS

Schreibe dir bei der Einstellung deiner Federung deine Einstellungen auf, damit du auf sie zurückgreifen kannst. Noch besser ist die Verwendung einer Online-Tabelle auf deinem Telefon!

Der Ausbau des Dämpfers beim Altitude mit dem LC2R-Federungssystem kann zusätzliche Schritte erfordern. Unten wird der Ausbau Schritt für Schritt erklärt. Für den Einbau folgst du einfach den Anweisungen in umgekehrter Reihenfolge. Beachte unbedingt die Anziehdrehmomente in der Kleinteileliste, die der PDF mit der Explosionszeichnung beiliegt.

1. Schalte auf das kleine Ritzel der Kassette herunter und stelle den Schaltwerkskäfig in der offenen Position fest, falls möglich.
2. Baue das Laufrad aus.
3. Vergewissere dich, dass Rahmenbereiche zwischen Sitzrohr und Link sauber und frei von Verschmutzungen sind.
4. Baue die vordere Dämpferschraube aus.
 - Vergiss nicht, das hintere Rahmendreieck abzustützen, sobald die vordere Dämpferhardware ausgebaut ist, und ziehe es vorsichtig nach hinten, bis die Sattelstrebenbrücke das Sitzrohr berührt.
5. Entferne die hintere Dämpferschraube.
 - Falls erforderlich, kannst du die RIDE4-Chip-Einsätze auf beiden Seiten des Links ausbauen.
6. Nimm den Dämpfer ab.
 - Die Abstandshalter für die Lagerbuchsen auf jeder Seite werden herausfallen, also halte eine Hand unter diesen Bereich, um sie aufzufangen.

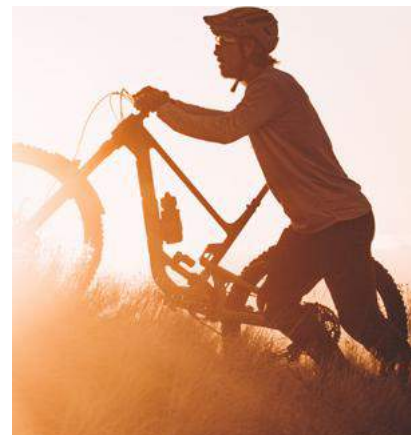

EINRICHTUNG DES FEDERUNGSSYSTEMS

2024 ALTITUDE FOX DHX2 FEDERDÄMPFER

DÄMPFERABMESSUNGEN SM = 210 X 55 MM MD - XL = 230 X 60 MM
 DÄMPFEREINSTELLUNGEN CX001, JCR010, REZI BX001
 HINWEISE *ZÄHLE KLICKS VON GESCHLOSSEN: 0 KLICKS = GESCHLOSSEN*

FAHRERGE- WICHT	STAHLFEDER	FOX SLS FEDER	DÄMPFER-SAG	LSR	HSR	LSC	HSC
100lbs 45kg	300	275		10-11	6-7	14-15	6-7
110lbs 50kg	300	300		9--11	6-7	14-15	6-7
120lbs 55kg	350	325		8-9	6-7	14-15	6-7
130lbs 59kg	350	350		8-10	6-7	13-14	6-7
140lbs 64kg	400 (SM)	375		6-7	5-6	12-13	5-6
150lbs 68kg	400	400		6-7	5-7	11-13	5-6
160lbs 73kg	450 (MD)	425	SM	5-6	4-5	9-10	5-6
170lbs 77kg	450	450	16 - 19mm	5-6	4-5	9-11	4-6
180lbs 82kg	500 (LG)	475	MD - XL	4-5	4-5	9-10	4-5
190lbs 86kg	500	500	19 - 21mm	4-5	3-5	7-9	3-4
200lbs 91kg	550 (XL)	525		3-4	3-4	6-7	3-4
210lbs 95kg	600	550		2-3	2-3	5-6	2-3
220lbs 100kg	600			2-3	2-3	5-6	2-3
230lbs 105kg	650			1-2	1-2	4-5	1-2
240lbs 109kg	700	Nicht verfügbar		1-2	0-1	3-4	0-1
250lbs 114kg	700			1-2	0-1	3-4	0-1

2024 ALTITUDE FOX DHX FEDERDÄMPFER

DÄMPFERABMESSUNGEN SM = 210 X 55 MM MD - XL = 230 X 60 MM
 DÄMPFEREINSTELLUNGEN CMSSB027, RF, REZI BVMLHB03LM
 HINWEISE *ZÄHLE KLICKS VON GESCHLOSSEN: 0 KLICKS = GESCHLOSSEN*

FAHRERGE- WICHT	STAHLFEDER	FOX SLS FEDER	DÄMPFER-SAG	LSR	HSR	LSC	HSC
100lbs 45kg	300	275		10		9 - Open	
110lbs 50kg	300	300		10		9	
120lbs 55kg	350	325		10 - 9		8 - 9	
130lbs 59kg	350	350		9		8	
140lbs 64kg	400 (SM)	375		9 - 8		7 - 8	
150lbs 68kg	400	400		8		7	
160lbs 73kg	450 (MD)	425	SM	8 - 7		6 - 7	
170lbs 77kg	450	450	16 - 19mm	7		6	
180lbs 82kg	500 (LG)	475	MD - XL	7 - 6	Nicht verfügbar	5 - 6	Nicht verfügbar
190lbs 86kg	500	500	19 - 21mm	6		5	
200lbs 91kg	550 (XL)	525		6 - 5		4 - 5	
210lbs 95kg	600	550		5		4	
220lbs 100kg	600			5 - 4		3 - 4	
230lbs 105kg	650			4		3	
240lbs 109kg	700	Nicht verfügbar		4 - 3		2 - 3	
250lbs 114kg	700			3		2	

EINRICHTUNG DES FEDERUNGSSYSTEMS

2024 ALTITUDE FOX FLOAT X2 LUFTDÄMPFER

DÄMPFERABMESSUNGEN SM = 210 X 55 MM MD - XL = 230 X 60 MM
 DÄMPFEREINSTELLUNGEN 0,3 SPACER X1, CX001, JCR010, REZI BX001
 HINWEISE *ZÄHLE KLICKS VON GESCHLOSSEN: 0 KLICKS = GESCHLOSSEN*

FAHRERGE- WICHT	STAHLFEDER	DÄMPFER-SAG	LSR	HSR	LSC	HSC
100lbs 45kg	120psi 8.3bar		11-13	5-6	14-16	6-7
110lbs 50kg	130psi 9bar		10-12	5-6	13-15	6-7
120lbs 55kg	140psi 9.7bar		9-11	4-5	13-15	6-7
130lbs 59kg	150psi 10.3bar		8-10	4-5	12-14	5-6
140lbs 64kg	160psi 11bar		7-9	4-5	11-13	5-6
150lbs 68kg	170psi 11.7bar		7-9	3-4	10-12	5-6
160lbs 73kg	180psi 12.4bar	SM	6-8	3-4	9-11	4-5
170lbs 77kg	190psi 13.1bar	16 - 19mm	6-8	3-4	8-10	4-5
180lbs 82kg	200psi 13.8bar	MD - XL	5-7	2-3	7-9	4-5
190lbs 86kg	210psi 14.5bar	19 - 21mm	4-6	2-3	6-8	4-5
200lbs 91kg	220psi 15.2bar		3-5	2-3	5-7	3-4
210lbs 95kg	230psi 15.9bar		2-4	2-3	4-6	3-4
220lbs 100kg	240psi 16.5bar		2-4	1-2	2-4	3-4
230lbs 105kg	250psi 17.2bar		1-3	1-2	2-4	3-4
240lbs 109kg	260psi 17.9bar		1-3	1-2	2-4	2-3
250lbs 114kg	270psi 18.6bar		1-2	1-2	1-3	1-2

2024 ALTITUDE FOX FLOAT X LUFTDÄMPFER

DÄMPFERABMESSUNGEN SM = 210 X 55 MM MD - XL = 230 X 60 MM
 DÄMPFEREINSTELLUNGEN 0,4 SPACER, CMSSB024, RM, REZI BVMLHB01LM
 HINWEISE *ZÄHLE KLICKS VON GESCHLOSSEN: 0 KLICKS = GESCHLOSSEN*

FAHRERGE- WICHT	STAHLFEDER	DÄMPFER-SAG	LSR	HSR	LSC	HSC
100lbs 45kg	120psi 8.3bar		10		9 - Open	
110lbs 50kg	130psi 9bar		10		9	
120lbs 55kg	140psi 9.7bar		10 - 9		8 - 9	
130lbs 59kg	150psi 10.3bar		9		8	
140lbs 64kg	160psi 11bar		9 - 8		7 - 8	
150lbs 68kg	170psi 11.7bar		8		7	
160lbs 73kg	180psi 12.4bar	SM	8 - 7		6 - 7	
170lbs 77kg	190psi 13.1bar	16 - 19mm	7		6	
180lbs 82kg	200psi 13.8bar	MD - XL	7 - 6	Nicht verfügbar	5 - 6	Nicht verfügbar
190lbs 86kg	210psi 14.5bar	19 - 21mm	6		5	
200lbs 91kg	220psi 15.2bar		6 - 5		4 - 5	
210lbs 95kg	230psi 15.9bar		5		4	
220lbs 100kg	240psi 16.5bar		5 - 4		3 - 4	
230lbs 105kg	250psi 17.2bar		4		3	
240lbs 109kg	260psi 17.9bar		4 - 3		2 - 3	
250lbs 114kg	270psi 18.6bar		3		2	

HTUNG DES FEDERUNGSSYSTEMS

2024 ALTITUDE ROCK SHOX SUPER DELUXE LUFTDÄMPFER

DÄMPFERABMESSUNGEN SM = 210 X 55 MM MD - XL = 230 X 60 MM
 DÄMPFEREINSTELLUNGEN OL1 PRM 32SN
 HINWEISE *ZÄHLE KLICKS VON GESCHLOSSEN: 0 KLICKS = GESCHLOSSEN*

FAHRERGE- WICHT	STAHLFEDER	DÄMPFER-SAG	LSR	HSR	LSC	HSC
100lbs 45kg	110psi 7.6bar		11-12			
110lbs 50kg	120psi 8.3bar		10-11			
120lbs 55kg	130psi 9bar		9--11			
130lbs 59kg	140psi 9.7bar		8-9	Starte bei neutraler Einstellung (3. Position)	Starte bei neutraler Einstellung (3. Position)	
140lbs 64kg	150psi 10.3bar		8-10	Nimm die Einstellung klickweise vor, bis das gewünschte Bottom-Out-Gefühl erreicht ist. Das optionale Hydraulic Bottom Out drosselt den Öldurchfluss in den letzten 20 % des Federwegs und sorgt für eine weiche hydraulische Dämpfung, die ein hartes Durchschlagen verhindert.	Nimm die Einstellung klickweise vor, um die gewünschte Unterstützung bei Bewegungen mit niedriger Wellendrehzahl zu erzielen, z. B. beim Fahren über Bodenwellen mit Pump-Technik, beim Vorspannen für einen Sprung oder Drop oder für mehr Unterstützung bei Anstiegen.	Starte bei neutraler Einstellung (3. Position)
150lbs 68kg	160psi 11bar	SM	6-7			Nimm die Einstellung klickweise vor, um die gewünschte Unterstützung bei Bewegungen mit hoher Wellendrehzahl zu erhalten, wie z. B. bei Hindernissen mit felsigem Terrain und bei großen Drops.
160lbs 73kg	170psi 11.7bar	16 - 19mm	6-7			
170lbs 77kg	180psi 12.4bar		5-6			
180lbs 82kg	190psi 13.1bar	MD - XL	5-6			
190lbs 86kg	200psi 13.8bar	19 - 21mm	4-5			
200lbs 91kg	210psi 14.5bar		4-5			
210lbs 95kg	220psi 15.2bar		3-4			
220lbs 100kg	230psi 15.9bar		2-3			
230lbs 105kg	240psi 16.5bar		2-3			
240lbs 109kg	250psi 17.2bar		1-2			
250lbs 114kg	260psi 17.9bar		1-2			

2024 ALTITUDE ROCK SHOX SUPER DELUXE COIL SHOCK

DÄMPFERABMESSUNGEN SM = 210 X 55 MM MD - XL = 230 X 60 MM
 DÄMPFEREINSTELLUNGEN PRM 32SN
 HINWEISE *ZÄHLE KLICKS VON GESCHLOSSEN: 0 KLICKS = GESCHLOSSEN* DIE SCHRAUBENFEDERRATEN VON ROCK SHOX SIND BEI GLEICHER RAHMENGRÖSSE 50# NIEDRIGER ALS BEI FOX. DER UNTERSCHIED LIEGT IN DER KONSTRUKTION UND DER GEWÄHLTEN EINSTELLUNG DES ROCK SHOX DÄMPFERS.

FAHRERGE- WICHT	STAHLFEDER	DÄMPFER-SAG	LSR	HSR	LSC	HSC
100lbs 45kg	300		11-12			
110lbs 50kg	300		10-11			
120lbs 55kg	300		9--11			
130lbs 59kg	350		8-9	Starte bei neutraler Einstellung (3. Position)	Starte bei neutraler Einstellung (3. Position)	
140lbs 64kg	350 (SM)		8-10	Nimm die Einstellung klickweise vor, bis das gewünschte Bottom-Out-Gefühl erreicht ist. Das optionale Hydraulic Bottom Out drosselt den Öldurchfluss in den letzten 20 % des Federwegs und sorgt für eine weiche hydraulische Dämpfung, die ein hartes Durchschlagen verhindert.	Nimm die Einstellung klickweise vor, um die gewünschte Unterstützung bei Bewegungen mit niedriger Wellendrehzahl zu erzielen, z. B. beim Fahren über Bodenwellen mit Pump-Technik, beim Vorspannen für einen Sprung oder Drop oder für mehr Unterstützung bei Anstiegen.	Starte bei neutraler Einstellung (3. Position)
150lbs 68kg	400	SM	6-7			Nimm die Einstellung klickweise vor, um die gewünschte Unterstützung bei Bewegungen mit hoher Wellendrehzahl zu erhalten, wie z. B. bei Hindernissen mit felsigem Terrain und bei großen Drops.
160lbs 73kg	400(MD)	16 - 19mm	6-7			
170lbs 77kg	450		5-6			
180lbs 82kg	450 (LG)	MD - XL	5-6			
190lbs 86kg	500	19 - 21mm	4-5			
200lbs 91kg	500 (XL)		4-5			
210lbs 95kg	550		3-4			
220lbs 100kg	600		2-3			
230lbs 105kg	600		2-3			
240lbs 109kg	650		1-2			
250lbs 114kg	700		1-2			

KABELFÜHRUNG - ANLEITUNG

Diese Anleitung gilt sowohl für Carbon als auch für Alloy Altitude Rahmen. Die Anleitungen für die einzelnen Rahmendesigns unterscheiden sich geringfügig, daher solltest du die für deinen speziellen Rahmen geltenden Anweisungen genau beachten.

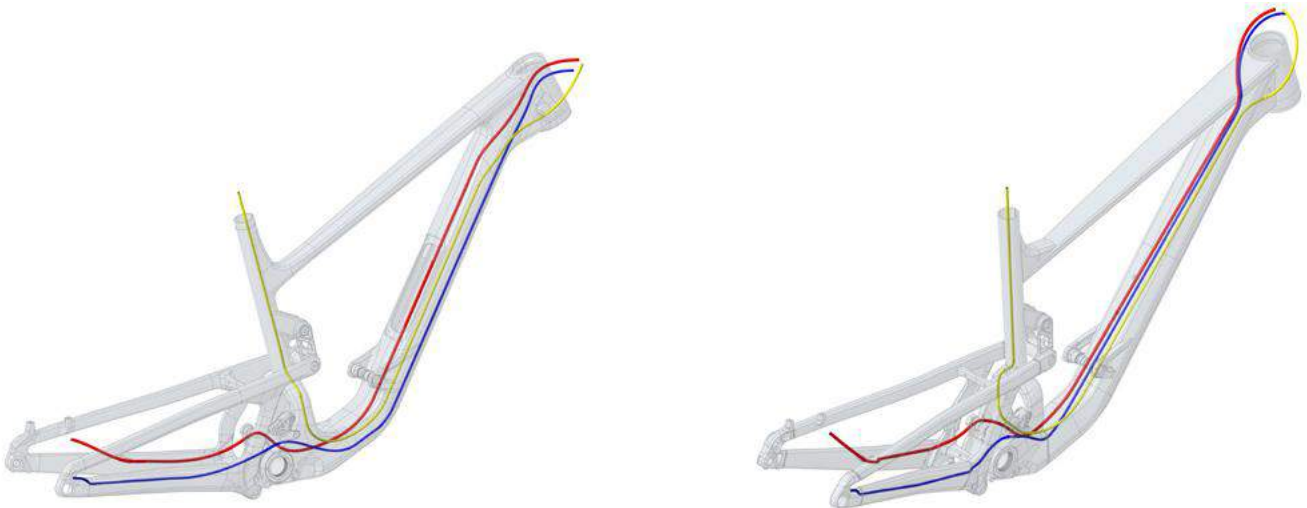

Durch den Ausbau des Hinterrads und des Dämpfers kannst du das hintere Rahmendreieck drehen und hast besseren Zugang für die Ausrichtung der Kabelhüllen im Bereich zwischen dem hinteren und vorderen Rahmendreieck.

Die Kanäle in den Rohren in der Kettenstrebe können teilweise eng sein, insbesondere wenn sie gebogene Bereiche durchlaufen. Sprühe Seifenwasser oder Isopropylalkohol als Schmiermittel in die Öffnung, um das Einziehen der Kabelhülle von einem Ende zum anderen zu erleichtern. Verwende kein Fett oder Öl; das verschmiert und Schmutz bleibt daran kleben.

Der Alloy-Rahmen hat keine internen Führungen für Kabelhüllen. Es werden Werkzeuge benötigt, wie z. B. das IR-1.2 Montage-Set für interne Kabelführung von Park Tool, das bei der Führung aller Kabelhüllen in und aus dem Rahmen hilft. Wir empfehlen, das IR-1.2-Kabel in umgekehrter Reihenfolge zu installieren, indem du den mit der neuen Kabelhülle verbundenen Gewindewiderhaken verwendest und die Kabelhülle vorsichtig in Richtung des vorderen Rahmentails ziehst.

AUSTAUSCH/EINBAU KABELHÜLLE SCHALTWERK

Wenn du eine alte Kabelhülle austauschst, ziehe diese heraus und schneide ein neues Stück gleicher Länge ab. Wenn du das alte Stück nicht hast, schätze die erforderliche Länge und schneide ein etwas längeres Stück ab.

- 1.** Entferne die Abdeckung der Öffnung am Oberrohr auf der Nichtantriebsseite. *opposé à la transmission.*

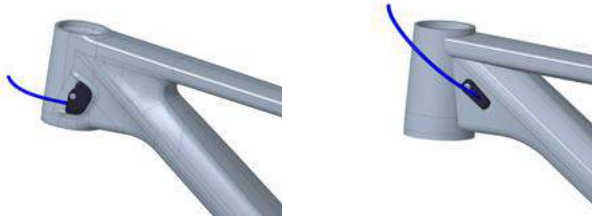

- 2.** Beginne am hinteren Ende des Fahrrades mit dem Einführen der Kabelhülle in die Kabelöffnung an der Kettenstrebe auf der Antriebsseite. Schiebe die Kabelhülle vor und verdrehe sie gleichzeitig, bis sie am vorderen Ende der Kettenstrebe austritt.



- 3.** Führe die Kabelhülle in die Kabelöffnung über dem Tretlager ein. Stelle sicher, dass du die Kabelhülle des Schaltwerks in die Öffnung auf der Antriebsseite einführst.



- 4.** Schiebe das Kabel von hinten hinein, bis es an der Öffnung am Oberrohr austritt.

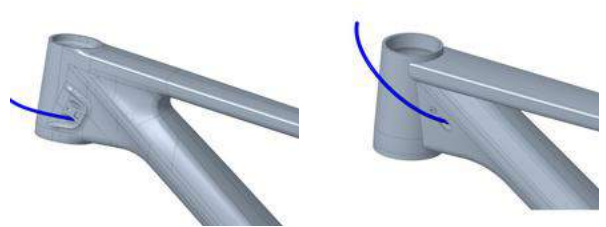

- 5.** Setze die Abdeckung für die Oberrohröffnung wieder ein, nachdem die Kabelhülle vollständig zwischen dem Schalthebel und dem Schaltwerk installiert ist. Achte bei Alloy-Rahmen darauf, dass du die dem Rahmen beiliegende 4 mm dicke Schaumstoffhülle installierst. Es kann sein, dass die ursprüngliche Schaumstoffhülle in den Rahmen gefallen ist und du sie bei einem Austausch vorsichtig herausfischen musst.

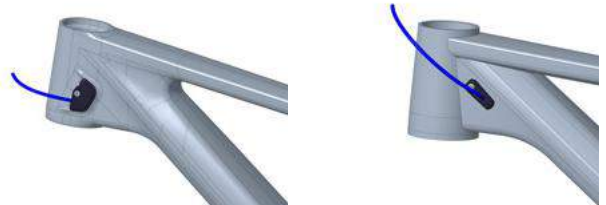

- 6.** Achte beim Alloy-Rahmen darauf, dass du die Kabelhülle an der Führung auf der Innenseite des Dämpfertunnels befestigst. Dadurch wird verhindert, dass die Kabelhülle den Stoßdämpfer berührt.



STAUSCH/EINBAU KABELHÜLLE VARIO-SATTELSTÜTZE

1. Entferne je nach Lage der hinteren Bremsleitung die Abdeckung an der Oberrohröffnung auf der Antriebs- oder Nichtantriebsseite.



2. Für Carbon: Beginne an der Öffnung am Oberrohr mit dem Einführen der Kabelhülle in die untere Kabelöffnung. Schiebe die Kabelhülle vor, bis sie am Sattelrohr austritt.



3. Für Alloy: Führe die Kabelhülle an der Sitzrohröffnung ein und führe es dann in die Öffnung am Unterrohr.



4. Für Alloy: Führe die Kabelhülle ein, bis sie aus der Oberrohröffnung herausragt. Vergiss nicht, die dem Rahmen beiliegende 4 mm dicke Schaumstoffhülle zu installieren. Es kann sein, dass die bestehende Schaumstoffhülle in den Rahmen gefallen ist und du sie bei einem Austausch vorsichtig herausfischen musst.



5. Schließen Sie den Einbau der Vario-Sattelstütze gemäß Herstelleranweisungen ab.

6. Bringe nach dem korrekten Einbau der Sattelstütze die Öffnung am Oberrohr wieder an.

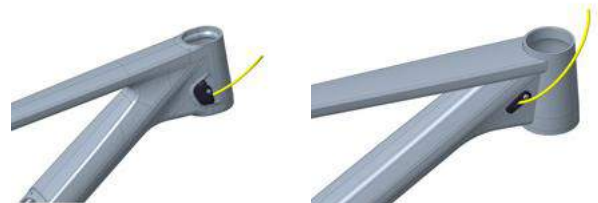

7. Achte beim Alloy-Rahmen darauf, dass du die Kabelhülle an der Führung auf der Innenseite des Dämpfertunnels befestigst. Dadurch wird verhindert, dass die Kabelhülle den Stoßdämpfer berührt.



AUSTAUSCH/EINBAU HYDRAULISCHE BREMSLEITUNG HINTEN

1. Entferne je nach Lage der hinteren Bremsleitung die Abdeckung an der Oberrohröffnung auf der Antriebs- oder Nichtantriebsseite.

Reguläre Kabelführung = Nichtantriebsseite

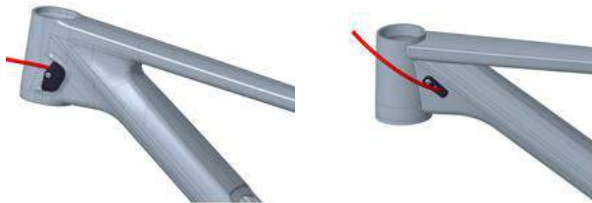

Moto- | UK/AUS-Kabelführung = Antriebsseite

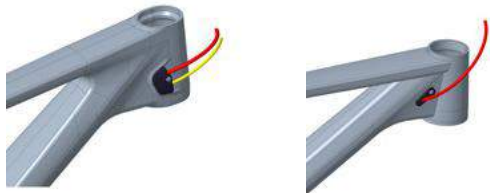

2. Bei Alloy-Rahmen: Entferne die Abdeckung an der Innenseite der Kettenstrebe.



3. Beginne hinten am Rahmen und schiebe die Bremsleitung nach vorne, bis sie am vorderen Ende der Kettenstrebe herausragt.

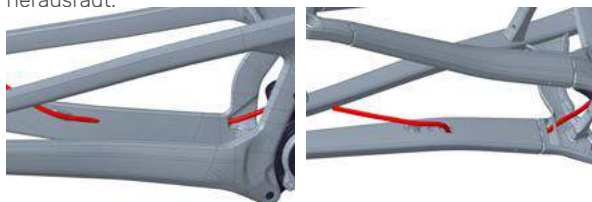

4. Führe die Bremsleitung in die Kabelöffnung über dem Tretlager ein. Achte darauf, dass du die Bremsleitung (rot) in die Öffnung auf der Nichtantriebsseite einführst.

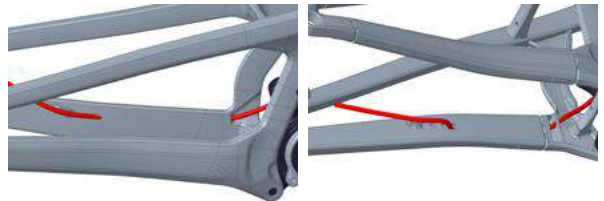

5. Bei Carbon-Rahmen: Nimm die Penalty Box-Abdeckung ab, um Zugang zu den inneren Kabelhüllen zu erhalten. Führe die Bremsleitung an der Unterbrechung der Kabelhülle in den gewünschten Kanal. Der untere Kanal ist für die Standardposition des hinteren Bremshebels vorgesehen. Die Bremsleitung wird auf der Nichtantriebsseite des Rahmens herausgezogen und wird dann auf der rechten Seite zum Hebel geführt. Der obere Kanal ist für die Moto | UK/AUS-Position (linke Seite) des hinteren Bremshebels vorgesehen.

Reguläre Kabelführung = Unterrohr



Moto- | UK/AUS -Kabelführung = Oberrohr

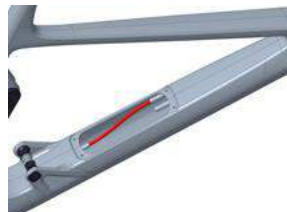

AUSTAUSCH/EINBAU HYDRAULISCHE BREMSLEITUNG HINTEN

6. Schiebe die Bremsleitung von hinten hinein, bis sie an der Öffnung am Oberrohr austritt.

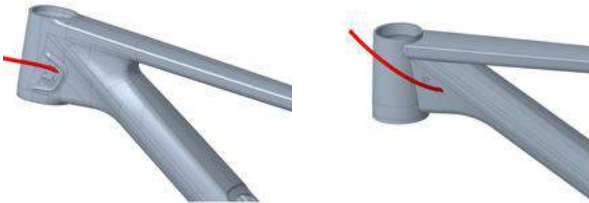

7. Bei Alloy-Rahmen: Führe die Kabelhülle ein, bis sie aus der Oberrohröffnung herausragt. Vergiss nicht, die dem Rahmen beiliegende 5 mm dicke Schaumstoffhülle zu installieren. Es kann sein, dass die ursprüngliche Schaumstoffhülle in den Rahmen gefallen ist und du sie bei einem Austausch vorsichtig herausfischen musst.

8. Bringe die Abdeckung an der Oberrohröffnung wieder an, nachdem die Bremsleitung installiert ist.

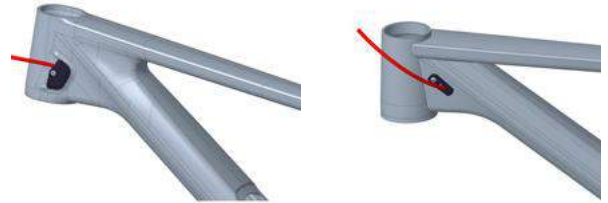

9. Achte beim Alloy-Rahmen darauf, dass du die Kabelhülle an der Führung auf der Innenseite des Dämpfertunnels befestigst. Dadurch wird verhindert, dass die Kabelhülle den Stoßdämpfer berührt.



WICHTIGE ABMESSUNGEN

ARTIKEL-NUMMER	KATEGORIE	ARTIKEL	ABMESSUNG	TEILENUMMER	BESCHREIBUNG
1	Steuersatz	Steuersatz Carbon-Rahmen	FSA No.85-10mm Offset		FSA Nr. 85-10 mm Offset-Steuersatz, komplett. Siehe Steuersatz-Tabelle für Informationen
		Lagerschalensatz Carbon-Rahmen	FSA No.85-15mm Offset		FSA Nr. 85-15 mm Offset (nur Lagerschalen). Siehe Steuersatz-Tabelle für Informationen
		Steuersatz Alloy-Rahmen	FSA ZS56 66 0mm Offset		FSA RMB ZS56 66 0 mm Offset Steuersatz, komplett. Siehe Steuersatz-Tabelle für Informationen
		Lagerschalensatz Alloy-Rahmen	FSA ZS56 66 5mm Offset		FSA RMB ZS56 66 5-mm Offset (nur Lagerschalen). Siehe Steuersatz-Tabelle für Informationen
2	Gabel	Gabelfederweg	170mm		
		Gabelversatz	SM = 37mm		
		Maximale Einbauhöhe	MD - LG - XL = 42 - 44mm		
			SM = 567mm MD - LG - XL = 586mm		
3	Dämpfer	Dämpfer	SM = 210 x 55mm MD - LG - XL = 230 x 60mm		MD - LG - XL-Rahmen sind kompatibel mit 210 x 55 mm
		Dämpfereinstellung	See Description		Informationen zum Setup findest Du in der Tabelle zur Dämpfereinstellung
		Dämpferhardware Vorderbau	40 x 10mm		Erfordert kundenspezifische Hardware. Siehe Dämpferhardware-Tabelle für Informationen
		Dämpferhardware Hinterbau	35 x 8mm	1811007	Erfordert kundenspezifische Lageraufnahmehardware. Siehe Dämpferhardware-Tabelle für Informationen
		Geprüfte Dämpfermodelle	Siehe Beschreibung		Alle Fox Dämpfermodelle für den Hinterbau Alle Rock Shox Dämpfermodelle für den Hinterbau
4	Tige de selle	Innendurchmesser Sitzrohr	30.9mm		Für die Dimensionierung der Sattelstütze
		Außendurchmesser Sitzrohr	34.9mm		Für die Dimensionierung der Sattellekme
		Mindest-Einschubtiefe Sitzrohr	100mm		
		Aufgeriebene Einschubtiefe Sitzrohr	SM = 202 192mm MD = 250 240mm		Informationen zur Passung der Sattelstütze findest du im entsprechenden Abschnitt in dieser Bedienungsanleitung.
		Carbon Alloy	LG = 280 270mm XL = 310 300mm		

WICHTIGE ABMESSUNGEN

ARTIKEL-NUMMER	KATEGORIE	ARTIKEL	ABMESSUNG	TEILENUMMER	BESCHREIBUNG
5	Kurbelsatz	Größenbereich Kettenblatt	Minimum = 30 Maximum = 34D		
		Größe Länge OEM Kettenblatt	SM = 32 T 116 L		
		Kettenführungssatz	MD = 32 T 118 L		
		Kettenführung	LG - XL = 32 T 120 L	TBD	Kompatibel mit Altitude-spezifischem Canadarm 2.0 + OneUp Components obere Führung
		Bashguard	Siehe Beschreibung	IC0686	Für Einzelteile siehe Explosionszeichnung.
		Tretlager	2-Bolt ISCG05		Befestigungsmuster ISCG05 Zweischraubensystem, nur für Bashguards
		Kettenlinienbereich	BSA 73mm		
		Chainline Range	52 - 55mm		
6	Bremsen	Diamètre de disque maximal	220mm		
		Laufgrad	2.3mm		
7	Laufgrad	Wheel Size	SM = 27.5"		
			MD - LG - XL = 29"		Kompatibel mit MX/Mullet-Laufgradsetup durch Flip-Chip
8	Hinterradnabe	Maximale Reifenbreite	2.5" 63mm		
		Nabenabstand	12 x 148mm		
		Hinterachse	12 x 1.0 x 173mm		Durchmesser 12 mm x Gewindesteigung 1,0 mm x Länge 173 mm
		Ersatz-Achse	Siehe Beschreibung	3222000	Durchmesser 12 mm x Gewindesteigung 1,0 mm x Länge = 173 mm
		Schaltauge Komplettsset	Siehe Beschreibung	1812002	Inklusive Schaltauge, Mutter und Unterlegscheibe. Für Einzelteile siehe Explosionszeichnung.
		SRAM UDH Transmission	Siehe Beschreibung		Rahmen ist mit SRAM UDH und Transmission kompatibel

EXPLOSIONSZEICHNUNG

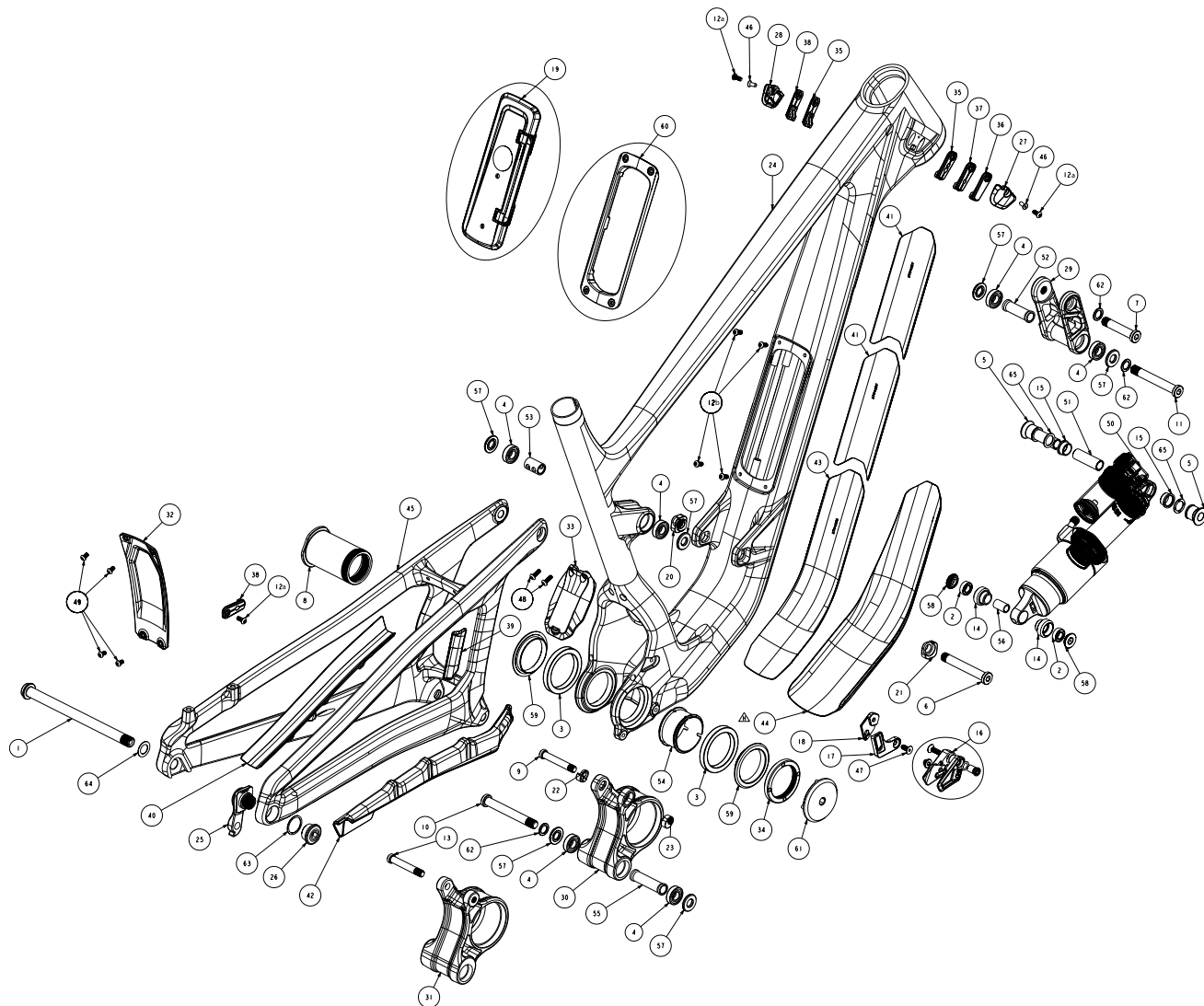

TEILELISTE UND MONTAGEANLEITUNG

#	QTY	ITEM	PART NO.	TORQUE (Nm)	INSTALLATION NOTES	
					DESCRIPTION	INSTALLATION NOTES
1	1	AXLE, REAR	3222000	10	REAR AXLE 12X1.0 L:173MM, HARD BLACK ANODIZE	Apply grease to axle shaft and threads. Use
2	2	BEARING	1801010		ENDURO 688 LLU MAX 16X8X5	
3	2	BEARING	1804045		24ASPT ALTITUDE MP BEARING 6809 45X58X7	
4	6	BEARING	1807042		ENDURO BEARING 6900 2RS MAX TYPE, 22X10X6 SIZE	
5	2	BEARING SPACER	1804049		FORWARD SHOCK REDUCER 10 MM THRU	
6	1	BOLT	1804033	10	FORWARD SHOCK BOLT, M10x1.0, L:72	Apply grease to pivot bolts, and Loctite 243
7	1	BOLT	1804036	10	TOP LINK, TOP BOLT, M10x1.0, L:51, 6MMHEX	Apply grease to pivot bolts, and Loctite 243
8	1	BOLT	1804037		MAIN PIVOT BOLT (M43x1.5, OD: 43, L:70, ID BSA)	Apply grease to MP bolt and screw threads.
9	1	BOLT	1804040	10	LOWER LINK SHOCK BOLT, M8x1.0, L:51	Apply grease to pivot bolts, and Loctite 243
10	1	BOLT	1804047	10	LOWER LINK LOWER BOLT M10x1.0, L81.5	Apply grease to pivot bolts, and Loctite 243
11	1	BOLT	1804053	10	TOP LINK LOWER BOLT M10x1.0, L74	Apply grease to pivot bolts, and Loctite 243
12	7	BOLT	1804060	< 1	M4x0.7 10MM HEX BUTTON HEAD	a) Apply grease (alloy only). b) Apply Loctite 243 (blue) (carbonyl)
13	1	BOLT	1805169	10	LOWER 27.5 LINK SHOCK BOLT, M8x1.0, L:51, 11 MM THREAD	Apply grease to pivot bolts, and Loctite 243
14	2	BRG CUP	1800031		BEARING EYELET FOR 16x8X5 BRG	
15	2	BUSHING, FOX	N/A		FOX_LIGUS_BUSHING	
16	1	CHAINGUIDE	3391004		ONEUP CHAINGUIDE ASSEMBLY (1C0686)	
17	1	CHAINGUIDE BA	1394003		BASEPLATE FOR CHAINGUIDE	
18	1	CHAINGUIDE SLII	3391002		SLIDING PART OF CHAINGUIDE	
19	1	COMPLETE COVER	1994031		PENALTYBOX 2 COMPLETE COVER SUB-ASSEMBLY	Carbon only.
20	1	FLIP CHIP	1804032		RIDE 4 CHIP - THREADED, M10x1.0, T:10	
21	1	FLIP CHIP	1804034		RIDE 4 CHIP - 10 mm THRU	
22	1	FLIP CHIP	1804041		LOWER LINK FLIP CHIP 29 AND MX	
23	1	FLIP CHIP	1804043		LOWER LINK CHIP THREAD, M8x1.0, 29 OR MX	
24	1	FRONT TRIANGLE	B064112CBN		2024 ALTITUDE CARBON FRONT TRIANGLE - SIZE LARGE	
25	1	HANGER	1092003		MY22 REAR DER. HANGER, M12X1, UDH COMPATIBLE	
26	1	HANGER NUT	1801008	20	RMB UDH HANGER NUT, 7075_T6, HARD BLACK ANODIZED	Apply Loctite 243 (blue) to threads.
27	1	HT PORT COVER	1803012		2023 SLAYER CARBON HT PORT COVER, RIGHT	Carbon only.
28	1	HT PORT COVER	1803013		2023 SLAYER CARBON HT PORT COVER, LEFT	Carbon only.
29	1	LINK	1094001		2024 ALTITUDE TOP LINK	
30	1	LINK	1094002		2024 ALTITUDE LOWER LINK, 29"	Use 1804040 shock bolt with 29/MX link.
31	1	LINK	1094003		MY24 ALTITUDE LOWER LINK, 27.5" SIZE SMALL	Use 1805169 shock bolt for 27.5" link.
32	1	MUD GUARD	1994026		2024 ALTITUDE REAR TRIANGLE MUD GUARD	
33	1	MUD GUARD	1994027		2024 ALTITUDE SHOCK MUD GUARD	
34	1	NUT	1804038	25	MP NUT M43X1.5, T:7, OD:54.5	Install using RMB BB/MP Tool (PART # 1804039).
35	2	PORT COVER	1093011		ALLOY CABLE PORT COVER DOUBLE HOLE	Alloy only.
36	1	PORT COVER	1093012		ALLOY CABLE PORT COVER BLANK	Alloy only.
37	1	PORT COVER	1093013		ALLOY CABLE PORT COVER SINGLE 4mm HOLE	Alloy only.
38	2	PORT COVER	1093014		ALLOY CABLE PORT COVER SINGLE 5mm HOLE	Alloy only.
39	1	PROTECTOR	3704055		2024 ALTITUDE CHAIN STAY UPPER PROTECTOR	
40	1	PROTECTOR	3704056		2024 ALTITUDE SEAT STAY PROTECTOR	
41	2	PROTECTOR	3704057		2024 ALTITUDE TAILGATE PROTECTOR	
42	1	PROTECTOR	3704058		2024 ALTITUDE CHAIN STAY LOWER PROTECTOR	
43	1	PROTECTOR	3704059		2024 ALTITUDE DOWN TUBE PROTECTOR	Alloy
44	1	PROTECTOR	3704108		MY24 ALTITUDE CARBON DOWN TUBE PROTECTOR	Carbon
45	1	REAR TRIANGLE	I054112CBN		2024 ALTITUDE CARBON REAR TRIANGLE - SIZE LARGE & X-LARGE	
46	2	SCREW	1800024-BK	< 1	C'SUNK SOCKET SCREW, M4x10MM, 10.9 STEEL, BLACK	Apply grease to screw threads (carbon only).
47	1	SCREW	1804055	< 2	C'SUNK SOCKET SCREW, M5X0.8, L:12 MM, 3MM HEX, SS	Apply Loctite 243 (blue) to threads.
48	2	SCREW	1804067	< 1	M4x0.7 DOME HEAD SCREW, L:12, HEX 2.5	Apply grease to screw threads.
49	4	SCREW	1804068	< 1	M4x0.7 DOME HEAD SCREW, L:7, HEX 2.5	Apply grease to screw threads.
50	1	SHOCK	N/A		REAR SHOCK, 230X60	
51	1	SHOCK, PIN	N/A		SHOCK PIN: ID:10 MM, L:40 MM, STEEL	
52	1	SLEEVE	1800010		SS BEARING SLEEVE, ID:10, OD:14, L:41, NECKED	
53	1	SLEEVE	1804035		TOP LINK UPPER SLEEVE, OD:14, ID: 10.2, L:22	
54	1	SLEEVE	1804044		MAIN PIVOT SLEEVE L:29 ID:43 OD:49	
55	1	SLEEVE	1804048		LOWER LINK SLEEVE, ID:10.2, OD:14, L:50	
56	1	SLEEVE	1807028		BEARING EYELET CENTRE SLEEVE	
57	6	SPACER	1800009		LINK BEARING SPACER, OD:22, ID:10, T:2.5	
58	2	SPACER	1804042		LOWER LINK SHOCK SPACER, 8 MM THRU	
59	2	SPACER	1804046		MP BEARING SPACER ID:45 OD:57 T:8	
60	1	SUBFRAME S-A	1814004		PENALTYBOX 2 MOUNTING FRAME	Carbon only.
61	1	TOOL	1804039		BOTTOM BRACKET TOOL	BB/MP nut installation tool. Ensure tool is
62	3	WASHER	1800019		WASHER ID: 10.2, OD: 15.5, T: 1	
63	1	WASHER	1801009		WASHER, 20X24X0.5MM, 304 SS	
64	1	WASHER	3227006		WASHER, 12x19x0.5MM, 304 SS	
65	2	WASHER	N/A		SHOCK CRUSH WASHER	
66	1	LINK	1094001P		2024 ALTITUDE TOP LINK POLISHED	
67	1	LINK	1094002P		2024 ALTITUDE LOWER LINK, 29" POLISHED	
68	1	LINK	1094003P		MY24 ALTITUDE LOWER LINK, 27.5" SIZE SMALL POLISHED	
1	1	HEAD SET CUP	1194002		FSA 5MM OFFSET OVAL CUPS W/ORING CR BIKES	
1	1	HEAD SET CUP	1194004		FSA 5MM OFFSET CUPS AL BIKES	
1	1	HEADSET	1194001		FSA NO.85 1.5" OMM OFFSET OVAL CUPS STAINLESS	
1	1	HEADSET	1194003		FSA ZS56 66 OMM OFFSET HS STAINLESS STEEL	

LISTE DER KLEINTEILE-SÄTZE

2024 ALTITUDE CARBON ALLOY					
#	QTY	ITEM	PART NO.	SUPPLIER	REVISION DESCRIPTION
1814020 ZCA013 2024 ALTITUDE UPPER LINK KIT WITH BEARINGS					
29	1	LINK	1094001	PTW385	2024 ALTITUDE TOP LINK
4	2	BEARING	1807042	PUS098	ENDURO BEARING 6900 2RS MAX TYPE, 22X10X6 SIZE
52	1	SLEEVE	1800010	PTW047	SS BEARING SLEEVE, ID:10, OD:14, L:41, NECKED
1814021 ZCA013 2024 ALTITUDE 29 LOWER LINK KIT WITH BEARINGS					
30	1	LINK	1094002	PTW385	2024 ALTITUDE LOWER LINK, 29"
4	2	BEARING	1807042	PUS098	ENDURO BEARING 6900 2RS MAX TYPE, 22X10X6 SIZE
55	1	SLEEVE	1804048	PTW047	LOWER LINK SLEEVE, ID:10.2, OD:14, L:50
3	2	BEARING	1804045	PUS098	24ASPT ALTITUDE MP BEARING 6809 45X58X7
54	1	SLEEVE	1804044	PTW047	MAIN PIVOT SLEEVE L:29 ID:43 OD:49
1814022 ZCA013 2024 ALTITUDE 27.5 LOWER LINK KIT WITH BEARINGS					
31	1	LINK	1094003	PTW385	MY24 ALTITUDE LOWER LINK, 27.5" SIZE SMALL
4	2	BEARING	1807042	PUS098	ENDURO BEARING 6900 2RS MAX TYPE, 22X10X6 SIZE
55	1	SLEEVE	1804048	PTW047	LOWER LINK SLEEVE, ID:10.2, OD:14, L:50
3	2	BEARING	1804045	PUS098	24ASPT ALTITUDE MP BEARING 6809 45X58X7
54	1	SLEEVE	1804044	PTW047	MAIN PIVOT SLEEVE L:29 ID:43 OD:49
1814020P ZCA013 2024 ALTITUDE UPPER LINK POLISHED KIT WITH BEARING					
66	1	LINK	1094001P	PTW385	2024 ALTITUDE TOP LINK POLISHED
4	2	BEARING	1807042	PUS098	ENDURO BEARING 6900 2RS MAX TYPE, 22X10X6 SIZE
52	1	SLEEVE	1800010	PTW047	SS BEARING SLEEVE, ID:10, OD:14, L:41, NECKED
1814021P ZCA013 2024 ALTITUDE 29 LOWER LINK POLISHED KT WITH BEARING					
67	1	LINK	1094002P	PTW385	2024 ALTITUDE LOWER LINK, 29" POLISHED
4	2	BEARING	1807042	PUS098	ENDURO BEARING 6900 2RS MAX TYPE, 22X10X6 SIZE
55	1	SLEEVE	1804048	PTW047	LOWER LINK SLEEVE, ID:10.2, OD:14, L:50
3	2	BEARING	1804045	PUS098	24ASPT ALTITUDE MP BEARING 6809 45X58X7
54	1	SLEEVE	1804044	PTW047	MAIN PIVOT SLEEVE L:29 ID:43 OD:49
1814022P ZCA013 2024 ALTITUDE 27.5 LOWER LINK POLISH KT WITH BEARING					
68	1	LINK	1094003P	PTW385	MY24 ALTITUDE LOWER LINK, 27.5" SIZE SMALL POLISHED
4	2	BEARING	1807042	PUS098	ENDURO BEARING 6900 2RS MAX TYPE, 22X10X6 SIZE
55	1	SLEEVE	1804048	PTW047	LOWER LINK SLEEVE, ID:10.2, OD:14, L:50
3	2	BEARING	1804045	PUS098	24ASPT ALTITUDE MP BEARING 6809 45X58X7
54	1	SLEEVE	1804044	PTW047	MAIN PIVOT SLEEVE L:29 ID:43 OD:49
1812002 PTW047 2022 HANGER KIT 12 x1.0					
25	1	HANGER	1092003	PTW047	MY22 REAR DER. HANGER, M12X1, UDH COMPATIBLE
26	1	HANGER NUT	1801008	PTW047	RMB UDH HANGER NUT, 7075_T6, HARD BLACK ANODIZED
63	1	WASHER	1801009	PTW047	WASHER, 20X24X0.5MM, 304 SS
1814018 PTW047 2024 ALTITUDE PIVOT BOLT KIT					
7	1	BOLT	1804036	PTW047	TOP LINK, TOP BOLT, M10x1.0, L:51, 6MMHEX
10	1	BOLT	1804047	PTW047	LOWER LINK LOWER BOLT M10x1.0, L81.5
11	1	BOLT	1804053	PTW047	TOP LINK LOWER BOLT M10x1.0, L74
57	6	SPACER	1800009	PTW047	LINK BEARING SPACER, OD:22, ID:10, T:2.5
62	3	WASHER	1800019	PTW047	WASHER ID: 10.2, OD: 15.5, T: 1
1814019 PTW047 2024 ALTITUDE MAIN PIVOT KIT					
8	1	BOLT	1804037	PTW047	MAIN PIVOT BOLT (M43x1.5, OD: 43, L:70, ID BSA)
34	1	NUT	1804038	PTW047	MP NUT M43X1.5, T:7, OD:54.5
59	2	SPACER	1804046	PTW047	MP BEARING SPACER ID:45 OD:57 T:8
1814023 PTW047 2024 ALTITUDE MAIN PIVOT TOOL					
61	1	TOOL	1804039	PTW047	BOTTOM BRACKET TOOL

LISTE DER KLEINTEILE-SÄTZE

		1814024	ZCA013	2024 ALTITUDE PIVOT BEARING KIT
3	2 BEARING	1804045	PUS098	24ASPT ALTITUDE MP BEARING 6809 45X58X7
4	6 BEARING	1807042	PUS098	ENDURO BEARING 6900 2RS MAX TYPE, 22X10X6 SIZE
53	1 SLEEVE	1804035	PTW047	TOP LINK UPPER SLEEVE, OD:14, ID: 10.2, L:22
		1814025	ZCA013	2024 ALTITUDE MAIN PIVOT BEARING ONLY KIT
3	2 BEARING	1804045	PUS098	24ASPT ALTITUDE MP BEARING 6809 45X58X7
		1814026	PTW047	2024 ALTITUDE SHOCK BOLT KIT
6	1 BOLT	1804033	PTW047	FORWARD SHOCK BOLT, M10x1.0, L:72
9	1 BOLT	1804040	PTW047	LOWER LINK SHOCK BOLT, M8x1.0, L:51
		1814058	PTW047	2024 ALTITUDE SHOCK BOLT KIT SM
6	1 BOLT	1804033	PTW047	FORWARD SHOCK BOLT, M10x1.0, L:72
13	1 BOLT	1805169		LOWER 27.5 LINK SHOCK BOLT, M8x1.0, L:51, 11 MM THREAD
		1814027	ZCA013	2024 ALTITUDE SHOCK BEARING EYELET KIT
2	2 BEARING	1801010	PUS098	ENDURO 688 LLU MAX 16X8X5
56	1 SLEEVE	1807028	PTW047	BEARING EYELET CENTRE SLEEVE
14	2 BRG CUP	1800031	PTW047	BEARING EYELET FOR 16X8X5 BRG
58	2 SPACER	1804042	PTW047	LOWER LINK SHOCK SPACER, 8 MM THRU
		1814028	PTW047	2024 ALTITUDE FORWARD SHOCK REDUCER KIT
5	2 BEARING SPACER	1804049	PTW047	FORWARD SHOCK REDUCER 10 MM THRU
		1812007		AXLE KIT BOOST 12X1.0
1	1 AXLE, REAR	3222000	PTW047	REAR AXLE 12X1.0 L:173MM, HARD BLACK ANODIZE
64	1 WASHER	3227006	PTW047	WASHER, 12x19x0.5MM, 304 SS
		1813467	PTW047	NEW HEAD TUBE PANEL KIT (FROM 2023)
27	1 HT PORT COVER	1803012	PTW047	2023 SLAYER CARBON HT PORT COVER, RIGHT
28	1 HT PORT COVER	1803013	PTW047	2023 SLAYER CARBON HT PORT COVER, LEFT
46	2 SCREW, M4X10	1800024-BK	PTW047	C'SUNK SOCKET SCREW, M4x10MM, 10.9 STEEL, BLACK
		1814039	ZCA013	ALLOY FRAME HT CABLE PORT KIT
12	3 BOLT	1804060	PTW047	M4x0.7 10MM HEX BUTTON HEAD
35	2 PORT COVER	1093011	P0072	ALLOY CABLE PORT COVER DOUBLE HOLE
36	1 PORT COVER	1093012	P0072	ALLOY CABLE PORT COVER BLANK
37	1 PORT COVER	1093013	P0072	ALLOY CABLE PORT COVER SINGLE 4mm HOLE
38	2 PORT COVER	1093014	P0072	ALLOY CABLE PORT COVER SINGLE 5mm HOLE
		1814040	ZCA013	ALLOY FRAME CS CABLE PORT KIT
12	1 BOLT	1804060	PTW047	M4x0.7 10MM HEX BUTTON HEAD
38	1 PORT COVER	1093014	P0072	ALLOY CABLE PORT COVER SINGLE 5mm HOLE
		1814029	PTW047	RIDE 4 THREADED 10MM CHIP KIT
20	1 FLIP CHIP	1804032	PTW047	RIDE 4 CHIP - THREADED, M10x1.0, T:10
21	1 FLIP CHIP	1804034	PTW047	RIDE 4 CHIP - 10 mm THRU
		1814031	PTW047	2024 ALTITUDE LOWER LINK FLIP CHIP
22	1 FLIP CHIP	1804041	PTW047	LOWER LINK FLIP CHIP 29 AND MX
23	1 FLIP CHIP	1804043	PTW047	LOWER LINK CHIP THREAD, M8x1.0, 29 OR MX
		1814032	ZCA013	2024 ALTITUDE ALLOY PROTECTION KIT
39	1 PROTECTOR	3704055	PTW110	2024 ALTTIUDE CHAIN STAY UPPER PROTECTOR
40	1 PROTECTOR	3704056	PTW110	2024 ALTTIUDE SEAT STAY PROTECTOR
41	2 PROTECTOR	3704057	PTW110	2024 ALTTIUDE TAILGATE PROTECTOR
42	1 PROTECTOR	3704058	PTW110	2024 ALTTIUDE CHAIN STAY LOWER PROTECTOR
43	1 PROTECTOR	3704059	PTW110	2024 ALTTIUDE DOWN TUBE PROTECTOR

LISTE DER KLEINTEILE-SÄTZE

		1814062	ZCA013
39	1 PROTECTOR	3704055	PTW110
40	1 PROTECTOR	3704056	PTW110
41	2 PROTECTOR	3704057	PTW110
42	1 PROTECTOR	3704058	PTW110
44	1 PROTECTOR	3704108	PTW110
		1814033	ZCA013
32	1 MUD GUARD	1994026	P0072
49	4 SCREW	1804068	PTW047
33	1 MUD GUARD	1994027	P0072
48	2 SCREW	1804067	PTW047
		1814034	ZCA013
16	1 CHAINGUIDE	3391004	PTW021
17	1 CHAINGUIDE BASE	1394003	PTW047
18	1 CHAINGUIDE SLIDE	3391002	PTW047
47	1 SCREW	1804055	PTW047
		1814042	PTW047
19	1 COMPLETE COVER S-A	1994031	PTW047
		1814043	ZCA013
	2 M5 BARREL	1994049	P0072
	2 SCREW	1804074	PTW047
		1814044	ZCA013
60	1 SUBFRAME S-A	1814004	P0072
12	7 BOLT	1804060	PTW047
	1 WRAP	AC00340S1	P0064
	1 BAG	AC00330S1	P0064
		1814050	ZCA013
	1 HEAD SET CUP	1194002	PUS105
		1814051	ZCA013
	1 HEAD SET CUP	1194004	PUS105
		1814052	ZCA013
	1 HEADSET	1194001	PUS105
		1814053	ZCA013
	1 HEADSET	1194003	PUS105

2024 ALTIITUDE CARBON PROTECTION KIT

2024 ALTIITUDE CHAIN STAY UPPER PROTECTOR
 2024 ALTIITUDE SEAT STAY PROTECTOR
 2024 ALTIITUDE TAILGATE PROTECTOR
 2024 ALTIITUDE CHAIN STAY LOWER PROTECTOR
 MY24 ALTIITUDE CARBON DOWN TUBE PROTECTOR

2024 ALTIITUDE MUD GUARD KIT

2024 ALTIITUDE REAR TRIANGLE MUD GUARD
 M4x0.7 DOME HEAD SCREW, L:7, HEX 2.5
 2024 ALTIITUDE SHOCK MUD GUARD
 M4x0.7 DOME HEAD SCREW, L:12, HEX 2.5

2024 ALTIITUDE CHAIN GUIDE

ONEUP CHAINGUIDE ASSEMBLY (1C0686)
 BASEPLATE FOR CHAINGUIDE
 SLIDING PART OF CHAINGUIDE
 C'SUNK SOCKET SCREW, M5X0.8, L:12 MM, 3MM HEX, SS

PENALTYBOX 2 COVER KIT

PENALTYBOX 2 COMPLETE COVER SUB-ASSEMBLY

PENALTYBOX 2 WB MOUNT INSERT KIT

BOTTLE CAGE M5 BARREL
 LOW PROFILE WATER BOTTLE SCREW M5x15

PENALTYBOX 2 FRAME MOUNT KIT

PENALTYBOX 2 MOUNTING FRAME
 M4x0.7 10MM HEX BUTTON HEAD

RMB TOOL WRAP 23 OS BK**RMB TUBE BAG 23 OS BK****5M OFFSET HEAD SET CUPS KIT CR BIKES**

FSA 5MM OFFSET OVAL CUPS W/ORING CR BIKES

5M OFFSET HEAD SET CUPS KIT AL BIKES

FSA 5MM OFFSET CUPS AL BIKES

OVAL OFFSET HEADSET KIT CR BIKES

FSA NO.85 1.5" 0MM OFFSET OVAL CUPS STAINLESS

OFFSET HEADSET KIT AL BIKES

FSA ZS56|66 0MM OFFSET HS STAINLESS STEEL

GARANTIE

Für dein Fahrrad besteht eine Garantie für Schäden durch Material- und Verarbeitungsfehler gemäß folgender Tabelle:

KATEGORIE	LAUFZEIT	HINWEISE
Rahmenteile	5 Jahre	Vorderes Rahmendreieck + hinteres Rahmendreieck, Gelenke
Hardware	1 Jahr	Gelenke, Achsen etc.
Verschleißteile des Antriebs	1 Jahr	Kettenräder, Ritzel, Antriebskette
Akku	2 Jahre	Bei Lagerung von über 3 Monaten den Akku alle 3 Monate laden. Nichtbeachtung kann Schäden verursachen.
Komponenten	Gemäß Garantie des Originalherstellers	

Garantiefälle und Kundenservice müssen von dem autorisierten Rocky Mountain Händler durchgeführt werden, der das komplette Fahrrad oder den Rahmen verkauft hat. Wir decken Ihren Rocky Mountain-Rahmen ab dem ursprünglichen Kaufdatum Ihres neuen Fahrrads gegen Material- und Verarbeitungsfehler ab, je nach Rahmenmaterial und der Art der Nutzung des Fahrrads.

Die beschränkte Garantie von Rocky Mountain deckt auch Fahrräder, die zuvor für private und kommerzielle Aktivitäten wie Verleih (einschließlich Fahrradparks), Kurierdienst, Polizeidienst, Sicherheitsdienst usw. verwendet wurden, gegen Material- und Verarbeitungsfehler ab. Die beschränkte Garantie gilt für den Rest der Garantiezeit ab dem ursprünglichen Kaufdatum bei Rocky Mountain. In solchen Fällen sind Hardware, Lager, Drehzapfen und Buchsen von unserer Garantie ausgeschlossen. Der Original-Kaufbeleg, die Bestätigung der Fahrradregistrierung oder ein anderer Kaufnachweis ist für alle Ansprüche erforderlich.

Bei Fahrrädern ab dem Modelljahr 2021 ist die ursprüngliche beschränkte Garantie auf den Zweitbesitzer übertragbar. Die beschränkte Garantie gilt nur dann, wenn sowohl der Erst- als auch der Zweitbesitzer das Fahrrad online registriert haben. Die Originalrechnung ist für den Zweitbesitzer nicht erforderlich.

Bitte registrieren Sie das Fahrrad zur Übertragung der Garantie.

Rahmenmaterial/Art der Nutzung

- Carbonfaser: 5 Jahre – Beschränkt*
- Aluminium: 5 Jahre – Beschränkt*
- Bitte beachten Sie die unten aufgeführten Beschränkungen

Weitere Garantie für Schäden durch Material- und Verarbeitungsfehler

- Beschichtung – Lackierung und Aufkleber: 1 Jahr
- Rahmenhardware, Federung, Gelenke und Buchsen: 1 Jahr
- * Gelenke sind Teil des Rahmens.

bikes.com/registration

GARANTIEINFORMATIONEN

HINWEIS

Garantie gilt nicht für Folgendes:

- Einbau und Verwendung von Komponenten, Teilen oder Zubehör, das ursprünglich nicht für das Fahrrad (oder den Rahmen) wie verkauft vorgesehen war oder nicht damit kompatibel ist
- Rocky Mountain Fahrrad wurde nicht von einem autorisierten Händler gekauft
- Rocky Mountain Fahrrad/Rahmen wurde im Internet durch Drittanbieter (z. B. eBay) erworben, unabhängig von den Angaben in der Auflistung
- Ausbleichen der Lackierung aufgrund von ultraviolettem Licht (UV) oder Außenbewitterung fallen nicht unter diese beschränkte Garantie.
- Rocky Mountain übernimmt keine Garantie für Schäden am Fahrrad, die beim Anbringen oder Entfernen von Schutzfilmprodukten entstehen.
- Kratzer oder Steinschläge durch Schmutz, Steine, Fremdkörper, Transport auf Träger etc. fallen nicht unter diese beschränkte Garantie.
- Schäden am Pressfit-Tretlager durch unsachgemäßen Service, Materialien oder Teile sind von der beschränkten Rocky Mountain Garantie nicht abgedeckt.

Einzelheiten dazu, was nicht von der Garantie abgedeckt ist:

- a. Normale Abnutzung und Verschleiß an Reifen, Schläuchen, Bremsen, Schaltzügen, Bremsbelägen, Lagern etc. sind nicht abgedeckt. Ihr autorisierter Rocky Mountain Händler kann genaue Informationen über die Wartung dieser Teile geben.
- b. Schäden, die durch unsachgemäße Nutzung, Unfall, Fehlgebrauch oder Vorsatz entstanden sind
- c. Unsachgemäße Montage oder unterlassene ordnungsgemäße Wartung, Sandstrahlen, Schleifen, Fräsen, Bürsten, Feilen, Schweißen, Lötten, das Bohren von Löchern, Eloxieren, Neulackieren oder Verchromen werden von unserer Garantie nicht abgedeckt und können dazu führen, dass die Garantie der anderen Komponenten erlischt.
- d. Neben dem hohen Risiko für Leib und Leben, kann die Herstellergarantie, wie in der Garantie-Tabelle aufgelistet, erlöschen, wenn unsere Produkte in extremem Gelände verwendet werden, wie es zum Teil in Mountainbike Videos gezeigt wird (wie zum Beispiel das Befahren extremer Trails, über Rampen springen, Stunts, BMX Trails befahren, in der Stadt über Treppen und andere Hindernisse fahren oder in ähnlichem Gelände fahren). Es sei darauf hingewiesen, dass verbogene Komponenten wie Rahmenteile, Gabeln, Lenker, Sattelstützen, Pedale, Speichen, etc. als Zeichen von Unfällen oder unsachgemäßer Nutzung angesehen werden können.
- e. Arbeitskosten für den Austausch oder den Wechsel von Teilen sind nicht eingeschlossen.
- f. Rocky Mountain Bicycles behält sich vor, Teile und Komponenten nach eigenem Ermessen als Garantiefall einzustufen und entsprechend zu reparieren oder zu ersetzen. Bitte beachten Sie, dass Rocky Mountain alle Anstrengungen unternimmt, jedoch eine Farbübereinstimmung mit dem ursprünglichen Teil nicht garantieren kann.

GARANTIEAUSSCHLUSS UND HAFTUNGSBESCHRÄNKUNGEN

DIE GARANTIE VON ROCKY MOUNTAIN IST AUF DIE REPARATUR BZW. DEN AUSTAUSCH DER PRODUKTE BESCHRÄNKT UND SCHLIESST KEINE GARANTIE, WEDER AUSDRÜCKLICH NOCH IMPLIZIT, GESETZLICH ODER KONVENTIONELL EIN, UND SCHLIESST JEDLICHE IMPLIZITE GEWÄHRLEISTUNG DER MARKTFÄHIGKEIT UND DER EIGNUNG FÜR BESTIMMTE ZWECKE AUS. ROCKY MOUNTAIN HAFTET UNTER KEINEN UMSTÄNDEN FÜR DIREKTE ODER INDIREKTE, BESTIMMTE, ZUFÄLLIGE ODER FOLGESCHÄDEN, SELBST WENN ROCKY MOUNTAIN ÜBER DIESE SCHÄDEN UNTERRICHTET WURDE. DIE HAFTUNGSSUMME VON ROCKY MOUNTAIN IST AUF 50,00 DOLLAR BESCHRÄNKT.

INTRODUZIONE

Goditi tutta la sicurezza che ti può dare la Altitude. Dalle gare a cronometro alle corse con gli amici nel fine settimana, questa bici è realizzata appositamente per andare veloce, aggredire i sentieri più ripidi e aiutarti a dominare i terreni più tecnici. Le sue caratteristiche da enduro complete possono aiutarti non solo a conquistare il podio, ma anche ad affrontare le avventure più impegnative e coinvolgenti del weekend. Tutte queste capacità a tua disposizione ti mettono voglia di superare i limiti, salire più veloce e migliorare.

Questo manuale contiene importanti informazioni sulla sicurezza, la manutenzione e l'uso. Leggilo attentamente e comprendilo a fondo prima di usare la tua nuova bicicletta Rocky Mountain per la prima volta. Questo materiale si applica solo alla piattaforma specifica che hai scelto e deve essere utilizzato insieme al tuo Manuale del proprietario di Rocky Mountain, incluso con la tua bicicletta. Leggi il Manuale del proprietario prima di utilizzare la tua bicicletta per la prima volta. Se non hai una copia del Manuale del proprietario, puoi richiederla al più vicino rivenditore autorizzato Rocky Mountain.

SHREDIQUETTE

Ciclisti

Mostra sempre educazione verso chi si trova sugli stessi sentieri. Presta particolare attenzione agli animali domestici, come i cani e i cavalli. Concedi agli altri utenti del sentiero il diritto di passaggio in tutte le situazioni, sia in salita che in discesa.

Sentieri

Usa la tua bicicletta solo su sentieri o percorsi destinati alle biciclette. Osserva tutte le leggi e i regolamenti vigenti a livello locale. Come per tutti gli utenti dei sentieri, anche i ciclisti devono prestare attenzione a non danneggiare i sentieri o l'ambiente naturale. Non sbandare sui sentieri e non modificarli.



R: J.Leroux P: Margus Riga L: BC



CONOSCERE LA TUA BICICLETTA



DETTAGLI TECNICI

- La nuovissima Altitude è caratterizzata da una riprogettazione completa con il peso ridistribuito più in basso, un telaio più rigido, regolazioni aggiuntive per una migliore adattabilità al ciclista e diverse nuove caratteristiche tecniche che elevano ulteriormente questo design rispetto alle generazioni precedenti.
- La cinematica LC2R è stata rivista per garantire sensibilità abbinata a un maggiore supporto lungo tutta l'escursione, con l'obiettivo di ridurre l'affaticamento del ciclista nelle lunghe e impegnative prove delle gare di enduro.
- Il telaio SM è dotato di ruote anteriori e posteriori da 27,5 pollici, mentre i telai MD-LG-XL sono dotati di ruote anteriori e posteriori da 29 pollici. I telai MD-LG-XL possono essere configurati con ruote MX (29 anteriori / 27,5 posteriori), se lo si desidera, senza necessità di aggiungere parti al telaio.
- Il sistema di regolazione RIDE-4™ permette ai ciclisti di mettere a punto rapidamente la geometria con una sola chiave a brugola.
- Tutti i telai sono dotati di serie sterzo con regolazione precisa del reach. Sul telaio è installata una serie sterzo neutra da 0 mm. Nella scatola delle minuterie in dotazione con ogni telaio e bicicletta completa c'è un set aggiuntivo di coppe della serie sterzo da 5 mm che possono essere utilizzate per regolare il reach.
- Il nostro nuovo vano portaoggetti Penalty Box 2.0 è resistente all'acqua ed è dotato di una doppia chiusura rigida, facile da usare. C'è anche uno scomparto segreto dove puoi aggiungere un dispositivo di localizzazione, come Tile o AirTag, per proteggere meglio la tua bici.
- Tutti i telai sono dotati di supporti per accessori sotto il tubo orizzontale per riporre ulteriori oggetti. Nei telai LG e XL è possibile inserire in questa posizione una seconda bottiglia d'acqua da 600 ml.
- I cuscinetti sigillati sull'occhiello dell'ammortizzatore ne migliorano notevolmente la sensibilità (compatibile con gli ammortizzatori post-vendita), mentre i cuscinetti schermati su tutto il telaio aiutano a prevenire la contaminazione su sentieri dissestati o nelle stazioni di lavaggio post-corsa.

CONOSCERE LA TUA BICICLETTA



DETTAGLI TECNICI

- La nostra sospensione LC2R è caratterizzata da un perno principale del movimento centrale concentrico con un design rigido dei link abbinato a cuscinetti durevoli e sovradimensionati.
- Tutti i modelli includono un guida catena OneUp integrato, con linguette ISCG05 a 2 bulloni per il montaggio di un paracolpi, che mantiene la catena in posizione e la corona intatta.
- I telai sono dotati di ampie protezioni in gomma per ridurre il rumore e prevenire l'abrasione da contatto.
- Tutti i telai sono compatibili almeno con le borracce LG (600 ml, 21 oz).

GEOMETRIA E DIMENSIONI

Il modello Altitude ha un design del telaio specifico per ogni dimensione, con dettagli curati per una geometria su misura per ogni ciclista.

Taille des roues

- Il telaio SM è equipaggiato con ruote da 27,5 pollici davanti e dietro.
- I telai MD, LG e XL sono equipaggiati con ruote da 29 pollici davanti e dietro e sono anche compatibili con MX (mullet).
- La regolazione MX si effettua cambiando la posizione del chip di montaggio dell'ammortizzatore del link inferiore.

Chip in posizione 29 Chip in posizione 27,5 (MX)



Interasse posteriore (detto anche lunghezza del foderò orizzontale)

- La versione del carro posteriore è specifica per le dimensioni del telaio. I telai LG e XL usano la stessa versione. Consulta la tabella delle geometrie per maggiori dettagli. I carri posteriori dei telai MD, LG e XL sono intercambiabili, se si vuole sperimentare una diversa lunghezza dell'interasse posteriore sui telai di queste dimensioni.

Serie sterzo con regolazione del reach

- Tutti i telai sono dotati di serie sterzo con regolazione precisa del reach. Sul telaio è installata una serie sterzo neutra da 0 mm. Nella scatola delle minuterie in dotazione con ogni telaio e bicicletta completa c'è un set aggiuntivo di coppe della serie sterzo da 5 mm che possono essere utilizzate per regolare il reach. Quando consulti la tabella delle geometrie con le coppe per offset da 5 mm installate, ti basta aggiungere o sottrarre 5 mm dalle misure reach, lunghezza tubo orizzontale e interasse, in base all'orientamento delle coppe. Per le istruzioni sull'installazione, consulta la sezione sulle caratteristiche del telaio.

Serie sterzo in carbonio 0 mm Serie sterzo in carbonio 5 mm



Serie sterzo in lega 0 mm

Serie sterzo in lega 5 mm



GEOMETRIA E DIMENSIONI

Ride-4

Il sistema di regolazione RIDE-4™ permette ai ciclisti di mettere a punto rapidamente la geometria con una sola chiave a brugola da 6 mm. Esistono quattro configurazioni possibili grazie a una coppia di chip rotanti. Consulta la tabella delle geometrie per vedere come ogni posizione influisce sulla geometria. Per le istruzioni sulla regolazione, consulta la sezione sulle caratteristiche del telaio.

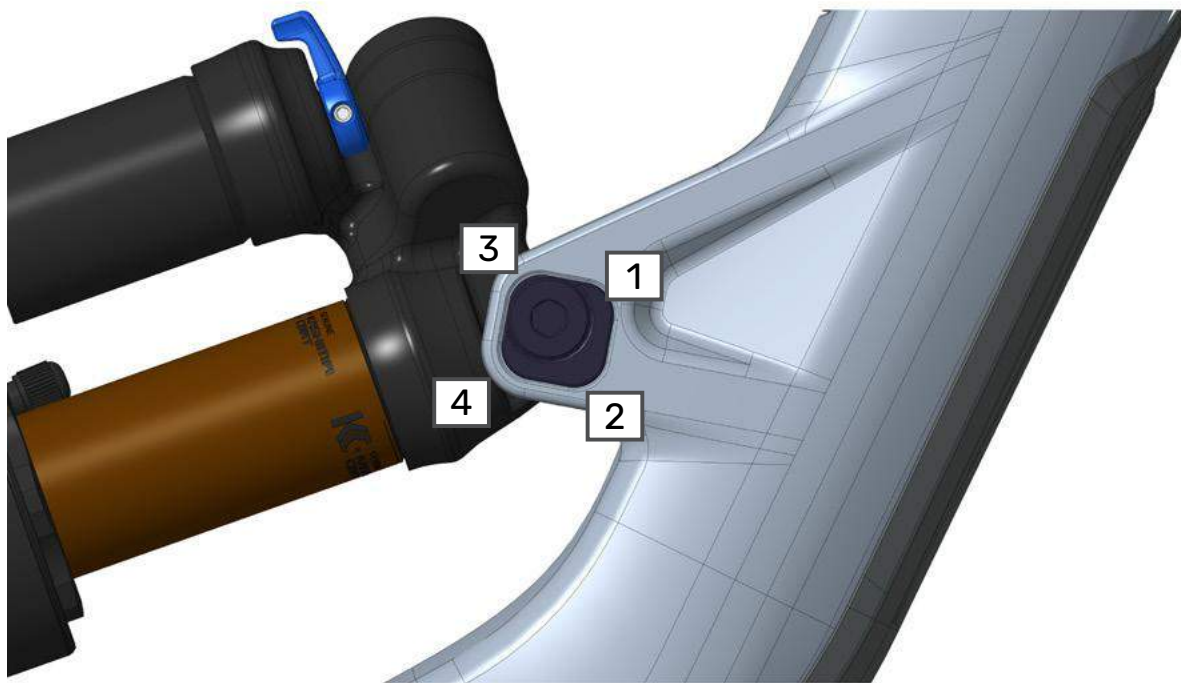

GEOMETRIA E DIMENSIONI

Dimensioni del telaio

Questa tabella è solo una guida indicativa. Le proporzioni del ciclista, lo stile di guida e le preferenze personali sono tutti fattori che incidono sulla scelta della misura corretta della bicicletta. In generale, le bici con un reach più corto tendono a restituire una sensazione più dinamica e vivace. La sensazione data dalle bici più lunghe tende a essere più stabile e morbida. Rocky Mountain consiglia di effettuare sempre un giro di prova e una configurazione professionale della bicicletta presso un rivenditore autorizzato.

CM	152.5	155	157.5	160	162.5	165	167.5	170	172.5	175	177.5	180	183	185.5	188	190.5	193	195.5	198
FT-IN	5'0"	5'1"	5'2"	5'3"	5'4"	5'5"	5'6"	5'7"	5'8"	5'9"	5'10"	5'11"	6'	6'1"	6'2"	6'3"	6'4"	6'5"	6'6"
	SM				MD				LG				XL						
SM																			
MD																			
LG																			
XL																			

CM	152.5	155	157.5	160	162.5	165	167.5	170	172.5	175	177.5	180	183	185.5	188	190.5	193	195.5	198
FT-IN	5'0"	5'1"	5'2"	5'3"	5'4"	5'5"	5'6"	5'7"	5'8"	5'9"	5'10"	5'11"	6'	6'1"	6'2"	6'3"	6'4"	6'5"	6'6"
	SM				MD				LG				XL						
SM																			
MD																			
LG																			

Tabella delle geometrie

MISURA TELAIO Dimensioni ruote	SM 27.5	MD	LG 29	XL	MD	LG MX	XL
Angolo canotto di sterzo (gradi)	63	63	63	63	62,9	62,9	62,9
Angolo tubo piantone (gradi)	77	77	77	77	77	77	77
Lunghezza tubo piantone (mm)	365	410	440	470	410	440	470
Lunghezza tubo orizzontale (mm)	553	584	610	642	584	610	642
Lunghezza canotto di sterzo (mm)	100	105	115	130	105	115	130
Interasse posteriore (mm)	Posizione 1 Ampia		430	440	450	450	450
Drop movimento centrale (mm)	24	38	38	38	29	29	29
Altezza standover (mm)	760	792	798	809	791	797	808
Interasse (mm)	1189	1244	1283	1319	1243	1282	1319
Reach (mm)	424	450	475	505	450	475	505
Stack (mm)	599	630	639	653	630	639	653

GEOMETRIA E DIMENSIONI

MISURA TELAIO Dimensioni ruote		SM 27.5	MD	LG 29	XL	MD	LG MX	XL
Angolo canotto di sterzo (gradi)		63,3	63,3	63,3	63,3	63,2	63,2	63,2
Angolo tubo piantone (gradi)		77,3	77,3	77,3	77,3	77,2	77,2	77,2
Lunghezza tubo piantone (mm)		365	410	440	470	410	440	470
Lunghezza tubo orizzontale (mm)		553	584	610	642	584	610	642
Lunghezza canotto di sterzo (mm)		100	105	115	130	105	115	130
Interasse posteriore (mm)	Posizione 2	430	440	450	450	440	450	450
Drop movimento centrale (mm)		20	34	34	34	25	25	25
Altezza standover (mm)		763	794	801	812	793	801	812
Interasse (mm)		1189	1243	1283	1319	1242	1282	1318
Reach (mm)		427	453	478	508	453	478	508
Stack (mm)		599	630	639	653	630	639	653
Angolo canotto di sterzo (gradi)		63,5	63,5	63,5	63,5	63,4	63,4	63,4
Angolo tubo piantone (gradi)		77,5	77,5	77,5	77,5	77,4	77,4	77,4
Lunghezza tubo piantone (mm)		365	410	440	470	410	440	470
Lunghezza tubo orizzontale (mm)		553	584	610	642	584	610	642
Lunghezza canotto di sterzo (mm)		100	105	115	130	105	115	130
Interasse posteriore (mm)	Posizione3 Neutral	430	440	450	450	440	450	450
Drop movimento centrale (mm)		17	31	31	31	22	22	22
Altezza standover (mm)		765	796	803	814	796	803	814
Interasse (mm)		1188	1243	1282	1319	1242	1281	1318
Reach (mm)		430	455	480	510	455	480	510
Stack (mm)		599	630	639	653	630	639	653
Angolo canotto di sterzo (gradi)		63,8	63,8	63,8	63,8	63,7	63,7	63,7
Angolo tubo piantone (gradi)		77,8	77,8	77,8	77,8	77,7	77,7	77,7
Lunghezza tubo piantone (mm)		365	410	440	470	410	440	470
Lunghezza tubo orizzontale (mm)		553	584	610	642	584	610	642
Lunghezza canotto di sterzo (mm)		100	105	115	130	105	115	130
Interasse posteriore (mm)	Posizione 4 Steep	430	440	450	450	440	450	450
Drop movimento centrale (mm)		13	27	27	27	18	18	18
Altezza standover (mm)		768	798	806	817	798	806	817
Interasse (mm)		1188	1242	1282	1319	1241	1281	1317
Reach (mm)		433	458	483	513	458	483	513
Stack (mm)		599	630	640	653	630	639	653

GEOMETRIA E DIMENSIONI

Montaggio del reggisella telescopico

I reggisella telescopici svolgono un ruolo importante per l'adattamento e il comfort della bicicletta. Di seguito troverai le dimensioni e le misure fondamentali che ti guideranno nella configurazione del reggisella OEM, oltre ad alcune delle possibili opzioni in caso di installazione di un reggisella telescopico post-vendita. La tabella mostra il montaggio del reggisella con l'escursione completamente estesa, consentendoti di determinare la posizione più bassa o più alta in cui il reggisella può essere regolato per ottenere l'altezza corretta in una posizione di pedalata da seduti. La tabella ti aiuta anche a determinare la misura del reggisella da installare se quello OEM non è della misura desiderata. La dimensione indicata è misurata dal centro del movimento centrale alla parte superiore della sella OEM. La lunghezza del set pedivelle può influenzare l'adattamento della seduta e deve essere presa in considerazione se si cambia questo componente.

Come usare la tabella

1. Misura l'attuale altezza della sella dal centro del movimento centrale alla parte superiore della sella, proprio sopra il reggisella.
2. Scegli il modello del reggisella, l'escursione/drop e il telaio.
3. Assicurati che la tua misura sia compresa tra la lunghezza di inserimento minima e massima indicate nella tabella.

Esempio: la mia misura sulla mia bici attuale è di 795 mm. Se scelgo un modello OneUp V3, con escursione di 210 mm, su un telaio LG in carbonio, vedo che questa combinazione di escursione del reggisella e misura del telaio è adatta a me, dato che le misure minime e massime possibili sono 735 mm e 860 mm.

MODELLO REGGISELLA	ESCURSIONE REGGISELLA	MISURA TELAIO	CARBON				ALLOY			
			SM	MD	LG	XL	SM	MD	LG	XL
X Fusion Manic		Lunghezza tubo piantone	365	410	440	470	365	410	440	470
		Altezza minima sella	100	100	100	100	100	100	100	100
		Inserimento massimo	212	260	290	320	192	240	270	300
	150	Altezza minima sella	661	658	685	715	681	678	685	715
	150	Altezza massima sella	735	780	810	840	735	780	810	840
	170	Altezza minima sella	705	702	705	735	725	722	722	735
	170	Altezza massima sella	749	794	824	854	749	794	824	854
	200	Altezza minima sella	770	767	767	767	790	787	787	787
	200	Altezza massima sella	794	839	869	899	794	839	869	899
	200	Altezza minima sella	732	737	737	766	772	747	777	807
	200	Altezza minima sella	794	839	869	899	794	839	869	899
2020- 2024	150	Altezza minima sella	644	643	673	703	664	661	673	703
	150	Altezza massima sella	728	773	803	833	728	773	803	833
	175	Altezza minima sella	701	698	698	728	721	718	718	728
	175	Altezza massima sella	785	830	860	890	785	830	860	890
Race Face Turbine R	200	Altezza minima sella	757	754	754	754	777	774	774	774
	Fox Transfer	200	Altezza massima sella	791	836	866	896	791	836	866
	200	Altezza minima sella	719	724	724	754	759	734	764	794
	200	Altezza minima sella	791	836	866	896	791	836	866	896

GEOMETRIA E DIMENSIONI

MODELLO REGGISSELLA	ESCURSIONE REGGISSELLA	MISURA TELAIO	CARBON				ALLOY			
			SM	MD	LG	XL	SM	MD	LG	XL
Reverb AXS *l'inserimento minimo del reggisella è 80 mm, tuttavia il telaio richiede 100 mm	150	Altezza minima sella	661	670	700	730	681	678	700	730
	150	Altezza massima sella	750	795	825	855	750	795	825	855
	170	Altezza minima sella	701	698	720	750	721	718	720	750
	170	Altezza massima sella	790	835	865	895	790	835	865	895
OneUp V2 Dropper *L'escursione è regolabile e può essere ridotta fino a 20 mm, con incrementi di 10 mm	150	Altezza minima sella	618	638	668	698	638	638	668	698
	150	Altezza massima sella	725	770	800	830	725	770	800	830
	180	Altezza minima sella	678	675	698	728	698	695	698	728
	180	Altezza massima sella	755	800	830	860	755	800	830	860
	210	Altezza minima sella	738	735	735	758	758	755	755	758
	210	Altezza massima sella	785	830	860	890	785	830	860	890
	240	Altezza minima sella	808	805	805	805	828	825	825	825
	240	Altezza massima sella	815	860	890	920	815	860	890	920
BikeYoke Divine 3 *L'escursione è regolabile e può essere ridotta fino a 30 mm, a seconda delle opzioni di escursione, con incrementi di 5 mm.	160	Altezza minima sella	649	652	682	712	669	666	682	712
	160	Altezza massima sella	740	785	815	845	740	785	815	845
	185	Altezza minima sella	699	696	707	737	719	716	716	737
	185	Altezza massima sella	790	835	865	895	790	835	865	895
	213	Altezza minima sella	764	761	761	765	784	781	781	781
	213	Altezza massima sella	825	870	900	930	825	870	900	930

SPECIFICHE E DIMENSIONI

Caratteristiche del telaio

Perno principale del movimento centrale concentrico

La nuova Altitude è dotata di un perno principale del movimento centrale concentrico che richiede un attrezzo speciale per il montaggio e lo smontaggio. Questo attrezzo (articolo 59, codice seriale 1804039) viene fornito con tutti i telai e le biciclette complete nella scatola delle minuterie per consentire al proprietario di eseguire da solo la manutenzione o, nel caso in cui si rivolga a qualcun altro per la manutenzione del telaio, di fornire l'attrezzo al centro di assistenza. L'attrezzo è contrassegnato con il valore di coppia (25 Nm) da usare per un montaggio corretto.

Diagramma esploso del link inferiore della Altitude

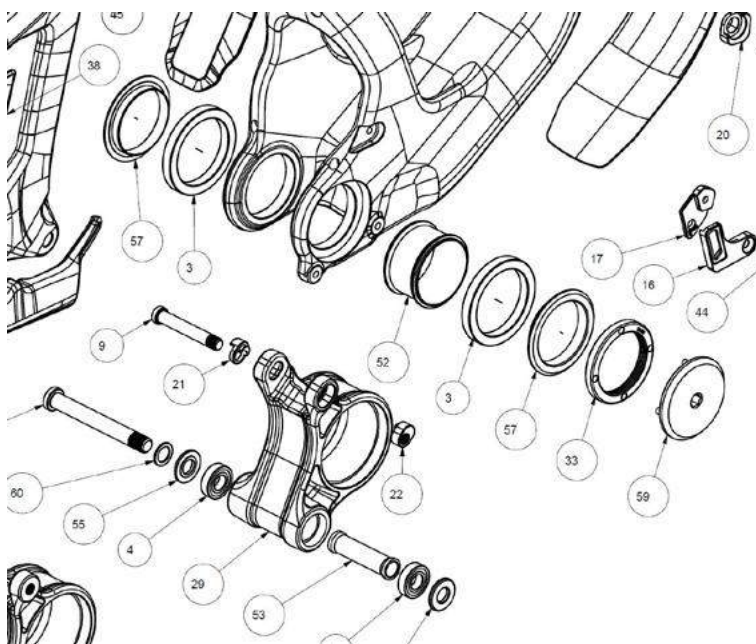

Il perno principale è sagomato in modo da incastrarsi nel telaio e non ruotare durante il montaggio. È accettabile un limitato gioco rotazionale tra l'interfaccia sagomata dell'asse del perno principale e il telaio. Il perno sarà fissato in modo stabile dopo che il dado di bloccaggio sarà avvitato a fondo.

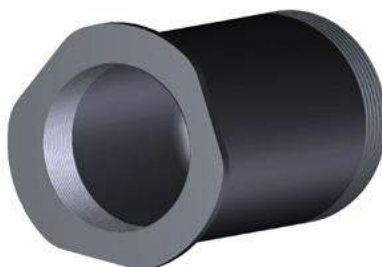

SPÉCIFICATIONS ET DIMENSIONS

Serie sterzo con regolazione del reach

Tutti i telai sono dotati di serie sterzo con regolazione precisa del reach. Sul telaio è installata una serie sterzo neutra da 0 mm. Nella scatola delle minuterie in dotazione con ogni telaio e bicicletta completa c'è un set aggiuntivo di coppe della serie sterzo da 5 mm che possono essere utilizzate per regolare il reach.

Il telaio Altitude in carbonio utilizza coppe della serie sterzo ovali di tipo drop-in. Non sono necessari attrezzi per rimuovere e installare le coppe nel telaio. Le coppe sono allineate automaticamente grazie alla forma ovale combaciante delle coppe e del canotto di sterzo. Le coppe sono dotate di un anello integrato al loro esterno che le mantiene fissate al telaio e riduce i movimenti potenzialmente rumorosi. Il modello delle serie sterzo dei telai in carbonio è il n. 85-1, prodotto da FSA. Utilizza parti di assemblaggio standard di FSA, come i cuscinetti e i race, per garantire che la sostituzione delle parti soggette a usura avvenga senza problemi.

Il telaio Altitude in lega utilizza coppe della serie sterzo sovradimensionate da inserire con pressione. Per rimuovere e installare le coppe nel telaio sono necessari attrezzi specializzati per l'installazione della serie sterzo. L'allineamento non è guidato dalla forma delle coppe e del canotto di sterzo e pertanto deve essere gestito con attenzione per essere portato a termine correttamente. Le coppe presentano un segno sul lato esterno per l'allineamento al telaio. Il modo più semplice per assicurarsi che l'allineamento delle coppe sia corretto è allineare un righello dal bordo dritto lungo questo segno e la lunghezza del tubo orizzontale (coppa superiore) o del tubo obliquo (coppa inferiore). Il modello delle serie sterzo dei telai in lega è HS-RM-01, prodotto da FSA. Utilizza parti di assemblaggio standard di FSA, come i cuscinetti e i race, per garantire che la sostituzione delle parti soggette a usura avvenga senza problemi.

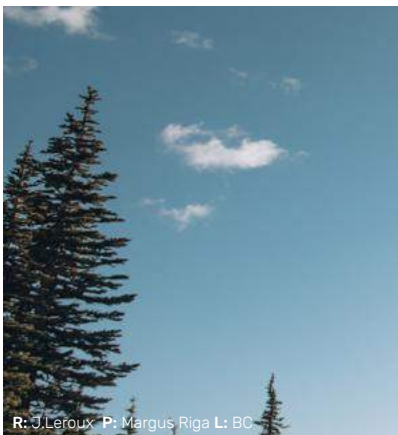

SPECIFICHE E DIMENSIONI

Elementi serie sterzo Altitude in carbonio

NUMERO ELEMENTO	QTÀ	ELEMENTO	CODICE SERIALE	DESCRIZIONE
N/A	N/A	Serie sterzo	H0504H0000EK01	Serie sterzo FSA n. 85-1 offset 0 mm, completa
N/A	N/A	Set coppe serie sterzo	H4204G00ZZE900	FSA n. 85-1 offset 5 mm, solo coppe
1	1	Anello in gomma	MS053 (872)	Anello interno in gomma del tappo superiore
2	1	Tappo superiore	H2051A	Tappo superiore FSA 5,3 mm
3	1	Guarnizione in gomma	MS073	Guarnizione esterna in gomma del tappo superiore
4	1	Race diviso	H2036 (No.5-2)	Anello di compressione FSA per serie sterzo da 1 1/8"
5	1	Cuscinetto	MR054S	Cuscinetto FSA in acciaio inossidabile ACB 1 1/8" 36°x45°
6	1	Coppa superiore	H4205A	Coppa superiore FSA offset 0 mm
7	1	Coppa superiore	H4204	Coppa superiore FSA offset 5 mm
8	1	Anello in gomma	MS399	Anello coppa superiore
9	1	Anello in gomma	MS406	Anello coppa inferiore
10	1	Coppa inferiore	H5145A	Coppa inferiore FSA offset 0 mm
11	1	Coppa inferiore	H5144	Coppa inferiore FSA offset 5 mm
12	1	Cuscinetto	MR110S	Cuscinetto FSA in acciaio inossidabile ACB 1,5" 36°x45°
13	1	Crown race	H6083 (No.42 ACB-6)	Crown race FSA 1,5"

Elementi serie sterzo Altitude in lega

NUMERO ELEMENTO	QTÀ	ELEMENTO	CODICE SERIALE	DESCRIZIONE
N/A	N/A	Serie sterzo	H066500000E101	Serie sterzo FSA RMB ZS56 66 offset 0 mm, completa
N/A	N/A	Set coppe serie sterzo	H4214A00ZZE100	FSA RMB ZS56 66 offset 5 mm, solo coppe
1	1	Anello in gomma	MS053 (872)	Anello interno in gomma del tappo superiore
2	1	Tappo superiore	H2051A	Tappo superiore FSA 5,3 mm
3	1	Guarnizione in gomma	MS073	Guarnizione esterna in gomma del tappo superiore
4	1	Race diviso	H2036 (No.5-2)	Anello di compressione FSA per serie sterzo da 1 1/8"
5	1	Cuscinetto	MR054S	Cuscinetto FSA in acciaio inossidabile ACB 1 1/8" 36°x45°
6	1	Coppa superiore	H4217	Coppa superiore FSA ZS56 offset 0 mm
7	1	Coppa superiore	H4214	Coppa superiore FSA ZS56 offset 5 mm
8	1	Coppa inferiore	H5149	Coppa inferiore FSA ZS66 offset 0 mm
9	1	Coppa inferiore	H5148	Coppa inferiore FSA ZS66 offset 5 mm
10	1	Cuscinetto	MR110S	Cuscinetto FSA in acciaio inossidabile ACB 1,5" 36°x45°
11	1	Crown race	H6083 (No.42 ACB-6)	Crown race FSA 1,5"

GEOMETRIA E DIMENSIONI

Ride-4

Il sistema di regolazione RIDE-4™ permette ai ciclisti di mettere a punto rapidamente la geometria con una sola chiave a brugola da 5 mm. Esistono quattro configurazioni possibili grazie a una coppia di chip rotanti. Consulta la tabella delle geometrie per vedere come ogni posizione influisce sulla geometria. Per le istruzioni sulla regolazione, consulta la sezione sulle caratteristiche del telaio.

PRONTI PER OGNI SENTIERO

Il sistema di regolazione RIDE-4™ permette al biker di regolare in modo preciso la geometria e le sospensioni con una chiave a brugola da 5 mm.

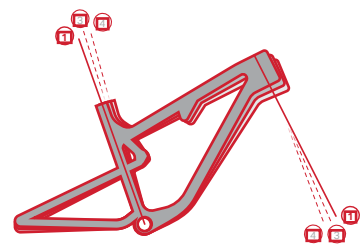

Posizione 1



Il movimento centrale più basso e la sospensione progressiva aumentano la stabilità alle alte velocità. Raccomandata per ciclismo più aggressivo

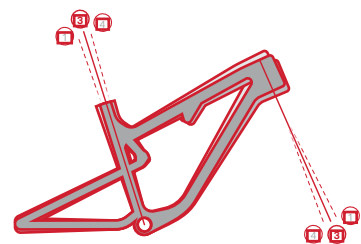

Posizione 3



Questa posizione offre un mix equilibrato di geometria e prestazioni delle sospensioni per adattarsi a una grande varietà di percorsi

Posizione 4



Il movimento centrale più alto e la sospensione lineare consentono una migliore distanza dai pedali, un tasso di sospensione iniziale più sostenuto e una posizione sulla bicicletta più adatta alla salita.

PENALTY BOX 2.0

Il telaio 2024 Altitude (solo carbonio) è dotato del nuovissimo vano portaoggetti Penalty Box 2.0, con fodero portattrezzi e borsa per la camera d'aria. Il coperchio è dotato del nostro innovativo sistema a doppia chiusura che lo mantiene saldo evitando i rumori. Per aprire il coperchio è sufficiente tirare la leva esterna. Non è necessario rimuovere l'eventuale borraccia inserita, ma è possibile farlo per accedere meglio al vano. Si prega di notare che mentre la maggior parte dei portaborraccia si adattano alla copertura Penalty Box 2.0, ce n'è un piccolo numero che non lo farà senza alcune modifiche. Si consiglia di testare il montaggio della gabbia e di assicurarsi che il dispositivo di chiusura abbia un range di movimento completo per rilasciare il coperchio. In alcuni casi, le rondelle installate sotto la gabbia, insieme ai bulloni più lunghi necessari, creeranno spazio sufficiente per il funzionamento della chiusura.



Il coperchio presenta un vano speciale per installare un dispositivo di localizzazione Tile o Airtag. Per accedere al vano, rimuovi i bulloni della borraccia e i dadi all'interno del coperchio. Quindi rimuovi il bullone esagonale da 2,5 montato sulla stessa parte del coperchio che fissa il vano del dispositivo di localizzazione. Potrai quindi accedere al vano. Segui le istruzioni di smontaggio al contrario per rimontare il coperchio.



SUGGERIMENTI SUL FODERO PORTATTREZZI (SOLO CARBONIO)

Per facilitare l'inserimento e la rimozione, assicurati che la camera d'aria sia completamente sgonfia e ben avvolta nell'apposito fodero. Assicurati che la fascetta sia rivolta verso l'apertura, in modo da poter rimuovere facilmente il fodero se dovesse scendere verso il movimento centrale o salire verso il canotto di sterzo.

Evita di mettere troppi oggetti nel fodero, per facilitarne l'inserimento e la rimozione. Il fodero portattrezzi è progettato per trasportare un piccolo attrezzo multiuso, una piccola pompa o un sistema di gonfiaggio a CO2 e vari altri piccoli oggetti come chiavi, denaro e kit riparazione gomme.

SPECIFICHE E DIMENSIONI

Configuration MX (« Mullet »)

Il telaio SM è dotato di ruote anteriori e posteriori da 27,5 pollici, mentre i telai MD-LG-XL sono dotati di ruote anteriori e posteriori da 29 pollici. I telai MD-LG-XL possono essere configurati con ruote MX (29 anteriori / 27,5 posteriori), se lo si desidera, senza necessità di aggiungere parti al telaio. La regolazione MX si effettua cambiando la posizione del chip di montaggio dell'ammortizzatore del link inferiore. Con una chiave esagonale da 5 mm, rimuovi il bullone dell'ammortizzatore posteriore dal lato opposto a quello di trasmissione e posiziona i chip su ciascun lato nella posizione corretta per la configurazione MX. Se torni alla configurazione da 29 pollici, installa i chip nella posizione 29. Per le posizioni corrette, si rinvia agli schemi seguenti.

Chip in posizione 27,5 (MX)



Chip in posizione 29



FORCELLINO UDH

Il tuo nuovo telaio è compatibile con il forcellino Sram UDH. Non sono necessarie altre parti per il montaggio e l'asse OEM è compatibile con il forcellino SRAM UDH.

1.



2.



OCCHIELLO E MINUTERIA CUSCINETTI AMMORTIZZATORE

Il telaio è dotato di cuscinetti a cartuccia nell'occhiello posteriore, che consentono una migliore aderenza ai piccoli urti. Questi cuscinetti sono portati da coppe saldamente installate sull'asse dell'ammortizzatore. Quando si fa la manutenzione dell'ammortizzatore, consigliamo vivamente di rimuovere questi componenti, poiché i centri di assistenza per le sospensioni non possono garantire che vengano restituiti. La minuteria dell'ammortizzatore anteriore è una combinazione di riduttori Rocky Mountain (parte n. 5) e di minuteria fornita dal produttore dell'ammortizzatore. Per informazioni tecniche su tutta la minuteria dell'ammortizzatore, diagrammi di riferimento e istruzioni per la rimozione del sistema di occhielli dei cuscinetti, consulta la tabella sottostante.

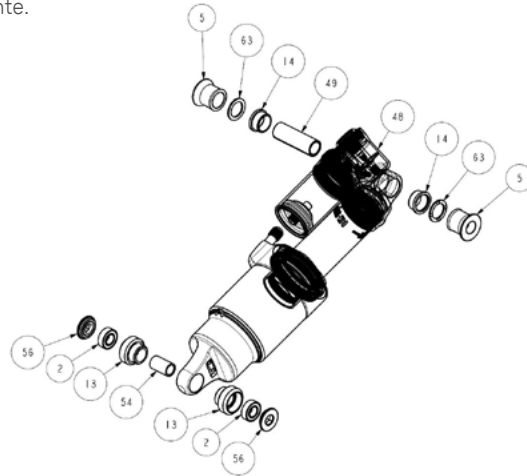

Occhiello dei cuscinetti dell'ammortizzatore posteriore Altitude - 35 x 8 mm (larghezza x diametro minuteria)

NUMERO ELEMENTO	QTÀ	ELEMENTO	CODICE SERIALE	DESCRIZIONE
N/A	1	Kit completo RMB	TBD	Kit occhiello cuscinetti ammortizzatori 8 x 35 mm
2	2	Cuscinetto	1801010	ENDURO 688 LLU MAX 16X8X5
13	2	Coppa cuscinetti	1800031	OCCHIELLO PER CUSCINETTI 16X8X5
54	1	Manicotto	1807028	MANICOTTO CENTRALE OCCHIELLO CUSCINETTI
56	2	Distanziale	1804042	DISTANZIALE AMMORTIZZATORE LINK INFERIORE, 8 MM PASSANTE

Minuteria dell'ammortizzatore anteriore Altitude - 40 x 10 mm (larghezza perno ammortizzatore x diametro minuteria)

NUMERO ELEMENTO	QTÀ	ELEMENTO	CODICE SERIALE	DESCRIZIONE
5	2	Distanziale	1804049	RIDUTTORE AMMORTIZZATORE ANTERIORE 10 MM PASSANTE
14	2	Boccola Fox	213-01-263	BOCCOLA FOX IGUS
	2	Boccola Rock Shox	11.4115.013.000	BOCCOLA ROCK SHOX IN TEFLON
49	1	Perno ammortizzatore	N/A	PERNO AMMORTIZZATORE (vedi informazioni sul kit completo qui sotto)
63	2	Rondella ammortizzatore	N/A	Rondella di compressione (vedi informazioni sul kit completo qui sotto)
N/A	1	Kit completo Fox	803-03-329	*Minuteria di montaggio FOX - 9 pezzi SS 10 mm x 40/1,575
N/A	1	Kit completo Rock Shox	N/A	*Non utilizzare i distanziali di plastica grandi inclusi nel kit"
N/A	1	Kit completo Rock Shox	11.4118.091.005	GRUPPO 3 PEZZI 1/2 POLL. MINUTERIA WD 3,65 DISTANZ. 40,0 X 10
N/A	1	Kit completo Rock Shox	11.4118.091.012	MINUTERIA ROCK SHOX 10 x 20,0 *Scartare il perno

Suggerimento: il kit completo Fox è compatibile con gli occhielli degli ammortizzatori Rock Shox. Rimuovi la boccola in teflon dall'occhiello Rock Shox prima di installare il kit Fox.

OCCHIELLO E MINUTERIA CUSCINETTI AMMORTIZZATORE

e dell'occhiello dei cuscinetti

Per rimuovere il sistema, segui questi passaggi:

- Utilizza il kit di attrezzi per occhielli ammortizzatori Rocky Mountain (codice n. 1810031)
- Installa la calotta copri cuscinetti su un lato dell'occhiello dei cuscinetti
- Quindi, installa uno degli attrezzi per la rimozione della coppa sopra la coppa dei cuscinetti con la calotta copri cuscinetti installata.
- Avvita saldamente la vite M8 contro la calotta copri cuscinetti
- Installa l'altro attrezzo di rimozione della coppa sopra l'altra coppa dei cuscinetti
- Avvita la vite M8 a fondo, fino a quando non inizia a spingere sull'altro lato ed è a contatto con l'interno della calotta copri cuscinetti.
- Continua a inserire fino a quando una delle coppe non è completamente estratta.
- Quindi inserisci il punteruolo attraverso l'occhiello dell'ammortizzatore e appoggialo saldamente contro la coppa dei cuscinetti che è ancora premuta nell'occhiello dell'ammortizzatore.
- Delicatamente, ma con fermezza, martella il punteruolo fino a rimuovere completamente la coppa dei cuscinetti dall'occhiello dell'ammortizzatore.

Se non disponi del kit di attrezzi per l'occhiello dei cuscinetti Rocky Mountain, utilizza un estrattore per cuscinetti a foro cieco:

- Utilizza un estrattore per cuscinetti a foro cieco (estensione da 8 mm) per rimuovere entrambi i cuscinetti. Installa la calotta copri cuscinetti su un lato dell'occhiello dei cuscinetti.
- Rimuovi il manicotto centrale.
- Utilizza l'estrattore per cuscinetti a foro cieco (estensione da 10 mm) per rimuovere le coppe vuote.

NOTA: il diametro interno delle coppe è di 11 mm, il che significa che l'estensione da 12 mm non è adatta (quindi non forzarla); utilizza l'estensione da 10mm.

Per installare nuove coppe, utilizza una pressa per cuscinetti o una morsa con ganasce morbide installate, assicurandoti di premere sul bordo esterno delle coppe, e non dimenticare il manicotto distanziatore centrale tra le coppe.

CONFIGURAZIONE DELLE SOSPENSIONI

Prima di cambiare le impostazioni degli ammortizzatori, è importante informarsi sulle varie regolazioni possibili.

Regolazione della molla

A seconda del modello di ammortizzatore, può essere necessario regolare la capacità di assorbimento della molla elicoidale o la pressione dell'aria per ottenere il sag consigliato per Altitude. Consulta la tabella delle molle di seguito per le raccomandazioni sulla capacità di assorbimento delle molle elicoidali e sulla pressione dell'aria.

Rebond

La regolazione del ritorno controlla la velocità alla quale la sospensione ritorna a estensione completa dopo un urto. Se il controllo del ritorno è eccessivo, la forcella o l'ammortizzatore si sposteranno troppo lentamente, affondando sempre di più nella loro escursione a seguito di urti ripetuti, dando una sensazione di rigidità. Se il controllo del ritorno è insufficiente, la sospensione e la molla possono ritornare indietro troppo velocemente, causando una perdita di trazione e di controllo.

- LSR (Low Speed Rebound, ritorno a bassa velocità) si riferisce alla bassa velocità della forcella o dell'ammortizzatore, non alla velocità su sentiero. Questa regolazione influisce sulla velocità del ritorno nella prima parte dell'escursione. Per comodità, possiamo ipotizzare un'escursione compresa tra lo 0% e il 40%.
- HSR (High Speed Rebound, ritorno ad alta velocità) si riferisce all'alta velocità della forcella o dell'ammortizzatore, non alla velocità su sentiero. Questa regolazione influisce sulla velocità del ritorno nella seconda parte dell'escursione. Per comodità, possiamo ipotizzare un'escursione compresa tra il 40% e il 100%.

Compression

La regolazione della compressione controlla la velocità con cui le sospensioni si muovono nella loro escursione durante un impatto. Se il controllo della compressione è eccessivo, la forcella o l'ammortizzatore si muoveranno troppo lentamente e la forza dell'impatto si scaricherà eccessivamente sullo pneumatico e sul corpo del ciclista. Se il controllo della compressione è insufficiente, la forcella o l'ammortizzatore si muoveranno troppo rapidamente, restituendo una sensazione di lentezza e di scarsa reattività della bicicletta.

- LSC (Low Speed Compression, compressione a bassa velocità) si riferisce alla bassa velocità della forcella o dell'ammortizzatore, non alla velocità su sentiero. Controlla gli spostamenti di peso del ciclista, i movimenti di pompaggio, i cambiamenti improvvisi della forza di accelerazione e altre azioni lente. Troppa LSC si tradurrà in una sensazione di guida più dura; una LSC insufficiente si tradurrà in una sensazione di guida troppo morbida e che non risponde. La LSC è efficace per tutta l'escursione.
- HSC (High Speed Compression, compressione ad alta velocità) si riferisce all'alta velocità della forcella o dell'ammortizzatore, non alla velocità su sentiero. Controlla la capacità di assorbire impatti importanti, come le rocce a spigolo vivo e i fondocorsa. Troppa HSC causa una sensazione di guida più dura quando si percorrono sentieri veloci e accidentati con molte asperità; una HSC insufficiente non fornisce abbastanza supporto in caso di forti asperità e può portare all'utilizzo di tutta l'escursione delle sospensioni.

Fondocorsa idraulico

Il fondocorsa idraulico (Hydraulic Bottom Out, HBO) si riferisce alla resistenza alle grandi compressioni che alcuni ammortizzatori possono fornire in combinazione con un regolatore esterno. Questo influisce sull'ultimo 20% dell'escursione dell'ammortizzatore e viene utilizzato in caso di forti impatti in cui l'ammortizzatore può giungere al fondocorsa.

Consulta le tabelle seguenti per le configurazioni di tutti gli ammortizzatori OEM per il modello Altitude. Dato l'elevato numero di ammortizzatori compatibili con Altitude, non possiamo fornire guide all'installazione per modelli che non rientrano nelle specifiche OEM.

CONFIGURATION DE LA SUSPENSION

Quando regoli la sospensione, annota le impostazioni in modo da poterle rivedere in futuro. Meglio ancora, usa un foglio di calcolo online sul tuo telefono!

La rimozione dell'ammortizzatore della Altitude, con il suo design delle sospensioni LC2R, può richiedere ulteriori passaggi. Ecco una guida passo-passo sulla rimozione. Per l'installazione è sufficiente seguire le istruzioni al contrario. Assicurati di rispettare i valori di coppia indicati nell'elenco delle minuterie incluso nel PDF del diagramma esploso.

1. Passa al pignone piccolo dei rapporti e blocca la gabbia del deragliatore in posizione aperta, se possibile.
2. Rimuovi la ruota.
3. Assicurati che le aree del telaio tra il tubo piantone e il link siano pulite e prive di detriti.
4. Rimuovi il bullone dell'ammortizzatore anteriore.
 - Ricordati di sostenere il carro posteriore una volta rimossa la bulloneria dell'ammortizzatore anteriore e di estenderlo delicatamente all'indietro fino a quando il ponte del fodero verticale non entra in contatto con il tubo piantone.
5. Rimuovi il bullone dell'ammortizzatore posteriore.
 - Se necessario, puoi rimuovere i chip Ride4 su entrambi i lati del link.
6. Rimuovi l'ammortizzatore
 - I distanziali degli occhielli dei cuscinetti su ciascun lato cadranno, quindi assicurati di mettere una mano sotto l'area degli occhielli dei cuscinetti per afferrarli.

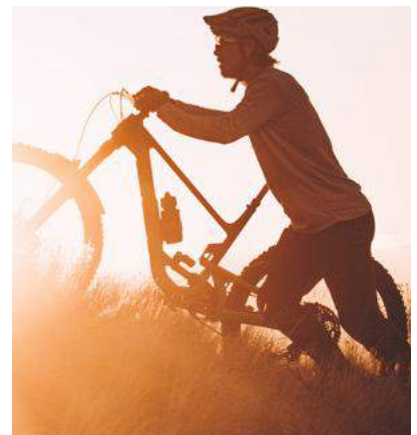

CONFIGURAZIONE DELLE SOSPENSIONI

2024 ALTITUDE AMMORTIZZATORE A MOLLA FOX DHX2

DIMENSIONI AMMORTIZZATORE SM = 210 X 55 MM MD - XL = 230 X 60 MM
 REGOLAZIONE AMMORTIZZATORE CX001, JCR010, REZI BX001
 NOTE *CONTEGGIO CLIC DA CHIUSO: 0 CLIC = CHIUSO*

PESO DEL CICLISTA	MOLLA IN ACCIAIO	SAG DELL'AMMORTIZZATORE	LSR	HSR	LSC	HSC	COMPRESSION RAPIDE
100lbs 45kg	300	275		10-11	6-7	14-15	6-7
110lbs 50kg	300	300		9--11	6-7	14-15	6-7
120lbs 55kg	350	325		8-9	6-7	14-15	6-7
130lbs 59kg	350	350		8-10	6-7	13-14	6-7
140lbs 64kg	400 (SM)	375		6-7	5-6	12-13	5-6
150lbs 68kg	400	400		6-7	5-7	11-13	5-6
160lbs 73kg	450 (MD)	425	SM 16 - 19mm	5-6	4-5	9-10	5-6
170lbs 77kg	450	450		5-6	4-5	9-11	4-6
180lbs 82kg	500 (LG)	475	MD - XL 19 - 21mm	4-5	4-5	9-10	4-5
190lbs 86kg	500	500		4-5	3-5	7-9	3-4
200lbs 91kg	550 (XL)	525		3-4	3-4	6-7	3-4
210lbs 95kg	600	550		2-3	2-3	5-6	2-3
220lbs 100kg	600			2-3	2-3	5-6	2-3
230lbs 105kg	650			1-2	1-2	4-5	1-2
240lbs 109kg	700	Non disponibile		1-2	0-1	3-4	0-1
250lbs 114kg	700			1-2	0-1	3-4	0-1

2024 ALTITUDE AMMORTIZZATORE A MOLLA FOX DHX

DIMENSIONI AMMORTIZZATORE SM = 210 X 55MM MD - XL = 230 X 60MM
 REGOLAZIONE AMMORTIZZATORE CMSSB027, RF, REZI BVMLHB03LM
 NOTE *CONTEGGIO CLIC DA CHIUSO: 0 CLIC = CHIUSO* 0 CLICKS = CLOSED*

PESO DEL CICLISTA	MOLLA IN ACCIAIO	SAG DELL'AMMORTIZZATORE	LSR	HSR	LSC	HSC	COMPRESSION RAPIDE
100lbs 45kg	300	275		10		9 - Open	
110lbs 50kg	300	300		10		9	
120lbs 55kg	350	325		10 - 9		8 - 9	
130lbs 59kg	350	350		9		8	
140lbs 64kg	400 (SM)	375		9 - 8		7 - 8	
150lbs 68kg	400	400		8		7	
160lbs 73kg	450 (MD)	425	SM 16 - 19mm	8 - 7		6 - 7	
170lbs 77kg	450	450		7		6	
180lbs 82kg	500 (LG)	475	MD - XL 19 - 21mm	7 - 6	Non disponibile	5 - 6	Non disponibile
190lbs 86kg	500	500		6		5	
200lbs 91kg	550 (XL)	525		6 - 5		4 - 5	
210lbs 95kg	600	550		5		4	
220lbs 100kg	600			5 - 4		3 - 4	
230lbs 105kg	650			4		3	
240lbs 109kg	700	Non disponibile		4 - 3		2 - 3	
250lbs 114kg	700			3		2	

CONFIGURAZIONE DELLE SOSPENSIONI

2024 ALTITUDE AMMORTIZZATORE PNEUMATICO FOX FLOAT X2

DIMENSIONI AMMORTIZZATORE SM = 210 X 55 MM MD - XL = 230 X 60 MM
 REGOLAZIONE AMMORTIZZATORE DISTANZIALE 0,3 X1, CX001, JCR010, REZI BX001
 NOTE *CONTEGGIO CLIC DA CHIUSO: 0 CLIC = CHIUSO*

PESO DEL CICLISTA	MOLLA IN ACCIAIO	SAG DELL'AMMORTIZZATORE	LSR	HSR	LSC	HSC
100lbs 45kg	120psi 8.3bar		11-13	5-6	14-16	6-7
110lbs 50kg	130psi 9bar		10-12	5-6	13-15	6-7
120lbs 55kg	140psi 9.7bar		9-11	4-5	13-15	6-7
130lbs 59kg	150psi 10.3bar		8-10	4-5	12-14	5-6
140lbs 64kg	160psi 11bar		7-9	4-5	11-13	5-6
150lbs 68kg	170psi 11.7bar		7-9	3-4	10-12	5-6
160lbs 73kg	180psi 12.4bar	SM	6-8	3-4	9-11	4-5
170lbs 77kg	190psi 13.1bar	16 - 19mm	6-8	3-4	8-10	4-5
180lbs 82kg	200psi 13.8bar	MD - XL	5-7	2-3	7-9	4-5
190lbs 86kg	210psi 14.5bar	19 - 21mm	4-6	2-3	6-8	4-5
200lbs 91kg	220psi 15.2bar		3-5	2-3	5-7	3-4
210lbs 95kg	230psi 15.9bar		2-4	2-3	4-6	3-4
220lbs 100kg	240psi 16.5bar		2-4	1-2	2-4	3-4
230lbs 105kg	250psi 17.2bar		1-3	1-2	2-4	3-4
240lbs 109kg	260psi 17.9bar		1-3	1-2	2-4	2-3
250lbs 114kg	270psi 18.6bar		1-2	1-2	1-3	1-2

2024 ALTITUDE AMMORTIZZATORE PNEUMATICO FOX FLOAT X

DIMENSIONI AMMORTIZZATORE SM = 210 X 55 MM MD - XL = 230 X 60 MM
 REGOLAZIONE AMMORTIZZATORE DISTANZIALE 0,4, CMSSB024, RM, REZI BVMLHB01LM
 NOTE *CONTEGGIO CLIC DA CHIUSO: 0 CLIC = CHIUSO*

PESO DEL CICLISTA	MOLLA IN ACCIAIO	SAG DELL'AMMORTIZZATORE	LSR	HSR	LSC	HSC
100lbs 45kg	120psi 8.3bar		10		9 - Open	
110lbs 50kg	130psi 9bar		10		9	
120lbs 55kg	140psi 9.7bar		10 - 9		8 - 9	
130lbs 59kg	150psi 10.3bar		9		8	
140lbs 64kg	160psi 11bar		9 - 8		7 - 8	
150lbs 68kg	170psi 11.7bar		8		7	
160lbs 73kg	180psi 12.4bar	SM	8 - 7		6 - 7	
170lbs 77kg	190psi 13.1bar	16 - 19mm	7		6	
180lbs 82kg	200psi 13.8bar	MD - XL	7 - 6	Non disponibile	5 - 6	Non disponibile
190lbs 86kg	210psi 14.5bar	19 - 21mm	6		5	
200lbs 91kg	220psi 15.2bar		6 - 5		4 - 5	
210lbs 95kg	230psi 15.9bar		5		4	
220lbs 100kg	240psi 16.5bar		5 - 4		3 - 4	
230lbs 105kg	250psi 17.2bar		4		3	
240lbs 109kg	260psi 17.9bar		4 - 3		2 - 3	
250lbs 114kg	270psi 18.6bar		3		2	

CONFIGURAZIONE DELLE SOSPENSIONI

2024 ALTITUDE AMMORTIZZATORE PNEUMATICO ROCK SHOX SUPER DELUXE

DIMENSIONI AMMORTIZZATORE SM = 210 X 55 MM MD - XL = 230 X 60 MM
 REGOLAZIONE AMMORTIZZATORE OL1 PRM 32SN
 NOTE *CONTEGGIO CLIC DA CHIUSO: 0 CLIC = CHIUSO*

PESO DEL CICLISTA	MOLLA IN ACCIAIO	SAG DELL'AMMORTIZZATORE	LSR	HSR	LSC	HSC
100lbs 45kg	110psi 7.6bar		11-12			
110lbs 50kg	120psi 8.3bar		10-11			
120lbs 55kg	130psi 9bar		9--11			
130lbs 59kg	140psi 9.7bar		8-9			
140lbs 64kg	150psi 10.3bar		8-10	Inizio a impostazione neutra (3a posizione) Regola 1 clic alla volta per ottenere la sensazione di fondocorsa desiderata. Il	Inizio a impostazione neutra (3a posizione) Regola 1 clic alla volta per ottenere il supporto desiderato nei movimenti dell'albero a bassa velocità, come il pompaggio dei dossi, il precarico per un salto o una caduta, o un maggiore supporto nelle salite.	Inizio a impostazione neutra (3a posizione) Regola 1 clic alla volta per ottenere il supporto desiderato nei movimenti dell'albero ad alta velocità, come l'impatto contro spigoli vivi, i terreni rocciosi e i grandi salti.
150lbs 68kg	160psi 11bar	SM	6-7	fondocorsa idraulico opzionale interviene per limitare il flusso dell'olio nell'ultimo 20% dell'escursione, offrendo un morbido cuscino idraulico che riduce l'impatto del fondocorsa.		
160lbs 73kg	170psi 11.7bar	16 - 19mm	6-7			
170lbs 77kg	180psi 12.4bar		5-6			
180lbs 82kg	190psi 13.1bar	MD - XL	5-6			
190lbs 86kg	200psi 13.8bar	19 - 21mm	4-5			
200lbs 91kg	210psi 14.5bar		4-5			
210lbs 95kg	220psi 15.2bar		3-4			
220lbs 100kg	230psi 15.9bar		2-3			
230lbs 105kg	240psi 16.5bar		2-3			
240lbs 109kg	250psi 17.2bar		1-2			
250lbs 114kg	260psi 17.9bar		1-2			

2024 ALTITUDE AMMORTIZZATORE A MOLLA ROCK SHOX SUPER DELUXE

DIMENSIONI AMMORTIZZATORE SM = 210 X 55 MM MD - XL = 230 X 60 MM
 REGOLAZIONE AMMORTIZZATORE PRM 32SN
 NOTE *CONTEGGIO CLIC DA CHIUSO: 0 CLIC = CHIUSO* LA CAPACITÀ DI ASSORBIMENTO DELLE MOLLE ELICOIDALI PER ROCK SHOX È 50# IN MENO RISPETTO A QUELLA PER FOX PER LA STESSA DIMENSIONE DI TELAIO. LA DIFFERENZA STA NEL DESIGN E NELLA MESSA A PUNTO SCELTA PER L'AMMORTIZZATORE POSTERIORE ROCK SHOX.

PESO DEL CICLISTA	MOLLA IN ACCIAIO	SAG DELL'AMMORTIZZATORE	LSR	HSR	LSC	HSC
100lbs 45kg	300		11-12			
110lbs 50kg	300		10-11			
120lbs 55kg	300		9--11			
130lbs 59kg	350		8-9			
140lbs 64kg	350 (SM)		8-10	Inizio a impostazione neutra (3a posizione) Regola 1 clic alla volta per ottenere la sensazione di fondocorsa desiderata. Il fondocorsa idraulico opzionale interviene per limitare il flusso dell'olio nell'ultimo 20% dell'escursione, offrendo un morbido cuscino idraulico che riduce l'impatto del fondocorsa.	Inizio a impostazione neutra (3a posizione) Regola 1 clic alla volta per ottenere il supporto desiderato nei movimenti dell'albero a bassa velocità, come il pompaggio dei dossi, il precarico per un salto o una caduta, o un maggiore supporto nelle salite.	Inizio a impostazione neutra (3a posizione) Regola 1 clic alla volta per ottenere il supporto desiderato nei movimenti dell'albero ad alta velocità, come l'impatto contro spigoli vivi, i terreni rocciosi e i grandi salti.
150lbs 68kg	400	SM	6-7			
160lbs 73kg	400(MD)	16 - 19mm	6-7			
170lbs 77kg	450		5-6			
180lbs 82kg	450 (LG)	MD - XL	5-6			
190lbs 86kg	500	19 - 21mm	4-5			
200lbs 91kg	500 (XL)		4-5			
210lbs 95kg	550		3-4			
220lbs 100kg	600		2-3			
230lbs 105kg	600		2-3			
240lbs 109kg	650		1-2			
250lbs 114kg	700		1-2			

ISTRUZIONI PER IL PASSAGGIO DEI CAVI

Queste istruzioni si applicano ai telai Altitude in carbonio e in lega. Ci sono lievi differenze nelle indicazioni per ogni modello di telaio, quindi presta molta attenzione alle istruzioni che si applicano al tuo telaio specifico.

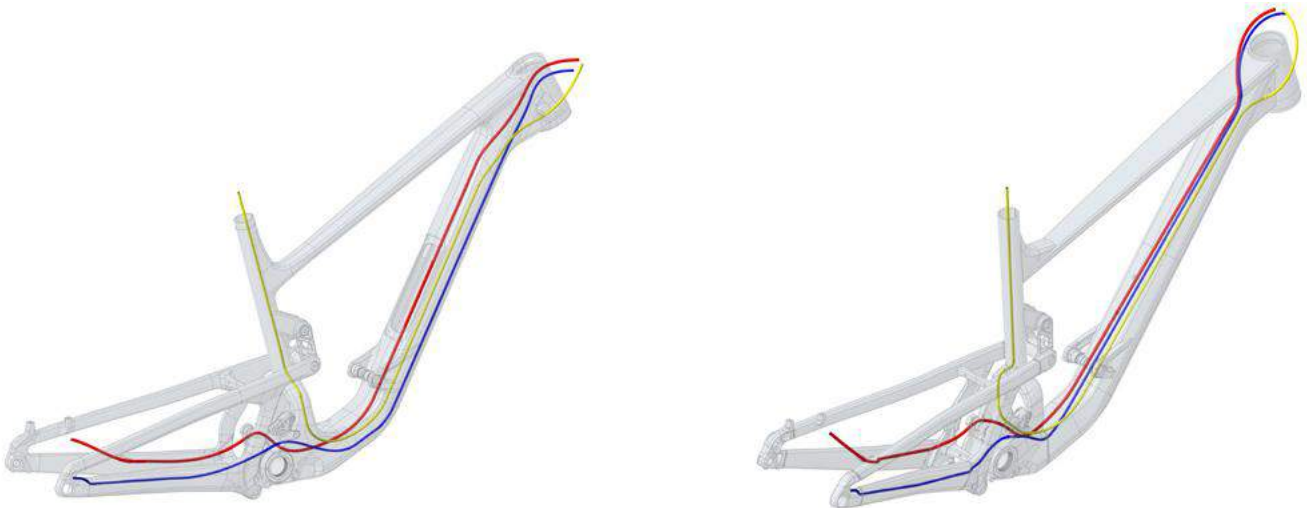

La rimozione della ruota e dell'ammortizzatore posteriori permette di ruotare il carro posteriore e consente un migliore accesso per inserire la guaina nell'area tra i carri posteriore e anteriore.

I canali per l'inserimento dei tubi nel foderò orizzontale possono a volte risultare stretti, specialmente considerando le curve che devono superare in alcuni casi. Spruzza acqua saponosa o alcol isopropilico nell'apertura come lubrificante per facilitare il passaggio della guaina da un'estremità all'altra. Non utilizzare grasso o olio; lascerà un pasticcio e attirerà lo sporco.

Il telaio in lega non ha guide interne per la guaina. Per guidare ed estrarre tutta la guaina dal telaio sono necessari attrezzi come il Park Tool IR-1.2 Internal Cable Routing Kit. Ti consigliamo di installare il cavo IR-1.2 al contrario, utilizzando la ghiera filettata collegata alla nuova guaina e tirando delicatamente la guaina verso la parte anteriore del telaio.

SOSTITUZIONE/INSTALLAZIONE DELLA GUAINA DEL CAVO DEL DERAGLIATORE POSTERIORE

Se sostituisci la vecchia guaina, rimuovila e taglia un nuovo pezzo della stessa lunghezza. Se non hai il pezzo vecchio, taglia una porzione leggermente più lunga della lunghezza richiesta.

1. Rimuovi il coperchio dell'apertura del canotto di sterzo dal

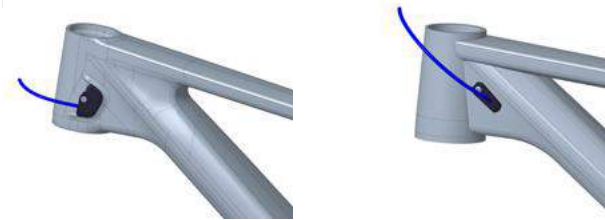

2. Cominciando dalla parte posteriore della bicicletta, inizia a inserire la guaina nell'apertura per il cavo sul fodero orizzontale lato trasmissione. Spingi la guaina in avanti ruotandola finché non fuoriesce dall'estremità anteriore del fodero orizzontale.



3. Guida la guaina nell'apposita apertura sopra il movimento centrale. Assicurati di inserire la guaina del deragliatore nell'apertura sul lato trasmissione.



4. Spingi il cavo dal retro finché non fuoriesce dall'apertura del canotto sterzo.

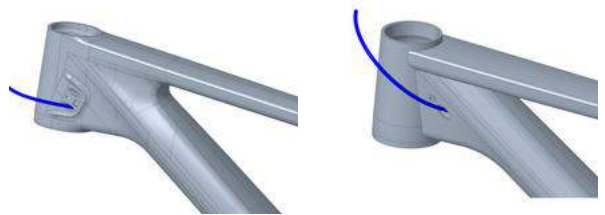

5. Una volta inserita completamente la guaina tra il selettore e il deragliatore posteriore, reinstalla l'apertura del canotto di sterzo. Per il telaio in lega, assicurati di installare la guaina in schiuma da 4 mm inclusa nel telaio. In caso di sostituzione della guaina in schiuma originale, quest'ultima potrebbe essere caduta all'interno del telaio e sarà necessario estrarla

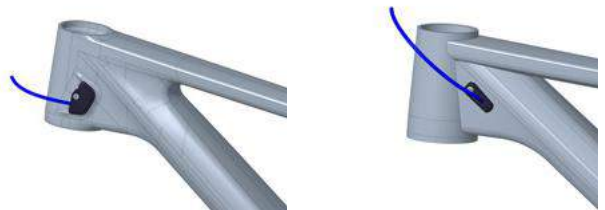

6. Per il telaio in lega, assicurati di fissare la guaina alla guida all'interno del tunnel dell'ammortizzatore, in modo da evitare che tocchi l'ammortizzatore.



SOSTITUZIONE/INSTALLAZIONE DELLA GUAINA DEL CAVO DEL REGGISSELLA TELESCOPICO

1. A seconda della posizione del tubo del freno posteriore, rimuovi il coperchio dell'apertura sul canotto di sterzo sul lato di trasmissione o su quello opposto.



2. Per il modello in carbonio: cominciando dall'apertura del canotto di sterzo, inizia a inserire la guaina nell'apertura inferiore. Spingi la guaina in avanti finché non fuoriesce dal tubo piantone.



3. Per il modello in lega: inserisci la guaina nell'apertura sul tubo piantone e guidala nell'apertura sul tubo obliquo.



4. Per il modello in lega: guida la guaina fino a farla uscire dall'apertura del cavo sul canotto di sterzo. Non dimenticare di installare la guaina in schiuma da 4 mm inclusa nel telaio. In caso di sostituzione della guaina in schiuma originale, quest'ultima potrebbe essere caduta all'interno del telaio e sarà necessario estrarla con cautela.



5. Completa l'installazione del reggisella telescopico secondo le istruzioni del produttore.

6. Una volta installato correttamente il reggisella, reinstalla l'apertura del canotto di sterzo.

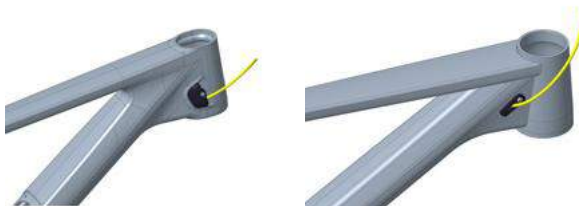

7. Per il telaio in lega, assicurati di fissare la guaina alla guida all'interno del tunnel dell'ammortizzatore, in modo da evitare che tocchi l'ammortizzatore.



SOSTITUZIONE/INSTALLAZIONE DEL TUBO FRENO IDRAULICO POSTERIORE

1. A seconda della posizione del tubo del freno posteriore, rimuovi il coperchio dell'apertura sul cannotto di sterzo sul lato di trasmissione o su quello opposto.

Passaggio cavi normale = lato opposto a quello di trasmissione

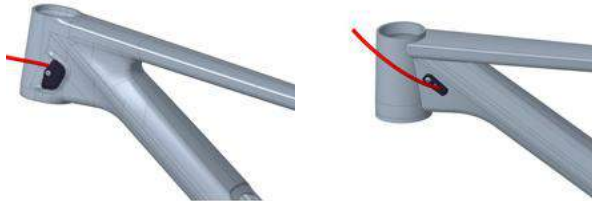

Passaggio cavi moto | UK-AUS = lato trasmissione

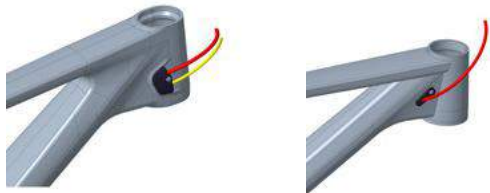

2. Per i telai in lega, rimuovi il coperchio all'interno del foderò orizzontale.



3. Iniziando dalla parte posteriore del telaio, spingi il tubo in avanti finché non fuoriesce dall'estremità anteriore del foderò orizzontale.

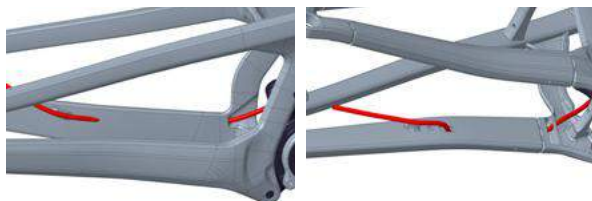

4. Guida il tubo del freno nell'apposita apertura sopra il movimento centrale. Assicurati di inserire il tubo del freno (rosso) nell'apertura sul lato opposto a quello di trasmissione.

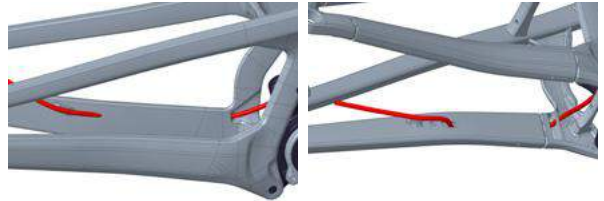

5. Per i telai in carbonio, rimuovi il coperchio del Penalty Box per accedere alle guaine interne. Nella parte del tubo della guaina interrotta, guida il tubo del freno nel canale desiderato. Il canale inferiore è per la posizione standard della leva del freno posteriore. Il tubo del freno uscirà dal lato del telaio opposto a quello di trasmissione e poi passerà sul lato destro fino alla leva. Il canale superiore è per la posizione della leva del freno posteriore moto | UK-AUS (lato sinistro).

Passaggio cavi normale = tubo inferiore



= tubo superiore

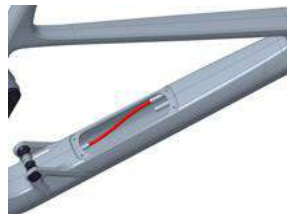

SOSTITUZIONE/INSTALLAZIONE DEL TUBO FRENO IDRAULICO POSTERIORE

6. Poi spingi il tubo del freno da dietro fino a farlo uscire dall'apertura del canotto di sterzo.

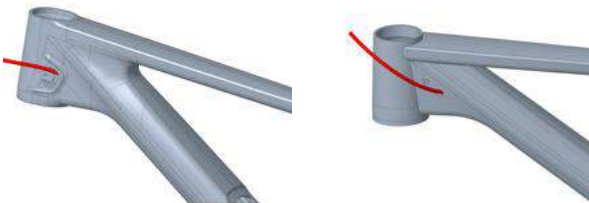

7. Per i telai in lega, guida la guaina fino a farla uscire dall'apertura del cavo sul canotto di sterzo. Non dimenticare di installare la guaina in schiuma da 5 mm inclusa nel telaio. In caso di sostituzione della guaina in schiuma originale, i tubi in schiuma potrebbero essere caduti all'interno del telaio e sarà necessario estrarli con cautela.

8. Una volta installato il tubo del freno, reinstalla il coperchio dell'apertura del canotto di sterzo.

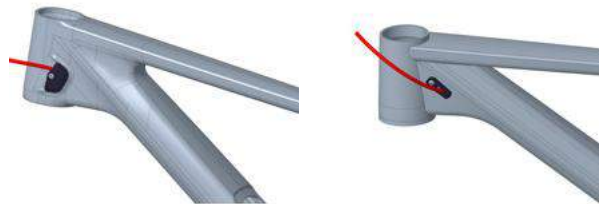

9. Per il telaio in lega, assicurati di fissare la guaina alla guida all'interno del tunnel dell'ammortizzatore, in modo da evitare che tocchi l'ammortizzatore.

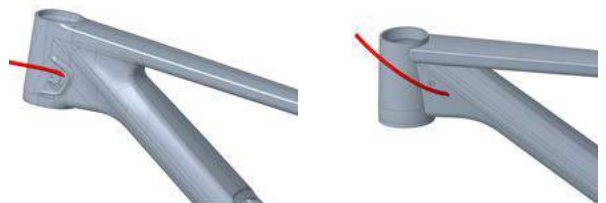

DIMENSIONI CRITICHE

NUMERO ELEMENTO	CATEGORIA	ELEMENTO	DIMENSIONE	CODICE SERIALE	DESCRIZIONE
1	Serie sterzo	Serie sterzo telaio in carbonio	FSA No.85-1 0mm Offset		Serie sterzo FSA n. 85-1 offset 0 mm, completa. Consulta la tabella delle serie sterzo per informazioni
		Set coppe serie sterzo telaio in carbonio	FSA No.85-1 5mm Offset		FSA n. 85-1 offset 5 mm, solo coppe. Consulta la tabella delle serie sterzo per informazioni
		Serie sterzo telaio in lega	FSA ZS56 66 0mm Offset		Serie sterzo FSA RMB ZS56 66 offset 0 mm, completa. Consulta la tabella delle serie sterzo per informazioni
		Set coppe serie sterzo telaio in lega	FSA ZS56 66 5mm Offset		FSA RMB ZS56 66 offset 5 mm, solo coppe. Consulta la tabella delle serie sterzo per informazioni
2	Forcella	Escursione della forcella	170mm		
		Offset forcella	SM = 37mm		
			MD - LG - XL = 42 - 44mm		
		Altezza massima da asse a testa	SM = 567mm MD - LG - XL = 586mm		
3	Ammortizzatore	Dimensione ammortizzatore	SM = 210 x 55mm MD - LG - XL = 230 x 60mm		I telai MD - LG - XL sono compatibili con 210 x 55 mm
		Regolazione ammortizzatore	Vedi descrizione		Per informazioni sulla regolazione, consulta la tabella di configurazione dell'ammortizzatore
		Minuteria dell'ammortizzatore anteriore	40 x 10mm		Richiede minuteria personalizzata. Consulta la tabella della minuteria dell'ammortizzatore per informazioni
		Minuteria dell'ammortizzatore posteriore	35 x 8mm	1811007	Richiede minuteria dell'occhiello cuscinetti personalizzata. Consulta la tabella della minuteria dell'ammortizzatore per informazioni
		Ammortizzatori approvati	Vedi descrizione		Tutti i modelli di ammortizzatori posteriori Fox Tutti i modelli di ammortizzatori posteriori Rock Shox
4	Reggisella	Diametro interno tubo piantone	30.9mm		Per le dimensioni del reggisella
		Diametro esterno tubo piantone	34.9mm		Per le dimensioni del fermo della sella
		Inserimento minimo tubo piantone	100mm		
		Profondità alesatura tubo piantone	SM = 202 192mm MD = 250 240mm		Per informazioni sul montaggio del reggisella, consulta la relativa sezione di questo manuale
		Carbonio Lega	LG = 280 270mm XL = 310 300mm		

DIMENSIONI CRITICHE

NUMERO ELEMENTO	CATEGORIA	ELEMENTO	DIMENSIONE	CODICE SERIALE	DESCRIZIONE
5	Set pedivelle	Intervallo dimensioni corona	Minimum = 30 Maximum = 34D		
		Dimensioni corona OEM Lunghezza catena	SM = 32 T 116 L		
		Kit guida catena	MD = 32 T 118 L		
			LG - XL = 32 T 120 L	TBD	Canadarm 2.0 specifico per Altitude + guida superiore OneUp compatibile
		Guida catena	Consulter la description	IC0686	Per le singole parti vedi il diagramma esploso
		Paracolpi	2-Bolt ISCG05		Schema di montaggio ISCG05 a 2 bulloni per il solo montaggio dei paracolpi
		Movimento centrale.	BSA 73mm		
	Intervallo linea catena	52 - 55mm			
6	Freno	Diamètre de disque maximal	220mm		
		Épaisseur de disque maximal	2.3mm		
7	Ruota		SM = 27.5"		
			MD - LG - XL = 29"		Compatibile MX (Mullet) tramite chip di ribaltamento
8	Mozzo posteriore	Larghezza massima pneumatico	2.5" 63mm		
		Distanza mozzo	12 x 148mm		
		Asse posteriore	12 x 1.0 x 173mm		Diametro 12 mm x passo filettatura 1,0 mm x lunghezza 173 mm
		Asse di ricambio	Vedi descrizione	3222000	Diametro 12 mm x passo filettatura 1,0 mm x lunghezza = 173 mm
		Kit forcellino completo	Vedi descrizione	1812002	Include forcellino, dado e rondella. Per le singole parti vedi il diagramma esploso
		UDH Trasmissione	Vedi descrizione		Il telaio è compatibile con UDH e trasmissione

VISTA ESPLOSA

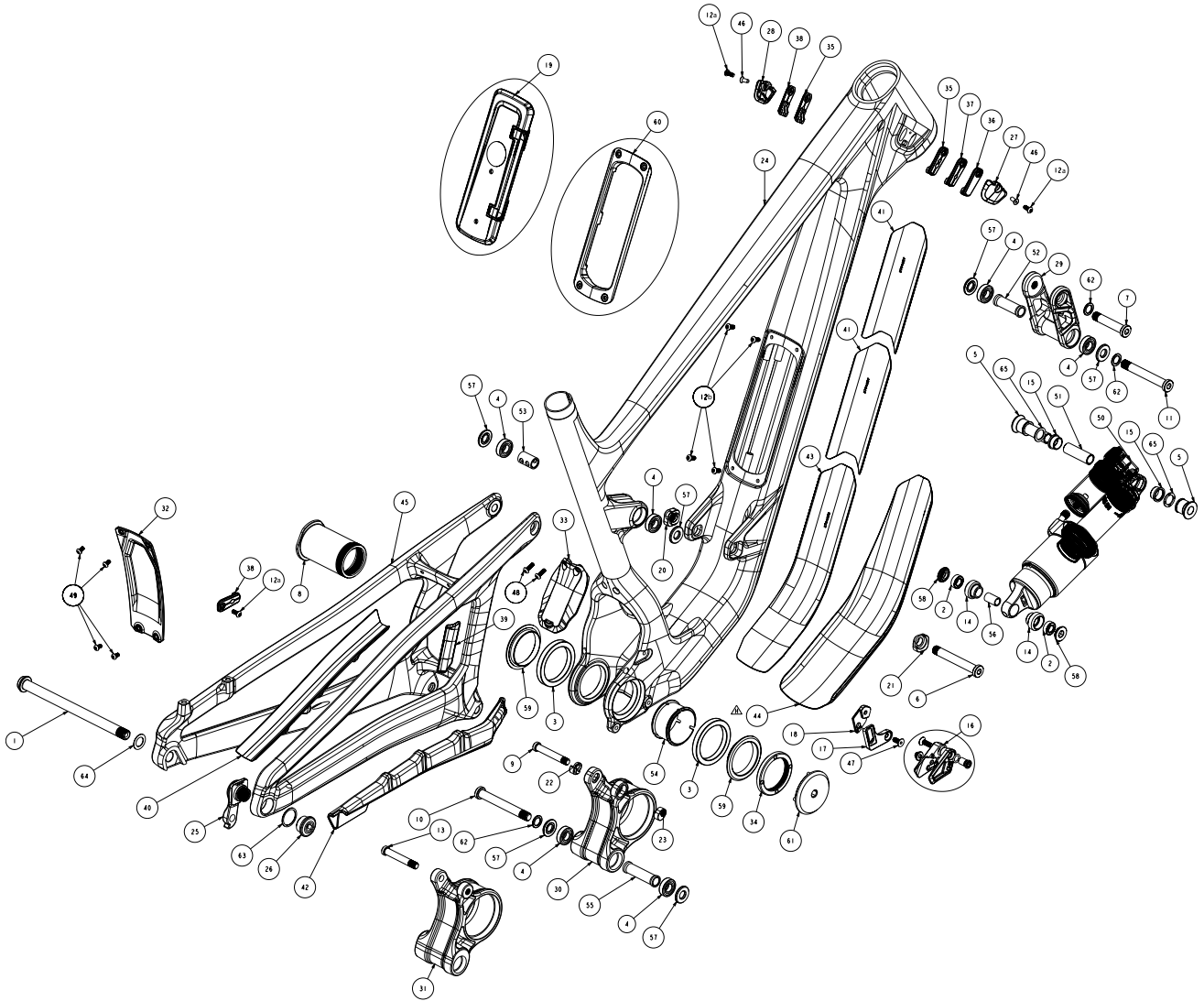

ELENCO PARTI E ISTRUZIONI DI MONTAGGIO

#	QTY	ITEM	PART NO.	TORQUE (Nm)	INSTALLATION NOTES	
					DESCRIPTION	INSTALLATION NOTES
1	1	AXLE, REAR	3222000	10	REAR AXLE 12X1.0 L:173MM, HARD BLACK ANODIZE	Apply grease to axle shaft and threads. Use
2	2	BEARING	1801010		ENDURO 688 LLU MAX 16X8X5	
3	2	BEARING	1804045		24ASPT ALTITUDE MP BEARING 6809 45X58X7	
4	6	BEARING	1807042		ENDURO BEARING 6900 2RS MAX TYPE, 22X10X6 SIZE	
5	2	BEARING SPACER	1804049		FORWARD SHOCK REDUCER 10 MM THRU	
6	1	BOLT	1804033	10	FORWARD SHOCK BOLT, M10x1.0, L:72	Apply grease to pivot bolts, and Loctite 243
7	1	BOLT	1804036	10	TOP LINK, TOP BOLT, M10x1.0, L:51, 6MMHEX	Apply grease to pivot bolts, and Loctite 243
8	1	BOLT	1804037		MAIN PIVOT BOLT (M43x1.5, OD: 43, L:70, ID BSA)	Apply grease to MP bolt and screw threads.
9	1	BOLT	1804040	10	LOWER LINK SHOCK BOLT, M8x1.0, L:51	Apply grease to pivot bolts, and Loctite 243
10	1	BOLT	1804047	10	LOWER LINK LOWER BOLT M10x1.0, L81.5	Apply grease to pivot bolts, and Loctite 243
11	1	BOLT	1804053	10	TOP LINK LOWER BOLT M10x1.0, L74	Apply grease to pivot bolts, and Loctite 243
12	7	BOLT	1804060	< 1	M4x0.7 10MM HEX BUTTON HEAD	a) Apply grease (alloy only). b) Apply Loctite 243 (blue) (carbonyl)
13	1	BOLT	1805169	10	LOWER 27.5 LINK SHOCK BOLT, M8x1.0, L:51, 11 MM THREAD	Apply grease to pivot bolts, and Loctite 243
14	2	BRG CUP	1800031		BEARING EYELET FOR 16x8X5 BRG	
15	2	BUSHING, FOX	N/A		FOX_LIGUS_BUSHING	
16	1	CHAINGUIDE	3391004		ONEUP CHAINGUIDE ASSEMBLY (1C0686)	
17	1	CHAINGUIDE BA	1394003		BASEPLATE FOR CHAINGUIDE	
18	1	CHAINGUIDE SLII	3391002		SLIDING PART OF CHAINGUIDE	
19	1	COMPLETE COVER	1994031		PENALTYBOX 2 COMPLETE COVER SUB-ASSEMBLY	Carbon only.
20	1	FLIP CHIP	1804032		RIDE 4 CHIP - THREADED, M10x1.0, T:10	
21	1	FLIP CHIP	1804034		RIDE 4 CHIP - 10 mm THRU	
22	1	FLIP CHIP	1804041		LOWER LINK FLIP CHIP 29 AND MX	
23	1	FLIP CHIP	1804043		LOWER LINK CHIP THREAD, M8x1.0, 29 OR MX	
24	1	FRONT TRIANGLE	B064112CBN		2024 ALTITUDE CARBON FRONT TRIANGLE - SIZE LARGE	
25	1	HANGER	1092003		MY22 REAR DER. HANGER, M12X1, UDH COMPATIBLE	
26	1	HANGER NUT	1801008	20	RMB UDH HANGER NUT, 7075_T6, HARD BLACK ANODIZED	Apply Loctite 243 (blue) to threads.
27	1	HT PORT COVER	1803012		2023 SLAYER CARBON HT PORT COVER, RIGHT	Carbon only.
28	1	HT PORT COVER	1803013		2023 SLAYER CARBON HT PORT COVER, LEFT	Carbon only.
29	1	LINK	1094001		2024 ALTITUDE TOP LINK	
30	1	LINK	1094002		2024 ALTITUDE LOWER LINK, 29"	Use 1804040 shock bolt with 29/MX link.
31	1	LINK	1094003		MY24 ALTITUDE LOWER LINK, 27.5" SIZE SMALL	Use 1805169 shock bolt for 27.5" link.
32	1	MUD GUARD	1994026		2024 ALTITUDE REAR TRIANGLE MUD GUARD	
33	1	MUD GUARD	1994027		2024 ALTITUDE SHOCK MUD GUARD	
34	1	NUT	1804038	25	MP NUT M43X1.5, T:7, OD:54.5	Install using RMB BB/MP Tool (PART # 1804039).
35	2	PORT COVER	1093011		ALLOY CABLE PORT COVER DOUBLE HOLE	Alloy only.
36	1	PORT COVER	1093012		ALLOY CABLE PORT COVER BLANK	Alloy only.
37	1	PORT COVER	1093013		ALLOY CABLE PORT COVER SINGLE 4mm HOLE	Alloy only.
38	2	PORT COVER	1093014		ALLOY CABLE PORT COVER SINGLE 5mm HOLE	Alloy only.
39	1	PROTECTOR	3704055		2024 ALTITUDE CHAIN STAY UPPER PROTECTOR	
40	1	PROTECTOR	3704056		2024 ALTITUDE SEAT STAY PROTECTOR	
41	2	PROTECTOR	3704057		2024 ALTITUDE TAILGATE PROTECTOR	
42	1	PROTECTOR	3704058		2024 ALTITUDE CHAIN STAY LOWER PROTECTOR	
43	1	PROTECTOR	3704059		2024 ALTITUDE DOWN TUBE PROTECTOR	Alloy
44	1	PROTECTOR	3704108		MY24 ALTITUDE CARBON DOWN TUBE PROTECTOR	Carbon
45	1	REAR TRIANGLE	I054112CBN		2024 ALTITUDE CARBON REAR TRIANGLE - SIZE LARGE & X-LARGE	
46	2	SCREW	1800024-BK	< 1	C'SUNK SOCKET SCREW, M4x10MM, 10.9 STEEL, BLACK	Apply grease to screw threads (carbon only).
47	1	SCREW	1804055	< 2	C'SUNK SOCKET SCREW, M5X0.8, L:12 MM, 3MM HEX, SS	Apply Loctite 243 (blue) to threads.
48	2	SCREW	1804067	< 1	M4x0.7 DOME HEAD SCREW, L:12, HEX 2.5	Apply grease to screw threads.
49	4	SCREW	1804068	< 1	M4x0.7 DOME HEAD SCREW, L:7, HEX 2.5	Apply grease to screw threads.
50	1	SHOCK	N/A		REAR SHOCK, 230X60	
51	1	SHOCK, PIN	N/A		SHOCK PIN: ID:10 MM, L:40 MM, STEEL	
52	1	SLEEVE	1800010		SS BEARING SLEEVE, ID:10, OD:14, L:41, NECKED	
53	1	SLEEVE	1804035		TOP LINK UPPER SLEEVE, OD:14, ID: 10.2, L:22	
54	1	SLEEVE	1804044		MAIN PIVOT SLEEVE L:29 ID:43 OD:49	
55	1	SLEEVE	1804048		LOWER LINK SLEEVE, ID:10.2, OD:14, L:50	
56	1	SLEEVE	1807028		BEARING EYELET CENTRE SLEEVE	
57	6	SPACER	1800009		LINK BEARING SPACER, OD:22, ID:10, T:2.5	
58	2	SPACER	1804042		LOWER LINK SHOCK SPACER, 8 MM THRU	
59	2	SPACER	1804046		MP BEARING SPACER ID:45 OD:57 T:8	
60	1	SUBFRAME S-A	1814004		PENALTYBOX 2 MOUNTING FRAME	Carbon only.
61	1	TOOL	1804039		BOTTOM BRACKET TOOL	BB/MP nut installation tool. Ensure tool is
62	3	WASHER	1800019		WASHER ID: 10.2, OD: 15.5, T: 1	
63	1	WASHER	1801009		WASHER, 20X24X0.5MM, 304 SS	
64	1	WASHER	3227006		WASHER, 12x19x0.5MM, 304 SS	
65	2	WASHER	N/A		SHOCK CRUSH WASHER	
66	1	LINK	1094001P		2024 ALTITUDE TOP LINK POLISHED	
67	1	LINK	1094002P		2024 ALTITUDE LOWER LINK, 29" POLISHED	
68	1	LINK	1094003P		MY24 ALTITUDE LOWER LINK, 27.5" SIZE SMALL POLISHED	
1	1	HEAD SET CUP	1194002		FSA 5MM OFFSET OVAL CUPS W/ORING CR BIKES	
1	1	HEAD SET CUP	1194004		FSA 5MM OFFSET CUPS AL BIKES	
1	1	HEADSET	1194001		FSA NO.85 1.5" OMM OFFSET OVAL CUPS STAINLESS	
1	1	HEADSET	1194003		FSA ZS56/66 OMM OFFSET HS STAINLESS STEEL	

ELENCO KIT PARTI PICCOLE

2024 ALTITUDE CARBON ALLOY					
#	QTY	ITEM	PART NO.	SUPPLIER	REVISION DESCRIPTION
1814020					
ZCA013					
2024 ALTITUDE UPPER LINK KIT WITH BEARINGS					
29	1	LINK	1094001	PTW385	2024 ALTITUDE TOP LINK
4	2	BEARING	1807042	PUS098	ENDURO BEARING 6900 2RS MAX TYPE, 22X10X6 SIZE
52	1	SLEEVE	1800010	PTW047	SS BEARING SLEEVE, ID:10, OD:14, L:41, NECKED
1814021					
ZCA013					
2024 ALTITUDE 29 LOWER LINK KIT WITH BEARINGS					
30	1	LINK	1094002	PTW385	2024 ALTITUDE LOWER LINK, 29"
4	2	BEARING	1807042	PUS098	ENDURO BEARING 6900 2RS MAX TYPE, 22X10X6 SIZE
55	1	SLEEVE	1804048	PTW047	LOWER LINK SLEEVE, ID:10.2, OD:14, L:50
3	2	BEARING	1804045	PUS098	24ASPT ALTITUDE MP BEARING 6809 45X58X7
54	1	SLEEVE	1804044	PTW047	MAIN PIVOT SLEEVE L:29 ID:43 OD:49
1814022					
ZCA013					
2024 ALTITUDE 27.5 LOWER LINK KIT WITH BEARINGS					
31	1	LINK	1094003	PTW385	MY24 ALTITUDE LOWER LINK, 27.5" SIZE SMALL
4	2	BEARING	1807042	PUS098	ENDURO BEARING 6900 2RS MAX TYPE, 22X10X6 SIZE
55	1	SLEEVE	1804048	PTW047	LOWER LINK SLEEVE, ID:10.2, OD:14, L:50
3	2	BEARING	1804045	PUS098	24ASPT ALTITUDE MP BEARING 6809 45X58X7
54	1	SLEEVE	1804044	PTW047	MAIN PIVOT SLEEVE L:29 ID:43 OD:49
1814020P					
ZCA013					
2024 ALTITUDE UPPER LINK POLISHED KIT WITH BEARING					
66	1	LINK	1094001P	PTW385	2024 ALTITUDE TOP LINK POLISHED
4	2	BEARING	1807042	PUS098	ENDURO BEARING 6900 2RS MAX TYPE, 22X10X6 SIZE
52	1	SLEEVE	1800010	PTW047	SS BEARING SLEEVE, ID:10, OD:14, L:41, NECKED
1814021P					
ZCA013					
2024 ALTITUDE 29 LOWER LINK POLISHED KT WITH BEARING					
67	1	LINK	1094002P	PTW385	2024 ALTITUDE LOWER LINK, 29" POLISHED
4	2	BEARING	1807042	PUS098	ENDURO BEARING 6900 2RS MAX TYPE, 22X10X6 SIZE
55	1	SLEEVE	1804048	PTW047	LOWER LINK SLEEVE, ID:10.2, OD:14, L:50
3	2	BEARING	1804045	PUS098	24ASPT ALTITUDE MP BEARING 6809 45X58X7
54	1	SLEEVE	1804044	PTW047	MAIN PIVOT SLEEVE L:29 ID:43 OD:49
1814022P					
ZCA013					
2024 ALTITUDE 27.5 LOWER LINK POLISH KT WITH BEARING					
68	1	LINK	1094003P	PTW385	MY24 ALTITUDE LOWER LINK, 27.5" SIZE SMALL POLISHED
4	2	BEARING	1807042	PUS098	ENDURO BEARING 6900 2RS MAX TYPE, 22X10X6 SIZE
55	1	SLEEVE	1804048	PTW047	LOWER LINK SLEEVE, ID:10.2, OD:14, L:50
3	2	BEARING	1804045	PUS098	24ASPT ALTITUDE MP BEARING 6809 45X58X7
54	1	SLEEVE	1804044	PTW047	MAIN PIVOT SLEEVE L:29 ID:43 OD:49
1812002					
PTW047					
2022 HANGER KIT 12 x1.0					
25	1	HANGER	1092003	PTW047	MY22 REAR DER. HANGER, M12X1, UDH COMPATIBLE
26	1	HANGER NUT	1801008	PTW047	RMB UDH HANGER NUT, 7075_T6, HARD BLACK ANODIZED
63	1	WASHER	1801009	PTW047	WASHER, 20X24X0.5MM, 304 SS
1814018					
PTW047					
2024 ALTITUDE PIVOT BOLT KIT					
7	1	BOLT	1804036	PTW047	TOP LINK, TOP BOLT, M10x1.0, L:51, 6MMHEX
10	1	BOLT	1804047	PTW047	LOWER LINK LOWER BOLT M10x1.0, L81.5
11	1	BOLT	1804053	PTW047	TOP LINK LOWER BOLT M10x1.0, L74
57	6	SPACER	1800009	PTW047	LINK BEARING SPACER, OD:22, ID:10, T:2.5
62	3	WASHER	1800019	PTW047	WASHER ID: 10.2, OD: 15.5, T: 1
1814019					
PTW047					
2024 ALTITUDE MAIN PIVOT KIT					
8	1	BOLT	1804037	PTW047	MAIN PIVOT BOLT (M43x1.5, OD: 43, L:70, ID BSA)
34	1	NUT	1804038	PTW047	MP NUT M43X1.5, T:7, OD:54.5
59	2	SPACER	1804046	PTW047	MP BEARING SPACER ID:45 OD:57 T:8
1814023					
PTW047					
2024 ALTITUDE MAIN PIVOT TOOL					
61	1	TOOL	1804039	PTW047	BOTTOM BRACKET TOOL

ELENCO KIT PARTI PICCOLE

		1814024	ZCA013
3	2 BEARING	1804045	PUS098
4	6 BEARING	1807042	PUS098
53	1 SLEEVE	1804035	PTW047
		1814025	ZCA013
3	2 BEARING	1804045	PUS098
		1814026	PTW047
6	1 BOLT	1804033	PTW047
9	1 BOLT	1804040	PTW047
		1814058	PTW047
6	1 BOLT	1804033	PTW047
13	1 BOLT	1805169	
		1814027	ZCA013
2	2 BEARING	1801010	PUS098
56	1 SLEEVE	1807028	PTW047
14	2 BRG CUP	1800031	PTW047
58	2 SPACER	1804042	PTW047
		1814028	PTW047
5	2 BEARING SPACER	1804049	PTW047
		1812007	
1	1 AXLE, REAR	3222000	PTW047
64	1 WASHER	3227006	PTW047
		1813467	PTW047
27	1 HT PORT COVER	1803012	PTW047
28	1 HT PORT COVER	1803013	PTW047
46	2 SCREW, M4X10	1800024-BK	PTW047
		1814039	ZCA013
12	3 BOLT	1804060	PTW047
35	2 PORT COVER	1093011	P0072
36	1 PORT COVER	1093012	P0072
37	1 PORT COVER	1093013	P0072
38	2 PORT COVER	1093014	P0072
		1814040	ZCA013
12	1 BOLT	1804060	PTW047
38	1 PORT COVER	1093014	P0072
		1814029	PTW047
20	1 FLIP CHIP	1804032	PTW047
21	1 FLIP CHIP	1804034	PTW047
		1814031	PTW047
22	1 FLIP CHIP	1804041	PTW047
23	1 FLIP CHIP	1804043	PTW047
		1814032	ZCA013
39	1 PROTECTOR	3704055	PTW110
40	1 PROTECTOR	3704056	PTW110
41	2 PROTECTOR	3704057	PTW110
42	1 PROTECTOR	3704058	PTW110
43	1 PROTECTOR	3704059	PTW110

2024 ALTITUDE PIVOT BEARING KIT

24ASPT ALTITUDE MP BEARING 6809 45X58X7
 ENDURO BEARING 6900 2RS MAX TYPE, 22X10X6 SIZE
 TOP LINK UPPER SLEEVE, OD:14, ID: 10.2, L:22

2024 ALTITUDE MAIN PIVOT BEARING ONLY KIT

24ASPT ALTITUDE MP BEARING 6809 45X58X7

2024 ALTITUDE SHOCK BOLT KIT

FORWARD SHOCK BOLT, M10x1.0, L:72
 LOWER LINK SHOCK BOLT, M8x1.0, L:51

2024 ALTITUDE SHOCK BOLT KIT SM

FORWARD SHOCK BOLT, M10x1.0, L:72
 LOWER 27.5 LINK SHOCK BOLT, M8x1.0, L:51, 11 MM THREAD

2024 ALTITUDE SHOCK BEARING EYELET KIT

ENDURO 688 LLU MAX 16X8X5
 BEARING EYELET CENTRE SLEEVE
 BEARING EYELET FOR 16X8X5 BRG
 LOWER LINK SHOCK SPACER, 8 MM THRU

2024 ALTITUDE FORWARD SHOCK REDUCER KIT

FORWARD SHOCK REDUCER 10 MM THRU

AXLE KIT BOOST 12X1.0

REAR AXLE 12X1.0 L:173MM, HARD BLACK ANODIZE
 WASHER, 12x19x0.5MM, 304 SS

NEW HEAD TUBE PANEL KIT (FROM 2023)

2023 SLAYER CARBON HT PORT COVER, RIGHT
 2023 SLAYER CARBON HT PORT COVER, LEFT
 C'SUNK SOCKET SCREW, M4x10MM, 10.9 STEEL, BLACK

ALLOY FRAME HT CABLE PORT KIT

M4x0.7 10MM HEX BUTTON HEAD
 ALLOY CABLE PORT COVER DOUBLE HOLE
 ALLOY CABLE PORT COVER BLANK
 ALLOY CABLE PORT COVER SINGLE 4mm HOLE
 ALLOY CABLE PORT COVER SINGLE 5mm HOLE

ALLOY FRAME CS CABLE PORT KIT

M4x0.7 10MM HEX BUTTON HEAD
 ALLOY CABLE PORT COVER SINGLE 5mm HOLE

RIDE 4 THREADED 10MM CHIP KIT

RIDE 4 CHIP - THREADED, M10x1.0, T:10
 RIDE 4 CHIP - 10 mm THRU

2024 ALTITUDE LOWER LINK FLIP CHIP

LOWER LINK FLIP CHIP 29 AND MX
 LOWER LINK CHIP THREAD, M8x1.0, 29 OR MX

2024 ALTITUDE ALLOY PROTECTION KIT

2024 ALTTIUDE CHAIN STAY UPPER PROTECTOR
 2024 ALTTIUDE SEAT STAY PROTECTOR
 2024 ALTTIUDE TAILGATE PROTECTOR
 2024 ALTTIUDE CHAIN STAY LOWER PROTECTOR
 2024 ALTTIUDE DOWN TUBE PROTECTOR

ELENCO KIT PARTI PICCOLE

39	1 PROTECTOR	1814062	ZCA013
		3704055	PTW110
40	1 PROTECTOR	3704056	PTW110
41	2 PROTECTOR	3704057	PTW110
42	1 PROTECTOR	3704058	PTW110
44	1 PROTECTOR	3704108	PTW110
		1814033	ZCA013
32	1 MUD GUARD	1994026	P0072
49	4 SCREW	1804068	PTW047
33	1 MUD GUARD	1994027	P0072
48	2 SCREW	1804067	PTW047
		1814034	ZCA013
16	1 CHAINGUIDE	3391004	PTW021
17	1 CHAINGUIDE BASE	1394003	PTW047
18	1 CHAINGUIDE SLIDE	3391002	PTW047
47	1 SCREW	1804055	PTW047
		1814042	PTW047
19	1 COMPLETE COVER S-A	1994031	PTW047
		1814043	ZCA013
	2 M5 BARREL	1994049	P0072
	2 SCREW	1804074	PTW047
		1814044	ZCA013
60	1 SUBFRAME S-A	1814004	P0072
12	7 BOLT	1804060	PTW047
	1 WRAP	AC00340S1	P0064
	1 BAG	AC00330S1	P0064
		1814050	ZCA013
	1 HEAD SET CUP	1194002	PUS105
		1814051	ZCA013
	1 HEAD SET CUP	1194004	PUS105
		1814052	ZCA013
	1 HEADSET	1194001	PUS105
		1814053	ZCA013
	1 HEADSET	1194003	PUS105

2024 ALTITUDE CARBON PROTECTION KIT

2024 ALTTIUDE CHAIN STAY UPPER PROTECTOR
2024 ALTTIUDE SEAT STAY PROTECTOR
2024 ALTTIUDE TAILGATE PROTECTOR
2024 ALTTIUDE CHAIN STAY LOWER PROTECTOR
MY24 ALTITUDE CARBON DOWN TUBE PROTECTOR

2024 ALTITUDE MUD GUARD KIT

2024 ALTITUDE REAR TRIANGLE MUD GUARD
M4x0.7 DOME HEAD SCREW, L:7, HEX 2.5
2024 ALTTIUDE SHOCK MUD GUARD
M4x0.7 DOME HEAD SCREW, L:12, HEX 2.5

2024 ALTITUDE CHAIN GUIDE

ONEUP CHAINGUIDE ASSEMBLY (1C0686)
BASEPLATE FOR CHAINGUIDE
SLIDING PART OF CHAINGUIDE
C'SUNK SOCKET SCREW, M5X0.8, L:12 MM, 3MM HEX, SS

PENALTYBOX 2 COVER KIT

PENALTYBOX 2 COMPLETE COVER SUB-ASSEMBLY
--

PENALTYBOX 2 WB MOUNT INSERT KIT

BOTTLE CAGE M5 BARREL
LOW PROFILE WATER BOTTLE SCREW M5x15

PENALTYBOX 2 FRAME MOUNT KIT

PENALTYBOX 2 MOUNTING FRAME
M4x0.7 10MM HEX BUTTON HEAD

RMB TOOL WRAP 23 OS BK

RMB TUBE BAG 23 OS BK

5M OFFSET HEAD SET CUPS KIT CR BIKES

FSA 5MM OFFSET OVAL CUPS W/ORING CR BIKES

5M OFFSET HEAD SET CUPS KIT AL BIKES

FSA 5MM OFFSET CUPS AL BIKES

OVAL OFFSET HEADSET KIT CR BIKES

FSA NO.85 1.5" 0MM OFFSET OVAL CUPS STAINLESS

OFFSET HEADSET KIT AL BIKES

FSA ZS56 66 0MM OFFSET HS STAINLESS STEEL

GARANZIA

La bicicletta Powerplay™ di Rocky Mountain è coperta da garanzia contro i difetti dei materiali e di fabbricazione come da tabella seguente:

CATEGORIA	PERIODO	NOTES
Parti del telaio	5 anni	Triangolo anteriore + triangolo posteriore, link
Hardware	1 anno	Perni, assi, ecc.
Parti della trasmissione	1 anno	Pulegge, pignoni, catena di trasmissione
Batteria	2 anni	Se conservata per più di 3 mesi, caricare la batteria ogni 3 mesi. La mancata osservanza di questa precauzione può causare danni.
Componenti	Come previsto nella garanzia originale del fabbricante	

Tutti i servizi di garanzia e assistenza post-vendita devono essere gestiti dal rivenditore autorizzato Rocky Mountain che ha venduto il telaio o la bicicletta completa. Il telaio Rocky Mountain è coperto da garanzia contro i difetti di materiale e di fabbricazione a partire dalla data di acquisto della bicicletta nuova, in base al materiale del telaio e al tipo di utilizzo della bicicletta.

La garanzia limitata di Rocky Mountain copre contro i difetti di materiale e fabbricazione anche le biciclette utilizzate in precedenza per attività personali e commerciali, come il noleggio (anche presso i bike park), i servizi di corriere, di polizia, di sicurezza e così via. La garanzia limitata si applica per il periodo di garanzia rimanente a partire dalla data di acquisto originale da Rocky Mountain. In questi casi, minuteria, cuscinetti, perni e bronzine sono esclusi dalla nostra politica di garanzia. Per tutti i reclami è necessario lo scontrino originale, la conferma di registrazione della bicicletta o un'altra prova d'acquisto.

Per i modelli di bicicletta dal 2021 in poi, la garanzia limitata originale è trasferibile ai proprietari di seconda mano. Per la validità della garanzia limitata, la registrazione della bicicletta deve essere effettuata online sia dal proprietario originale che dal proprietario di seconda mano. La fattura originale non sarà richiesta al proprietario di seconda mano.

Per trasferire la garanzia è necessario registrare la bicicletta.

Materiale del telaio / tipo di utilizzo

- Fibra di carbonio: 5 anni - Limitata*
- Alluminio: 5 anni - Limitata*
- Si rimanda alle limitazioni indicate di seguito

Altre coperture in garanzia contro i difetti dei materiali e di fabbricazione

- Rivestimento - vernice e decalcomanie: 1 anno
- Hardware del telaio, sospensioni, perni e bronzine: 1 anno

* Le maglie fanno parte del telaio.

GARANTIE

NOTA

La garanzia non è valida nei casi seguenti:

- Installazione e utilizzo di componenti, parti o accessori non originariamente previsti o compatibili con la bicicletta o il telaio venduti.
- Acquisto di una bicicletta Rocky Mountain da un rivenditore non autorizzato.
- Acquisto di una bicicletta o di un telaio Rocky Mountain su siti internet di terze parti (come eBay), indipendentemente da quanto indicato nell'inserzione.
- Lo sbiadimento della vernice causato dagli effetti della luce ultravioletta (UV) o dall'esposizione all'esterno non è coperto dalla presente garanzia limitata.
- Rocky Mountain non fornisce alcuna garanzia per eventuali danni causati alla bicicletta durante l'applicazione o la rimozione di qualsiasi pellicola protettiva.
- Graffi o scheggiature della vernice causati da sporizia, sassi, detriti stradali, trasporto su rack, ecc. non sono coperti dalla presente garanzia limitata.
- I danni al movimento centrale Press-fit causati da manutenzione, parti o materiali inadeguati non sono coperti dalla garanzia limitata Rocky Mountain.

Dettagli di cosa non è coperto dalla garanzia:

- A. La normale usura di pneumatici, tubi, freni, cavi del cambio, pastiglie dei freni, cuscinetti, ecc. non è coperta da garanzia. Il rivenditore autorizzato Rocky Mountain informerà il cliente su quali sono queste normali parti soggette a manutenzione.
- B. Danni consequenziali o qualsiasi danno causato da incidenti, uso improprio o abuso.
- C. L'assemblaggio improprio o la mancata manutenzione, la sabbatura, la levigatura, la smerigliatura, la spazzolatura a filo, la limatura, la saldatura, la brasatura, la foratura, l'anodizzazione, la riverniciatura o la cromatura non sono coperti dalla nostra garanzia e possono invalidare la garanzia degli altri componenti.
- D. L'utilizzo della bicicletta su terreni estremamente difficili come quelli che si vedono nei video di mountain bike (piste di trial, rampe, acrobazie, piste di BMX, scale, terrapieni, ecc.) è molto pericoloso e annulla la garanzia descritta nella tabella precedente. È importante notare che la piegatura di componenti, telai, forcelle, manubri, reggisella, pedali, pedivelle e cerchi delle ruote è segno di incidenti o uso improprio.
- E. È esclusa la manodopera per la sostituzione dei componenti.
- F. Rocky Mountain si riserva il diritto di riparare o sostituire a sua discrezione qualsiasi parte considerata validamente coperta da garanzia. Si prega di notare che Rocky Mountain farà tutto il possibile per assicurare la corrispondenza del colore con il componente originale, ma non può garantirla.

ESCLUSIONE E LIMITAZIONE DEI DANNI

LA GARANZIA DI ROCKY MOUNTAIN SI LIMITA ALLA RIPARAZIONE O ALLA SOSTITUZIONE DEI PRODOTTI E NON CONCEDE ALCUNA GARANZIA ESPRESSA O IMPLICITA, LEGALE O CONVENZIONALE E DECLINA QUALSIASI GARANZIA IMPLICITA DI COMMERCIALIZZABILITÀ E IDONEITÀ PER SCOPI PARTICOLARI; ROCKY MOUNTAIN NON SARÀ IN NESSUN CASO RESPONSABILE PER DANNI DIRETTI O INDIRETTI, SPECIALI, INCIDENTALI O CONSEQUENZIALI, ANCHE QUALORA ROCKY MOUNTAIN SIA STATA AVVISATA DI TALI DANNI, E LA RESPONSABILITÀ DI ROCKY MOUNTAIN SARÀ LIMITATA A 50,00 DOLLARI.



LOVE THE RIDE

**Development Center
Centre de développement
Entwicklungszentrum
Centro di Sviluppo**

1225 East Keith Road, unité 10
North Vancouver (Colombie-Britannique) V7J 1J3
Tél.: 604 980-9938 | Téléc.: 604 980-9975

**Head Office
Siège social
Hauptsitz
Sede Centrale**

9095, 25^e Avenue
Saint-Georges (Québec) G6A 1A1
Tél.: 1 800 663-2512 | Téléc.: 1 800 570-8356

Rocky Mountain, son logo et ses autres noms commerciaux appartiennent à Rocky Mountain. Certaines technologies sur les produits Rocky Mountain sont brevetées ou en attente de brevets.