

Vector Frame Dynamic Light Box Rectangle 01

VF-DYCL-LB-R-01

Vector Frame™ Dynamic Light Boxes feature 100mm (4") aluminum extrusion frames, a single-sided Intensity push-fit backlit fabric graphic and animated, programmed LED lighting. The light pattern and timing is customized to bring the display to life. Stock animations are also an option.

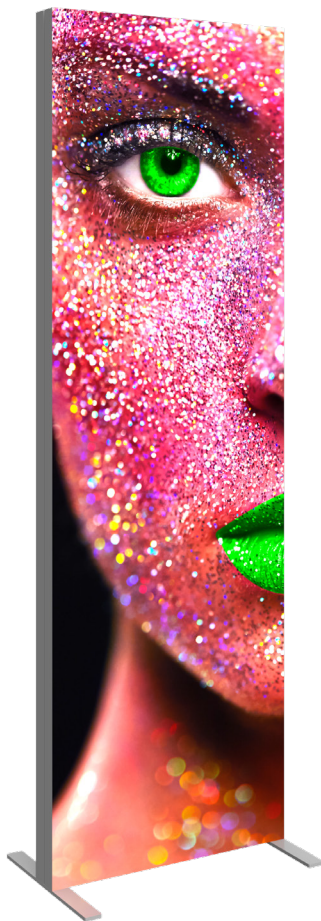

features and benefits:

- 100mm (4") silver extrusion frame
- Programmed, animated LED light curtains run the height of the frame
- Single-sided backlit Intensity push-fit fabric graphic with opaque liner
- Easy assembly
- Custom or standard animation options available
- Comes packaged with one OCE wheeled molded case for transport and storage
- Lifetime frame warranty against manufacturer defects
- 90 day light warranty

dimensions:





Hardware	Graphic			
<p>Assembled unit: 29.92" w x 94.74" h x 19.69" d 760mm(w) x 2406mm(h) x 500mm(d)</p> <p>Approximate weight without case: 80 lbs / 37 kgs</p>	<p>Refer to related graphic template for more information.</p> <p>One year graphic warranty</p> <p>Visit: https://www.theexhibitorshandbook.com/download-graphic-templates</p>			
Shipping	additional information:			
<p>Packing case(s): 1 OCE</p> <p>Shipping dimensions: OCE: Expandable case length (l) may vary 40"-66" l x 18" h x 18" d 1016mm-1677mm(l) x 458mm(h) x 458mm(d)</p> <p>Approximate case shipping weight: 24 lbs / 11 kg</p> <p>Approximate total shipping weight (includes cases & graphics): 108 lbs / 49 kgs</p>	<p>Graphic material: Backlit Intensity push-fit fabric graphic & opaque backer</p> <p>Lighting Power Requirements:</p> <table border="1"> <tr> <td>Watts: 600W</td> <td>Amps: 12A</td> <td>Volts: 115-230V</td> </tr> </table> <p>When included in a larger order, a different packaging solution will be provided to accommodate all contents of the order. Individual packaging may no longer be provided.</p>	Watts: 600W	Amps: 12A	Volts: 115-230V
Watts: 600W	Amps: 12A	Volts: 115-230V		
	 <p>This product may include the following materials for recycle: aluminum, select wood, fabric, cardboard, paper, steel, and plastics.</p>			

We are continually improving and modifying our product range and reserve the right to vary the specifications without prior notice. All dimensions and weights quoted are approximate and we accept no responsibility for variance. E&OE. See Graphic Templates for graphic bleed specifications.

Standard Animation Options

DYN-STOCK-DESIGN-

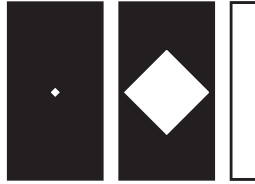
Applies to all sizes

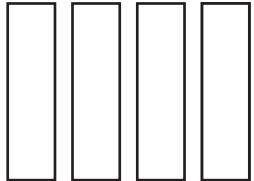
<p>Cascade CASCADE</p> 	<p>Lift Off LIFTOFF</p> 	<p>Diamond DIAMOND</p> 	<p>Firework FIREWORK</p> 
<p>All Lights ALL-LIGHT-ON</p> 			

Applies to 8' / 10' sizes only

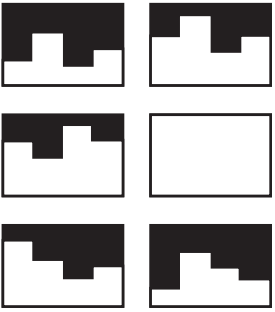
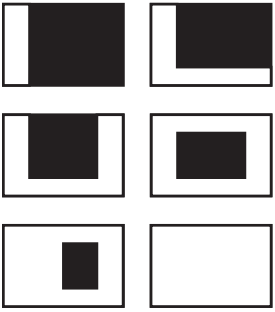
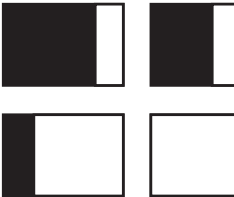
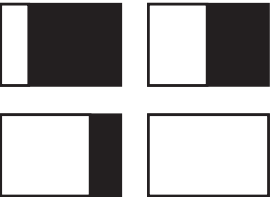
<p>Noise NOISE</p> 	<p>Snake SNAKE</p> 	<p>Wave Left WAVE-L</p> 	<p>Wave Right WAVE-R</p> 
-------------------------------------------------------------------------------------------------------------------	-------------------------------------------------------------------------------------------------------------------	--------------------------------------------------------------------------------------------------------------------------	---------------------------------------------------------------------------------------------------------------------------

Included in Your Kit

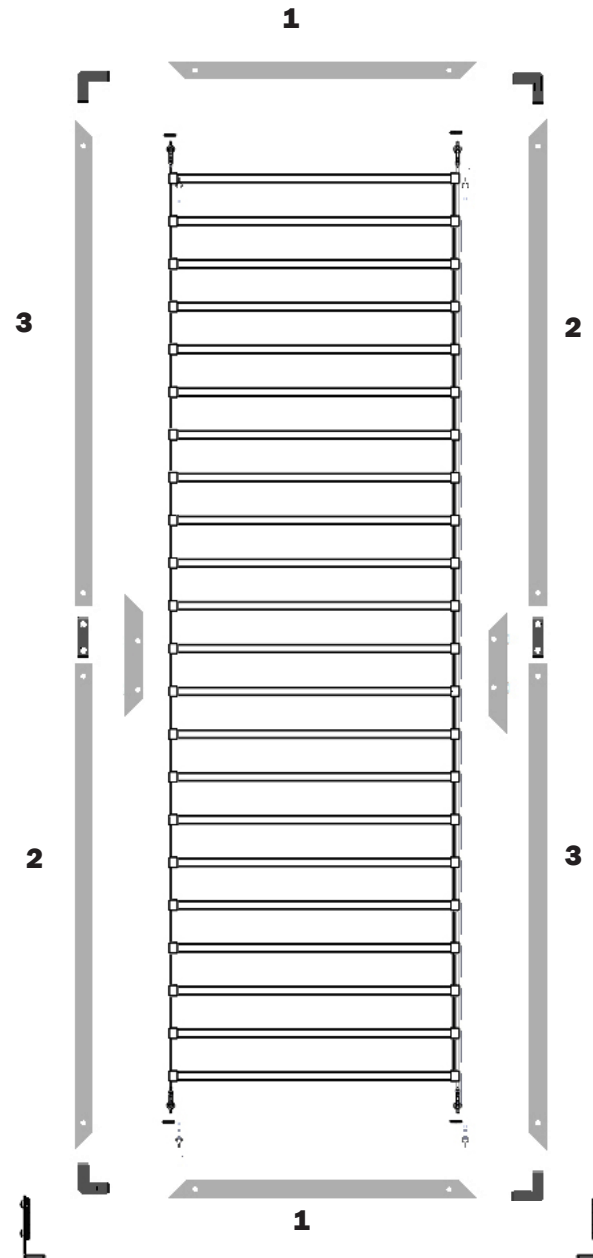
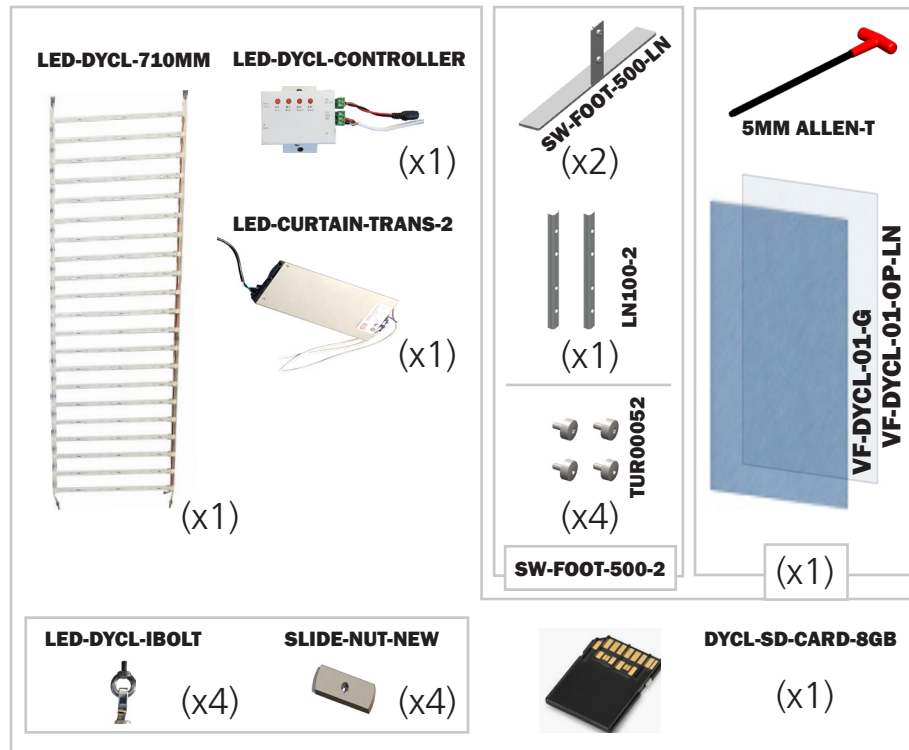
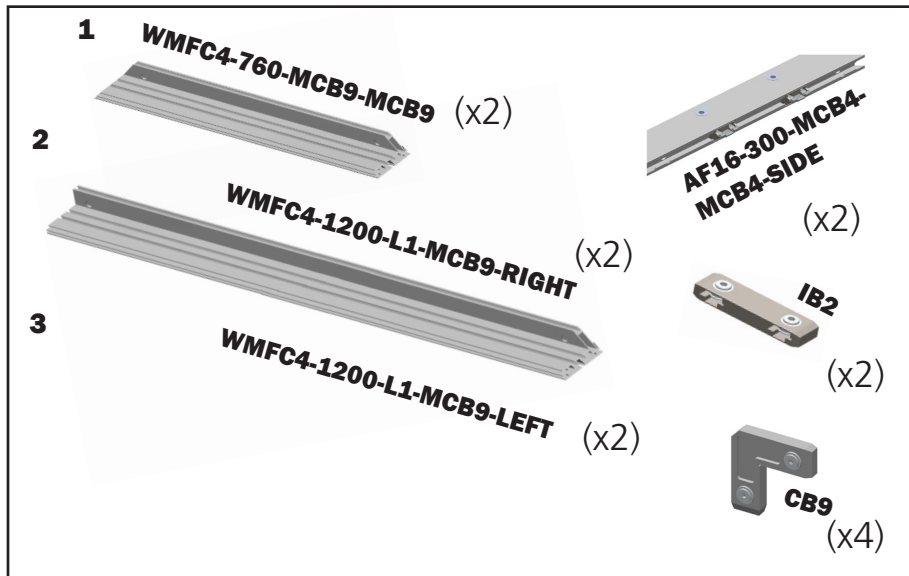

Frame Assembly

Step 1

Slide the LN100-2 into the WMFC4 Outer channel then attach the SW-FOOT-500-LN to it via the thumb screws. Repeat for both sides.

1

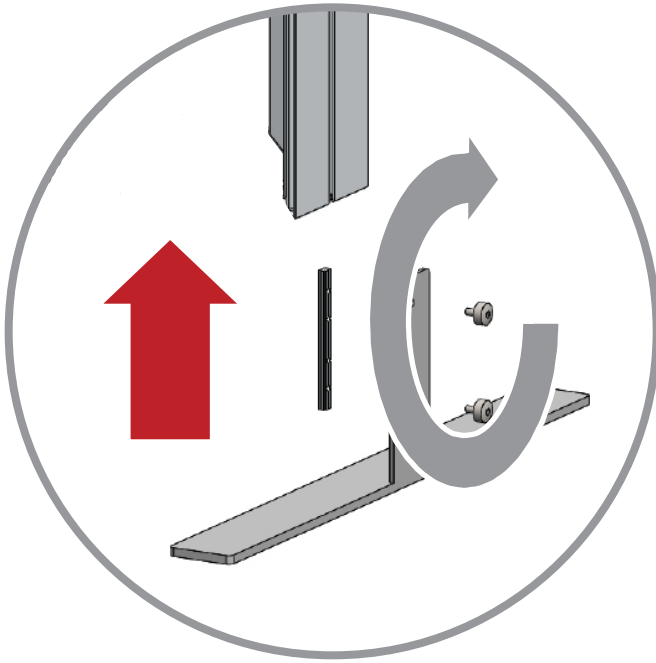

WMFC4-1200-MCB9-L1

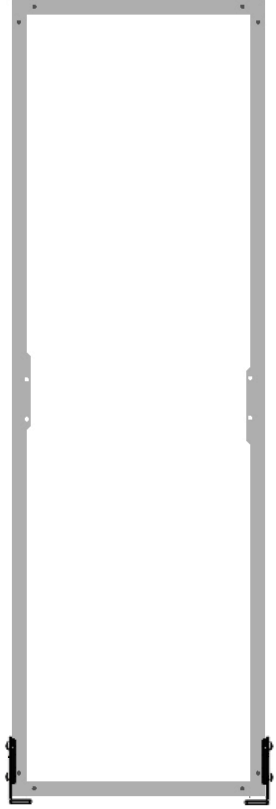

Frame Assembly

Step 2

Slot the IB2 into both sides of the WMFC-4-1200 and tighten. Repeat for both sides.

2

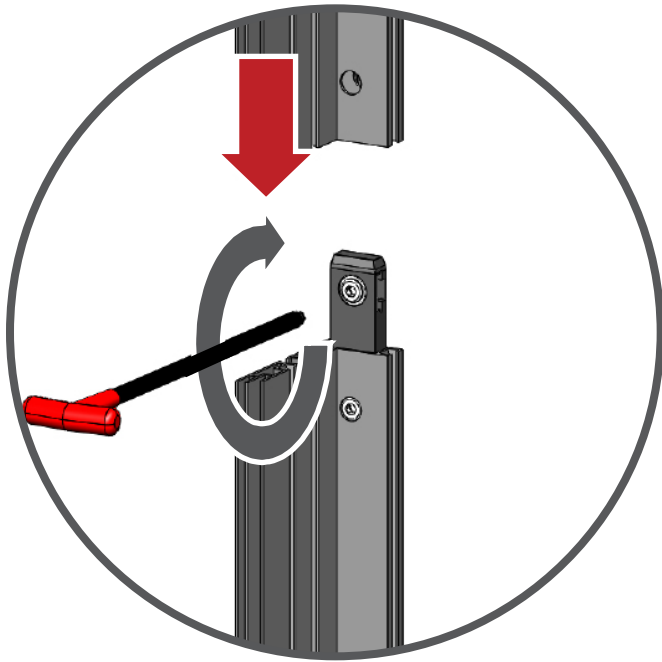

WMFC4-1200-L1-MCB9-LEFT

WMFC4-1200-L1-MCB9-RIGHT

2



WMFC4-1200-L1-MCB9-RIGHT

WMFC4-1200-L1-MCB9-LEFT

2

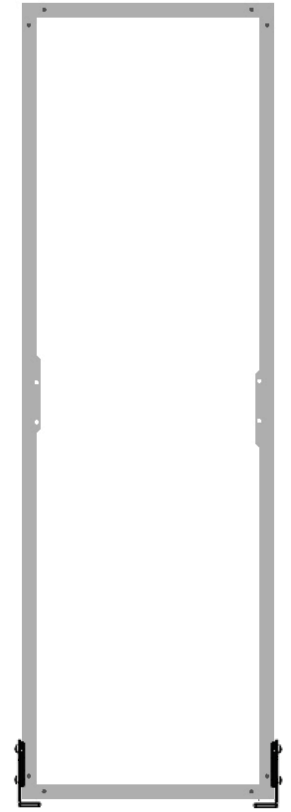

Frame Assembly

Step 3 and 4

3 Thread each of the LED-DYCL-IBOLTs through a SLIDE-NUT-NEWs. Slide the connected pieces through the middle channel of both MCB9-MCB9s. The spacing can be adjusted when the curtains are attached.

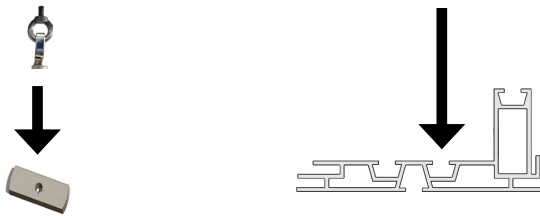

4 Slot the CB9 into both the WMFC4-1200 and WMFC4-760 then tighten. Repeat for both sides and top and bottom.

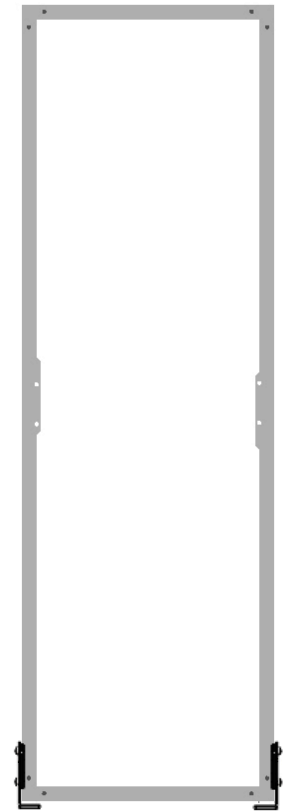
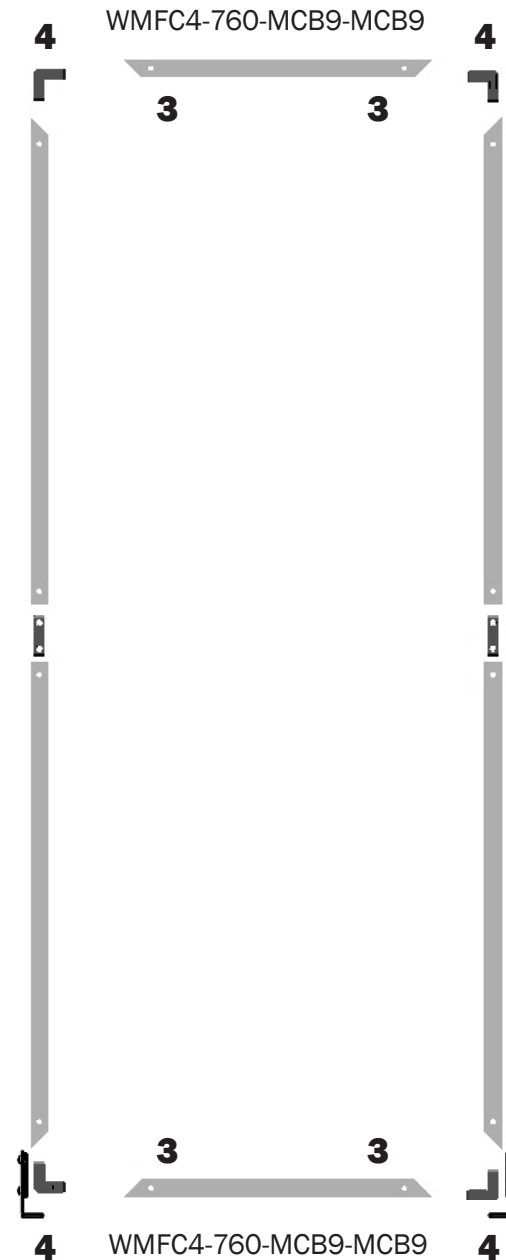
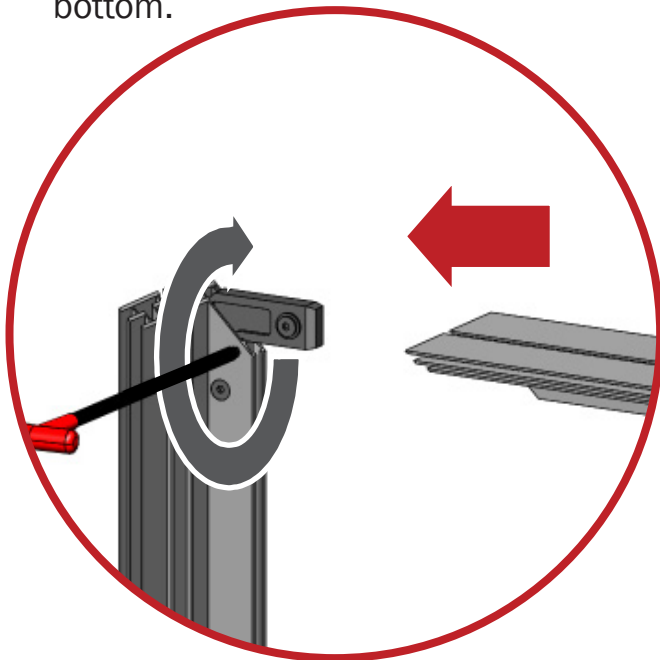

Frame Assembly

Step 5

Attach the AF16 to both WMFC4-1200s. Repeat for both sides.

4

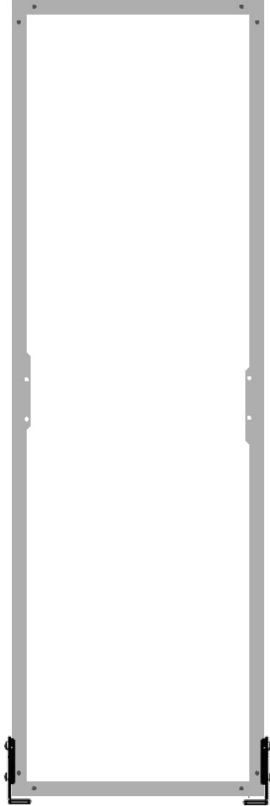
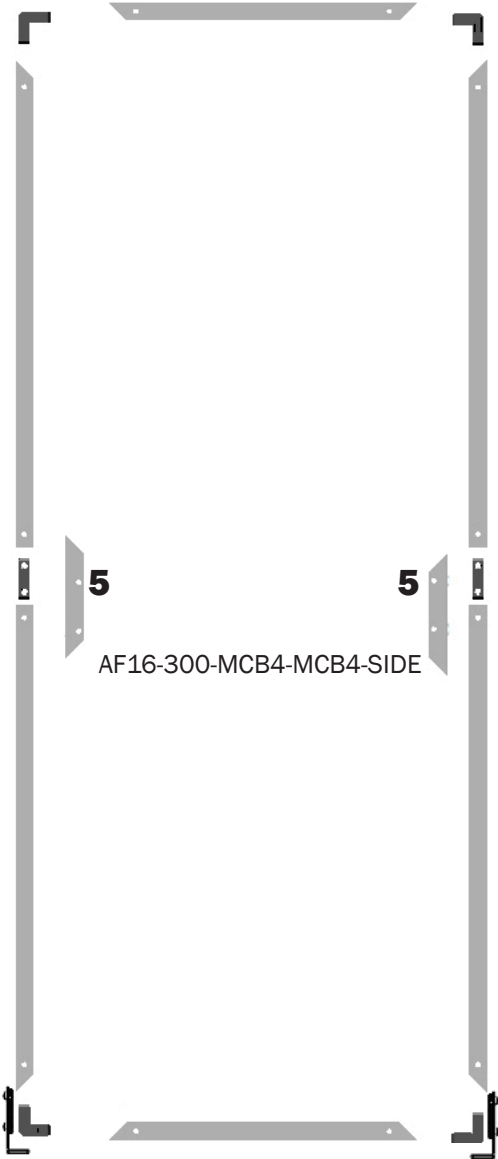
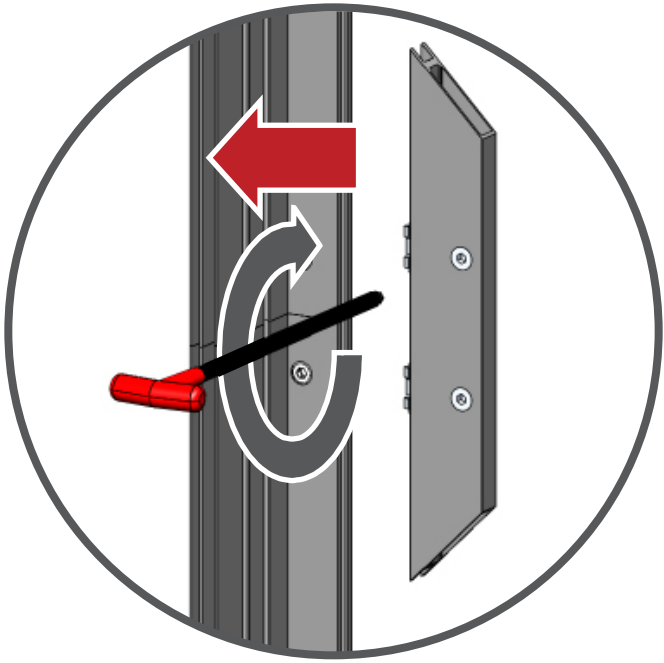

Light Curtain Attachment

Unfurl the preassembled light curtain and hang from the preinstalled eye bolts, ensuring the “UP” label is at the top of the frame, and the “DOWN” label is at the bottom.

1

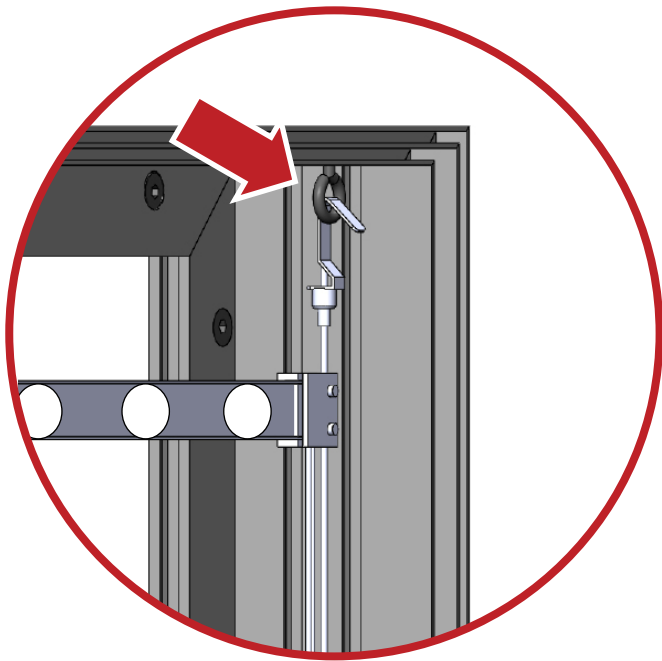

See next page for in-depth guide on how to adjust the curtain hooks, especially to reduce slack at the bottom of the frame.

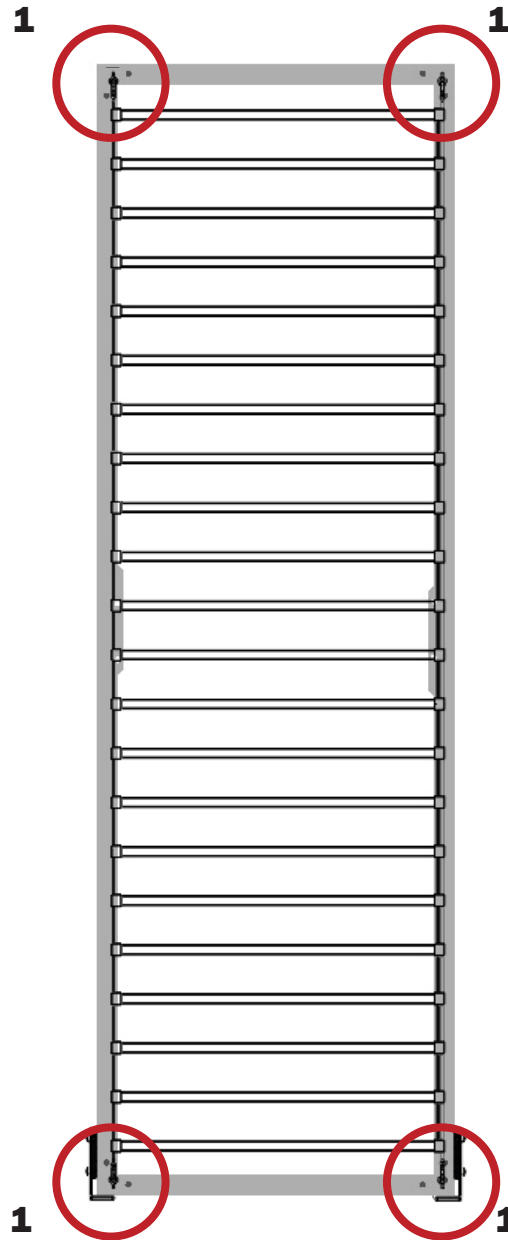

Adjusting Light Curtain Tension



Step 1
Locate the curtain light hook button.

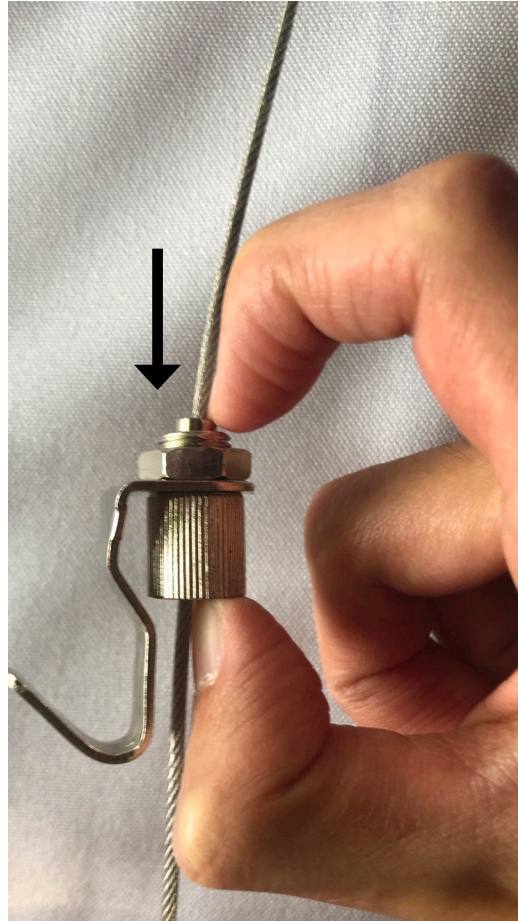

Step 2
Press down on the button releasing pressure from the curtain light cable.

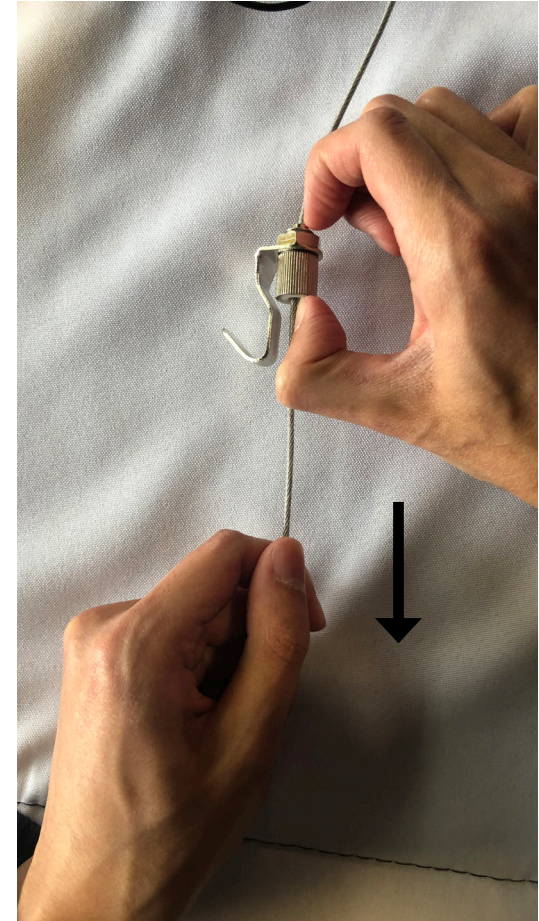

Step 3
While pressing down on the button pull the cable away from the curtain light to tighten or release tension.

Power Connection

Connect the light curtain to the transformer for power;

From the back of the frame, plug in the black plug of the light curtain to the transformer plug.

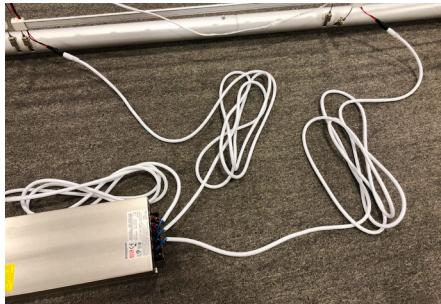

Connect the controller to a transformer for power (see image on the right);

From the back of the frame, plug in the black plug of the controller to the transformer plug.

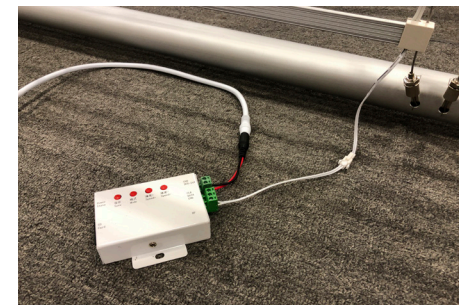
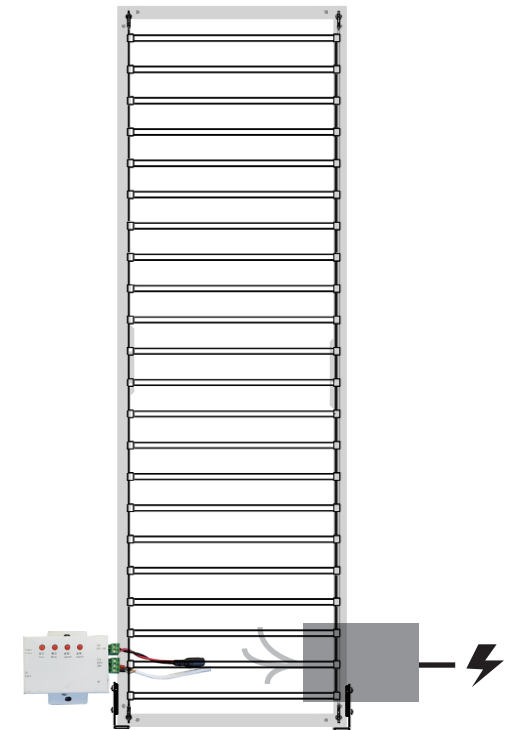
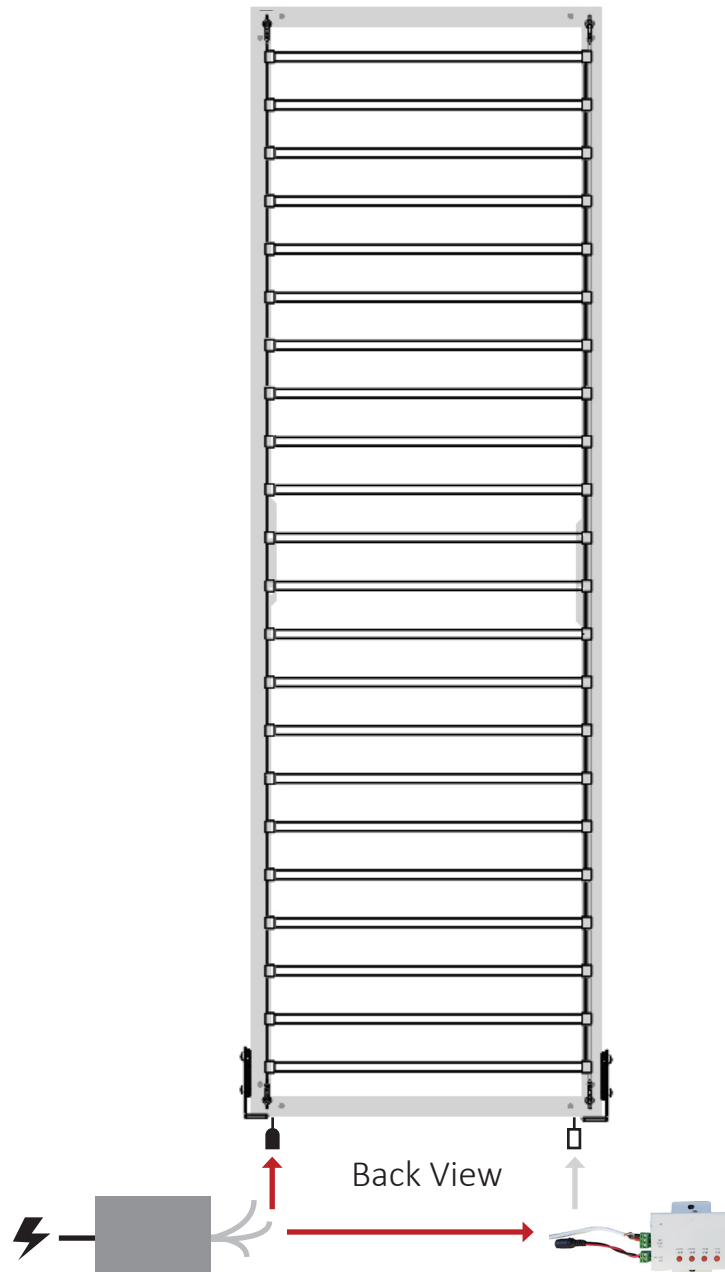

Back Liner Attachment

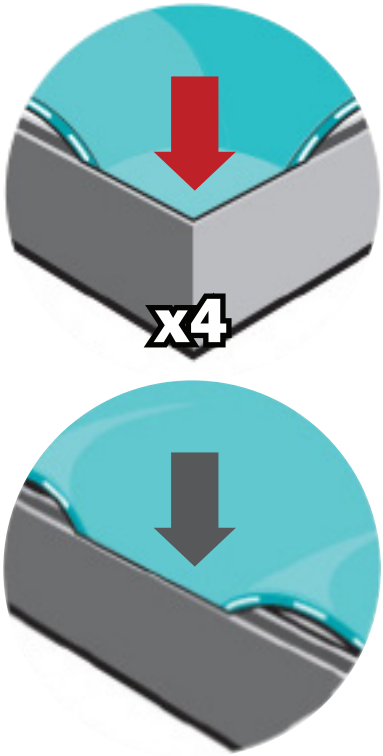

Fit backer into corners,
then "tap" into rest
of frame channel.

"Sliding down" backer
is not recommended
for best installation.

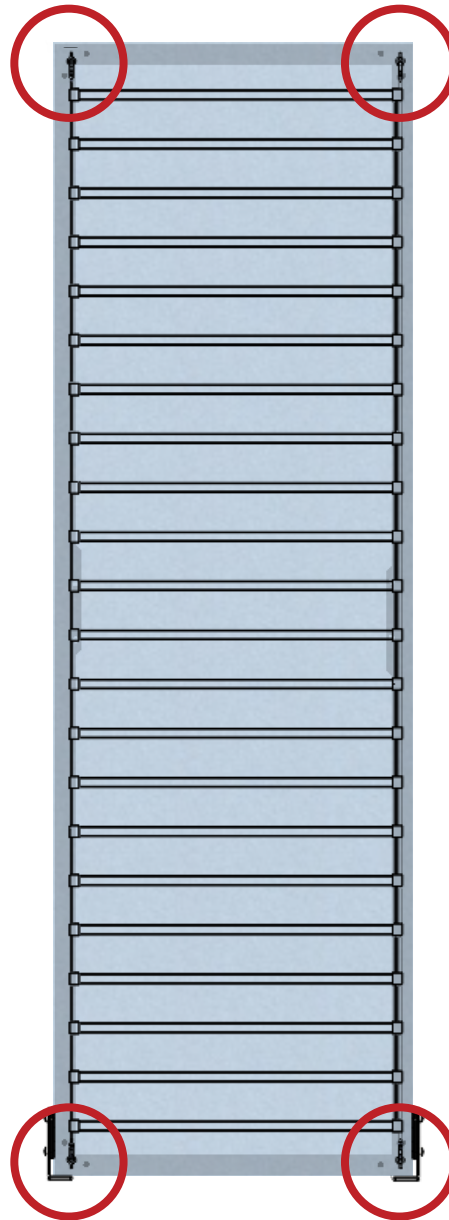

Back Liner

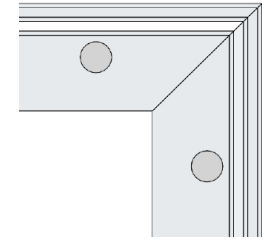

Liner
channel

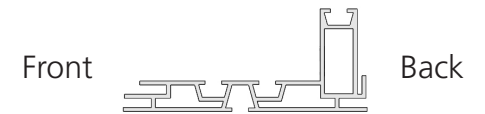

Front Graphic Attachment

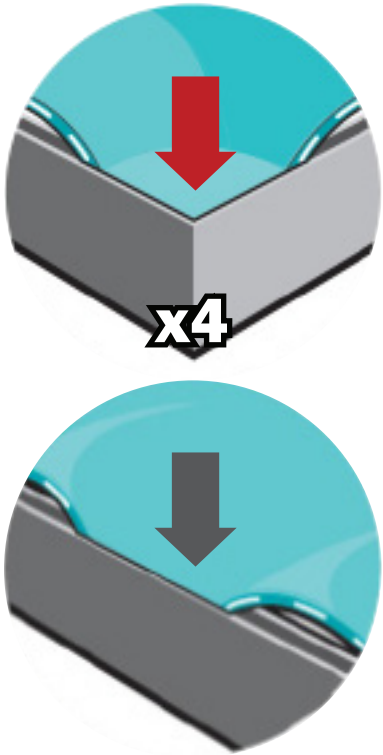

Fit front graphic into corners, then "tap" into rest of frame channel.

"Sliding down" front graphic is not recommended for best installation.

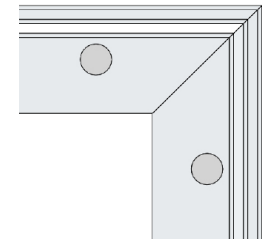
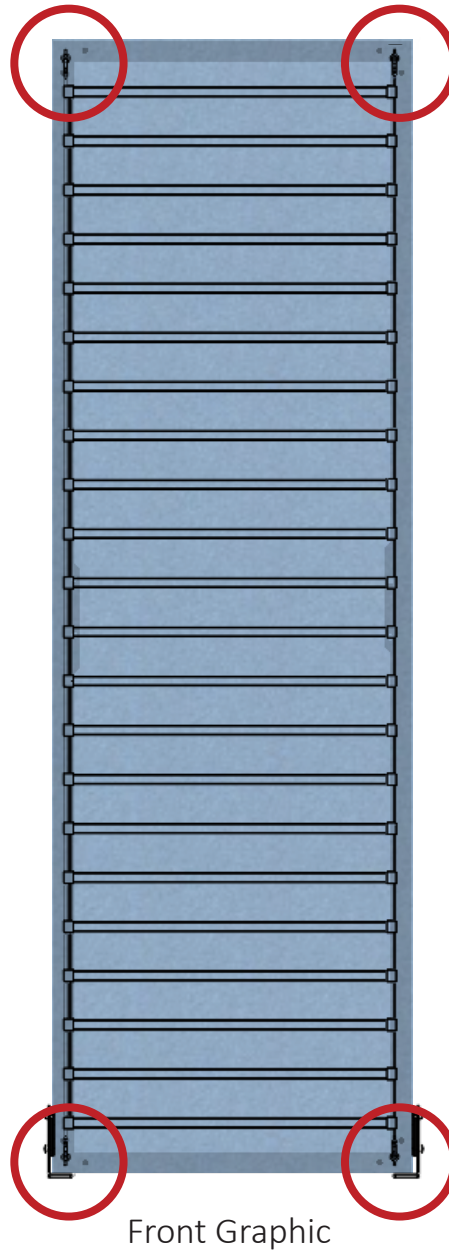

Graphic channel

Front



Back

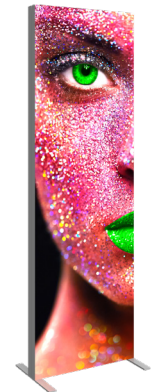

Dynamic Curtain Light Controller

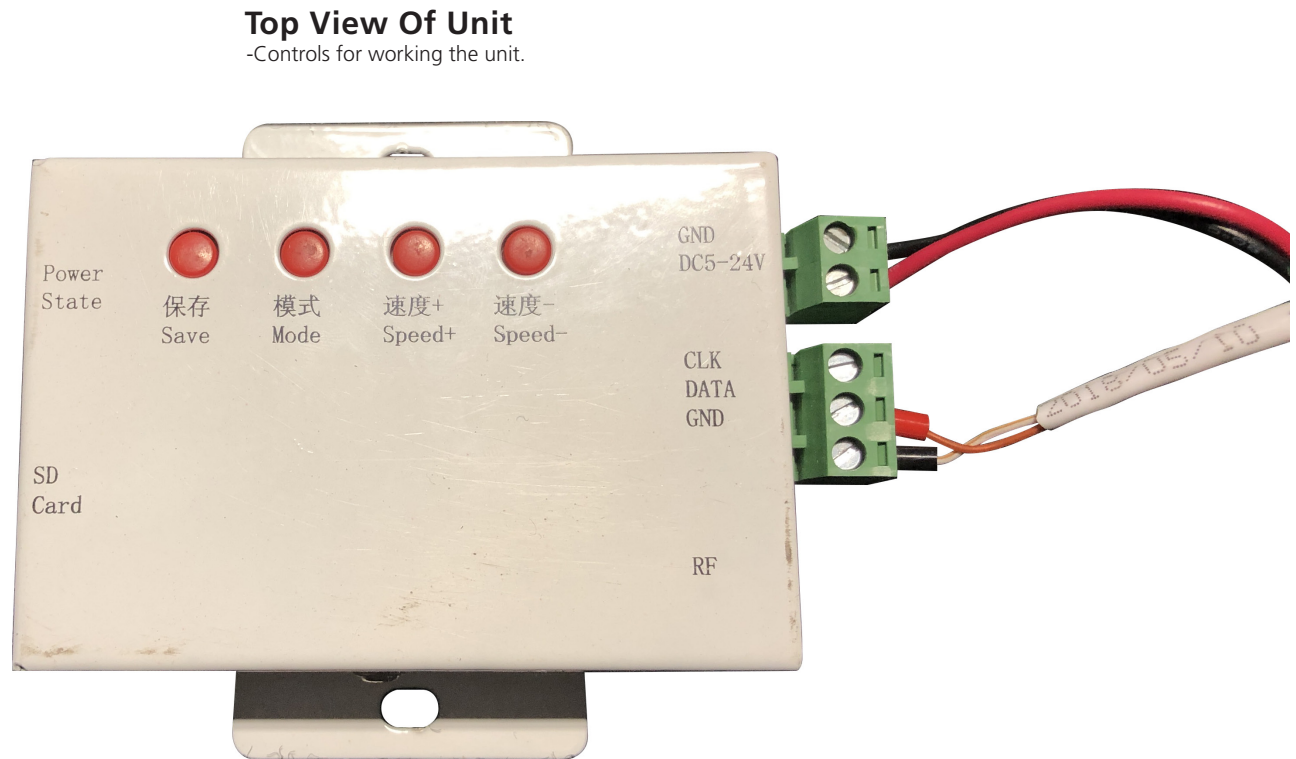
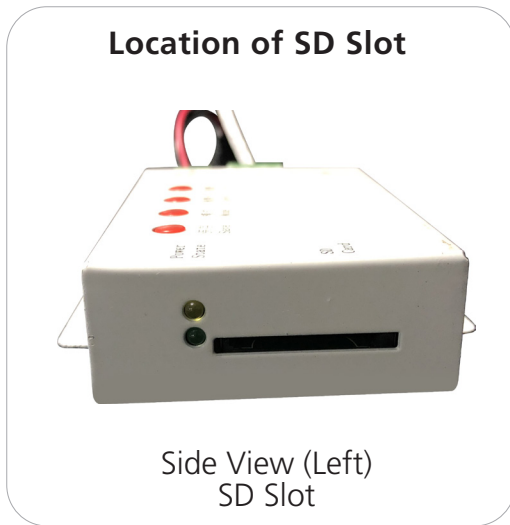

Save:
Unused

Mode:
Unused

Speed+:
Increase the speed
at which the
animation runs

Speed-:
Decrease the speed
at which the
animation runs