

Wireless Occupancy & Temperature & Light Sensor

RB11E User Manual

Copyright©Netvox Technology Co., Ltd.

This document contains proprietary technical information which is the property of NETVOX Technology. It shall be maintained in strict confidence and shall not be disclosed to other parties, in whole or in part, without written permission of NETVOX Technology. The specifications are subject to change without prior notice.

Table of Content

1. Introduction	2
2. Appearance	3
3. Main Features	4
4. Set up Instruction	5
5. Data Report	6
5.1 Example of ReportDataCmd.....	7
5.2 Example of Report configuration	7
5.3 Example for MinTime/MaxTime logic.....	9
6. IR Delay Configuration.....	10
7. Installation.....	11
7.1 Tips for installing the double-sided stickers.....	11
7.2 Tips for installing the steel nails	12
7.3 Installation battery steps	13
7.4 Installation requirements	14
7.5 Detection coverage	15
8. Information about Battery Passivation	17
8.1 To determine whether a battery requires activation	17
8.2 How to activate the battery	17
9. Important Maintenance Instruction.....	18

1. Introduction

The RB11E is a Wireless Occupancy & Temperature & Light Sensor for Netvox ClassA type devices based on the LoRaWAN open protocol and is compatible with the LoRaWAN protocol.

RB11E combines infrared detection, temperature, and illumination sensors. During infrared real-time detection, if a people or other organism which is active in the monitoring area, RB11E will detect the infrared signal and report status information to the gateway. Users can execute different instructions or scenes according to the different status configuration.

LoRa Wireless Technology:

LoRa is a wireless communication technology dedicated to long distance and low power consumption. Compared with other communication methods, LoRa spread spectrum modulation method greatly increases to expand the communication distance. Widely used in long-distance, low-data wireless communications. For example, automatic meter reading, building automation equipment, wireless security systems, industrial monitoring. Main features include small size, low power consumption, transmission distance, anti-interference ability and so on.

LoRaWAN:

LoRaWAN uses LoRa technology to define end-to-end standard specifications to ensure interoperability between devices and gateways from different manufacturers.

This device has been certified by the LoRa Alliance and is licensed to use the following logo on the product:



2. Appearance

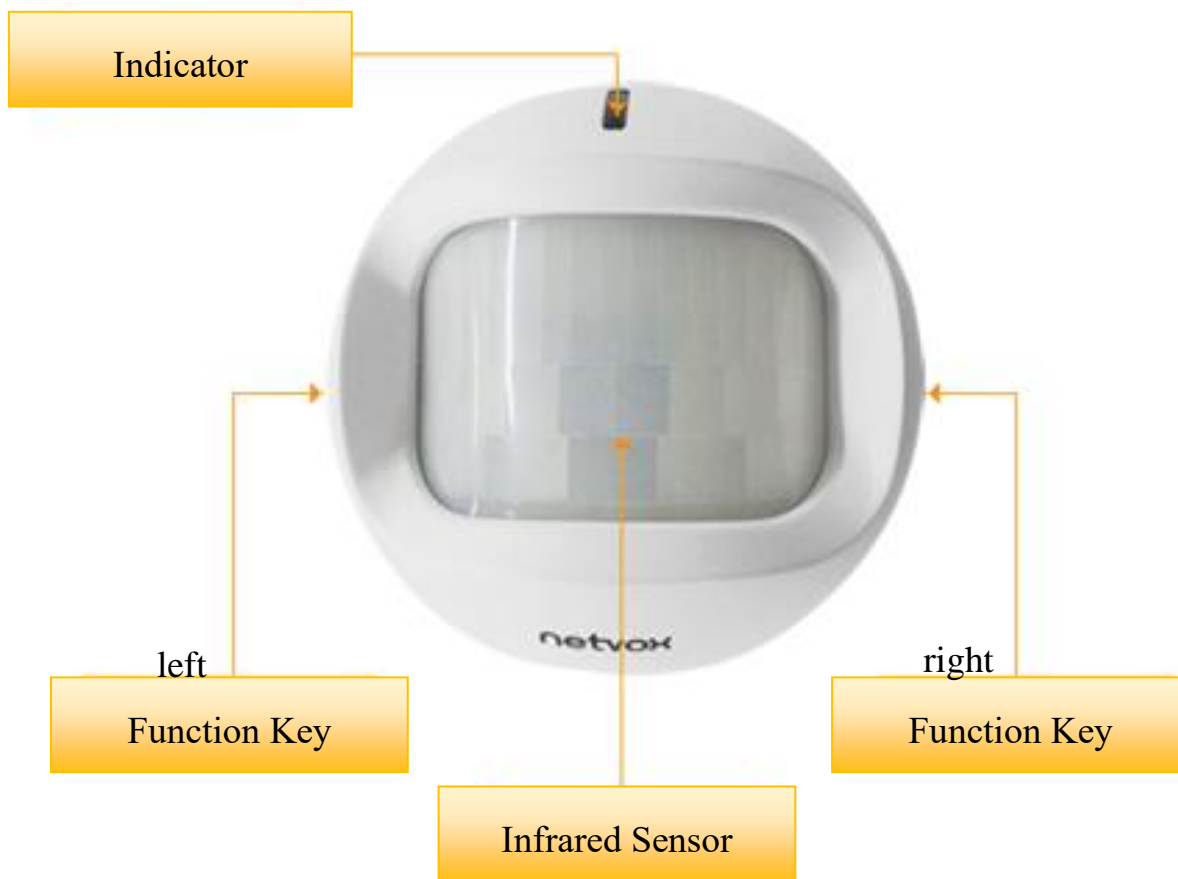

* RB11E is not equipped with the light adjustment knob.

3. Main Features

- Apply SX1276 wireless communication module
- 2 section of ER14505 battery in parallel (AA size 3.6V / section)
- Protection class: IP30
- PIR detection
- Temperature detection
- Illuminance detection
- Disassembled Alarm
- Compatible with LoRaWAN™ Class A
- Frequency hopping spread spectrum
- Configuration parameters can be configured via a third-party software platform, data can be read and alerts can be set via SMS text and email (optional)
- Applicable to third-party platforms: Actility/ThingPark, TTN, MyDevices/Cayenne

Improved power management for longer battery life

Battery Life:

- Please refer to web: http://www.netvox.com.tw/electric/electric_calc.html
- At this website, users can find battery life time for variety models at different configurations.
 1. Actual range may vary depending on environment.
 2. Battery life is determined by sensor reporting frequency and other variables.

4. Set up Instruction

On/Off

Power on	<p>Insert batteries.</p> <p>Operation method: Press and hold the snap-fit joint to open the upper and lower lids along the gap between the upper and lower covers. After opening the case, insert two pcs ER14505 3.6V AA into the battery compartment, and close the upper and lower covers.</p>
Turn on	Press <u>left function key</u> till the green and red indicator flash once and then release.
Turn off (Restore to factory setting)	Press and hold two function keys for 5 seconds till the green indicator flashes 20 times and enters off mode.
Power off	Remove Batteries.
Note:	On/off interval is suggested to be about 10 seconds to avoid the interference of capacitor inductance and other energy storage components.

Network Joining

Never join the network	<p>Turn on the device to search the network to join.</p> <p>The green indicator stays on for 5 seconds: success</p> <p>The green indicator remains off: fail</p>
Had joined the network	<p>Turn on the device to search the previous network to join.</p> <p>The green indicator stays on for 5 seconds: success</p> <p>The green indicator remains off: fail</p>

Function Key

Press and hold 2 Function Keys for 5 seconds	<p>Restore to factory setting / Turn off</p> <p>The green indicator flashes for 20 times: success</p> <p>The green indicator remains off: fail</p>
Press any Function Key once	<p>The device is in the network: the green indicator flashes once and sends a report</p> <p>The device is not in the network: green indicator remains off</p>

Sleeping Mode

The device is on and in the network	<p>Sleeping period: Min Interval.</p> <p>When the reportchange exceeds setting value or the state changes: send a data report according to Min Interval.</p>
-------------------------------------	--

Low Voltage Warning

Low Voltage	3.2 V
-------------	-------

5. Data Report

The device will immediately send a version packet report along with an uplink packet including temperature, illuminance, Occupy status, disassembled alarm and battery voltage.

The device sends data in the default configuration before any configuration is done.

Default setting:

MaxTime : Max Interval = 60 min = 3600s

MinTime : Min Interval = 60 min = 3600s

(According to the default, the device detects current voltage once every Min Interval.)

BatteryChange: 0x01 (0.1V)

TemperatureChange:0x0064 (1°C)

IlluminanceChange:0x0064 (100 Lux)

IRDisableTime:0x001E (30s) , IRDisableTime must \geq 5 seconds

IRDetectionTime:0x012C(300s) , IRDetectionTime must \geq IRDisableTime

Occupy status detection:

After the RB11E device detects the infrared, the red LED blinks once, and immediately reports an uplink packet.

Un-occupy = 0

Occupy = 1

Disassembled Alarm:

When the RB11E case is removed, the device will report an alarm

Assembled = 0

Disassembled= 1

Note:

The device report interval will be programmed based on the default firmware which may vary.

The interval between two reports must be the minimum time.

Please refer Netvox *LoRaWAN Application Command document* and *Netvox Lora Command Resolver*

<http://www.netvox.com.cn:8888/page/index> to resolve uplink data.

Data report configuration and sending period are as following:

Min Interval (Unit:second)	Max Interval (Unit:second)	Reportable Change	Current Change \geq Reportable Change	Current Change < Reportable Change
Any number between 1~65535	Any number between 1~65535	Can not be 0.	Report per Min Interval	Report per Max Interval

5.1 Example of ReportDataCmd

FPort: 0x06

Bytes	1	1	1	Var(Fix=8 Bytes)
	Version	DeviceType	ReportType	NetvoxPayloadData

Version– 1 byte –0x01—the Version of NetvoxLoRaWAN Application Command Version

DeviceType– 1 byte – Device Type of Device

The devicetype is listed in Netvox LoRaWAN Application Devicetype doc

ReportType – 1 byte –the presentation of the NetvoxPayloadData, according the devicetype

NetvoxPayloadData– Fixed bytes (Fixed =8bytes)

Device	Device Type	Report Type	NetvoxPayloadData					
RB11E	0x03	0x01	Battery (1Byte, unit:0.1V)	Temperature (Signed 2Bytes, unit:0.01°C)	illuminance (2Bytes, unit:1Lux)	Occupy (1Byte 0:Un Occupy 1: Occupy)	Disassembled Alarm (1Byte 0:Noalarm 1: Alarm)	Reserved (1Byte, fixed 0x00)

Example of Uplink:010301220A2800B4010000

1st byte (01): Version

2nd byte (03): DeviceType 0x03 — RB11E

3rd byte (01): ReportType

4th byte (22): Battery — 22(HEX)=34(DEC),34*0.1v=3.4v

5th 6th byte (0A28): Temperature — 0A28(HEX)=2600(DEC),2600*0.01 °C=26.00 °C

7th 8th byte (00B4): illuminance — 00B4(HEX)=180(DEC),180*1Lux=180Lux

9th byte (01): Occupy

10th byte (00): Disassembled Alarm — no alarm

11th byte (00): Reserved

5.2 Example of Report configuration

FPort: 0x07

Bytes	1	1	Var(Fix =9 Bytes)
	CmdID	DeviceType	NetvoxPayloadData

CmdID– 1 byte

DeviceType– 1 byte – Device Type of Device

NetvoxPayloadData– var bytes (Max=9bytes)

Description	Device	Cmd ID	Device Type	NetvoxPayLoadData					
ConfigReportReq	RB11E	0x01	0x03	MinTime (2bytes Unit:s)	MaxTime (2bytes Unit:s)	BatteryChange (1byte Unit:0.1v)	Temperature Change (2byte Unit:0.01°C)	Illuminance (2byte Unit: 1Lux)	
ConfigReportRsp		0x81		Status (0x00_success)		Reserved (8Bytes,Fixed 0x00)			
ReadConfig ReportReq		0x02		Reserved (9Bytes,Fixed 0x00)					
ReadConfig ReportRsp		0x82		MinTime (2bytes Unit:s)	MaxTime (2bytes Unit:s)	BatteryChange (1byte Unit:0.1v)	Temperature Change (2byte Unit:0.01°C)	Illuminance (2byte Unit: 1Lux)	
SetIRDisable TimeReq		0x03		IRDisableTime (2bytes Unit:s)		IRDetectionTime (2bytes Unit:s)		Reserved (5Bytes,Fixed 0x00)	
SetIRDisable TimeRsp		0x83		Status (0x00_success)		Reserved (8Bytes,Fixed 0x00)			
GetIRDisable TimeReq		0x04		Reserved (9Bytes,Fixed 0x00)					
GetIRDisable TimeRsp		0x84		IRDisableTime (2bytes Unit:s)		IRDetectionTime (2bytes Unit:s)		Reserved (5Bytes,Fixed 0x00)	

(1) Configure RB11E report parameters

MinTime = 1min, MaxTime = 1min, BatteryChange = 0.1v, TemperatureChange = 1°C, illuminance = 100 Lux

Downlink: 0103003C003C0100640064

Devices return:

81030000000000000000 (the configuration is successful)

81030100000000000000 (the configuration is failed)

(2) Read device configuration parameters

Downlink: 02030000000000000000

Devices return:

8203003C003C0100640064 (current device configuration parameters)

(3) Configure RB11E IR Delay parameters

IRDisableTime= 30s、IRDetectionTime= 30s (IRDetectionTime >= IRDisableTime)

Downlink: 0303001E001E0000000000

Devices return:

84030000000000000000 (the configuration is successful)

84030100000000000000 (the configuration is failed)

(4) Read RB11E IR Delay parameters

Downlink: 040300000000000000000000

Devices return:

8403001E001E0000000000 (current device configuration parameters)

5.3 Example for MinTime/MaxTime logic

Example#1 based on MinTime = 1 Hour, MaxTime= 1 Hour, Reportable Change i.e. BatteryVoltageChange=0.1V

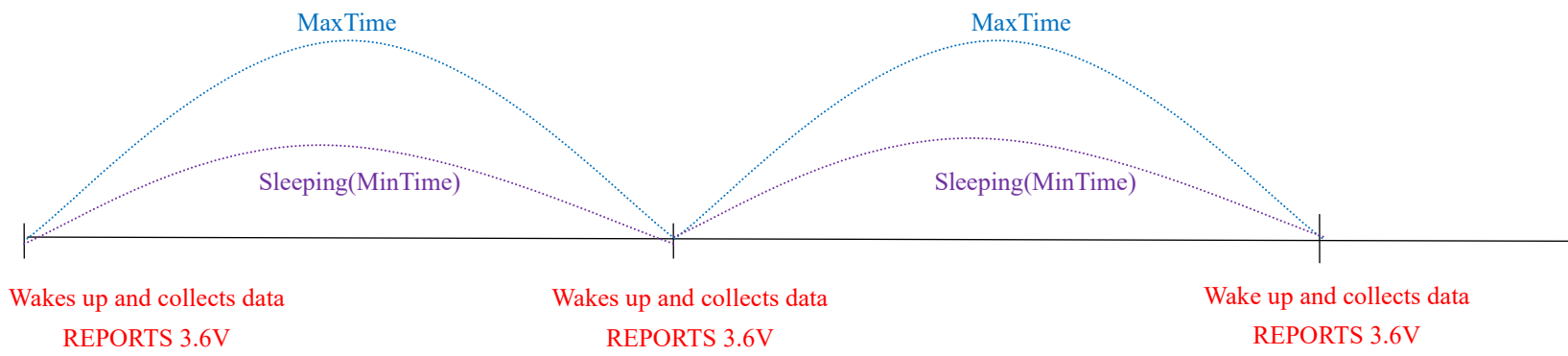

Note: MaxTime=MinTime. Data will only be report according to MaxTime (MinTime) duration regardless BatteryVoltageChange value.

Example#2 based on MinTime = 15 Minutes, MaxTime= 1 Hour, Reportable Change i.e. BatteryVoltageChange= 0.1V.

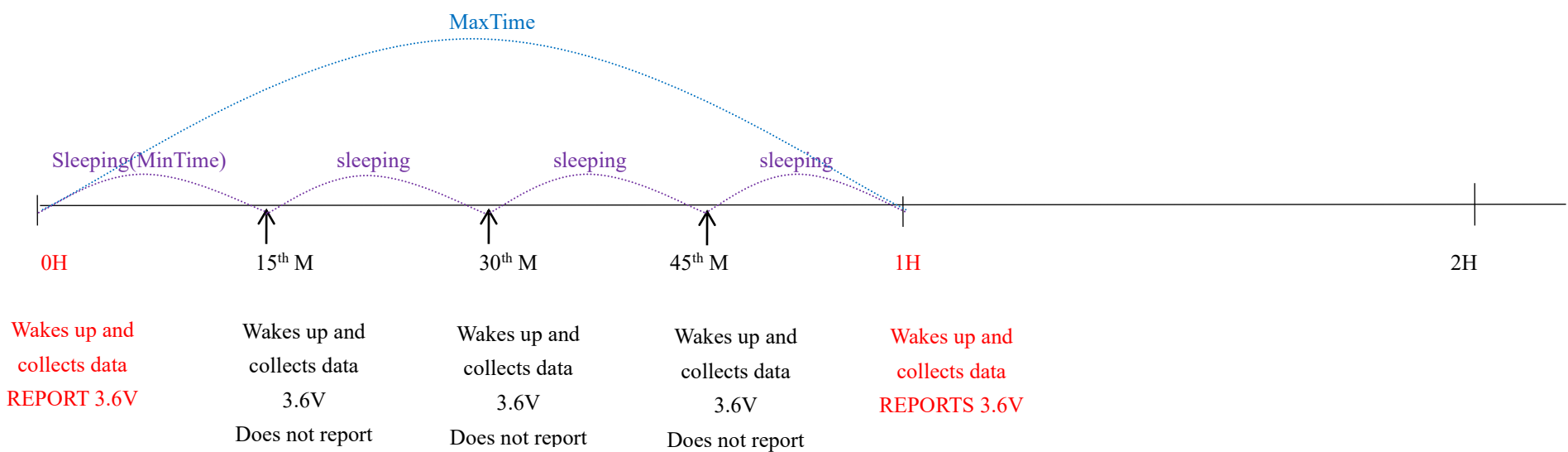

Example#3 based on MinTime = 15 Minutes, MaxTime= 1 Hour, Reportable Change i.e. BatteryVoltageChange= 0.1V.

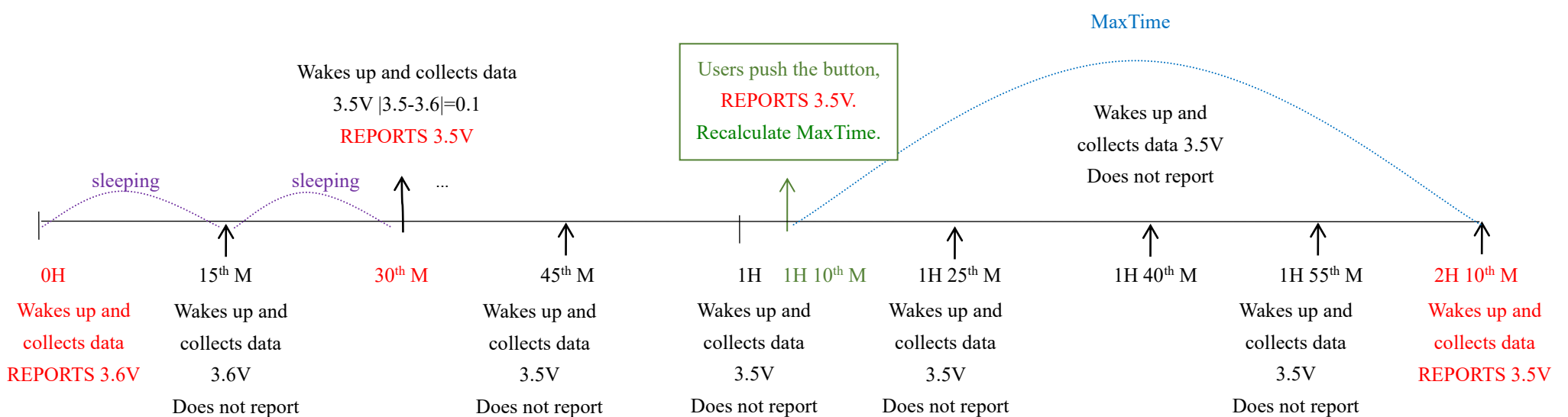

Notes:

- 1) The device only wakes up and performs data sampling according to MinTime Interval. When it is sleeping, it does not collect data.
- 2) The data collected is compared with the last data reported. If the data variation is greater than the ReportableChange value, the device reports according to MinTime interval. If the data variation is not greater than the last data reported, the device reports according to MaxTime interval.
- 3) We do not recommend to set the MinTime Interval value too low. If the MinTime Interval is too low, the device wakes up frequently and the battery will be drained soon.
- 4) Whenever the device sends a report, no matter resulting from data variation, button pushed or MaxTime interval, another cycle of MinTime/MaxTime calculation is started.

6. IR Delay Configuration

If someone or animal is moving in the monitoring area, RB11E will detect the infrared signal and the red indicator will flash once. In the meantime, it reports occupied status (at the same time, other sensor status value is also reported).

To save the power, when RB11E detects the infrared signal, it will enter IRDetectionTime period. If there is no infrared signal detected in IRDetectionTime period. It will report un-occupy.

IRDisableTime is the sampling period during IRDetectionTime (IRDisableTime are 30 seconds by default setting that PIR is off for first 70% of the period; on for rest 30% of the period).

For example, after triggered, the PIR will turn off the infrared probe for 21 ($30 * 70\%$) seconds to save the power, living objects within this period will not be detected. PIR will re-open detection function after 21 seconds, if it detects living objects in this period, the IR delay time will be extended for another 30 seconds till no infrared signal is detected and IRDetectionTime period is due and RB11E will then report un-occupy.

The infrared sensitivity adjustment knob can be manually adjusted to change the sensitivity of the infrared detection. When the clockwise rotation, the higher the infrared sensitivity, the easier it is to trigger.

Disabletime and Detectiontime

IRDisableTime is the sampling period, and IRDetectionTime is the detecting period.

To save power, the sensor will be in the sleep mode for the first 70% of the IRDisableTime and awaken for the last 30% of the IRDisableTime.

- If living creature is detected during the last 30% of IRDisableTime, the IR delay time will be extended for another IRDetectionTime till no infrared signal is detected.
- If no living creature is detected during IRDetectionTime, RB11E will report “unoccupied” along with other sensor status, such as temperature, illuminance, etc.

Example1:

The IRDetectionTime is 60 seconds and the IRDisableTime is 30 seconds, no living creature is detected during the two 9-second detection period (the yellow parts shown below).

RB11E will report “unoccupied” after 60 seconds (IRDetectTime).

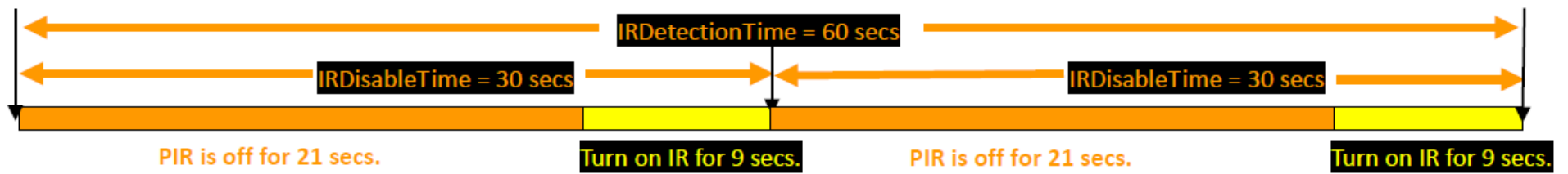

Example2:

The IRDetectionTime is 60 seconds and IRDisableTime is 30 seconds, living creature is detected at the 25th second of the first 30 seconds.

RB11E will restart the IR detecting procedure(IRDetectionTime).

No living creature is detected during the next IRDetectionTime and RB11E therefore report “unoccupied.”



7. Installation

The applicable fixing method can be selected according to the installation environment.

1. Fix with the double-sided tape
2. Fix with the steel nail or screw
3. Fix with the double-sided tape first, and then fix with the screw

7.1 Tips for installing the double-sided stickers

1. Clean the surface of the objects you plan to use the sticker with.
2. Tear off 3M300LSE side of the sticker, place it to the bottom of the product as shown on the picture, and press it.
3. Tear off 3M9080A side of the sticker and put the sticker to a clean surface of the wall and press the sticker firmly for around 20 seconds.



Note:

1. The white release paper side (with gray letters 3M9080A) is for the wall.

The brown release paper side (with green letters 3M300LSE) is for the plastic base of the product.

2. Make sure there is no dust on the surface of the wall: wipe the dust and dirt off the wall.

3. Make sure the wall is not wet: it is recommended to use a dryer to dry the wall before putting the sticker.

7.2 Tips for installing the steel nails

1. Make sure there is no dust on the surface of the wall.

2. Separate the bottom of the product, as shown on picture 1.

3. Put the steel nails through the holes of the bottom part, place the bottom with the nails on where you want to install the device on the wall, and drive the nails into the wall. Leave 2mm of the nails from the surface of the bottom part, as shown on picture 2.

4. Fasten the rest of the device to the bottom, as shown on picture 3.



Picture 1



Picture 2



Picture 3

Note:

The steel nails are only for brick walls, cement walls, woods, etc.

They are not for concrete, as concrete is too hard for the nails.

Screw dimension:

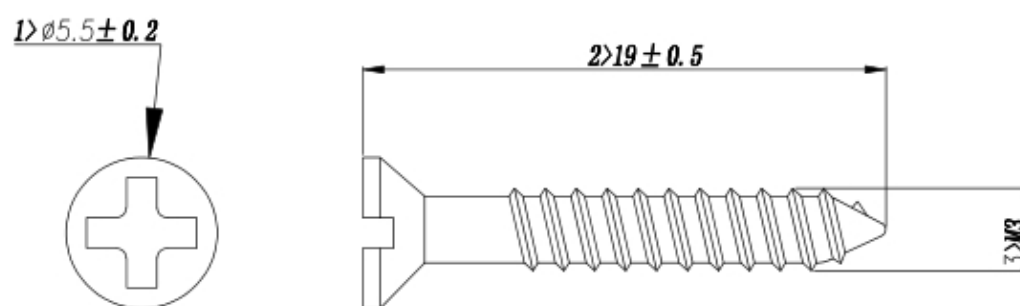

Steel nails dimension:

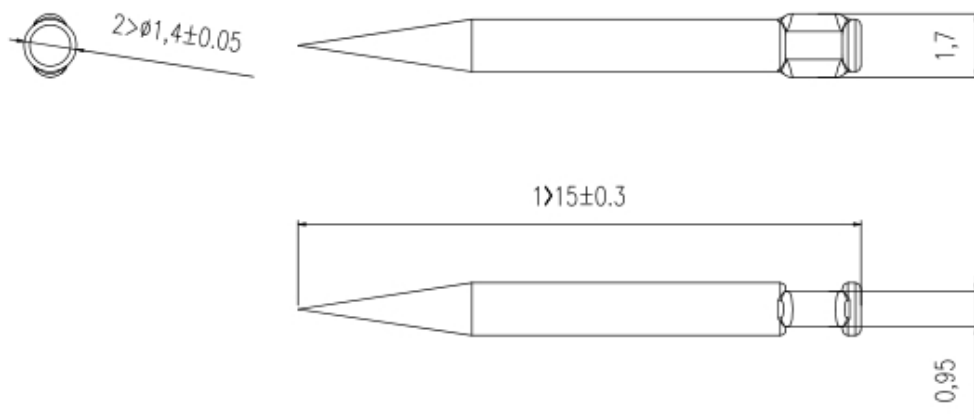

7.3 Installation battery steps

The device must use 2 sections of ER14505 battery (3.6v/section)

*CAUTION Risk of fire or explosion if the battery is replaced by an incorrect type

* Please do not insert the battery reversely.

Step1

Press and hold the [Snap-fit joint], and separate the upper lid and lower cover.



Step2

Put the batteries into the battery bay of the device and note the positive and negative poles of the battery, please do not insert the battery reversely.

Attention!
3.6 v AA
Battery only

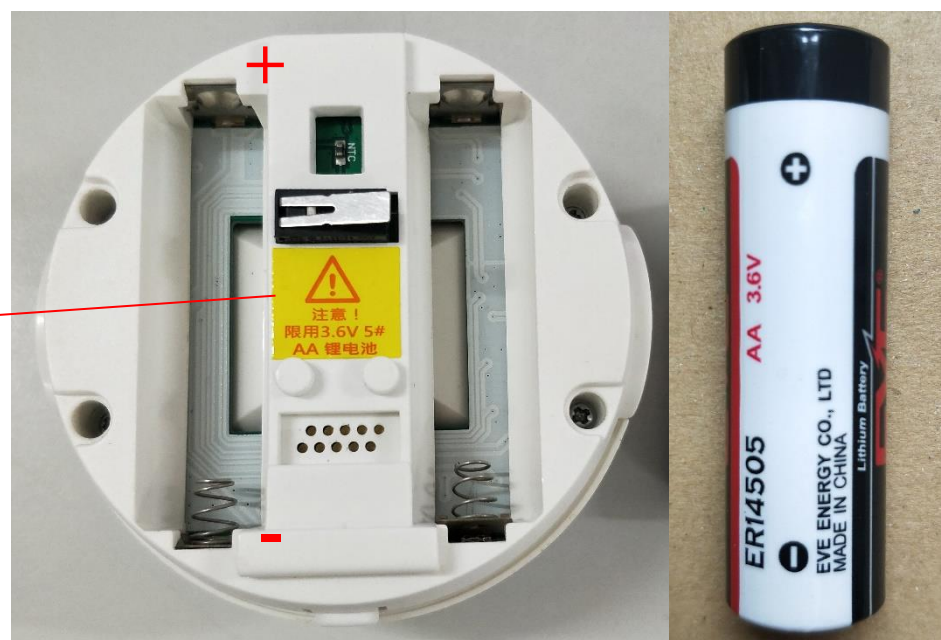

Step3

After inserting the batteries, as the following picture, align the position of the hole first, and then assemble the upper and lower covers



7.4 Installation requirements

Installation ambient temperature: $-20^{\circ}\text{C} \sim 55^{\circ}\text{C}$

1. Indoor use only, please check the installation places. The correct installation should follow below conditions.

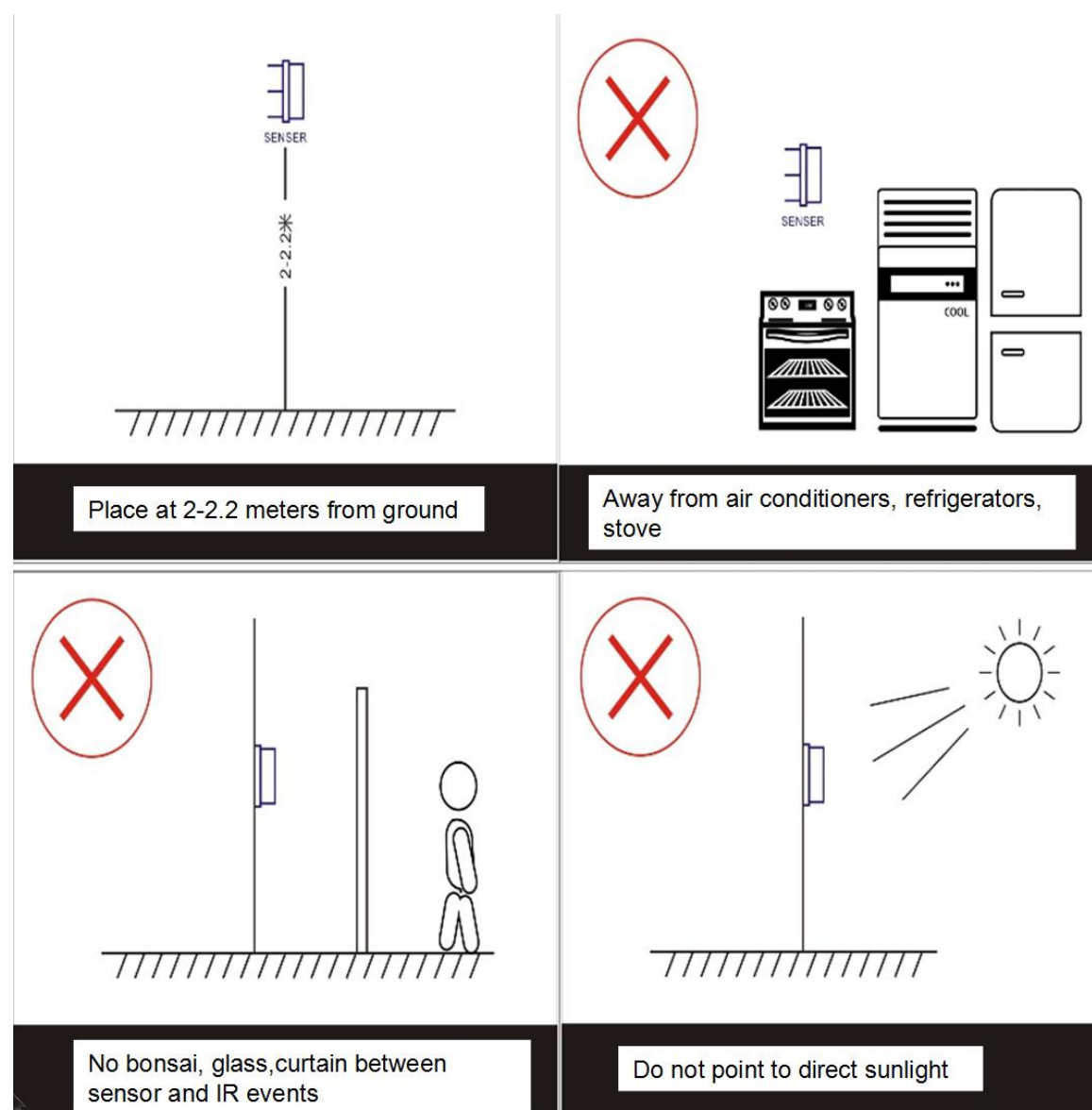

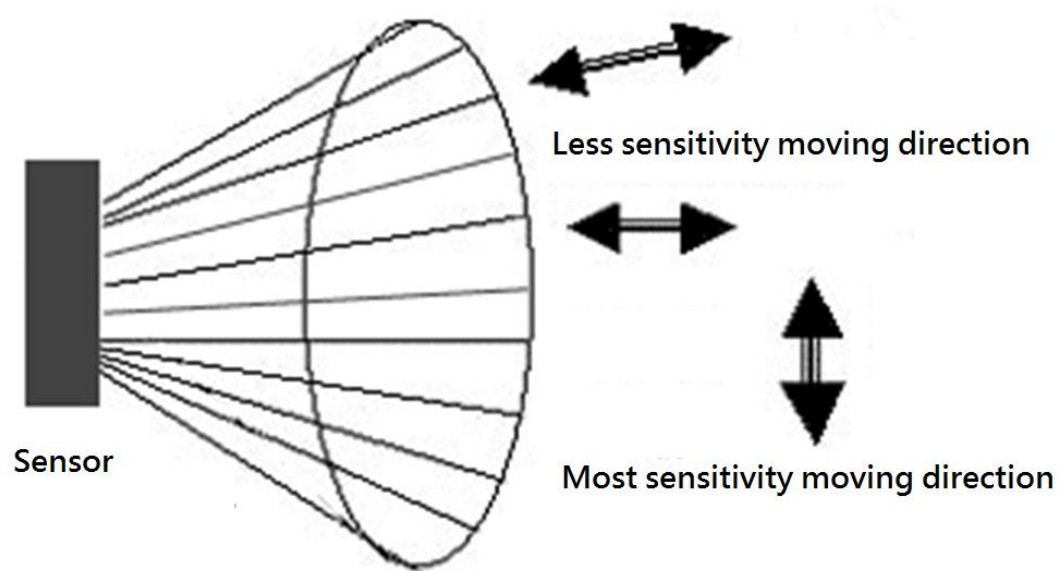
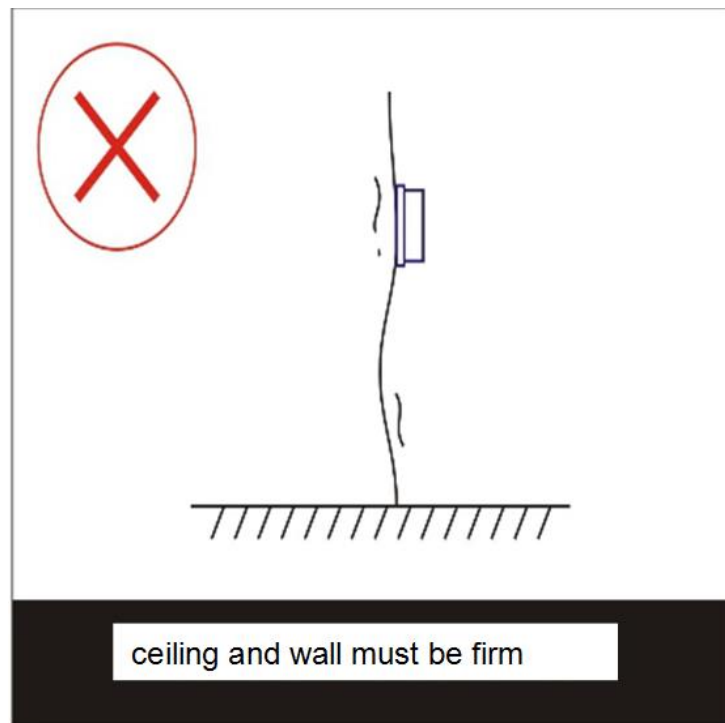

The sensitivity of the PIR sensor has a lot to do with the motion direction of the human body. The PIR sensor is more sensitive to vertical motions, while it is less sensitive to horizontal motions. Thus, it is important to choose the proper location for installation and higher sensitivity.

7.5 Detection coverage

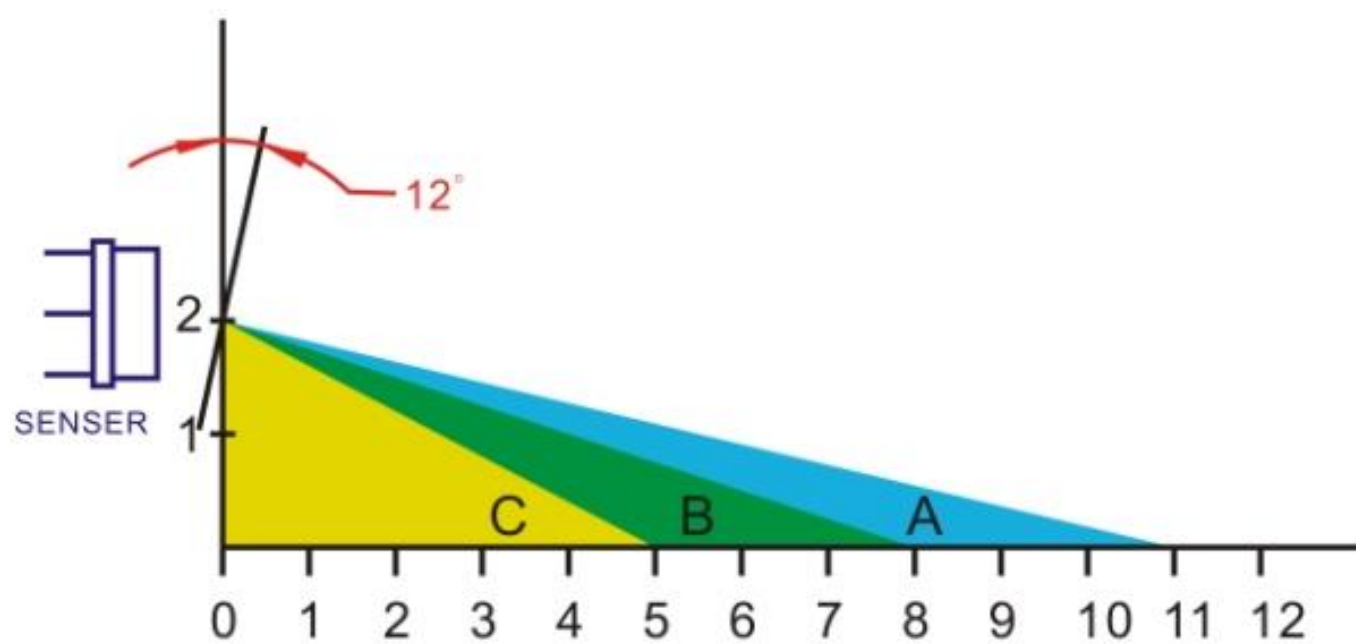

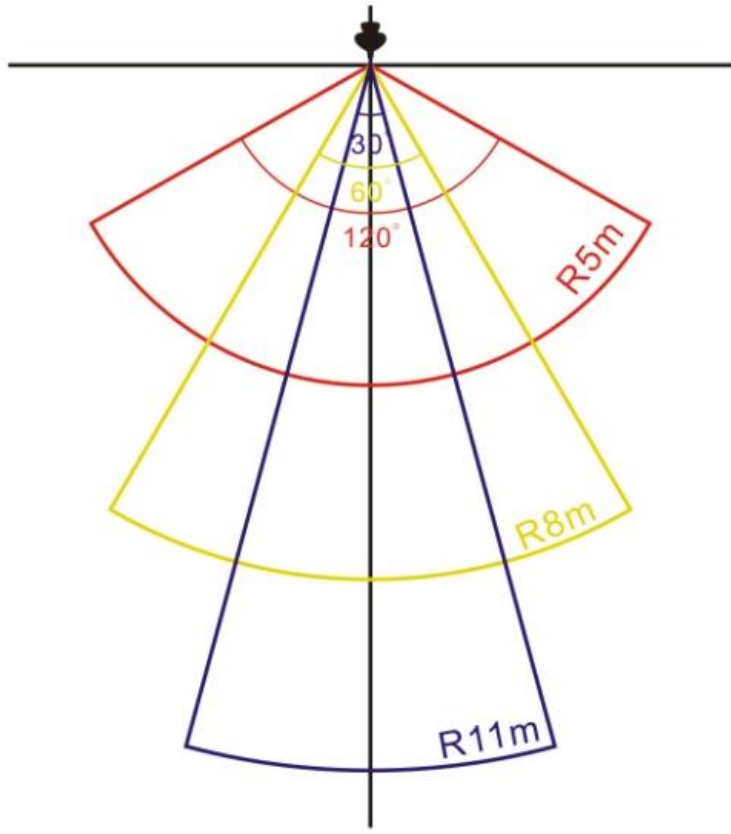

Horizontal projected area

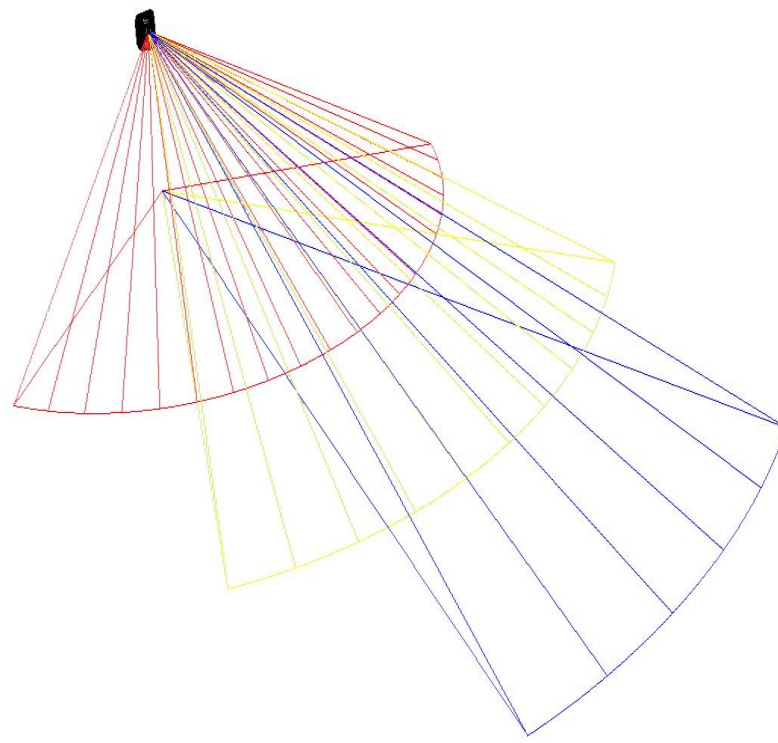

Space projected area

IR coverage range:

The coverage area A- Distance: 11 meters; sensing angle: 30°

The coverage area B- Distance: 8 meters; sensing angle: 60°

The coverage area C- Distance: 5 meters; sensing angle: 120°

8. Information about Battery Passivation

Many of Netvox devices are powered by 3.6V ER14505 Li-SOCl₂ (lithium-thionyl chloride) batteries that offer many advantages including low self-discharge rate and high energy density.

However, primary lithium batteries like Li-SOCl₂ batteries will form a passivation layer as a reaction between the lithium anode and thionyl chloride if they are in storage for a long time or if the storage temperature is too high. This lithium chloride layer prevents rapid self-discharge caused by continuous reaction between lithium and thionyl chloride, but battery passivation may also lead to voltage delay when the batteries are put into operation, and our devices may not work correctly in this situation.

As a result, please make sure to source batteries from reliable vendors, and it is suggested that if the storage period is more than one month from the date of battery production, all the batteries should be activated.

If encountering the situation of battery passivation, users can activate the battery to eliminate the battery hysteresis.

ER14505 Battery Passivation:

8.1 To determine whether a battery requires activation

Connect a new ER14505 battery to a resistor in parallel, and check the voltage of the circuit.

If the voltage is below 3.3V, it means the battery requires activation.

8.2 How to activate the battery

- a. Connect a battery to a resistor in parallel
- b. Keep the connection for 5~8 minutes
- c. The voltage of the circuit should be ≥ 3.3 , indicating successful activation.

Brand	Load Resistance	Activation Time	Activation Current
NHTONE	165 Ω	5 minutes	20mA
RAMWAY	67 Ω	8 minutes	50mA
EVE	67 Ω	8 minutes	50mA
SAFT	67 Ω	8 minutes	50mA

Note:

If you buy batteries from other than the above four manufacturers, then the battery activation time, activation current, and required load resistance shall be mainly subject to the announcement of each manufacturer.

9. Important Maintenance Instruction

Kindly pay attention to the following in order to achieve the best maintenance of the product:

- Keep the device dry. Rain, moisture, or any liquid might contain minerals and thus corrode electronic circuits. If the device gets wet, please dry it completely.
- Do not use or store the device in dusty or dirty environment. It might damage its detachable parts and electronic components.
- Do not store the device under excessive heat condition. High temperature can shorten the life of electronic devices, destroy batteries, and deform or melt some plastic parts.
- Do not store the device in places that are too cold. Otherwise, when the temperature rises to normal temperature, moisture will form inside, which will destroy the board.
- Do not throw, knock or shake the device. Rough handling of equipment can destroy internal circuit boards and delicate structures.
- Do not clean the device with strong chemicals, detergents or strong detergents.
- Do not apply the device with paint. Smudges might block in the device and affect the operation.
- Do not throw the battery into the fire, or the battery will explode. Damaged batteries may also explode.

All of the above applies to your device, battery and accessories. If any device is not working properly, please take it to the nearest authorized service facility for repair.