



SENSECAP

SenseCAP LoRaWAN Sensor User Manual

Version: V1.1

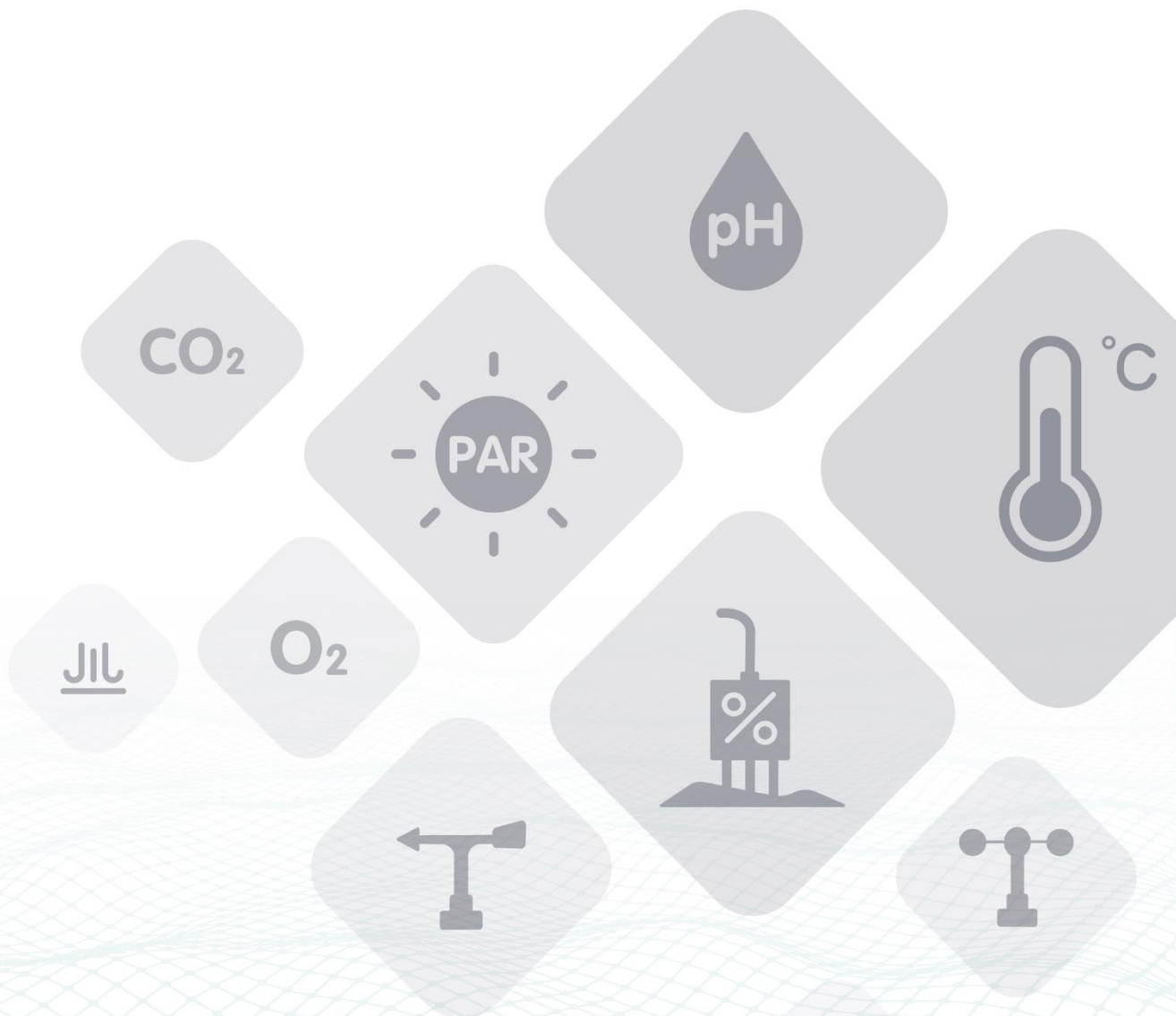

Table of Contents

1	Product Introduction.....	3
2	Key Parameters of the Sensor Node.....	5
2.1	Introduction of Key Parameters	5
2.2	Get Device EUI, App EUI and Key.....	5
3	Connect to Gateway and Servers.....	7
3.1	Configuration Overview.....	7
3.2	Connect to the SenseCAP Gateway (Recommend Product).....	9
3.3	Connect to a Standard LoRaWAN Gateway.....	11
3.3.1	Power On	11
3.3.2	Sensor Node Working Status.....	12
3.3.3	Connect to the Gateway (LPS8) and TTN Server	12
4	How to Modify the Key Parameters	20
4.1	Preparation.....	20
4.2	Modify the Device EUI, App EUI & Key and Data Interval.....	22
4.3	Modify the Sub-band.....	24
4.4	Modify the Data Interval Remotely.....	25
5	Decoding	26
5.1	Packet Parsing.....	27
5.1.1	Example 1 - Air Temperature & Humidity Sensor:	27
5.1.2	Example 2 - CO2 Sensor:	28
5.1.3	Example 3 - Soil Moisture and Temperature Sensor:	29
5.1.4	Example 4 – Light Intensity Sensor:	30
5.1.5	Example 5 – Barometric Pressure Sensor:.....	30
5.2	Battery Information.....	33
6	Device Installation.....	35
6.1	Installing Sensor Node.....	35
6.1.1	Installing the Sensor Node Bracket	35
6.1.2	Installing Sensor Nodes	36
6.1.3	Dos and Don'ts in Installing Sensor Probes	37
7	Trouble Shooting.....	38
7.1	Sensor Node not join the network, how to do?.....	38
7.2	Why is the new sensor's battery not 100%?.....	38
7.3	Why can't I get into configuration mode with the USB to TTL serial tool?.....	38
7.4	Support.....	38

1 Product Introduction



SenseCAP is an industrial wireless sensor network that integrates easy-to-deploy hardware and data API services, enabling low-power, long-distance environmental data collection.

SenseCAP LoRaWAN products include LoRaWAN Gateways and Sensor Nodes. Based on the LoRaWAN protocol, it can realize one-to-many, long-distance networking and bilateral communication. The LoRaWAN Gateway supports Ethernet and 4G. The Sensor Node is powered by a high-capacity battery that lasts up to 3 years (if uploading data once every hour). It also supports hot-swap, making it easy for maintenance and upgrading.

It is recommended that you use the SenseCAP LoRaWAN Gateway. You can have out-of-the-box experiences without complex operations. We also provide the SenseCAP Portal, where you can view the data and manage the device when the device is powered on, and you can use the API for integrated development. SenseCAP LoRaWAN Gateway can use SenseCAP Server, The Things Network Server, and Chirp Stack Server to build your applications.

SenseCAP LoRaWAN Sensor Nodes can work with third-party standard LoRaWAN gateways. For users who already have an existing LoRaWAN gateway, please kindly refer to this tutorial about connecting SenseCAP Sensor Nodes with your gateway.



Sensor Node Controller

- LoRa Communication module
- Ultra-low power microcontroller
- Battery

Sensor Probe

- Hot swap connector
- Different sensor probe
- Replaceable

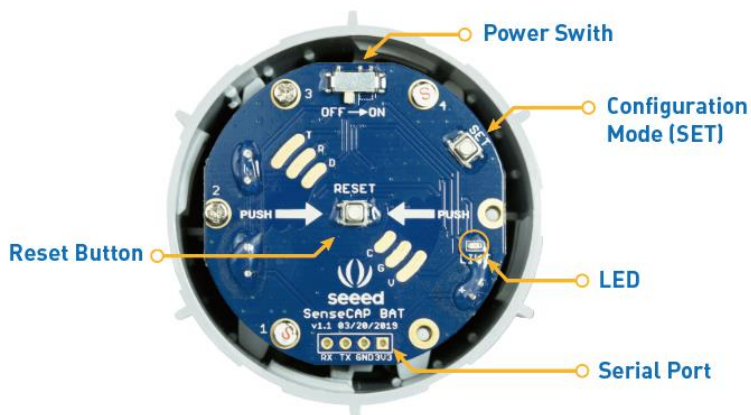

Sensor Node Controller



Sensor Probe

Seed Tech

2 Key Parameters of the Sensor Node

2.1 Introduction of Key Parameters

Using the LoRaWAN protocol generally involves the following parameters.

Parameters	Description
Device EUI	Unique identification of device, one of the network join parameters.
Device Code	For device binding and API call.
App EUI	Unique identification of application, one of the network join parameters.
App Key	Application key, one of the network join parameters.

2.2 Get Device EUI, App EUI and Key

(1) Device EUI and Device Code is on the SenseCAP product label.

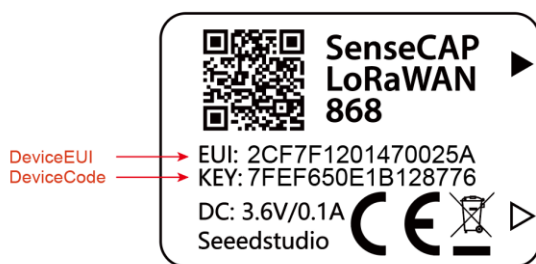

Tips: Device Code is not the App Key!

(2) SenseCAP Sensor Node's App EUI and App Key have been flashed into the device by Seed. Use HTTP API to get App EUI and App Key. You can use a browser to issue an HTTP GET request.

Curl:

```
https://sensecap.seeed.cc/makerapi/device/view_device_info?nodeEui=2CF7F12014700297&deviceCode=34BF25920A4EFBF4
```

In the API, replace the Device EUI and device Code with your own Device EUI and Device Code respectively. And you will get the following response:

dev_eui	Device EUI
app_eui	App EUI
app_key	App Key

```
{
  "code": "0",
  "data": {
    "nodeEui": "2CF7F12014700297",
    "deviceCode": "34BF25920A4EFBF4",
    "lorawanInformation": {
      "dev_eui": "2CF7F12014700297",
      "app_eui": "8000000000000006",
      "app_key": "6FD0EF47CBC6E00F1921A08C2E94E8E5"
    }
  },
  "time": 0.019
}
```

Tips: The SenseCAP LoRaWAN Sensor can modify to EUI and Key. Please refer to the following sections.

3 Connect to Gateway and Servers.

3.1 Configuration Overview

Device Parameters	
LoRaWAN MAC version	1.0.2
LoRaWAN Regional Parameters revision	B
Join Type	OTAA
Device EUI	Refer to section 2 for details.
App EUI	Refer to section 2 for details.
App Key	Refer to section 2 for details.

Frequency Plans																																																																										
EU868 (LoRa-S-868- XXX-XX)	Uplink: 868.1 - SF7BW125 to SF12BW125 868.3 - SF7BW125 to SF12BW125 and SF7BW250 868.5 - SF7BW125 to SF12BW125 867.1 - SF7BW125 to SF12BW125 867.3 - SF7BW125 to SF12BW125 867.5 - SF7BW125 to SF12BW125 867.7 - SF7BW125 to SF12BW125 867.9 - SF7BW125 to SF12BW125 868.8 – FSK Downlink: Uplink channels 1-9 (RX1) 869.525 - SF9BW125 (RX2 downlink only)																																																																									
US915 (LoRa-S-915- XXX-XX)	<table border="1" style="width: 100%; border-collapse: collapse; text-align: center;"> <tbody> <tr> <td>902.3</td><td>903.9</td><td>905.5</td><td>907.1</td><td>908.7</td><td>910.3</td><td>911.9</td><td>913.5</td><td rowspan="9" style="vertical-align: middle;">125kHz DR0 to DR3</td> </tr> <tr> <td>902.5</td><td>904.1</td><td>905.7</td><td>907.3</td><td>908.9</td><td>910.5</td><td>912.1</td><td>913.7</td> </tr> <tr> <td>902.7</td><td>904.3</td><td>905.9</td><td>907.5</td><td>909.1</td><td>910.7</td><td>912.3</td><td>913.9</td> </tr> <tr> <td>902.9</td><td>904.5</td><td>906.1</td><td>907.7</td><td>909.3</td><td>910.9</td><td>912.5</td><td>914.1</td> </tr> <tr> <td>903.1</td><td>904.7</td><td>906.3</td><td>907.9</td><td>909.5</td><td>911.1</td><td>912.7</td><td>914.3</td> </tr> <tr> <td>903.3</td><td>904.9</td><td>906.5</td><td>908.1</td><td>909.7</td><td>911.3</td><td>912.9</td><td>914.5</td> </tr> <tr> <td>903.5</td><td>905.1</td><td>906.7</td><td>908.3</td><td>909.9</td><td>911.5</td><td>913.1</td><td>914.7</td> </tr> <tr> <td>903.7</td><td>905.3</td><td>906.9</td><td>908.5</td><td>910.1</td><td>911.7</td><td>913.3</td><td>914.9</td> </tr> <tr> <td>Channel 0 to 7</td><td>Channel 8 to 15</td><td>Channel 16 to 23</td><td>Channel 24 to 31</td><td>Channel 32 to 39</td><td>Channel 40 to 47</td><td>Channel 48 to 55</td><td>Channel 56 to 63</td> </tr> </tbody> </table>	902.3	903.9	905.5	907.1	908.7	910.3	911.9	913.5	125kHz DR0 to DR3	902.5	904.1	905.7	907.3	908.9	910.5	912.1	913.7	902.7	904.3	905.9	907.5	909.1	910.7	912.3	913.9	902.9	904.5	906.1	907.7	909.3	910.9	912.5	914.1	903.1	904.7	906.3	907.9	909.5	911.1	912.7	914.3	903.3	904.9	906.5	908.1	909.7	911.3	912.9	914.5	903.5	905.1	906.7	908.3	909.9	911.5	913.1	914.7	903.7	905.3	906.9	908.5	910.1	911.7	913.3	914.9	Channel 0 to 7	Channel 8 to 15	Channel 16 to 23	Channel 24 to 31	Channel 32 to 39	Channel 40 to 47	Channel 48 to 55	Channel 56 to 63
902.3	903.9	905.5	907.1	908.7	910.3	911.9	913.5	125kHz DR0 to DR3																																																																		
902.5	904.1	905.7	907.3	908.9	910.5	912.1	913.7																																																																			
902.7	904.3	905.9	907.5	909.1	910.7	912.3	913.9																																																																			
902.9	904.5	906.1	907.7	909.3	910.9	912.5	914.1																																																																			
903.1	904.7	906.3	907.9	909.5	911.1	912.7	914.3																																																																			
903.3	904.9	906.5	908.1	909.7	911.3	912.9	914.5																																																																			
903.5	905.1	906.7	908.3	909.9	911.5	913.1	914.7																																																																			
903.7	905.3	906.9	908.5	910.1	911.7	913.3	914.9																																																																			
Channel 0 to 7	Channel 8 to 15	Channel 16 to 23	Channel 24 to 31	Channel 32 to 39	Channel 40 to 47	Channel 48 to 55	Channel 56 to 63																																																																			

	903	904.6	906.2	907.8	909.4	911	912.6	914.2	Channel 64 to 71 500kHz DR4
	Sub-band 1	Sub-band 2	Sub-band 3	Sub-band 4	Sub-band 5	Sub-band 6	Sub-band 7	Sub-band 8	
<p>Default: Sub-band 2 (Channel 8 to 15)</p> <p>Downlink:</p> <p>923.3 - SF7BW500 to SF12BW500</p> <p>923.9 - SF7BW500 to SF12BW500</p> <p>924.5 - SF7BW500 to SF12BW500</p> <p>925.1 - SF7BW500 to SF12BW500</p> <p>925.7 - SF7BW500 to SF12BW500</p> <p>926.3 - SF7BW500 to SF12BW500</p> <p>926.9 - SF7BW500 to SF12BW500</p> <p>927.5 - SF7BW500 to SF12BW500</p>									

3.2 Connect to the SenseCAP Gateway (Recommend Product)

It only takes 4 steps to get started and install.

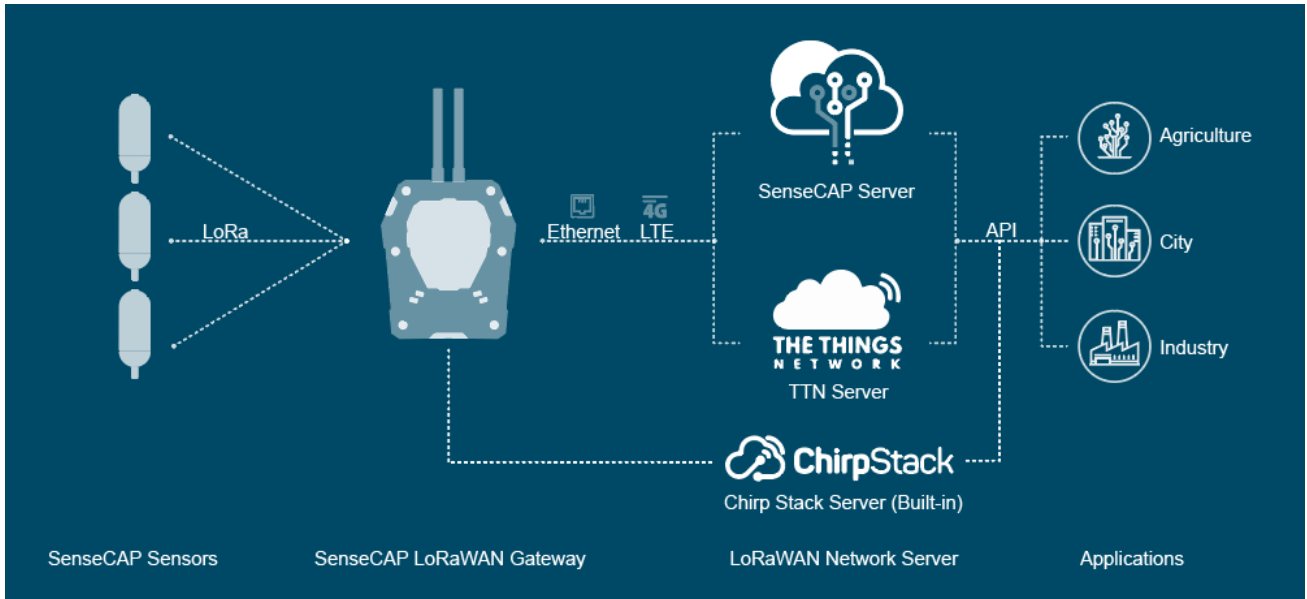

Step1: Scan code to bind the Gateway and Sensors.

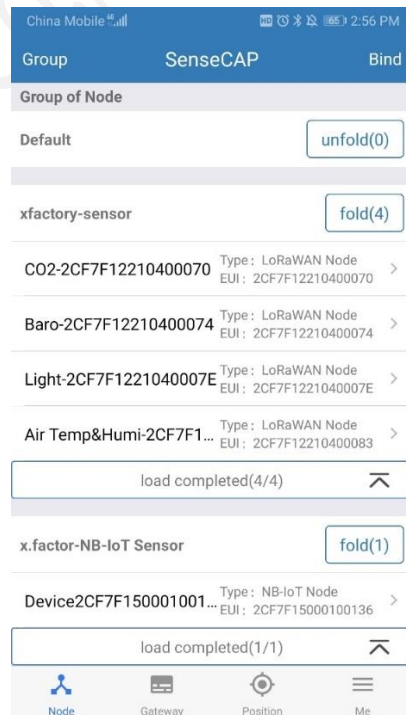

Step2: Turn on the Gateway and Sensors.

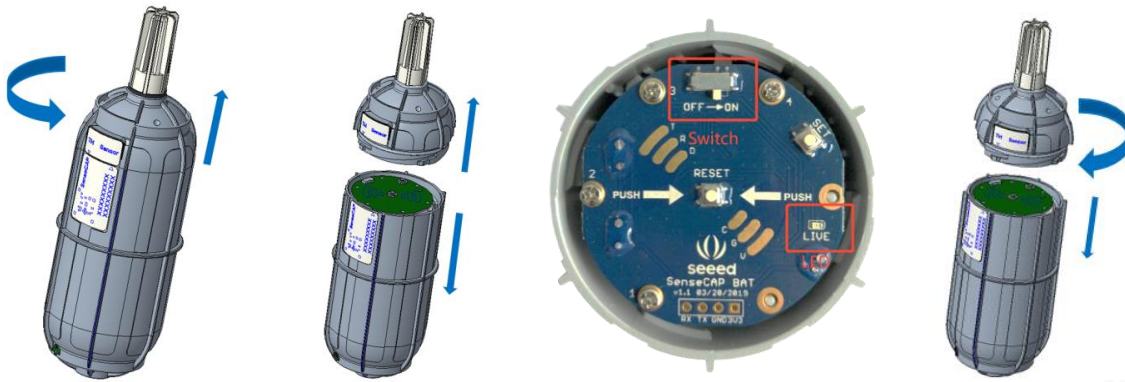

Step3: Log on to the SenseCAP Portal to view the data.

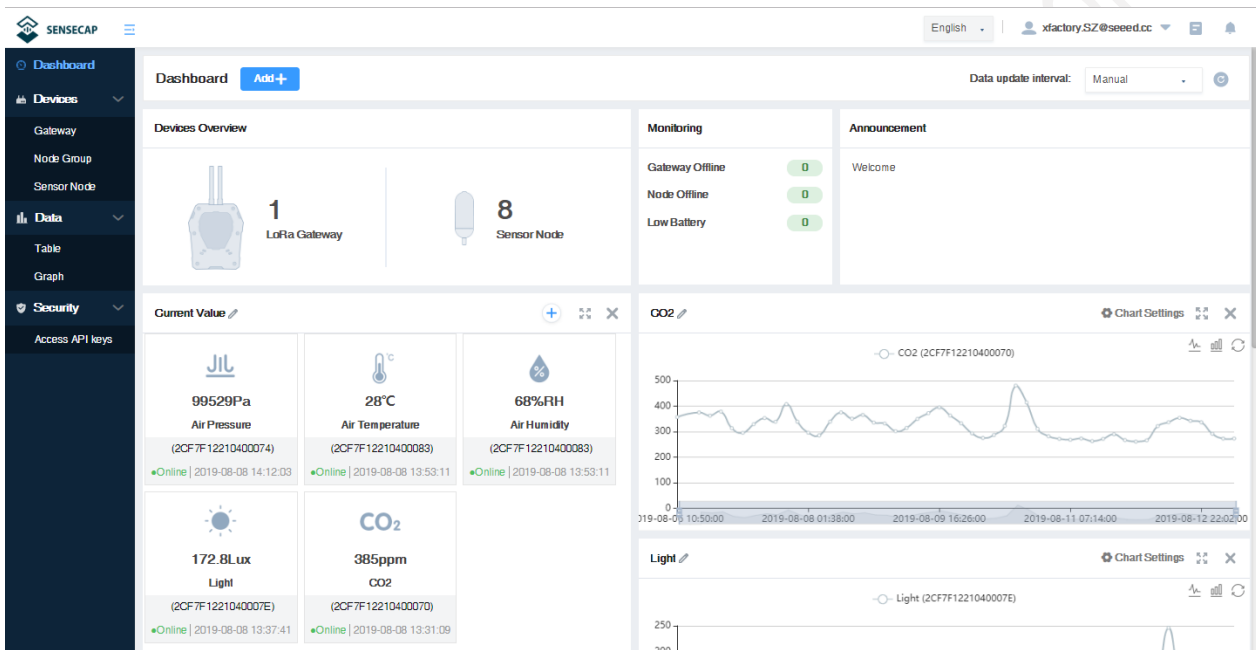

Step4: Install the gateway and sensors.

Refer to SenseCAP LoRaWAN Gateway for more details:

<https://www.seeedstudio.com/LoRaWAN-Gateway-EU868-p-4305.html>

3.3 Connect to a Standard LoRaWAN Gateway

SenseCAP Sensor Nodes support standard LoRaWAN 1.0.2 protocol, making it possible to connect to standard LoRaWAN gateways and servers.

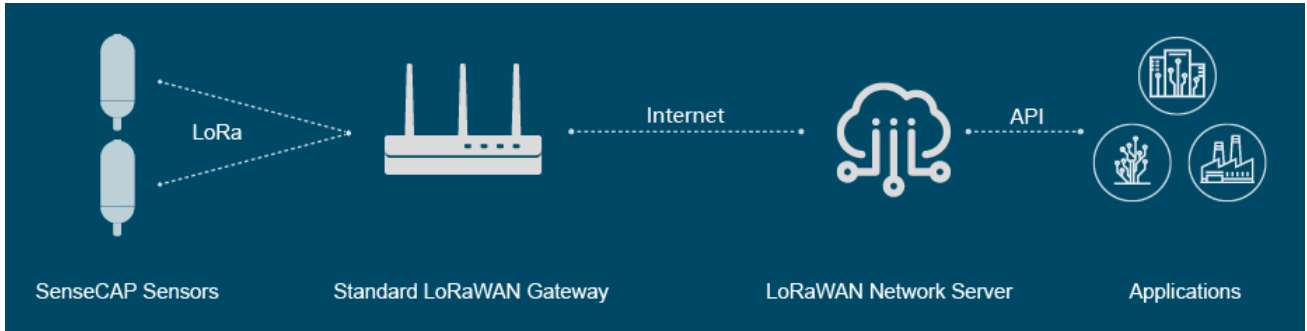

3.3.1 Power On

The power switch is hidden inside the device. Open the device and turn on the power before installing the sensors. Here is the step-by-step instruction:

- 1) Loosen the Sensor Probe by turning the cap counterclockwise. Use the white cap opener to make this process easier. The image below uses TH Sensor as an example and applies to all other SenseCAP sensors.

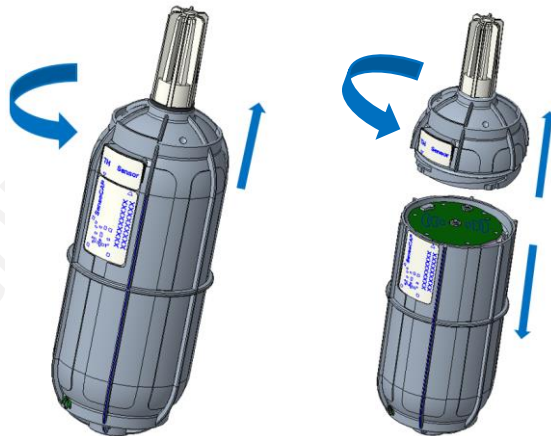

- 2) After opening the device, turn the switch to “ON”, and the LED on the lower right corner will flash, indicating that the power is on. Wait for about 10 seconds, then the LED will flash quickly for 2 seconds, indicating that the device is connected to the network.

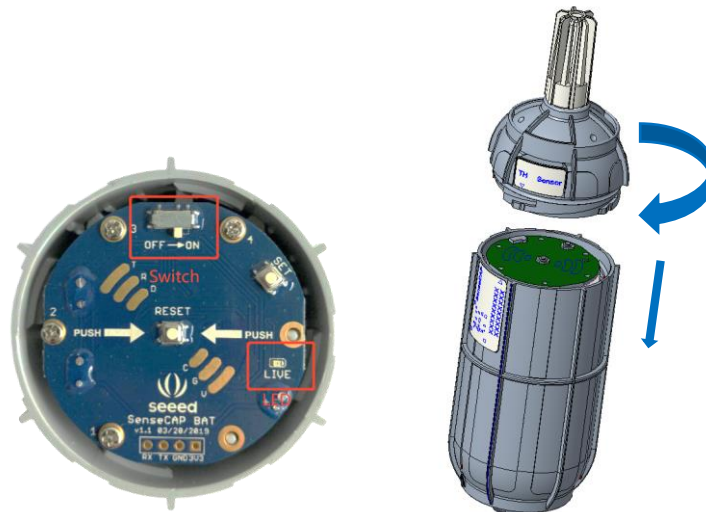

- 3) After the device is connected to the network, connect the Sensor Probe back with the Sensor Node Controller by turning it clockwise. Please note that the labels on both parts should be aligned as shown in the image below, otherwise the two parts will not be attached to function properly and data will not be uploaded.

3.3.2 Sensor Node Working Status

You can refer to the LED indicator for the Sensor Node for its working status. Please see the status explanations in the image below:

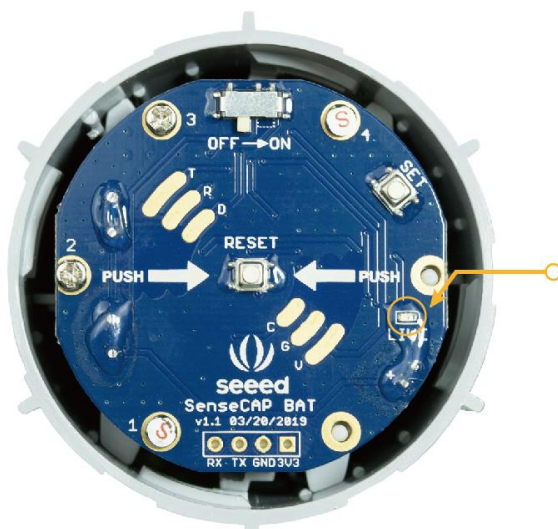

LED Status

After powering on the device

1. LED flashes once after powering on, then turn OFF
2. After 10 seconds, LED flashes quickly for 2 seconds, indicating it has joined the network
3. After joining the network, the LED stays off to save energy
4. Push the reset button to re-join the network if the LED does not start flashing 15 seconds after powering on

3.3.3 Connect to the Gateway (LPS8) and TTN Server

Typically, The LoRaWAN gateway needs to set the server address and uplink and downlink channel parameters for the end device. Refer to the gateway user manual to configure the server. Here, a common LoRaWAN Gateway (LPS8-915MHz) is taken as an example to explain how to configure the communication parameters of the Sensor Node.

You can learn more about LPS8 Gateway:

<https://www.seeedstudio.com/LPS8-Indoor-LoRaWAN-Gateway-Included-SX1308-LoRa-Concentrator-p-4251.html>

1) Gateway Registration on TTN

TTN website: <https://www.thethingsnetwork.org>

Follow the instruction to create your account, and access “Console”.

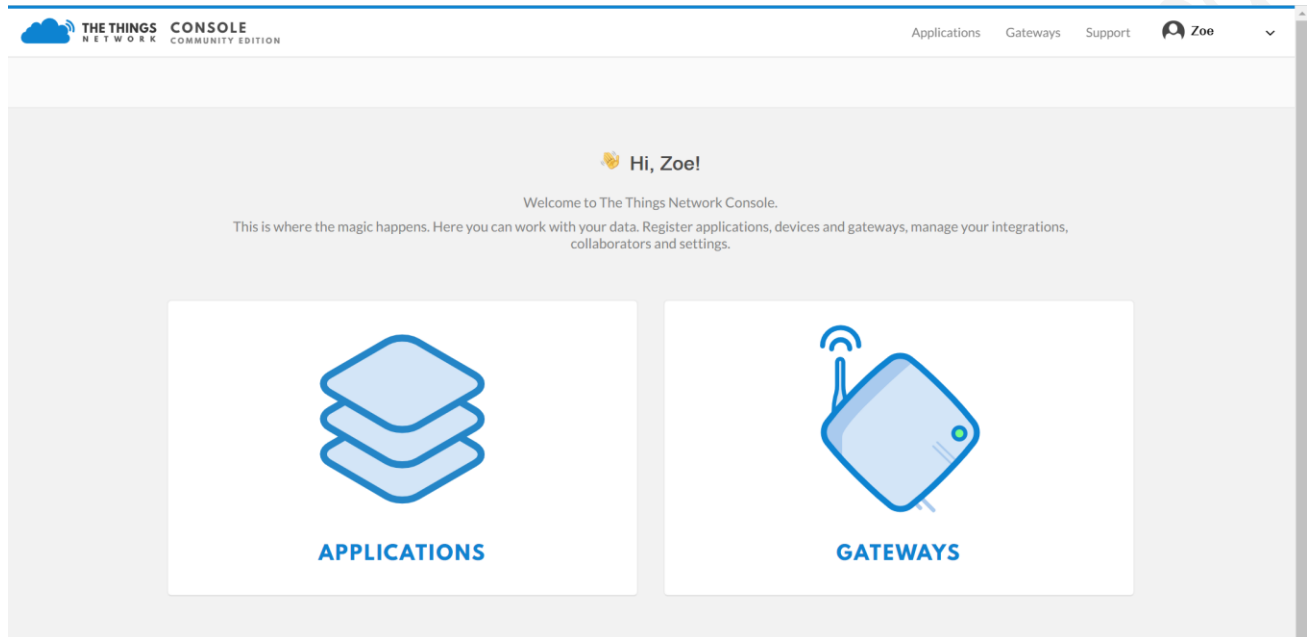

Register Gateway:

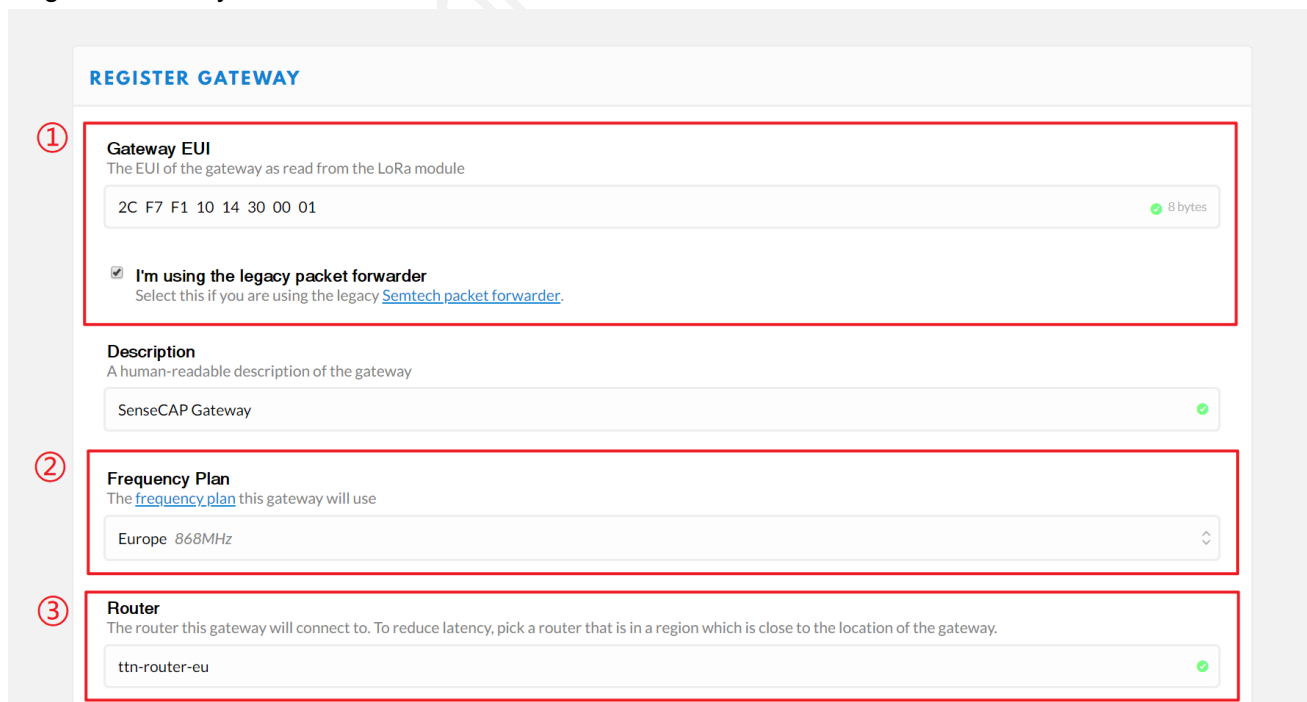

REGISTER GATEWAY

① **Gateway EUI**
The EUI of the gateway as read from the LoRa module
2C F7 F1 10 14 30 00 01 8 bytes
 I'm using the legacy packet forwarder
Select this if you are using the legacy [Semtech packet forwarder](#).

Description
A human-readable description of the gateway
SenseCAP Gateway

② **Frequency Plan**
The [frequency plan](#) this gateway will use
Europe 868MHz

③ **Router**
The router this gateway will connect to. To reduce latency, pick a router that is in a region which is close to the location of the gateway.
ttn-router-eu

① Gateway EUI: View the labels on the gateway.

Select 'I'm using the legacy packet forwarder'.

- ② Frequency Plan: View the labels on the gateway.
- ③ Router: Select the router that is right for you.
- ④ Register.

Gateway Status displays connected, indicating successful registration.

GATEWAY OVERVIEW
⚙ settings

Gateway ID eui-2cf7f11014300001

Description SenseCAP Gateway

Owner  Zoe [Transfer ownership](#)

Status ● connected

Frequency Plan Europe 868MHz

Router ttn-router-eu

Gateway Key base64 

Last Seen 6 seconds ago

Received Messages 102608

Transmitted Messages 7880

2) Create an Application

TTN console → Application → Add application

- ① Application ID: Enter a unique name.
- ② Description: Enter a description.
- ③ Handler registration: Select the same handler as the gateway router.
- ④ Add application.

ADD APPLICATION

Application ID ①

The unique identifier of your application on the network

Description ②

A human readable description of your new app

Application EUI

An application EUI will be issued for The Things Network block for convenience, you can add your own in the application settings page.

EUI issued by The Things Network

Handler registration ③

Select the handler you want to register this application to

Cancel Add application

- ① Application → Application EUIS → Manage EUIs.
- ② →Add EUI.
- ③ Enter the node's AppEui that you got in the 3.1 step.
- ④ →Add EUI.

APPLICATION OVERVIEW

[documentation](#)

Application ID sensecap-node

Description sensecap add node

Created 30 minutes ago

Handler ttn-handler-eu *(current handler)*

APPLICATION EUIS

① → ⚙️ manage_euis

<> ↔ 70 B3 D5 7E D0 02 C7 FE 📄

Applications > sensecap-node > Settings

Overview | Devices | Payload Formats | Integrations | Data | Settings

APP SETTINGS

- General
- EUIs**
- Collaborators
- Access Keys

EUIs ② → + add EUI

70 B3 D5 7E D0 02 C7 FE 📄
- remove

Applications > sensecap-node > Settings

Overview | Devices | Payload Formats | Integrations | Data | Settings

APP SETTINGS

- General
- EUIs**
- Collaborators
- Access Keys

EUIs ③

Add EUI

≡

✔ 8 bytes

Cancel Add EUI

3) Sensor Node Registration on TTN

Application → Devices → register device

DEVICES → + register device ⚙️ manage devices

0 registered devices

- ① Device ID: Enter a unique name.
- ② Device EUI: Enter the node's Device EUI that you got in the previous step.
- ③ App Key: Enter the node's App Key that you got in the previous step.
- ④ App EUI: Select the node's App EUI.
- ⑤ Register.

REGISTER DEVICE
[bulk import devices](#)

Device ID ①

This is the unique identifier for the device in this app. The device ID will be immutable.

Device EUI ②

The device EUI is the unique identifier for this device on the network. You can change the EUI later.

8 bytes

App Key ③

The App Key will be used to secure the communication between you device and the network.

16 bytes

App EUI ④

Cancel Register

4) Gateway Settings

Find radio settings or frequency settings in the background of the gateway.

Configure the gateway as Sub-band 2. Please refer to the Configuration Overview for channel settings.

dragino-1d1694
Status ▾
System ▾
Network ▾
Service ▾
Logout

LoRa Gateway Settings

Configuration to communicate with LoRa devices and LoRaWAN server

General Settings
Radio Settings
Channels Settings

radio 0 enable

Radio_0 frequency

Radio_0 for tx

Radio_0 tx min frequency

Radio_0 tx max frequency

radio 1 enable

Radio_1 frequency

Radio_1 for tx

Save & Apply
Save
Reset

LoRa Gateway Settings

Configuration to communicate with LoRa devices and LoRaWAN server

[General Settings](#)
[Radio Settings](#)
[Channels Settings](#)

 multiSF channel 0 enable

 multiSF channel 0 radio

 multiSF channel 0 IF

 multiSF channel 1 enable

 multiSF channel 1 radio

 multiSF channel 1 IF

 multiSF channel 2 enable

 multiSF channel 2 radio

 multiSF channel 2 IF

 multiSF channel 3 enable

 multiSF channel 3 radio

 multiSF channel 3 IF

 multiSF channel 4 enable

 multiSF channel 4 radio

 multiSF channel 4 IF

 multiSF channel 5 enable

 multiSF channel 5 radio

 multiSF channel 5 IF

 multiSF channel 6 enable

 multiSF channel 6 radio

 multiSF channel 6 IF

 multiSF channel 7 enable

 multiSF channel 7 radio

 multiSF channel 7 IF

 lorastd channel enable

 LoRa channel radio

 LoRa channel IF

 LoRa channel SF

 LoRa channel BW

5) Power on

Refer to the previous steps.

6) Checking Data on the TTN

On the Device Overview page, Status turns green.

DEVICE OVERVIEW

Application ID sensecap-node

Device ID th-sensor

Activation Method OTAA

Device EUI <> ⇄ 2C F7 F1 20 14 70 02 97 📄

Application EUI <> ⇄ 80 00 00 00 00 00 00 06 📄

App Key <> ⇄ 👁️ 📄

Device Address <> ⇄ 26 01 25 2D 📄

Network Session Key <> ⇄ 👁️ 📄

App Session Key <> ⇄ 👁️ 📄

Status ● 21 seconds ago

Frames up 0 [reset frame counters](#)

Frames down 0

On the Data page, data package is uploaded. For the format of the payload, refer to the Decoding section.

Applications > sensecap-node > Devices > th-sensor > Data

Overview **Data** Settings

APPLICATION DATA || pause 🗑️ clear

Filters uplink downlink activation ack error

time	counter	port		payload
▲ 19:25:48	4	2	retry confirmed	payload: 01 01 10 90 65 00 00 01 02 10 78 E6 00 00 92 AF
▼ 19:25:47		0		
▲ 19:25:47	4	2	confirmed	payload: 01 01 10 90 65 00 00 01 02 10 78 E6 00 00 92 AF
▲ 19:25:25	3	2		payload: 01 06 00 00 00 00 00 2F 87
▼ 19:25:05		0		
▲ 19:25:04	2	2	confirmed	payload: 01 06 00 00 00 00 00 2F 87
▼ 19:24:48		0		
▲ 19:24:47	1	2	confirmed	payload: 01 06 00 00 00 00 00 2F 87
▼ 19:24:30		0		
▲ 19:24:29	0	2	confirmed	payload: 00 00 00 03 03 00 02 00 07 00 4A 00 3C 00 01 01 00 00 01 00 01 01 02 00 99 00 30 12 01 03 00
⚡ 19:24:19 dev addr: 26 01 27 DB app eui: 80 00 00 00 00 00 00 06 dev eui: 2C F7 F1 20 14 70 02 97				

4 How to Modify the Key Parameters

4.1 Preparation

Tools	USB to TTL Serial Tool *1
Software	SenseCAP Node Configuration Tool Windows: SenseCAP-Node-Configuration-Tool-x.x.x.exe Mac: SenseCAP-Node-Configuration-Tool-x.x.x.dmg Download: https://github.com/Seeed-Solution/SenseCAP-Node-Configuration-Tool/releases/tag/v1.0.3

Connect serial ports (as shown in the image below), turn on the power, launch the serial port monitoring tool on your computer.

USB to TTL Serial Tool	Sensor Node
RX	TX
TX	RX
GND	GND
Baud Rates	115200

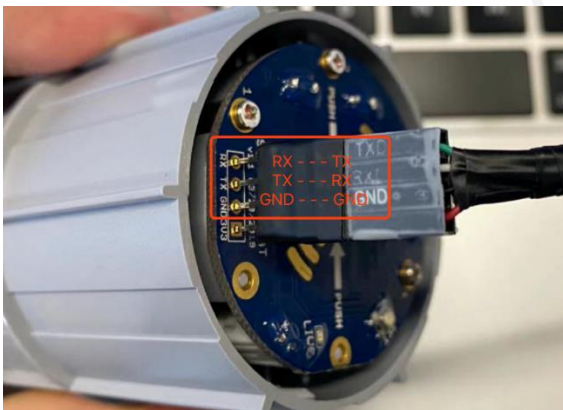

Install the SenseCAP Node Configuration Tool.

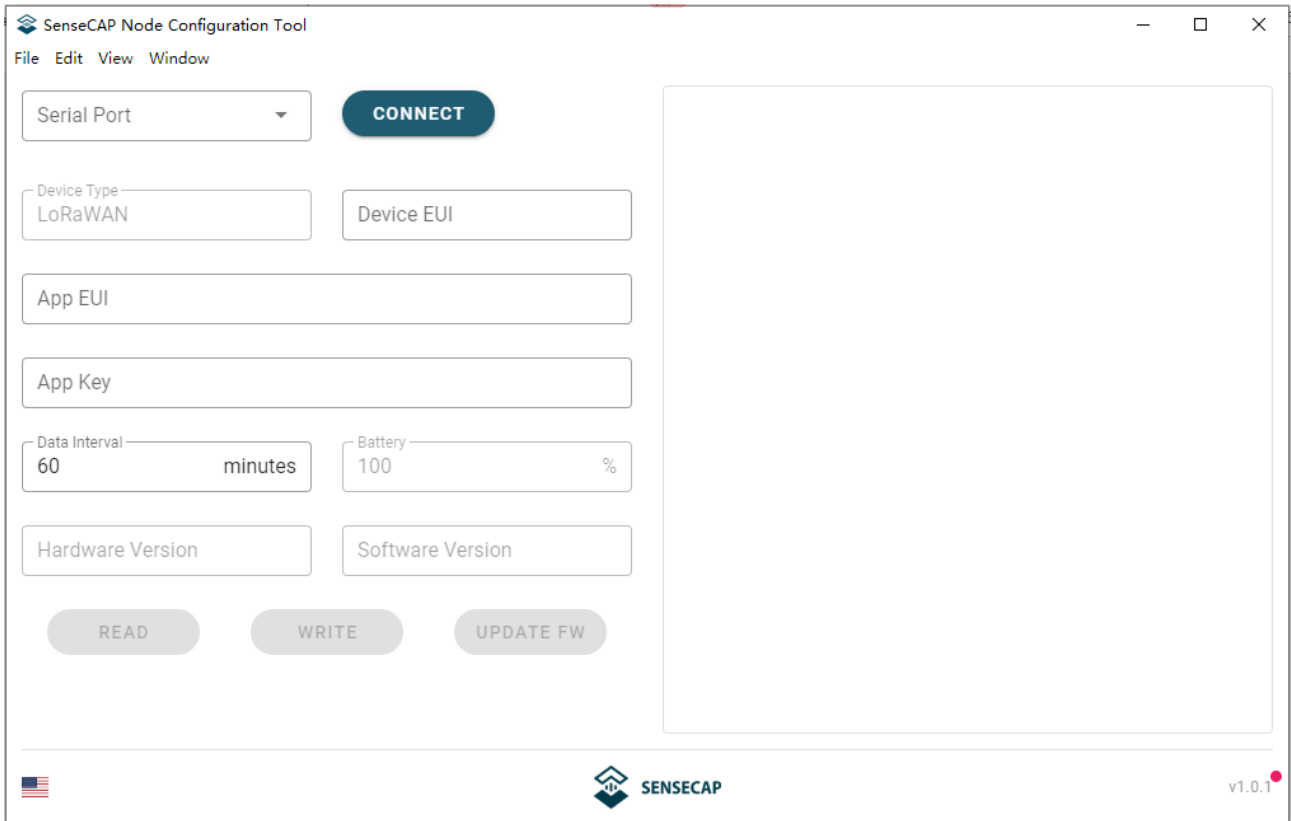

Select the COM Port that your tool uses, and click “CONNECT”. Power the Sensor Node.

Press “SET” button on the Sensor Controller, meanwhile press “RESET” once, and you will see “SenseCAP”.

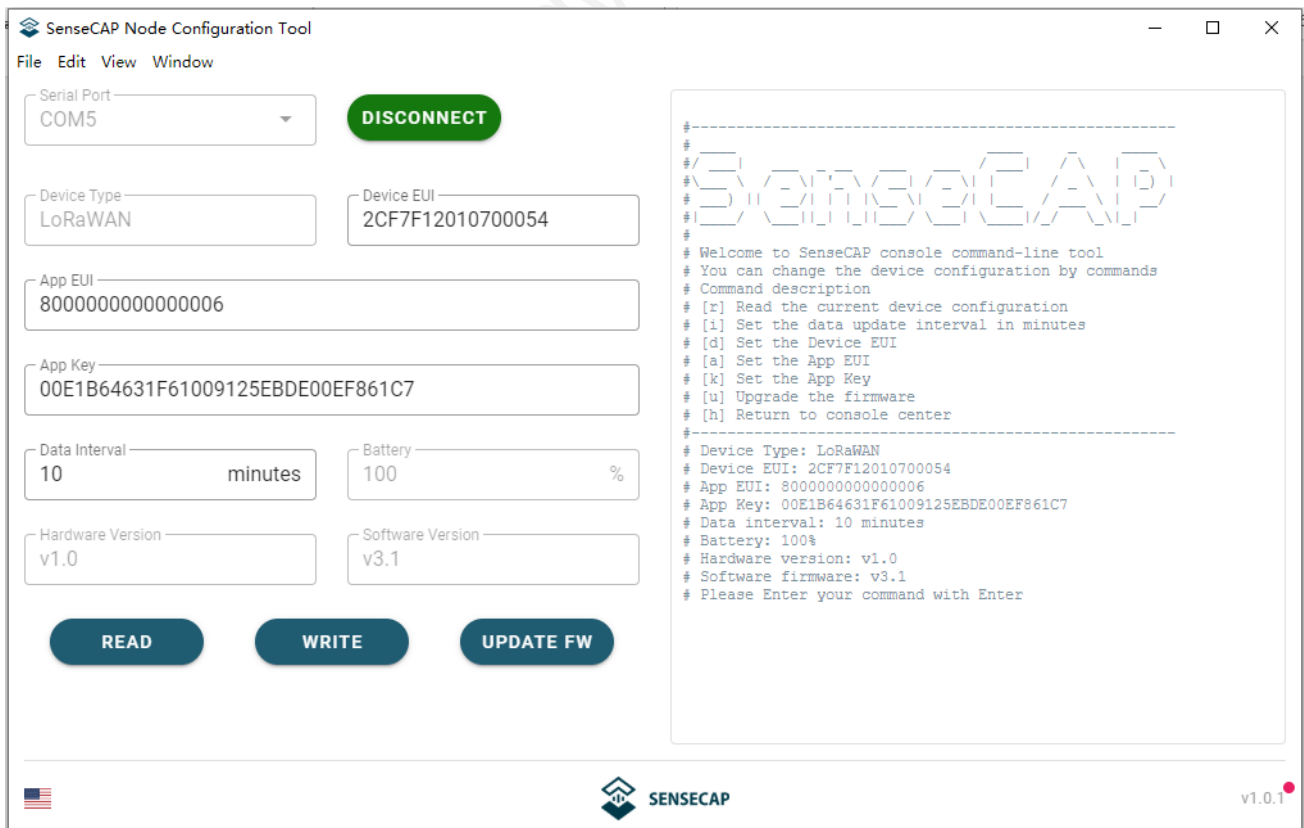

4.2 Modify the Device EUI, App EUI & Key and Data Interval

(1) ① Device EUI (16 bit)

② App EUI (16 bit)

③ App Key (32 bit)

④ Data Interval (Sensor collection cycle)

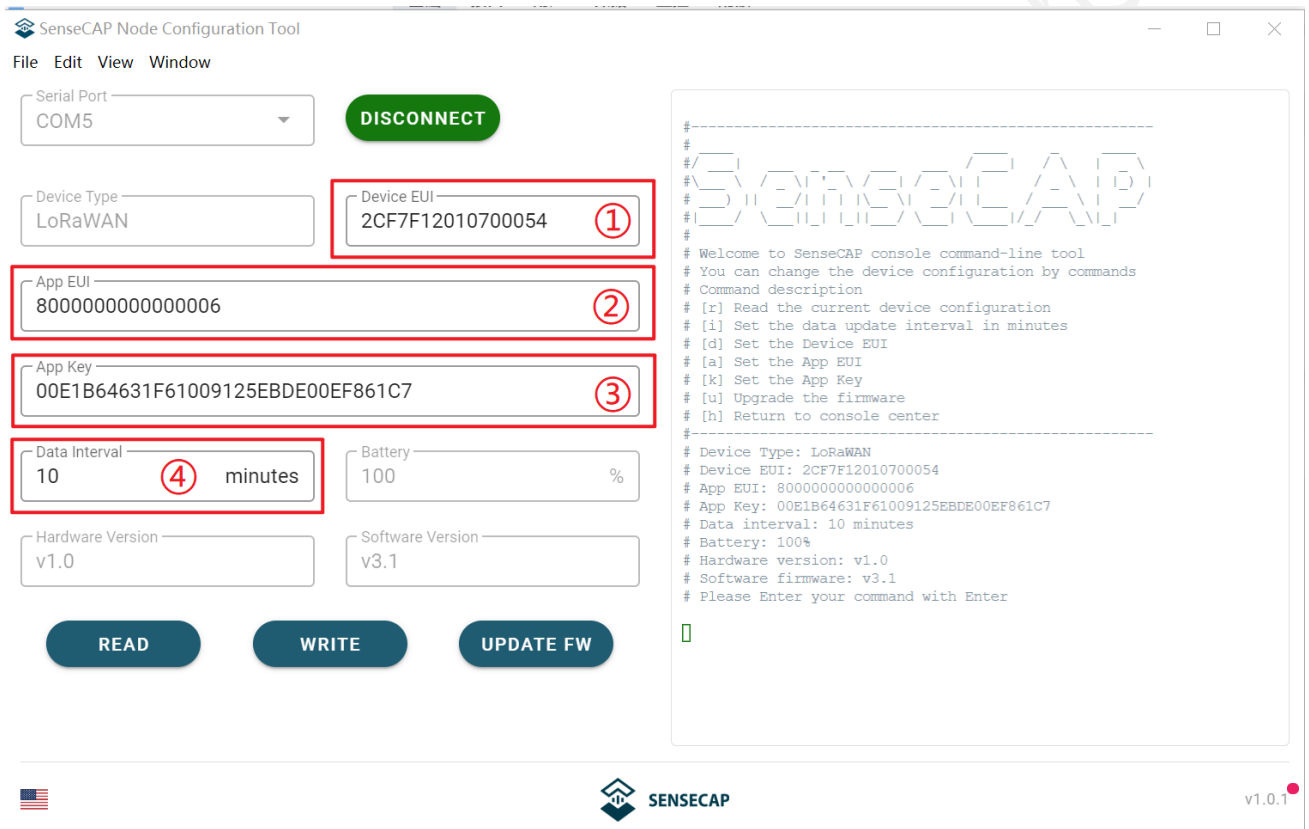

SenseCAP Node Configuration Tool

File Edit View Window

Serial Port: COM5 **DISCONNECT**

Device Type: LoRaWAN Device EUI: 2CF7F12010700054 ①

App EUI: 8000000000000006 ②

App Key: 00E1B64631F61009125EBDE00EF861C7 ③

Data Interval: 10 ④ minutes Battery: 100 %

Hardware Version: v1.0 Software Version: v3.1

READ WRITE UPDATE FW

```

#-----
#
# \
# /
# SENSECAP
# /
# \
#-----
# Welcome to SenseCAP console command-line tool
# You can change the device configuration by commands
# Command description
# [r] Read the current device configuration
# [i] Set the data update interval in minutes
# [d] Set the Device EUI
# [a] Set the App EUI
# [k] Set the App Key
# [u] Upgrade the firmware
# [h] Return to console center
#-----
#
# Device Type: LoRaWAN
# Device EUI: 2CF7F12010700054
# App EUI: 8000000000000006
# App Key: 00E1B64631F61009125EBDE00EF861C7
# Data interval: 10 minutes
# Battery: 100%
# Hardware version: v1.0
# Software firmware: v3.1
# Please Enter your command with Enter
    
```

USA SENSECAP v1.0.1

(2) For example: modify the Device EUI

① Write the new Device EUI.

② Click "WRITE"

SenseCAP Node Configuration Tool

File Edit View Window

Serial Port: COM5 **DISCONNECT**

Device Type: LoRaWAN **1** Device EUI: 2CF7F12010700054

App EUI: 8000000000000006

App Key: 00E1B64631F61009125EBDE00EF861C7

Data Interval: 10 minutes Battery: 100 %

Hardware Version: v1.0 Software Version: v3.1 **2** **WRITE** **UPDATE FW** **READ**

```
#-----  
#  
# SENSECAP  
#  
# Welcome to SenseCAP console command-line tool  
# You can change the device configuration by commands  
# Command description  
# [r] Read the current device configuration  
# [i] Set the data update interval in minutes  
# [d] Set the Device EUI  
# [a] Set the App EUI  
# [k] Set the App Key  
# [u] Upgrade the firmware  
# [h] Return to console center  
#-----  
# Device Type: LoRaWAN  
# Device EUI: 2CF7F12010700054  
# App EUI: 8000000000000006  
# App Key: 00E1B64631F61009125EBDE00EF861C7  
# Data interval: 10 minutes  
# Battery: 100%  
# Hardware version: v1.0  
# Software firmware: v3.1  
# Please Enter your command with Enter  
#
```

USA  SENSECAP v1.0.1

4.3 Modify the Sub-band

Example:

You can type commands at the green cursor: b

Set the sub-band to 7: 7

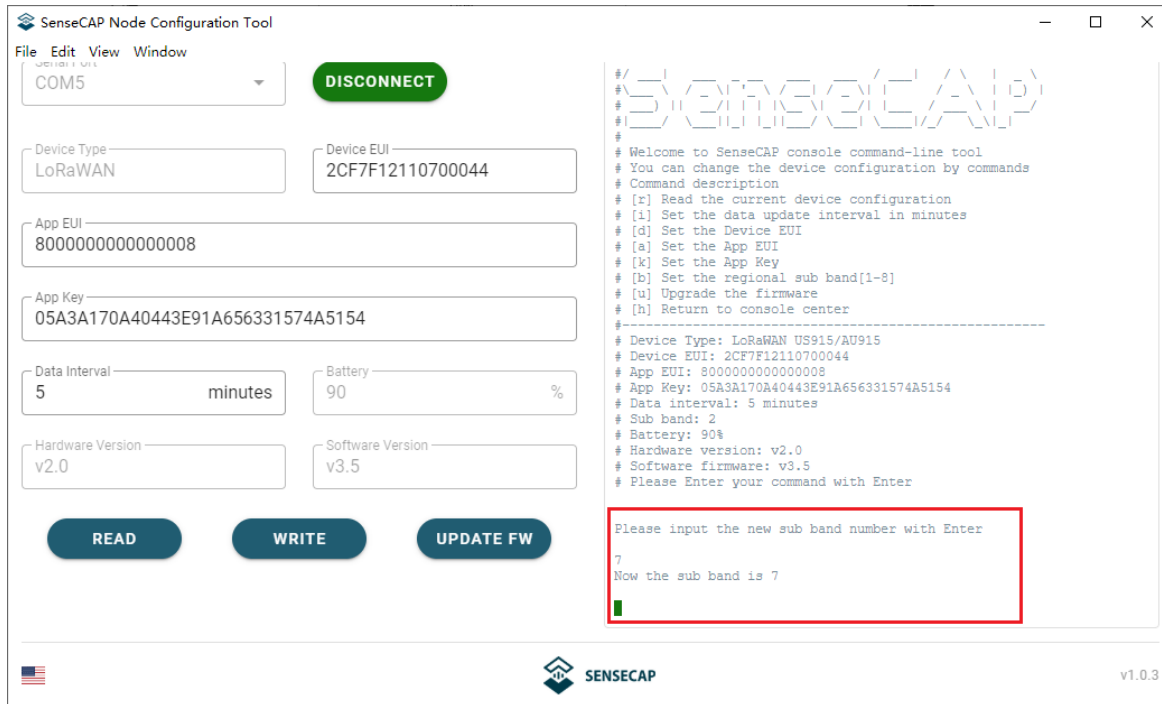

The screenshot shows the 'SenseCAP Node Configuration Tool' interface. On the left, there are configuration fields for Device Type (LoRaWAN), Device EUI (2CF7F1211070044), App EUI (8000000000000008), App Key (05A3A170A40443E91A656331574A5154), Data Interval (5 minutes), Battery (90%), Hardware Version (v2.0), and Software Version (v3.5). There are buttons for 'DISCONNECT', 'READ', 'WRITE', and 'UPDATE FW'. On the right, a terminal window displays the SenseCAP console command-line tool. The terminal shows the current configuration: Device Type: LoRaWAN US915/AU915, Device EUI: 2CF7F1211070044, App EUI: 8000000000000008, App Key: 05A3A170A40443E91A656331574A5154, Data interval: 5 minutes, Sub band: 2, Battery: 90%, Hardware version: v2.0, Software firmware: v3.5. A red box highlights the prompt 'Please input the new sub band number with Enter' where the user has entered '7'. The terminal output shows 'Now the sub band is 7'.

4.4 Modify the Data Interval Remotely

(1) Using the Network Server's portal or API to send downlink command, then the Node will respond to the ack.

Note: The downlink command takes effect and responds the next time the node uploads data.

(2) Downlink as follow:

0x00	0x89	0x00	prepareId_L	prepareId_H	duty_L	duty_H	crc-L	crc-H
------	------	------	-------------	-------------	--------	--------	-------	-------

0x00	Fixed field
0x89	Fixed field
0x00	Fixed field
prepareId_L	Command ID low byte, you can customize the values, it allow each command ID to be the same
prepareId_H	Command ID high byte, you can customize the values, it allow each command ID to be the same
duty_L	Data interval low byte, you can set the data interval, unit: minute
duty_H	Data interval high byte, you can set the data interval, unit: minute
crc-L	CRC low byte, it's calculated by the CRC-16/CCITT
crc-H	CRC low byte, it's calculated by the CRC-16/CCITT

(3) When you send the downlink command, the Node responds to the ack command.

0x00	0x1F	0x00	prepareId_L	prepareId_H	result	0x00	crc-L	crc-H
------	------	------	-------------	-------------	--------	------	-------	-------

0x00	Fixed field
0x1F	Fixed field
0x00	Fixed field
prepareId_L	Command ID low byte, it is the same as the downlink command
prepareId_H	Command ID high byte, it is the same as the downlink command
result	If the downlink command is in force, it responds 0x01, else it responds 0x00
0x00	Fixed field
crc-L	CRC low byte, it's calculated by the CRC-16/CCITT
crc-H	CRC low byte, it's calculated by the CRC-16/CCITT

FPort = 2

For example: Set the Node's data interval is 10 minutes.

Send the downlink command (HEX):

00 89 00 11 22 0A 00 38 B4

0x00	0x89	0x00	prepareId_L	prepareId_H	duty_L	duty_H	crc-L	crc-H
00	89	00	11	22	0A	00	38	B4

ACK Response:

00 1F 00 11 22 01 00 78 0F

0x00	0x1F	0x00	prepareId_L	prepareId_H	result	0x00	crc-L	crc-H
00	1F	00	11	22	01	00	78	0F

5 Decoding

TTN payload decoding script for SenseCAP LoRaWAN:

<https://github.com/Seeed-Solution/TTN-Payload-Decoder/>

In the gateway or server background, similar packets can be viewed. (If the data is encrypted, it usually needs to be decrypted using base64)

APPLICATION DATA || pause 🗑 clear

Filters: uplink downlink activation ack error

time	counter	port		
▼ 11:19:12		0		
▲ 11:19:16	5	2	confirmed	payload: 01 01 10 B0 68 00 00 01 02 10 88 F4 00 00 8C FF Measurement Data packets
▼ 11:18:38		0		
▲ 11:19:02	4	2	confirmed	payload: 00 19 00 58 68 43 00 00 00 AB 5E
▼ 11:18:42		0		Initial Packets
▲ 11:18:46	3	2	confirmed	payload: 01 06 00 00 00 00 00 2F 87
▼ 11:18:28		0		
▲ 11:18:32	2	2	confirmed	payload: 00 00 00 01 01 00 01 00 07 00 64 00 05 00 01 01 00 01 01 00 01 01 02 00 54 00 00 15 01 03 00 30
▼ 11:18:15		0		
▲ 11:18:19	1	2	confirmed	payload: 00 00 00 00 00 00 00 00 00
▼ 11:17:57		0		
▲ 11:18:01	0	2	confirmed	payload: 00 00 00 00 00 00 00 00 00
⚡ 11:17:52				dev addr: 26 02 22 C0 appeui: 80 00 00 00 00 00 00 08 deveui: 2C F7 F1 21 10 70 00 54

Note:

With successful access to the network, please connect the Sensor Probe back to the Sensor Node Controller by turning it clockwise. Please note the labels on both sides should be aligned as the image below, or it will not be put back in the right way. When the Sensor Probe is connected to the Sensor Node Controller correctly, the device can upload data.

5.1 Packet Parsing

Packet Initialization

After being powered on or reboot, SenseCAP Sensor Nodes will be connected to the network using the OTAA activation method. Each Sensor Node will send data packets to the server, including the following data:

Initial packets (no need to learn about these initial packets)

- One packet with device info including hardware version, software version, battery level, sensor hardware & software version, sensor EUI, power, and sensor power time counter at each channel.

Measurement data packets

The only thing we should pay attention to is the sensor measurement data packets

APPLICATION DATA							pause	🗑️ cle
Filters								
	uplink	downlink	activation	ack	error			
time	counter	port						
▼ 11:19:12		0						
▲ 11:19:16	5	2	confirmed	payload: 01 01 10 B0 68 00 00 01 02 10 88 F4 00 00 8C FF	Measurement data packets			
▼ 11:18:58		0						

Packet Structure

The structure of the frame is shown in the image below.

channel	frame type	frame content
1 byte	2 bytes	≥ 4 bytes

1 byte for channel, default as 1, means the sensor has been well connected.

2 bytes for frame type, in this case, it will be 0110 and 0210, means temperature value and humidity value

4 bytes for content, is the sensor value with CRC

The frame content is sent in **little-endian byte order**

5.1.1 Example 1 - Air Temperature & Humidity Sensor:

Air Temperature & Humidity Sensor measurement packet: 010110B068000001021088F400008CFF

Divide the data into 3 sections

1	Air Temperature	010110B0680000	<p>01 is the channel number.</p> <p>0110 is 0x1001 (<i>little-endian byte order</i>) , which is the measurement ID for air temperature.</p> <p>B0680000 is actually 0x000068B0, whose equivalent decimal value is 26800. Divide it by 1000, and you' ll get the actual measurement value for air temperature as 26.8°C.</p>
2	Air Humidity	01021088F40000	<p>0210 is 0x1002 (<i>little-endian byte order</i>) , which is the measurement ID for air humidity.</p> <p>88F40000 is actually 0x0000F488, whose equivalent decimal value is 62600. Divide it by 1000, and you' ll get the actual measurement value for air humidity as 62.6%RH.</p>
3	CRC	8CFF	The CRC verification part.

5.1.2 Example 2 - CO2 Sensor:

CO2 Sensor measurement packet: 010410E08D05009802

Divide the data into 3 sections

1	CO2	010410E08D0500	<p>01 is the channel number.</p> <p>0410 is 0x1004 (<i>little-endian byte order</i>) , which is the measurement ID for CO2.</p>
---	-----	----------------	---

			E08D0500 is actually 0x00058DE0, whose equivalent decimal value is 364000. Divide it by 1000, and you' ll get the actual measurement value for CO2 as 364ppm .
3	CRC	9802	The CRC verification part.

5.1.3 Example 3 - Soil Moisture and Temperature Sensor:

Soil Moisture and Temperature Sensor measurement packet: **010610007D0000010710725100009A21**

Divide the data into 3 sections

1	Soil Temperature	010610007D0000	<p>01 is the channel number.</p> <p>0710 is 0x1007 (<i>little-endian byte order</i>) , which is the measurement ID for soil temperature.</p> <p>007D0000 is actually 0x00007D00, whose equivalent decimal value is 32000. Divide it by 1000, and you' ll get the actual measurement value for Soil Temperature as 32.0°C.</p>
2	Soil Moisture	01071072510000	<p>0710 is 0x1007 (<i>little-endian byte order</i>) , which is the measurement ID for soil moisture.</p> <p>72510000 is actually 0x00005172, whose equivalent decimal value is 20850. Divide it by 1000, and you' ll get the actual measurement value for Soil</p>

			Moisture as 20.85%.
3	CRC	9A21	The CRC verification part.

5.1.4 Example 4 – Light Intensity Sensor:

Light Intensity Sensor measurement packet: 010310A0320000C3B6

Divide the data into 3 sections

1	Light Intensity	010310A0320000	<p>01 is the channel number.</p> <p>0310 is 0x1003 (<i>little-endian byte order</i>), which is the measurement ID for Light Intensity.</p> <p>A0320000 is actually 0x000032A0, whose equivalent decimal value is 12960. Divide it by 1000, and you'll get the actual measurement value for Light Intensity as 12.96Lux.</p>
3	CRC	C3B6	The CRC verification part.

5.1.5 Example 5 – Barometric Pressure Sensor:

Barometric Pressure Sensor measurement packet: 010510284A140652B7

Divide the data into 3 sections

1	Barometric Pressure	010510284A1406	<p>01 is the channel number.</p> <p>0510 is 0x1003 (<i>little-endian byte order</i>), which is the measurement ID for Barometric Pressure.</p>
---	---------------------	----------------	--

			284A1406 is actually 0x06144A28, whose equivalent decimal value is 101993000. Divide it by 1000, and you' ll get the actual measurement value for Barometric Pressure as 101993 Pa .
3	CRC	52B7	The CRC verification part.

5.1.6 Example 5 – Soil Temperature, VWC & EC Sensor:

Soil Temperature, VWC & EC Sensor measurement packet:

011010007D0000010E1072510000010F10123100009A21

Divide the data into 3 sections

1	Soil Temperature	011010007D0000	<p>01 is the channel number.</p> <p>1010 is 0x1007 (<i>little-endian byte order</i>) , which is the measurement ID for soil temperature.</p> <p>007D0000 is actually 0x00007D00, whose equivalent decimal value is 32000. Divide it by 1000, and you' ll get the actual measurement value for Soil Temperature as 32.0°C.</p>
2	Soil Moisture	010E1072510000	<p>0E10 is 0x1007 (<i>little-endian byte order</i>) , which is the measurement ID for soil moisture.</p> <p>72510000 is actually 0x00005172, whose equivalent decimal value is 20850. Divide it by 1000, and you' ll get the actual measurement value for Soil Moisture as 20.85%.</p>

3	Soil EC	010F1012310000	<p>01 is the channel number.</p> <p>0F10 is 0x100C (<i>little-endian byte order</i>) , which is the measurement ID for soil EC.</p> <p>12310000 is actually 0x00003112, whose equivalent decimal value is 12562. Divide it by 1000, and you' ll get the actual measurement value for Soil Temperature as 12.562 dS/m.</p>
3	CRC	9A21	The CRC verification part.

5.2 Battery Information

Please note the counter number. After 10 packets, it will follow one special packet with battery info. You can either ignore this packet or get rid of the battery info in your code.

APPLICATION DATA || pause 🗑 clear

Filters: uplink downlink activation ack error

time	counter	port		
11:54:22		0		
11:54:26	12	2	confirmed	payload: 01 01 10 58 66 00 00 01 02 10 0C F8 00 00 68 85
11:49:21		0		
11:49:25	11	2	confirmed	payload: 00 07 00 64 00 05 00 01 01 10 58 66 00 00 01 02 10 70 F8 00 00 44 3E
11:44:19		0		
11:44:23	10	2	confirmed	payload: 01 01 10 58 66 00 00 01 02 10 00 FA 00 00 E4 A7
11:39:18		0		
11:39:22	9	2	confirmed	payload: 01 01 10 58 66 00 00 01 02 10 38 F9 00 00 AA E1
11:34:16		0		
11:34:21	8	2	confirmed	payload: 01 01 10 BC 66 00 00 01 02 10 A8 F7 00 00 BF FC

Original Info: 000700640005000101105866000001021070F80000443E

Battery Info: 00070064000500

Measurement Info: 0101105866000001021070F80000443E

Example:

Battery & TH Sensor measurement packet: 000700640005000101105866000001021070F80000443E

Divide the data into 3 sections

1	Battery	000700 6400 0500	
2	Temperature	01 0110 58660000	<p>01 is the channel number.</p> <p>0110 is 0x1001 (<i>little-endian byte order</i>), which is the measurement ID for air temperature.</p>

			<p>58660000 is actually 0x00006658, whose equivalent decimal value is 26200. Divide it by 1000, and you' ll get the actual measurement value for air temperature as 26.2°C.</p>
2	Humidity	01021070F80000	<p>0210 is 0x1002 (<i>little-endian byte order</i>) , which is the measurement ID for air humidity.</p> <p>70F80000 is actually 0x0000F870, whose equivalent decimal value is 63600. Divide it by 1000, and you' ll get the actual measurement value for air humidity as 63.6%RH.</p>
3	CRC	443E	The CRC verification part.

6 Device Installation

6.1 Installing Sensor Node

6.1.1 Installing the Sensor Node Bracket

Specially designed for installing SenseCAP Sensor Nodes, the bracket consists of a bracket and a sliding cap. With designated screw-holes, the bracket helps fasten the Sensor Node firmly onto a pole or a wall.

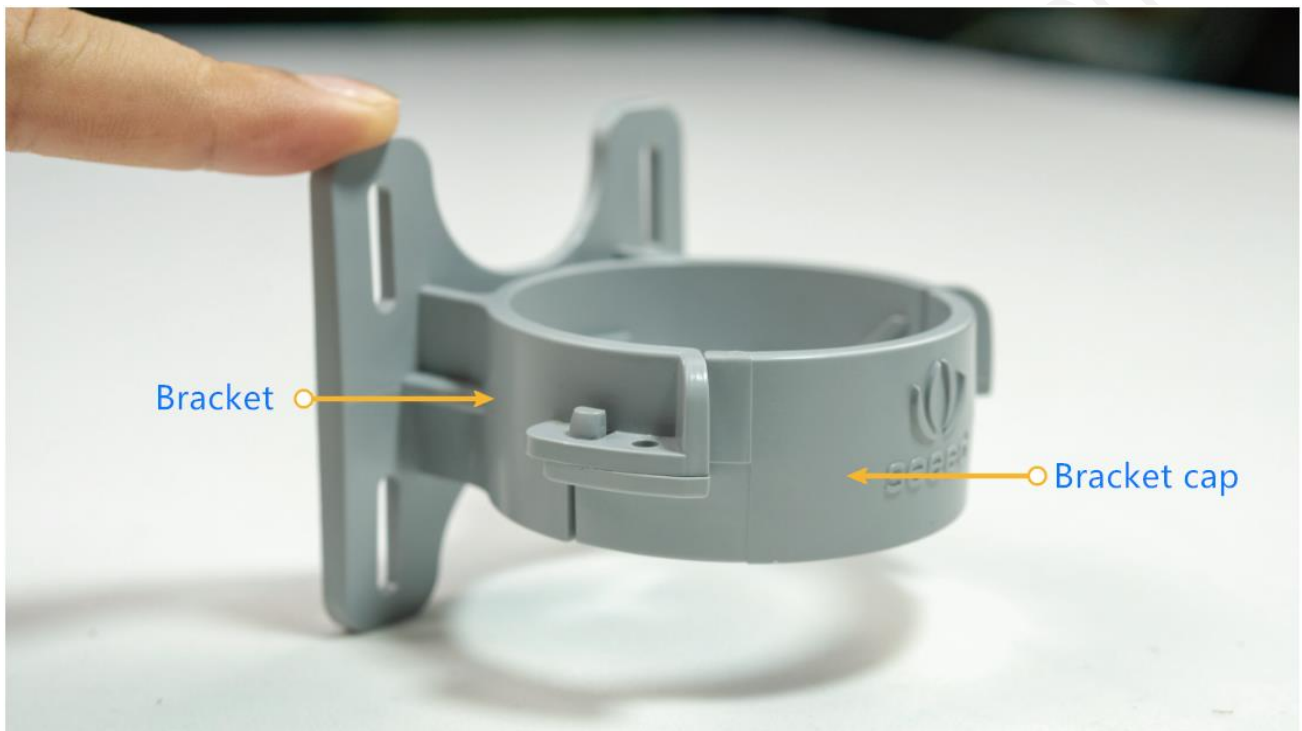

- 1) To install on a pole, you can use zip ties to fasten the bracket (recommended pole dimension is 50-70mm in diameter). Please refer to the following image for bracket directions.

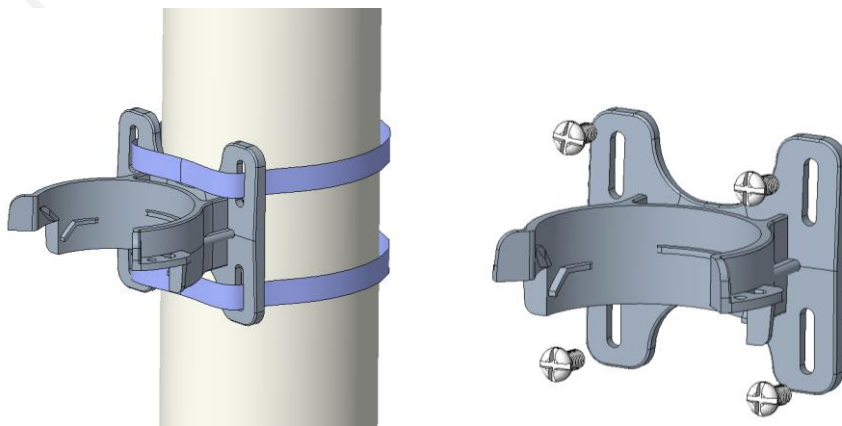

- 2) To install on the wall or other surfaces, you can use self-drilling screws to fasten the bracket onto the

surface.

6.1.2 Installing Sensor Nodes

After installing brackets, let's install sensors.

- 1) The Sensor Probe should be placed vertically downward with the label facing outward. Be consistent with the bracket gap. Make sure the circle part in the middle of Sensor Node is aligned with the middle of the bracket, and then press the Sensor Node to fit into the bracket. A click/snap sound indicates that the Sensor Node has been installed successfully. Try to manually twist it to make sure the Sensor Node is locked to the bracket securely.
- 2) Secure by fastening the bracket cap as instructed in the image.
- 3) Place two self-drilling screws on the bracket to increase firmness and help prevent theft.

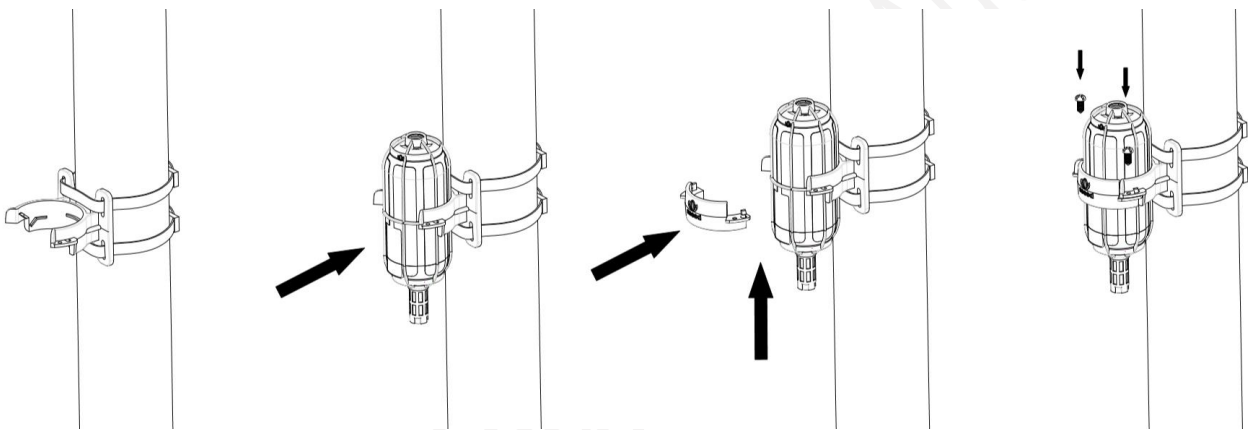

Note: Do not insert the Sensor Node into the bracket from the top, or it will not fasten the onto the bracket securely.

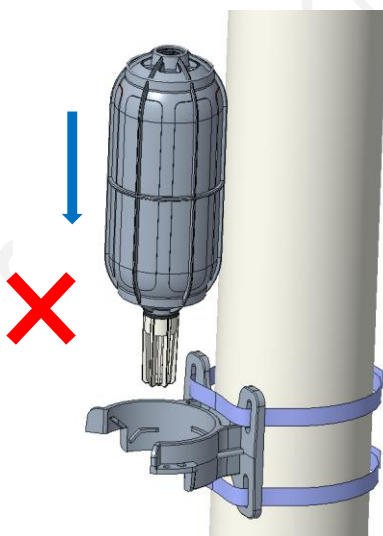

6.1.3 Dos and Don'ts in Installing Sensor Probes

The same instruction applies to installing the different Sensor Nodes. However, there are some tips to keep in mind when installing certain Sensor Nodes.

- **Light Sensor**

The Sensor Probe of the Light Sensor needs to be placed vertically upward, and there should not be anything obstructing sunlight from the Sensor Probe.

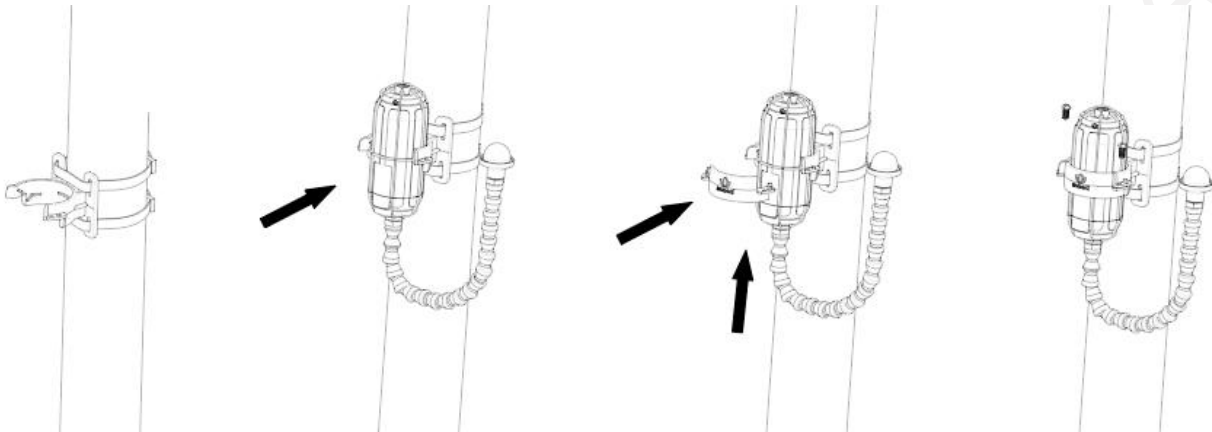

- **CO2 Sensor**

The Sensor Probe can be fastened with self-drilling screws. Please refer to the image below for the probe direction. The end without the cables should point downward to prevent rain or dust from getting into the probe. Also, the device should be in a place with good ventilation.

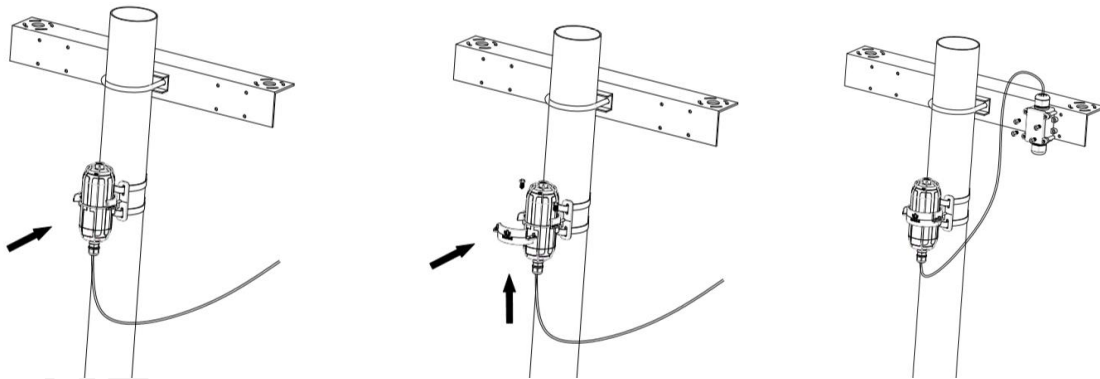

- **Use outdoors for a long time**

If the sensor has wires, install threaded tubes:



7 Trouble Shooting

7.1 Sensor Node not join the network, how to do?

1. Check the gateway channels configuration. Make sure the gateway and Sensor Node have the same uplink and downlink channels.
2. Check the gateway real-time log and RESET the sensor to see if there are any sensor data packets. If there are packets, check whether the gateway is sending downlink packets.
3. If the channels and other configurations are correct and the gateway logs do not have packets, please contact technical support.

7.2 Why is the new sensor's battery not 100%?

Battery power detection is not high-precision. Its principle is to measure the supply voltage, when the power is turned on and repeatedly RESET, the voltage is unstable, so it is not 100%. When the sensor is stable, the power will be more accurate.

7.3 Why can't I get into configuration mode with the USB to TTL serial tool?

1. Make sure the RX/TX/GND connection is correct.
2. Keep the pins in close contact during communication.
3. Operation of sensor entering configuration mode: Turn on the switch, long press SET, and press RESET at the same time.

7.4 Support

Support is provided Monday to Friday, from 09:00 to 18:00 GMT+8. Due to different time zones we cannot offer live support. However, your questions will be answered as soon as possible in the before-mentioned schedule.

Provide as much information as possible regarding your enquiry (product models, accurately describe your problem and steps to replicate it etc.) and send a mail to: sensecap@seeed.cc